

ADVANCED REAL ANALYSIS

Digital Second Edition
Corrected version 2017

Anthony W. Knapp

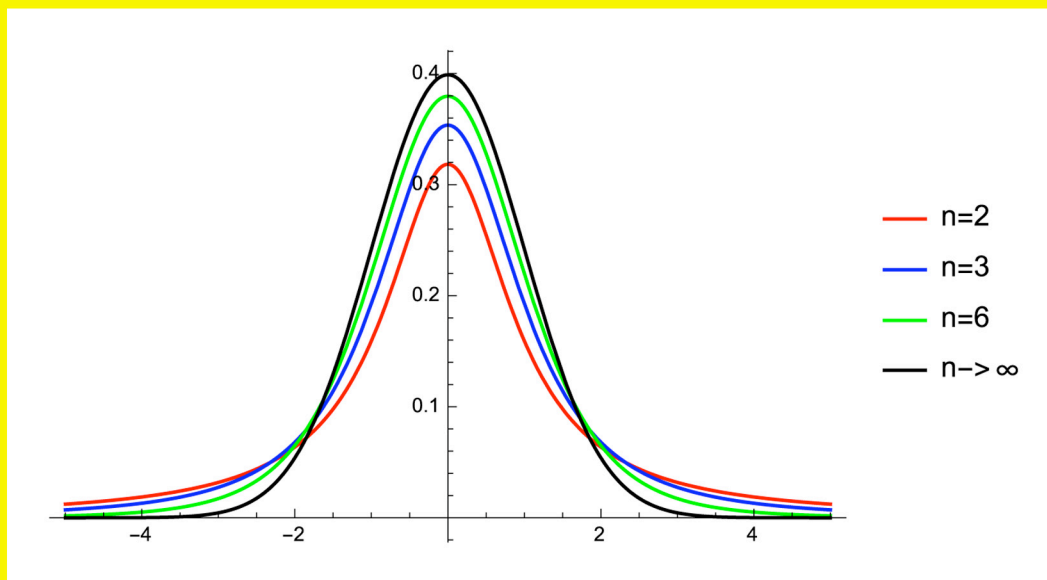

Advanced Real Analysis

Digital Second Editions
By Anthony W. Knapp

Basic Algebra

Advanced Algebra

Basic Real Analysis,
with an appendix “Elementary Complex Analysis”

Advanced Real Analysis

Anthony W. Knapp

Advanced Real Analysis

Along with a Companion Volume *Basic Real Analysis*

Digital Second Edition
Corrected version, 2017

Published by the Author
East Setauket, New York

Anthony W. Knapp
81 Upper Sheep Pasture Road
East Setauket, N.Y. 11733–1729, U.S.A.
Email to: aknapp@math.stonybrook.edu
Homepage: www.math.stonybrook.edu/~aknapp

Title: Advanced Real Analysis
Cover: Normal distribution as a limit of Gosset's t distribution; see page 421.

Mathematics Subject Classification (2010): 46–01, 42–01, 43–01, 35–01, 34–01, 47–01, 58–01, 60A99, 60F05, 28C10, 42C40, 65T60.

First Edition, ISBN-13 978-0-8176-4382-9
©2007 Anthony W. Knapp
Published by Birkhäuser Boston

Digital Second Edition, not to be sold, no ISBN
©2016 Anthony W. Knapp, corrected version issued in 2017
Published by the Author

All rights reserved. This file is a digital second edition of the above named book. The text, images, and other data contained in this file, which is in portable document format (PDF), are proprietary to the author, and the author retains all rights, including copyright, in them. The use in this file of trade names, trademarks, service marks, and similar items, even if they are not identified as such, is not to be taken as an expression of opinion as to whether or not they are subject to proprietary rights.

All rights to print media for the first edition of this book have been licensed to Birkhäuser Boston, c/o Springer Science+Business Media Inc., 233 Spring Street, New York, NY 10013, USA, and this organization and its successor licensees may have certain rights concerning print media for the digital second edition. The author has retained all rights worldwide concerning digital media for both the first edition and the digital second edition.

The file is made available for limited noncommercial use for purposes of education, scholarship, and research, and for these purposes only, or for fair use as understood in the United States copyright law. Users may freely download this file for their own use and may store it, post it online, and transmit it digitally for purposes of education, scholarship, and research. They may not convert it from PDF to any other format (e.g., EPUB), they may not edit it, and they may not do reverse engineering with it. In transmitting the file to others or posting it online, users must charge no fee, nor may they include the file in any collection of files for which a fee is charged. Any exception to these rules requires written permission from the author.

Except as provided by fair use provisions of the United States copyright law, no extracts or quotations from this file may be used that do not consist of whole pages unless permission has been granted by the author (and by Birkhäuser Boston if appropriate).

The permission granted for use of the whole file and the prohibition against charging fees extend to any partial file that contains only whole pages from this file, except that the copyright notice on this page must be included in any partial file that does not consist exclusively of the front cover page. Such a partial file shall not be included in any derivative work unless permission has been granted by the author (and by Birkhäuser Boston if appropriate).

Inquiries concerning print copies of either edition should be directed to Springer Science+Business Media Inc.

To Susan

and

To My Children, Sarah and William,

and

To My Real-Analysis Teachers:

Salomon Bochner, William Feller, Hillel Furstenberg,

Harish-Chandra, Sigurdur Helgason, John Kemeny,

John Lamperti, Hazleton Mirkil, Edward Nelson,

Laurie Snell, Elias Stein, Richard Williamson

CONTENTS

<i>Contents of Basic Real Analysis</i>	x
<i>Preface to the Second Edition</i>	xi
<i>Preface to the First Edition</i>	xiii
<i>List of Figures</i>	xvi
<i>Dependence Among Chapters</i>	xvii
<i>Guide for the Reader</i>	xviii
<i>Notation and Terminology</i>	xxiii
I. INTRODUCTION TO BOUNDARY-VALUE PROBLEMS	1
1. Partial Differential Operators	1
2. Separation of Variables	3
3. Sturm–Liouville Theory	19
4. Problems	31
II. COMPACT SELF-ADJOINT OPERATORS	34
1. Compact Operators	34
2. Spectral Theorem for Compact Self-Adjoint Operators	36
3. Hilbert–Schmidt Theorem	41
4. Unitary Operators	45
5. Classes of Compact Operators	46
6. Problems	52
III. TOPICS IN EUCLIDEAN FOURIER ANALYSIS	54
1. Tempered Distributions	54
2. Weak Derivatives and Sobolev Spaces	60
3. Harmonic Functions	69
4. \mathcal{H}^p Theory	80
5. Calderón–Zygmund Theorem	83
6. Applications of the Calderón–Zygmund Theorem	92
7. Multiple Fourier Series	96
8. Application to Traces of Integral Operators	97
9. Problems	99

IV. TOPICS IN FUNCTIONAL ANALYSIS	105
1. Topological Vector Spaces	106
2. $C^\infty(U)$, Distributions, and Support	112
3. Weak and Weak-Star Topologies, Alaoglu's Theorem	116
4. Stone Representation Theorem	121
5. Linear Functionals and Convex Sets	125
6. Locally Convex Spaces	128
7. Topology on $C_{\text{com}}^\infty(U)$	131
8. Krein–Milman Theorem	140
9. Fixed-Point Theorems	143
10. Gelfand Transform for Commutative C^* Algebras	146
11. Spectral Theorem for Bounded Self-Adjoint Operators	160
12. Problems	173
V. DISTRIBUTIONS	179
1. Continuity on Spaces of Smooth Functions	179
2. Elementary Operations on Distributions	187
3. Convolution of Distributions	189
4. Role of Fourier Transform	202
5. Fundamental Solution of Laplacian	206
6. Problems	207
VI. COMPACT AND LOCALLY COMPACT GROUPS	212
1. Topological Groups	213
2. Existence and Uniqueness of Haar Measure	220
3. Modular Function	230
4. Invariant Measures on Quotient Spaces	234
5. Convolution and L^p Spaces	237
6. Representations of Compact Groups	240
7. Peter–Weyl Theorem	251
8. Fourier Analysis Using Compact Groups	256
9. Problems	264
VII. ASPECTS OF PARTIAL DIFFERENTIAL EQUATIONS	275
1. Introduction via Cauchy Data	275
2. Orientation	283
3. Local Solvability in the Constant-Coefficient Case	292
4. Maximum Principle in the Elliptic Second-Order Case	296
5. Parametrices for Elliptic Equations with Constant Coefficients	300
6. Method of Pseudodifferential Operators	305
7. Problems	317

VIII. ANALYSIS ON MANIFOLDS	321
1. Differential Calculus on Smooth Manifolds	322
2. Vector Fields and Integral Curves	331
3. Identification Spaces	334
4. Vector Bundles	338
5. Distributions and Differential Operators on Manifolds	348
6. More about Euclidean Pseudodifferential Operators	355
7. Pseudodifferential Operators on Manifolds	361
8. Further Developments	366
9. Problems	370
IX. FOUNDATIONS OF PROBABILITY	375
1. Measure-Theoretic Foundations	375
2. Independent Random Variables	383
3. Kolmogorov Extension Theorem	390
4. Strong Law of Large Numbers	397
5. Convergence in Distribution	403
6. Portmanteau Lemma	406
7. Characteristic Functions	409
8. Lévy Continuity Theorem	411
9. Central Limit Theorem	412
10. Statistical Inference and Gosset's t Distribution	417
11. Problems	429
X. INTRODUCTION TO WAVELETS	434
1. Introduction	435
2. Haar Wavelet	443
3. Multiresolution Analysis	454
4. Shannon Wavelet	465
5. Construction of a Wavelet from a Scaling Function	468
6. Meyer Wavelets	472
7. Splines	476
8. Battle–Lemarié Wavelets	487
9. Daubechies Wavelets	498
10. Smoothness Questions	520
11. A Quick Introduction to Applications	528
12. Problems	540
<i>Hints for Solutions of Problems</i>	545
<i>Selected References</i>	603
<i>Index of Notation</i>	607
<i>Index</i>	611

CONTENTS OF *BASIC REAL ANALYSIS*

- I. Theory of Calculus in One Real Variable
- II. Metric Spaces
- III. Theory of Calculus in Several Real Variables
- IV. Theory of Ordinary Differential Equations and Systems
- V. Lebesgue Measure and Abstract Measure Theory
- VI. Measure Theory for Euclidean Space
- VII. Differentiation of Lebesgue Integrals on the Line
- VIII. Fourier Transform in Euclidean Space
- IX. L^p Spaces
- X. Topological Spaces
- XI. Integration on Locally Compact Spaces
- XII. Hilbert and Banach Spaces
- Appendix
- B. Elementary Complex Analysis

PREFACE TO THE SECOND EDITION

In the years since publication of the first editions of *Basic Real Analysis* and *Advanced Real Analysis*, many readers have reacted to the books by sending comments, suggestions, and corrections. They appreciated the overall comprehensive nature of the books, associating this feature with the large number of problems that develop so many sidelights and applications of the theory.

Along with the general comments and specific suggestions were corrections, and there were enough corrections to *Basic Real Analysis* to warrant a second edition. A second edition of *Advanced Real Analysis* was then needed for compatibility. As long as this volume was being changed, it seemed appropriate to add the two important topics that are listed below.

For the first editions, the author granted a publishing license to Birkhäuser Boston that was limited to print media, leaving the question of electronic publication unresolved. A major change with the second editions is that the question of electronic publication has now been resolved, and for each book a PDF file, called the “digital second edition,” is being made freely available to everyone worldwide for personal use. These files may be downloaded from the author’s own Web page and from elsewhere.

The two important additions to *Advanced Real Analysis* are as follows:

- Five sections on the Central Limit Theorem and an introduction to statistical inference. This material appears at the end of Chapter IX, “Foundations of Probability.” Four sections deal with the Central Limit Theorem itself. The fifth section shows how the Central Limit Theorem arises in applications to statistics as a limiting case of the t distribution of W. S. Gosset, also known as Student’s t distribution. Gosset’s t distribution plays a fundamental role in statistical inference.
- A chapter on the theory of wavelets, with some commentary on applications. This material occupies Chapter X, “Introduction to Wavelets.” Wavelets form another theory, beyond the frequency analysis of Fourier series and the Fourier transform, for decomposing functions of one or more variables into component parts that bring out hidden behavior of the functions. The theory was introduced in the 1980s and 1990s to bring together disparate applications in signal processing and related fields, and it has now reached a sufficient state of maturity that all mathematicians might benefit from some familiarity with

it. More information about the content of the chapter appears in the Guide to the Reader on pages xviii–xxii.

In addition, there were some minor changes to *Advanced Real Analysis*. First, Sections 1–4 of Chapter IX were revised and expanded to prepare for the Central Limit Theorem later in the chapter. Second, a third part was added to Problem 12 at the end of Chapter III to allow for an alternative approach to smoothness questions about wavelets. Third, a small number of minor corrections, fewer than a dozen, were made in the first eight chapters. And fourth, the References and Index were updated and expanded. No other changes were made to the body of the text.

As was true in the first edition, references in *Advanced Real Analysis* to the text of *Basic Real Analysis* abbreviate the title of the latter book as *Basic*.

Ann Kostant was the person who conceived the idea, about 2003, for Birkhäuser to have a series Cornerstones. Her vision was to enlist authors experienced at mathematical exposition who would write compatible texts at the early graduate level. The overall choice of topics was heavily influenced by the graduate curricula of major American universities. The idea was for each book in the series to explain what the young mathematician needs to know about a swath of mathematics in order to communicate well with colleagues in all branches of mathematics in the 21st century. Taken together, the books in the series were intended as an antidote for the worst effects of overspecialization. I am honored to have been part of her project.

It was Benjamin Levitt, Birkhäuser mathematics editor in New York as of 2014, who encouraged the writing of second editions of the real analysis books. He made a number of suggestions about pursuing them, and he passed along comments from several anonymous referees about the strengths and weaknesses of each book. I am especially grateful to those readers who have sent me comments over the years. The typesetting was done by the program Textures using *AMS-TEX*, and the figures were drawn with Mathematica.

As with the first editions, I invite corrections and other comments about the second editions from readers. For as long as I am able, I plan to point to lists of known corrections from my own Web page, www.math.stonybrook.edu/~aknapp.

A. W. KNAPP

August 2016

The corrected version issued in 2017 incorporates six small changes to Chapter III, one small change to Chapter IX, and approximately 80 small corrections to Chapter X. The ones for Chapter X were kindly pointed out by Esshan Khanmohammadi; one of them makes a correction to the formula in Theorem 10.10.

January 2017

PREFACE TO THE FIRST EDITION

This book and its companion volume *Basic Real Analysis* systematically develop concepts and tools in real analysis that are vital to every mathematician, whether pure or applied, aspiring or established. The two books together contain what the young mathematician needs to know about real analysis in order to communicate well with colleagues in all branches of mathematics.

The books are written as textbooks, and their primary audience is students who are learning the material for the first time and who are planning a career in which they will use advanced mathematics professionally. Much of the material in the books corresponds to normal course work. Nevertheless, it is often the case that core mathematics curricula, time-limited as they are, do not include all the topics that one might like. Thus the book includes important topics that are sometimes skipped in required courses but that the professional mathematician will ultimately want to learn by self-study.

The content of the required courses at each university reflects expectations of what students need before beginning specialized study and work on a thesis. These expectations vary from country to country and from university to university. Even so, there seems to be a rough consensus about what mathematics a plenary lecturer at a broad international or national meeting may take as known by the audience. The tables of contents of the two books represent my own understanding of what that degree of knowledge is for real analysis today.

Key topics and features of *Advanced Real Analysis* are that it:

- Develops Fourier analysis and functional analysis with an eye toward partial differential equations.
- Includes chapters on Sturm–Liouville theory, compact self-adjoint operators, Euclidean Fourier analysis, topological vector spaces and distributions, compact and locally compact groups, and aspects of partial differential equations.
- Contains chapters about analysis on manifolds and foundations of probability.
- Proceeds from the particular to the general, often introducing examples well before a theory that incorporates them.
- Includes many examples and almost 200 problems, and a separate section “Hints for Solutions of Problems” at the end of the book gives hints or complete solutions for most of the problems.

- Incorporates, both in the text and in the problems but particularly in the problems, material in which real analysis is used in algebra, in topology, in complex analysis, in probability, in differential geometry, and in applied mathematics of various kinds.

It is assumed that the reader has had courses in real variables and either is taking or has completed the kind of course in Lebesgue integration that might use *Basic Real Analysis* as a text. Knowledge of the content of most of Chapters I–VI and X of *Basic Real Analysis* is assumed throughout, and the need for further chapters of that book for particular topics is indicated in the chart on page xvii. When it is necessary in the text to quote a result from this material that might not be widely known, a specific reference to *Basic Real Analysis* is given; such references abbreviate the book title as *Basic*.

Some understanding of complex analysis is assumed for Sections 3–4 and 6 of Chapter III, for Sections 10–11 of Chapter IV, for Section 4 of Chapter V, for all of Chapters VII and VIII, and for certain groups of problems, but not otherwise. Familiarity with linear algebra and group theory at least at the undergraduate level is helpful throughout.

The topics in the first eight chapters of this volume are related to one another in many ways, and the book needed some definite organizational principle for its design. The result was a decision to organize topics largely according to their role in the study of differential equations, even if differential equations do not explicitly appear in each of the chapters. Much of the material has other uses as well, but an organization of topics with differential equations in mind provides a common focus for the mathematics that is presented. Thus, for example, Fourier analysis and functional analysis are subjects that stand on their own and also that draw on each other, but the writing of the chapters on these areas deliberately points toward the subject of differential equations, and toward tools like distributions that are used with differential equations. These matters all come together in two chapters on differential equations, Chapters VII and VIII, near the end of in the book.

Portions of the first eight chapters can be used as the text for a course in any of three ways. One way is as an introduction to differential equations within a course on Lebesgue integration that treats integration and the Fourier transform relatively lightly; the expectation in this case is that parts of at most two or three chapters of this book would be used. A second way is as a text for a self-contained topics course in differential equations; the book offers a great deal of flexibility for the content of such a course, and no single choice is right for everyone. A third way is simply as a text for a survey of some areas of advanced real analysis; again the book offers great flexibility in how such a course is constructed.

The problems at the ends of chapters are an important part of the book. Some

of them are really theorems, some are examples showing the degree to which hypotheses can be stretched, and a few are just exercises. The reader gets no indication which problems are of which type, nor of which ones are relatively easy. Each problem can be solved with tools developed up to that point in the book, plus any additional prerequisites that are noted.

This book seeks in part to help the reader look for and appreciate the unity of mathematics. For that reason some of the problems and sections go way outside the usual view of real analysis. One of the lessons about advanced mathematics is that progress is better measured by how mathematics brings together different threads, rather than how many new threads it generates.

Almost all of the mathematics in this book and *Basic Real Analysis* is at least forty years old, and I make no claim that any result is new. The two books are together a distillation of lecture notes from a 35-year period of my own learning and teaching. Sometimes a problem at the end of a chapter or an approach to the exposition may not be a standard one, but normally no attempt has been made to identify such problems and approaches.

I am grateful to Ann Kostant and Steven Krantz for encouraging this project and for making many suggestions about pursuing it, and to Susan Knapp and David Kramer for helping with the readability. The typesetting was by $A_M S$ - $T_E X$, and the figures were drawn with Mathematica.

I invite corrections and other comments from readers. I plan to maintain a list of known corrections on my own Web page.

A. W. KNAPP
June 2005

LIST OF FIGURES

1.1. Graphs of $\sin \pi p$ and $-p \cos \pi p$	10
3.1. Cone condition for a bounded open set	67
3.2. Calderón–Zygmund decomposition of \mathbb{R}^N	86
4.1. Extension of convex circled neighborhood of 0	136
7.1. Construction in the proof of the Hopf maximum principle	298
7.2. Support of the distribution kernel of an operator	314
9.1. Graph of the density of the normal distribution $N(0, 1)$	413
9.2. Approximate values of $\Phi(x) - \Phi(-x)$ for $N(0, 1)$	414
9.3. Normal distribution as a limit of Gosset’s t distribution	421
9.4. Table of approximate minimal values of c such that $\int_{-c}^c f_n(t) dt$ exceeds a threshold	422
10.1. Gibbs phenomenon for continuation of $f(x) = \frac{1}{2}(\pi - x)$	438
10.2. Graphs of Haar scaling function and wavelet	444
10.3. Graphs of Shannon scaling function and wavelet	466
10.4. Graph of Meyer polynomial function when $m = 3$	472
10.5. Polynomial $v(x)$ in definition of Meyer wavelet of index m	473
10.6. Graph of $\mathcal{F}\varphi$ for the Meyer wavelet when $m = 3$	473
10.7. Graph of $e^{-\pi iy} \mathcal{F}\psi$ for the Meyer wavelet when $m = 3$	474
10.8. Graphs of Meyer scaling function and wavelet when $m = 3$	476
10.9. Graph of the B -spline ${}^1\gamma$	478
10.10. Graph of Battle–Lemarié wavelet when $m = 1$	487
10.11. Graph of the B -spline ${}^2\gamma$	488
10.12. Graph of the B -spline ${}^3\gamma$	489
10.13. Values of $d_{2m}(y)$ for small m	494
10.14. Graph of Battle–Lemarié wavelet when $m = 2$	496
10.15. Graph of Battle–Lemarié wavelet when $m = 3$	496
10.16. Polynomials $P_N(w)$ used in defining Daubechies wavelets	502
10.17. Graphs of Daubechies wavelets for $N \leq 10$	513
10.18. Summary of properties of constructed wavelets	528

DEPENDENCE AMONG CHAPTERS

The chart below indicates the main lines of logical dependence of sections of *Advanced Real Analysis* on earlier sections and on chapters in *Basic Real Analysis*. Starting points are the boxes with double ruling. All starting points take Chapters I–VI and X of *Basic Real Analysis* as known. Uses of complex analysis as in Appendix B of *Basic Real Analysis* are indicated in the Guide for the Reader.

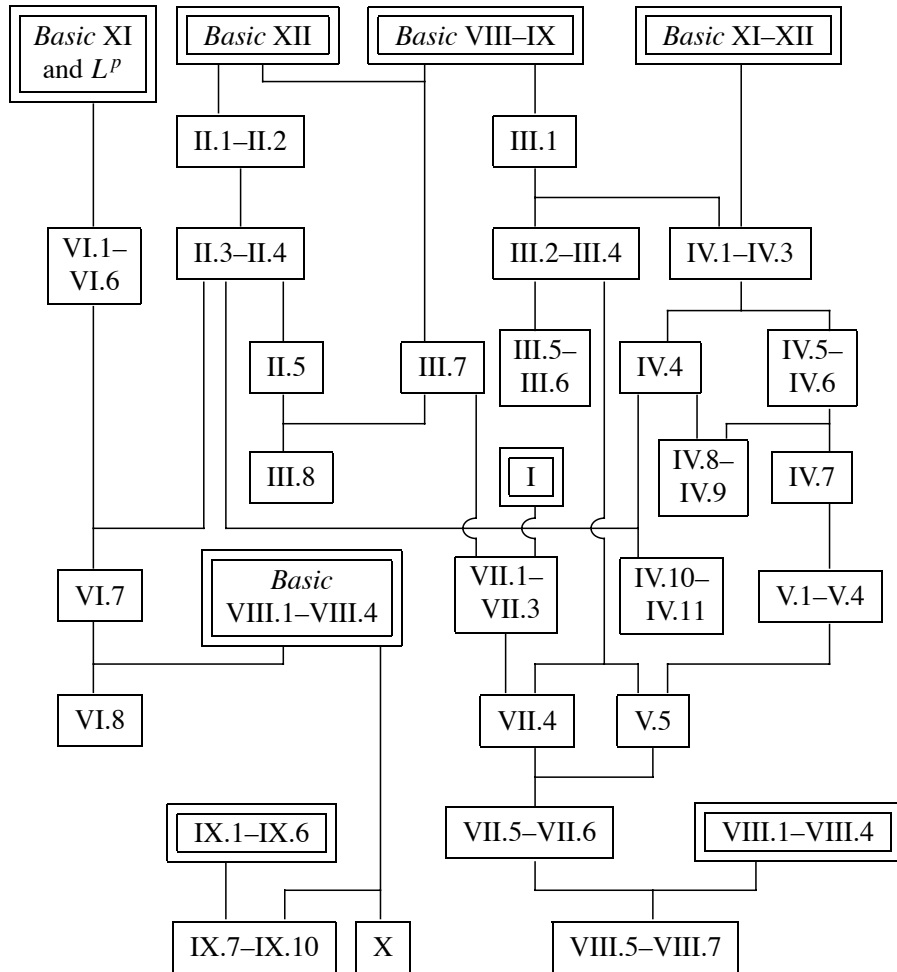

GUIDE FOR THE READER

This section is intended to help the reader find out what parts of each chapter are most important and how the chapters are interrelated. Further information of this kind is contained in the chart on page xvii and in the abstracts that begin each of the chapters.

Advanced Real Analysis deals with topics in real analysis that the young mathematician needs to know in order to communicate well with colleagues in all branches of mathematics. These topics include parts of Fourier analysis, functional analysis, spectral theory, distribution theory, abstract harmonic analysis, and partial differential equations. They tend to be ones whose applications and ramifications cut across several branches in mathematics. Each topic can be studied on its own, but the importance of the topic arises from its influence on the other topics and on other branches of mathematics. To avoid having all these relationships come across as a hopeless tangle, the book needed some organizational principle for its design. The principle chosen was largely to organize topics according to their role in the study of differential equations. This organizational principle influences what appears below, but it is certainly not intended to suggest that applications to differential equations are the only reason for studying certain topics in real analysis.

As was true also in *Basic Real Analysis*, several techniques that are used repeatedly in real analysis play a pivotal role. Examples are devices for justifying interchanges of limits, compactness and completeness as tools for proving existence theorems, and the approach of handling nice functions first and then passing to general functions. By the beginning of the present volume, these techniques have become sophisticated enough so as to account for entire areas of study within real analysis. The theory of weak derivatives illustrates this principle: The theory allows certain interchanges of limits involving weak derivatives to be carried out routinely, and the hard work occurs in translating the results into statements about classical derivatives. The main tool for this translation is Sobolev's Theorem, which in turn becomes the foundation for its own theory.

Each chapter is built around one or more important theorems. The commentary below tells the nature of each chapter and the role of some important theorems.

Chapter I marks two transitions—from concrete mathematics done by calculation to theorems established by functional analysis on the one hand, and from ordinary differential equations to partial differential equations on the other

hand. Section 2 about separation of variables is relatively elementary, introducing and illustrating a first technique for approaching partial differential equations. The technique involves a step of making calculations and a step of providing justification that the method is fully applicable. When the technique succeeds, the partial differential equation is reduced to two or more ordinary differential equations. Section 3 establishes, apart from one detail, the main theorem of the chapter, called Sturm's Theorem. Sturm's Theorem addresses the nature of solutions of certain kinds of ordinary differential equations with a parameter. This result can sometimes give a positive answer to the completeness questions needed to justify separation of variables, and it hints at a theory known as Sturm–Liouville theory that contains more results of this kind. The one detail with Sturm's Theorem that is postponed from Section 3 to Chapter II is the Hilbert–Schmidt Theorem.

Chapter II is a first chapter on functional analysis beyond Chapter XII of *Basic Real Analysis*, with emphasis on a simple case of the Spectral Theorem. The result in question describes the structure of compact self-adjoint operators on a Hilbert space. The Hilbert–Schmidt Theorem says that certain integral operators are of this kind, and it completes the proof of Sturm's Theorem as presented in Chapter I; however, Chapter I is not needed for an understanding of Chapter II. Section 4 of Chapter II gives several equivalent definitions of unitary operators and is relevant for many later chapters of the book. Section 5 discusses compact, Hilbert–Schmidt, and trace-class operators abstractly and may be skipped on first reading.

Chapter III is a first chapter on Fourier analysis beyond Chapters VIII and IX of *Basic Real Analysis*, and it discusses four topics that are somewhat independent of one another. The first of these, in Sections 1–2, introduces aspects of distribution theory and the idea of weak derivatives. The main result is Sobolev's Theorem, which tells how to extract conclusions about ordinary derivatives from conclusions about weak derivatives. Readers with a particular interest in this topic will want to study also Problems 8–12 and 25–34 at the end of the chapter. Sections 3–4 concern harmonic functions, which are functions annihilated by the Laplacian, and associated Poisson integrals, which relate harmonic functions to the subject of boundary-value problems. These sections may be viewed as providing an example of what to expect of the more general “elliptic” differential operators to be studied in Chapters VII–VIII. The main results are a mean value property for harmonic functions, a maximum principle, a reflection principle, and a characterization of harmonic functions in a half space that arise as Poisson integrals. Sections 5–6 establish the Calderón–Zygmund Theorem and give two applications to partial differential equations. The theorem generalizes the boundedness of the Hilbert transform, which was proved in Chapters VIII–IX of *Basic Real Analysis*. Historically the Calderón–Zygmund Theorem was a precursor to the theory of

pseudodifferential operators that is introduced in Chapter VII. Sections 7–8 gently introduce multiple Fourier series, which are used as a tool several times in later chapters. Chapter III makes connections with complex analysis in Sections 3–4 and 6, but complex analysis is needed only for examples and problems.

Chapter IV weaves together three lines of investigation in the area of functional analysis—one going toward spaces of smooth functions and distribution theory, another leading to fixed-point theorems, and a third leading to full-fledged spectral theory. The parts of the chapter relevant for spaces of smooth functions and distribution theory are Sections 1–2 and 5–7. This line of investigation continues in Chapters V and VII–VIII. The parts of the chapter relevant for fixed-point theorems are Sections 1, 3–6, and 8–9. Results of this kind, which have applications to equilibrium problems in economics and mathematical physics, are not pursued beyond Chapter IV in this book. The parts of the chapter relevant to spectral theory are Sections 1, 3–4, and 10–11, and spectral theory is not pursued beyond Chapter IV. Because the sections of the chapter have overlapping purposes, some of the main results play multiple roles. Among the main results are the characterization of finite-dimensional topological vector spaces as being Euclidean, the existence of “support” for distributions, Alaoglu’s Theorem asserting weak-star compactness of the closed unit ball of the dual of a Banach space, the Stone Representation Theorem as a model for the theory of commutative C^* algebras, a separation theorem concerning continuous linear functionals in locally convex topological vector spaces, the construction of inductive limit topologies, the Krein–Milman Theorem concerning the existence of extreme points, the structure theorem for commutative C^* algebras, and the Spectral Theorem for commuting families of bounded normal operators. Spectral theory has direct applications to differential equations beyond what appears in Chapters I–II, but the book does not go into these applications. Section 10 makes serious use of elementary complex analysis, and complex analysis is used implicitly in Section 11.

Chapter V develops the theory of distributions, and of operations on them, without going into their connection with Sobolev spaces. The chapter includes a lengthy discussion of convolution. The main results are a structure theorem for distributions of compact support in terms of derivatives of measures, a theorem saying that the Fourier transforms of such distributions are smooth functions, and a theorem saying that the convolution of a distribution of compact support and a tempered distribution is meaningful and tempered, with its Fourier transform being the product of the Fourier transforms. One theorem in Section 4 observes that the Fourier transform of a distribution of compact support is an entire function, but complex analysis otherwise plays no role in the chapter.

Chapter VI introduces harmonic analysis using groups. Section 1 concerns general topological groups, Sections 2–5 are about invariant measures on locally compact groups and their quotients, and Sections 6–7 concern the representation

theory of compact groups. Section 8 indicates how representation theory simplifies problems concerning linear operators with a sizable group of symmetries. One main result of the chapter is the existence and uniqueness of Haar measure, up to a scalar factor, on any locally compact group. Another is the Peter–Weyl Theorem, which is a completeness theorem for Fourier analysis on a general compact group akin to Parseval’s Theorem for Fourier series and the circle group. The proof of the Peter–Weyl Theorem uses the Hilbert–Schmidt Theorem.

Chapter VII is a first systematic discussion of partial differential equations, mostly linear, using tools from earlier chapters. Section 1 seeks to quantify the additional data needed for a differential equation or system simultaneously to have existence and uniqueness of solutions. The Cauchy–Kovalevskaya Theorem, which assumes that everything is holomorphic, is stated in general and gives a local result; for special kinds of systems it gives a global result whose proof is carried out in problems at the end of the chapter. Complex analysis of course plays a serious role in this section; it is used a little after Section 1, but its role thereafter is a minor one. Section 2 mentions some other properties and examples of differential equations, including the possibility of nonexistence of local solutions for linear equations $Lu = f$ when f is not holomorphic. Section 3 contains a general theorem asserting local existence of solutions for linear equations $Lu = f$ when L has constant coefficients; the proof uses multiple Fourier series. Section 5 concerns elliptic operators L with constant coefficients; these generalize the Laplacian. A complete proof is given in this case for the existence of a “parametrix” for L , which leads to control of regularity of solutions, and for the existence of “fundamental solutions.” Section 6 introduces, largely without proofs, a general theory of pseudodifferential operators. To focus attention on certain theorems, the section describes how the theory can be used to obtain parametrices for elliptic operators with variable coefficients.

Chapter VIII in Sections 1–4 introduces smooth manifolds and vector bundles over them, particularly the tangent and cotangent bundles. Readers who are already familiar with this material may want to skip these sections. Sections 5–8 use this material to extend the theory of differential and pseudodifferential operators to the setting of smooth manifolds, where such operators arise naturally in many applications. Section 7 in particular describes how to adapt the theory of Chapter VII to obtain parametrices for elliptic operators on smooth manifolds.

Chapter IX is a stand-alone chapter on probability theory. Although partial differential equations interact with probability theory and have applications to differential geometry and financial mathematics, such interactions are too advanced to be addressed in this book. Instead four matters are addressed that are foundational and yet at the level of this book: how measure theory is used to model real-world probabilistic situations, how the Kolmogorov Extension Theorem constructs measure spaces that underlie stochastic processes, how probabilistic

independence and a certain indifference to the nature of the underlying measure space lead to a proof of the Strong Law of Large Numbers, and how the measure-theoretic techniques of the book yield a proof of the Central Limit Theorem. The material on the Central Limit Theorem occupies about half of the chapter and makes extensive use results from *Basic Real Analysis* about the Fourier transform. A final section introduces the subject of statistical inference and makes use of complex analysis in one calculation. In the simplest case the subject of statistical inference seeks to deduce the mean and variance of a whole population from those of a small sample. The probabilities in question are captured by the t distribution of W. S. Gosset. The main theorem calculates the t distribution, and it is seen under suitable hypotheses that the t distribution tends to the normal distribution as the sample size tends to infinity.

Chapter X introduces wavelets. In the simplest case a wavelet is a function of one variable such that the dilations by powers of 2 of the integer translates of the function form an orthogonal basis of the space of square integrable functions. Square integrable functions may be regarded as signals to be used as input. Associated to any wavelet is an analysis of all signals that is quite different from Fourier analysis via frequencies. Namely for each resolution, i.e., for each power of 2 determining a dilation, the function is decomposed into one function giving a rough approximation and another function providing some detail. The exact decomposition depends on the original wavelet and is regarded by people who do signal processing as the result of passing the signal through two complementary filters. After the decomposition the function giving the rough approximation is processed at successively higher resolutions, while the function giving the detail is retained as a component of the given function. The result is that the given signal is decomposed into infinitely many functions giving details. In practice, the detail functions for all the coarsest resolutions are lumped into a single function, a first approximation to the given signal, and the components giving the higher-order detail may be regarded as improving on the first approximation. Chapter X studies a mechanism called a multiresolution analysis for carrying out this decomposition systematically. Several of the main theorems construct concrete wavelets and families of wavelets, progressively more sophisticated, that have been found useful in applications. The last section of the chapter addresses the question of using wavelet analysis to decompose functions in practice, and it provides commentary on a number of applications. Chapter X intermittently makes use of complex analysis, mostly by directly applying results in Appendix B of *Basic Real Analysis*. Beyond that, Sections 7 and 9 prove and apply two further theorems in complex analysis, namely a formula for the sum over integers n of $(z - n)^{-2}$ and the classical Paley–Wiener Theorem.

NOTATION AND TERMINOLOGY

This section lists notation and a few unusual terms from elementary mathematics and from *Basic Real Analysis* that are taken as standard in the text without further definition. The items are grouped by topic. Complex analysis is not included.

Set theory

\in	membership symbol
$\#S$ or $ S $	number of elements in S
\emptyset	empty set
$\{x \in E \mid P\}$	the set of x in E such that P holds
E^c	complement of the set E
$E \cup F, E \cap F, E - F$	union, intersection, difference of sets
$\bigcup_{\alpha} E_{\alpha}, \bigcap_{\alpha} E_{\alpha}$	union, intersection of the sets E_{α}
$E \subseteq F, E \supseteq F$	E is contained in F , E contains F
$E \times F, \prod_{s \in S} X_s$	products of sets
(a_1, \dots, a_n)	ordered n -tuple
$\{a_1, \dots, a_n\}$	unordered n -tuple
$f : E \rightarrow F, x \mapsto f(x)$	function, effect of function
$f \circ g, f _E$	composition of f following g , restriction to E
$f(\cdot, y)$	the function $x \mapsto f(x, y)$
$f(E), f^{-1}(E)$	direct and inverse image of a set
countable	finite or in one-one correspondence with integers
2^A	set of all subsets of A
B^A	set of all functions from B to A
card A	cardinality of A

Number systems

δ_{ij}	Kronecker delta: 1 if $i = j$, 0 if $i \neq j$
$\binom{n}{k}$	binomial coefficient
n positive, n negative	$n > 0, n < 0$
$\mathbb{Z}, \mathbb{Q}, \mathbb{R}, \mathbb{C}$	integers, rationals, reals, complex numbers
\mathbb{F}	\mathbb{R} or \mathbb{C} , the underlying field of scalars
max	maximum of finite subset of a totally ordered set
min	minimum of finite subset of a totally ordered set
\sum or \prod	sum or product, possibly with a limit operation

$[x]$	greatest integer $\leq x$ if x is real
$\operatorname{Re} z, \operatorname{Im} z$	real and imaginary parts of complex z
\bar{z}	complex conjugate of z
$ z $	absolute value of z

Linear algebra and elementary group theory

$\mathbb{R}^n, \mathbb{C}^n, \mathbb{F}^n$	spaces of column vectors with n entries
$x \cdot y$	dot product
e_j	j^{th} standard basis vector of \mathbb{R}^n
1 or I	identity matrix or operator
$\det A$	determinant of A
A^{tr}	transpose of A
$\operatorname{diag}(a_1, \dots, a_n)$	diagonal square matrix
$\operatorname{Tr} A$	trace of A
$[M_{ij}]$	matrix with $(i, j)^{\text{th}}$ entry M_{ij}
$\dim V$	dimension of vector space
0	additive identity in an abelian group
1	multiplicative identity in a group or ring
\cong	is isomorphic to, is equivalent to

Real-variable theory and calculus

\mathbb{R}^*	extended reals, reals with $\pm\infty$ adjoined
\sup and \inf	supremum and infimum in \mathbb{R}^*
$(a, b), [a, b]$	open interval in \mathbb{R}^* , closed interval
$(a, b], [a, b)$	half-open intervals in \mathbb{R}^*
\limsup_n, \liminf_n	$\inf_n \sup_{k \geq n}$ in \mathbb{R}^* , $\sup_n \inf_{k \geq n}$ in \mathbb{R}^*
\lim	limit in \mathbb{R} or \mathbb{R}^* or \mathbb{R}^N
$ x $	$(\sum_{j=1}^N x_j ^2)^{1/2}$ if $x = (x_1, \dots, x_N)$, scalars in \mathbb{R} or \mathbb{C}
e	$\sum_{n=0}^{\infty} 1/n!$
$\exp x, \sin x, \cos x, \tan x$	exponential and trigonometric functions
$\arcsin x, \arctan x$	inverse trigonometric functions
$\log x$	natural logarithm function on $(0, +\infty)$
$\frac{\partial f}{\partial x_j}$	partial derivative of f with respect to j^{th} variable
$C^k(V), k \geq 0$	scalar-valued functions on open set $V \subseteq \mathbb{R}^N$ with all partial derivatives continuous through order k , no assumption of boundedness
$C^\infty(V)$	$\bigcap_{k=0}^{\infty} C^k(V)$
$f : V \rightarrow \mathbb{F}$ is smooth	f is scalar valued and is in $C^\infty(V)$
homogeneous of degree d	satisfying $f(rx) = r^d f(x)$ for all $x \neq 0$ in \mathbb{R}^N and all $r > 0$ if f is a function $f : \mathbb{R}^N - \{0\} \rightarrow \mathbb{F}$

Metric spaces and topological spaces

d	typical name for a metric
$B(r; x)$	open ball of radius r and center x
A^{cl}	closure of A
A°	interior of A
separable	having a countable base for its open sets
$D(x, A)$	distance to a set A in a metric space
$x_n \rightarrow x$ or $\lim x_n = x$	limit relation for a sequence or a net
S^{N-1}	unit sphere in \mathbb{R}^N
support of function	closure of set where function is nonzero
$\ f\ _{\text{sup}}$	$\sup_{x \in S} f(x) $ if $f : X \rightarrow \mathbb{F}$ is given
$B(S)$	space of all <i>bounded</i> scalar-valued functions on S
$B(S, \mathbb{C})$ or $B(S, \mathbb{R})$	space of members of $B(S)$ with values in \mathbb{C} or \mathbb{R}
$C(S)$	space of all <i>bounded</i> scalar-valued continuous functions on S if S topological
$C(S, \mathbb{C})$ or $C(S, \mathbb{R})$	space of members of $C(S)$ with values in \mathbb{C} or \mathbb{R}
$C_{\text{com}}(S)$	space of functions in $C(S)$ with compact support
$C_0(S)$	space of functions in $C(S)$ vanishing at infinity if S is locally compact Hausdorff
X^*	one-point compactification of X

Measure theory

$m(E)$ or $ E $	Lebesgue measure of E
indicator function of set E	function equal to 1 on E , 0 off E
$I_E(x)$	indicator function of E at x
f^+	$\max(f, 0)$ for f with values in \mathbb{R}^*
f^-	$-\min(f, 0)$ for f with values in \mathbb{R}^*
$\int_E f d\mu$ or $\int_E f(x) d\mu(x)$	Lebesgue integral of f over E with respect to μ
dx	abbreviation for $d\mu(x)$ for μ =Lebesgue measure
$\int_a^b f dx$	Lebesgue integral of f on interval (a, b) with respect to Lebesgue measure
(X, \mathcal{A}, μ) or (X, μ)	typical measure space
a.e. $[d\mu]$	almost everywhere with respect to μ
$\nu = f d\mu$	complex measure ν with $\nu(E) = \int_E f d\mu$
$\mathcal{A} \times \mathcal{B}$	product of σ -algebras
$\mu \times \nu$	product of σ -finite measures
$\ f\ _p$	L^p norm, $1 \leq p \leq \infty$
p'	dual index to p with $p' = p/(p-1)$
$L^p(X, \mathcal{A}, \mu)$ or $L^p(X, \mu)$	space of functions with $\ f\ _p < \infty$ modulo functions equal to 0 a.e. $[d\mu]$

$f * g$	convolution
$f^*(x)$	Hardy–Littlewood maximal function, given by the supremum of the averages of $ f $ over balls centered at x
$d\omega$	spherical part of Lebesgue measure on \mathbb{R}^N , measure on S^{N-1} with $dx = r^{N-1} dr d\omega$
Ω_{N-1}	“area” of S^{N-1} given by $\Omega_{N-1} = \int_{S^{N-1}} d\omega$
$\Gamma(s)$	gamma function with $\Gamma(s) = \int_0^\infty t^{s-1} e^{-t} dt$
$\nu \ll \mu$	ν is absolutely continuous with respect to μ
Borel set in locally compact Hausdorff space X	set in σ -algebra generated by compact sets in X
$\mathcal{B}(X)$	σ -algebra of Borel sets if X is locally compact Hausdorff
compact G_δ	compact set equal to countable intersection of open sets
Baire set in locally compact Hausdorff space X	set in σ -algebra generated by compact G_δ 's in X
$M(X)$	space of all finite regular Borel complex measures on X if X is locally compact Hausdorff
$M(X, \mathbb{C})$ or $M(X, \mathbb{R})$	$M(X)$ with values in $\mathbb{F} = \mathbb{C}$ or $\mathbb{F} = \mathbb{R}$

Fourier series and Fourier transform

$c_n = \frac{1}{2\pi} \int_{-\pi}^{\pi} f(x) e^{-inx} dx$	Fourier coefficient
$f(x) \sim \sum_{n=-\infty}^{\infty} c_n e^{inx}$	Fourier series of f , with c_n as above
$s_N(f; x) = \sum_{n=-N}^N c_n e^{inx}$	partial sum of Fourier series
$\hat{f}(y) = \int_{\mathbb{R}^N} f(x) e^{-2\pi i x \cdot y} dx$	Fourier transform of an f in $L^1(\mathbb{R}^N)$
$f(x) = \int_{\mathbb{R}^N} \hat{f}(y) e^{2\pi i x \cdot y} dy$	Fourier inversion formula
\mathcal{F}	Fourier transform as an operator
$\ \mathcal{F}f\ _2 = \ f\ _2$	Plancherel formula
\mathcal{S} or $\mathcal{S}(\mathbb{R}^N)$	Schwartz space on \mathbb{R}^N
$\frac{1}{\pi} \lim_{\varepsilon \downarrow 0} \int_{ t \geq \varepsilon} \frac{f(x-t)}{t} dt$	Hilbert transform of function f on \mathbb{R}^1

Normed linear spaces and Banach spaces

$\ \cdot\ $	typical norm in a normed linear space
(\cdot, \cdot)	typical inner product in a Hilbert space,
	linear in first variable, conjugate linear in second
M^\perp	space of vectors orthogonal to all members of M
X^*	dual of normed linear space X
ι	canonical mapping of X into $X^{**} = (X^*)^*$
$\mathcal{B}(X, Y)$	space of bounded linear operators from X into Y

Advanced Real Analysis

CHAPTER I

Introduction to Boundary-Value Problems

Abstract. This chapter applies the theory of linear ordinary differential equations to certain boundary-value problems for partial differential equations.

Section 1 briefly introduces some notation and defines the three partial differential equations of principal interest—the heat equation, Laplace’s equation, and the wave equation.

Section 2 is a first exposure to solving partial differential equations, working with boundary-value problems for the three equations introduced in Section 1. The settings are ones where the method of “separation of variables” is successful. In each case the equation reduces to an ordinary differential equation in each independent variable, and some analysis is needed to see when the method actually solves a particular boundary-value problem. In simple cases Fourier series can be used. In more complicated cases Sturm’s Theorem, which is stated but not proved in this section, can be helpful.

Section 3 returns to Sturm’s Theorem, giving a proof contingent on the Hilbert–Schmidt Theorem, which itself is proved in Chapter II. The construction within this section finds a Green’s function for the second-order ordinary differential operator under study; the Green’s function defines an integral operator that is essentially an inverse to the second-order differential operator.

1. Partial Differential Operators

This chapter contains a first discussion of linear partial differential equations. The word “equation” almost always indicates that there is a single unknown function, and the word “partial” indicates that this function probably depends on more than one variable. In every case the equation will be **homogeneous** in the sense that it is an equality of terms, each of which is the product of the unknown function or one of its iterated partial derivatives to the first power, times a known coefficient function. Consequently the space of solutions on the domain set is a vector space, a fact that is sometimes called the **superposition principle**. The emphasis will be on a naive-sounding method of solution called “separation of variables” that works for some equations in some situations but not for all equations in all situations. This method, which will be described in Section 2, looks initially for solutions that are products of functions of one variable and hopes that all solutions can be constructed from these by taking linear combinations and passing to the limit.

For the basic existence-uniqueness results with ordinary differential equations, one studies single ordinary differential equations in the presence of initial data of the form $y(t_0) = y_0, \dots, y^{(n-1)}(t_0) = y_0^{(n-1)}$. Implicitly the independent variable is regarded as time. For the partial differential equations in the settings that we study in this section, the solutions are to be defined in a region of space for all time $t \geq 0$, and the corresponding additional data give information to be imposed on the solution function at the boundary of the resulting domain in space-time. Behavior at $t = 0$ will not be sufficient to determine solutions uniquely; we shall need further conditions that are to be satisfied for all $t \geq 0$ when the space variables are at the edge of the region of definition. We refer to these two types of conditions as **initial data** and **space-boundary data**. Together they are simply **boundary data** or **boundary values**.

For the most part the partial differential equations will be limited to three—the heat equation, the Laplace equation, and the wave equation. Each of these involves space variables in some \mathbb{R}^n , and the heat and wave equations involve also a time variable t . To simplify the notation, we shall indicate partial differentiations by subscripts; thus u_{xt} is shorthand for $\partial^2 u / \partial x \partial t$. The space variables are usually x_1, \dots, x_n , but we often write x, y, z for them if $n \leq 3$. The linear differential operator Δ given by

$$\Delta u = u_{x_1 x_1} + \dots + u_{x_n x_n}$$

is involved in the definition of all three equations and is known as the **Laplacian** in n space variables.

The first partial differential equation that we consider is the **heat equation**, which takes the form

$$u_t = \Delta u,$$

the unknown function $u(x_1, \dots, x_n, t)$ being real-valued in any physically meaningful situation. Heat flows by conduction, as a function of time, in the region of the space variables, and this equation governs the temperature on any open set where there are no external influences. It is usually assumed that external influences come into play on the boundary of the space region, rather than the interior. They do so through a given set of space-boundary data. Since time and distance squared have distinct physical units, some particular choice of units has been incorporated into the equation in order to make a certain constant reduce to 1.

The second partial differential equation that we consider is the **Laplace equation**, which takes the form

$$\Delta u = 0,$$

the unknown function $u(x_1, \dots, x_n)$ again being real-valued in any physically meaningful situation. A C^2 function that satisfies the Laplace equation on an open set is said to be **harmonic**. The potential due to an electrostatic charge is

harmonic on any open set where the charge is 0, and so are steady-state solutions of the heat equation, i.e., those solutions with time derivative 0.

The third and final partial differential equation that we consider is the **wave equation**, which takes the form

$$u_{tt} = \Delta u,$$

the unknown function $u(x_1, \dots, x_n)$ once again being real-valued in any physically meaningful situation. Waves of light or sound spread in some medium in space as a function of time. In our applications we consider only cases in which the number of space variables is 1 or 2, and the function u is interpreted as the displacement as a function of the space and time variables.

2. Separation of Variables

We shall describe the method of separation of variables largely through what happens in examples. As we shall see, the rigorous verification that separation of variables is successful in a particular example makes serious analytic demands that bring together a great deal of real-variable theory as discussed in Chapters I–IV of *Basic*.¹ The general method of separation of variables allows use of a definite integral of multiples of the basic product solutions, but we shall limit ourselves to situations in which a sum or an infinite series of multiples of basic product solutions is sufficient. Roughly speaking, there are four steps:

- (i) Search for basic solutions that are the products of one-variable functions, and form sums or infinite series of multiples of them (or integrals in a more general setting).
- (ii) Use the boundary data to determine what specific multiples of the basic product solutions are to be used.
- (iii) Address completeness of the expansions as far as dealing with all sets of boundary data is concerned.
- (iv) Justify that the obtained solution has the required properties.

Steps (i) and (ii) are just a matter of formal computation, but steps (iii) and (iv) often require serious analysis. In step (iii) the expression “all sets of boundary data” needs some explanation, as far as smoothness conditions are concerned. The normal assumption for the three partial differential equations of interest is that the data have two continuous derivatives, just as the solutions of the equations are to have. Often one can verify (iii) and carry out (iv) for somewhat rougher

¹Throughout this book the word “*Basic*” indicates the companion volume *Basic Real Analysis*.

data, but the verification of (iv) in this case may be regarded as an analysis problem separate from solving the partial differential equation.

The condition that the basic product solutions in (i) form a discrete set, so that the hoped-for solutions are given by infinite series and not integrals, normally results from assuming that the space variables are restricted to a bounded set and that sufficiently many boundary conditions are specified. In really simple situations the benefit that we obtain is that an analytic problem potentially involving Fourier integrals is replaced by a more elementary analytic problem with Fourier series; in more complicated situations we obtain a comparable benefit. Step (iii) is crucial since it partially addresses the question whether the solution we seek is at all related to basic product solutions. Let us come back to what step (iii) entails in a moment. Step (iv) is a matter of interchanges of limits. One step consists in showing that the expected solution satisfies the partial differential equation, and this amounts to interchanging infinite sums with derivatives. It often comes down to the standard theorem in real-variable theory for that kind of interchange, which is proved in the real-valued case as Theorem 1.23 of *Basic* and extended to the vector-valued case later. We restate it here in the vector-valued case for handy reference.

Theorem 1.1. Suppose that $\{f_n\}$ is a sequence of functions on an interval with values in a finite-dimensional real or complex vector space V . Suppose further that the functions are continuous for $a \leq t \leq b$ and differentiable for $a < t < b$, that $\{f'_n\}$ converges uniformly for $a < t < b$, and that $\{f_n(x_0)\}$ converges in V for some x_0 with $a \leq x_0 \leq b$. Then $\{f_n\}$ converges uniformly for $a \leq t \leq b$ to a function f , and $f'(x) = \lim_n f'_n(x)$ for $a < x < b$, with the derivative and the limit existing.

Another step in handling (iv) consists in showing that the expected solution has the asserted boundary values. This amounts to interchanging infinite sums with passages to the limit as certain variables tend to the boundary, and the following result can often handle that.

Proposition 1.2. Let X be a set, let Y be a metric space, let $A_n(x)$ be a sequence of complex-valued functions on X such that $\sum_{n=1}^{\infty} |A_n(x)|$ converges uniformly, and let $B_n(y)$ be a sequence of complex-valued functions on Y such that $|B_n(y)| \leq 1$ for all n and y and such that $\lim_{y \rightarrow y_0} B_n(y) = B_n(y_0)$ for all n . Then

$$\lim_{y \rightarrow y_0} \sum_{n=1}^{\infty} A_n(x) B_n(y) = \sum_{n=1}^{\infty} A_n(x) B_n(y_0),$$

and the convergence is uniform in x if, in addition to the above hypotheses, each $A_n(x)$ is bounded.

PROOF. Let $\epsilon > 0$ be given, and choose N large enough so that $\sum_{n=N+1}^{\infty} |A_n(x)|$ is $< \epsilon$. Then

$$\begin{aligned} \left| \sum_{n=1}^{\infty} A_n(x) B_n(y) - \sum_{n=1}^{\infty} A_n(x) B_n(y_0) \right| &= \left| \sum_{n=1}^{\infty} A_n(x) (B_n(y) - B_n(y_0)) \right| \\ &\leq \sum_{n=1}^N |A_n(x)| |B_n(y) - B_n(y_0)| + 2 \sum_{n=N+1}^{\infty} |A_n(x)| \\ &< 2\epsilon + \sum_{n=1}^N |A_n(x)| |B_n(y) - B_n(y_0)|. \end{aligned}$$

For y close enough to y_0 , the second term on the right side is $< \epsilon$, and the pointwise limit relation is proved. The above argument shows that the convergence is uniform in x if $\max_{1 \leq n \leq N} |A_n(x)| \leq M$ independently of x . \square

In combination with a problem² in *Basic*, Proposition 1.2 shows, under the hypotheses as stated, that if X is a metric space and if $\sum_{n=1}^{\infty} A_n(x) B_n(y)$ is continuous on $X \times (Y - \{y_0\})$, then it is continuous on $X \times Y$. This conclusion can be regarded, for our purposes, as tying the solution of the partial differential equation well enough to one of its boundary conditions. It is in this sense that Proposition 1.2 contributes to handling part of step (iv).

Let us return to step (iii). Sometimes this step is handled by the completeness of Fourier series as expressed through a uniqueness theorem³ or Parseval's Theorem.⁴ But these methods work in only a few examples. The tools necessary to deal completely with step (iii) in all discrete cases generate a sizable area of analysis known in part as "Sturm–Liouville theory," of which Fourier series is only the beginning. We do not propose developing all these tools, but we shall give in Theorem 1.3 one such tool that goes beyond ordinary Fourier series, deferring any discussion of its proof to the next section.

For functions defined on intervals, the behavior of the functions at the endpoints will be relevant to us: we say that a continuous function $f : [a, b] \rightarrow \mathbb{C}$ with a derivative on (a, b) has a continuous derivative at one or both endpoints if f' has a finite limit at the endpoint in question; it is equivalent to say that f extends to a larger set so as to be differentiable in an open interval about the endpoint and to have its derivative be continuous at the endpoint.

Theorem 1.3 (Sturm's Theorem). Let p , q , and r be continuous real-valued functions on $[a, b]$ such that p' and r'' exist and are continuous and such that p

²Problem 6 at the end of Chapter II.

³Corollaries 1.60 and 1.66 in *Basic*.

⁴Theorem 1.61 in *Basic*.

and r are everywhere positive for $a \leq t \leq b$. Let c_1, c_2, d_1, d_2 be real numbers such that c_1 and c_2 are not both 0 and d_1 and d_2 are not both 0. Finally for each complex number λ , let (SL) be the following set of conditions on a function $u : [a, b] \rightarrow \mathbb{C}$ with two continuous derivatives:

$$(p(t)u')' - q(t)u + \lambda r(t)u = 0, \quad (\text{SL1})$$

$$c_1u(a) + c_2u'(a) = 0 \quad \text{and} \quad d_1u(b) + d_2u'(b) = 0. \quad (\text{SL2})$$

Then the system (SL) has a nonzero solution for a countably infinite set of values of λ . If E denotes this set of values, then the members λ of E are all real, they have no limit point in \mathbb{R} , and the vector space of solutions of (SL) is 1-dimensional for each such λ . The set E is bounded below if $c_1c_2 \leq 0$ and $d_1d_2 \geq 0$, and E is bounded below by 0 if these conditions and the condition $q \geq 0$ are all satisfied. In any case, enumerate E as $\lambda_1, \lambda_2, \dots$, let $u = \varphi_n$ be a nonzero solution of (SL) when $\lambda = \lambda_n$, define $(f, g)_r = \int_a^b f(t)\overline{g(t)}r(t) dt$ and $\|f\|_r = \left(\int_a^b |f(t)|^2 r(t) dt\right)^{1/2}$ for continuous f and g , and normalize φ_n so that $\|\varphi_n\|_r = 1$. Then $(\varphi_n, \varphi_m)_r = 0$ for $m \neq n$, and the functions φ_n satisfy the following completeness conditions:

- (a) any u having two continuous derivatives on $[a, b]$ and satisfying (SL2) has the property that the series $\sum_{n=1}^{\infty} (u, \varphi_n)_r \varphi_n(t)$ converges absolutely uniformly to $u(t)$ on $[a, b]$,
- (b) the only continuous φ on $[a, b]$ with $(\varphi, \varphi_n)_r = 0$ for all n is $\varphi = 0$,
- (c) any continuous φ on $[a, b]$ satisfies $\|\varphi\|_r^2 = \sum_{n=1}^{\infty} |(\varphi, \varphi_n)_r|^2$.

REMARK. The expression **converges absolutely uniformly** in (a) means that $\sum_{n=1}^{\infty} |(u, \varphi_n)_r \varphi_n(t)|$ converges uniformly.

EXAMPLE. The prototype for Theorem 1.3 is the constant-coefficient case $p = r = 1$ and $q = 0$. The equation (SL1) is just $u'' + \lambda u = 0$. If λ happens to be > 0 , then the solutions are $u(t) = C_1 \cos pt + C_2 \sin pt$, where $\lambda = p^2$. Suppose $[a, b] = [0, \pi]$. The condition $c_1u(0) + c_2u'(0) = 0$ says that $c_1C_1 + pc_2C_2 = 0$ and forces a linear relationship between C_1 and C_2 that depends on p . The condition $d_1u(\pi) + d_2u'(\pi) = 0$ gives a further such relationship. These two conditions may or may not be compatible. An especially simple special case is that $c_2 = d_2 = 0$, so that (SL2) requires $u(0) = u(\pi) = 0$. From $u(0) = 0$, we get $C_1 = 0$, and then $u(\pi) = 0$ forces $\sin p\pi = 0$ if u is to be a nonzero solution. Thus p must be an integer. It may be checked that $\lambda \leq 0$ leads to no nonzero solutions if $c_2 = d_2 = 0$. Part (a) of the theorem therefore says that any twice continuously differentiable function $u(t)$ on $[0, \pi]$ vanishing at 0 and π has an expansion $u(t) = \sum_{p=1}^{\infty} b_p \sin pt$, the series being absolutely uniformly convergent.

The first partial differential equation that we consider is the **heat equation** $u_t = \Delta u$, and we are interested in real-valued solutions.

EXAMPLES WITH THE HEAT EQUATION.

(1) We suppose that there is a single space variable x and that the set in 1-dimensional space is a rod $0 \leq x \leq l$. The unknown function is $u(x, t)$, and the boundary data are

$$\begin{aligned} u(x, 0) &= f(x) && \text{(initial temperature equal to } f(x)\text{),} \\ u(0, t) = u(l, t) &= 0 && \text{(ends of rod at absolute 0 temperature for all } t \geq 0\text{).} \end{aligned}$$

Heat flows in the rod for $t \geq 0$, and we want to know what happens. The equation for the heat flow is $u_t = u_{xx}$, and we search for solutions of the form $u(x, t) = X(x)T(t)$. Unless $T(t)$ is identically 0, the boundary data force $X(x)T(0) = f(x)$ and $X(0) = X(l) = 0$. Substitution into the heat equation gives

$$X(x)T'(t) = X''(x)T(t).$$

We divide by $X(x)T(t)$ and obtain

$$\frac{T'(t)}{T(t)} = \frac{X''(x)}{X(x)}.$$

A function of t alone can equal a function of x alone only if it is constant, and thus

$$\frac{T'(t)}{T(t)} = \frac{X''(x)}{X(x)} = c$$

for some real constant c . The bound variable is x , and we hope that the possible values of c lie in a discrete set. Suppose that c is > 0 , so that $c = p^2$ with $p > 0$. The equation $X''(x)/X(x) = p^2$ would say that $X(x) = c_1 e^{px} + c_2 e^{-px}$. From $X(0) = 0$, we get $c_2 = -c_1$, so that $X(x) = c_1(e^{px} - e^{-px})$. Since $e^{px} - e^{-px}$ is strictly increasing, $c_1(e^{px} - e^{-px}) = 0$ is impossible unless $c_1 = 0$. Thus we must have $c \leq 0$. Similarly $c = 0$ is impossible, and the conclusion is that $c < 0$. We write $c = -p^2$ with $p > 0$. The equation is $X''(x) = -p^2 X(x)$, and then $X(x) = c_1 \cos px + c_2 \sin px$. The condition $X(0) = 0$ says $c_1 = 0$, and the condition $X(l) = 0$ then says that $p = n\pi/l$ for some integer n . Thus

$$X(x) = \sin(n\pi x/l),$$

up to a multiplicative constant. The t equation becomes $T'(t) = -p^2 T = -(n\pi/l)^2 T(t)$, and hence

$$T(t) = e^{-(n\pi/l)^2 t},$$

up to a multiplicative constant. Our product solution is then a multiple of $e^{-(n\pi/l)^2 t} \sin(n\pi x/l)$, and the form of solution we expect for the boundary-value problem is therefore

$$u(x, t) = \sum_{n=1}^{\infty} c_n e^{-(n\pi/l)^2 t} \sin(n\pi x/l).$$

The constants c_n are determined by the condition at $t = 0$. We extend $f(x)$, which is initially defined for $0 \leq x \leq l$, to be defined for $-l \leq x \leq l$ and to be an odd function. The constants c_n are then the Fourier coefficients of f except that the period is $2l$ rather than 2π :

$$f(x) \sim \sum_{n=1}^{\infty} c_n \sin \frac{n\pi x}{l} \quad \text{with } c_n = \frac{1}{l} \int_{-l}^l f(y) \sin \frac{n\pi y}{l} dy = \frac{2}{l} \int_0^l f(y) \sin \frac{n\pi y}{l} dy.$$

Normally the Fourier series would have cosine terms as well as sine terms, but the cosine terms all have coefficient 0 since f is odd. In any event, we now have an explicit infinite series that we hope gives the desired solution $u(x, t)$. Checking that the function $u(x, t)$ defined above is indeed the desired solution amounts to handling steps (iii) and (iv) in the method of separation of variables. For (iii), we want to know whether $f(x)$ really can be represented in the indicated form. This example is simple enough that (iii) can be handled by the theory of Fourier series as in Chapter I of *Basic*: since f is assumed to have two continuous derivatives on $[0, l]$, the Fourier series converges uniformly by the Weierstrass M test, and the sum must be f by the uniqueness theorem. Another way of handling (iii) is to apply Theorem 1.3 to the equation $y'' + \lambda y = 0$ subject to the conditions $y(0) = 0$ and $y(l) = 0$: The theorem gives us a certain unique abstract expansion without giving us formulas for the explicit functions that are involved. It says also that we have completeness and absolute uniform convergence. Since our explicit expansion with sines satisfies the requirements of the unique abstract expansion, it must agree with the abstract expansion and it must converge absolutely uniformly. Whichever approach we use, the result is that we have now handled (iii). Step (iv) in the method is the justification that $u(x, t)$ has all the required properties: we have to check that the function in question solves the heat equation and takes on the asserted boundary values. The function in question satisfies the heat equation because of Theorem 1.1 and the rapid convergence of the series $\sum_{n=1}^{\infty} e^{-(n\pi/l)^2 t}$ and its first and second derivatives. The question about boundary values is completely settled by Proposition 1.2. For the condition $u(x, 0) = f(x)$, we take $X = [0, l]$, $Y = [0, +\infty)$, $y = t$, $A_n(x) = c_n \sin(n\pi x/l)$, $B_n(t) = e^{-(n\pi/l)^2 t}$, and $y_0 = 0$ in the proposition; uniform convergence of $\sum |A_n(x)|$ follows either from Theorem 1.3 or from the

Fourier-series estimate $|c_n| \leq C/n^2$, which in turn follows from the assumption that f has two continuous derivatives. The conditions $u(0, t) = u(l, t) = 0$ may be verified in the same way by reversing the roles of the space variable and the time variable. To check that $u(0, t) = 0$, for example, we use Proposition 1.2 with $X = (\delta, +\infty)$, $Y = [0, l]$, and $y_0 = 0$. Our boundary-value problem is therefore now completely solved.

(2) We continue to assume that space is 1-dimensional and that the object of interest is a rod $0 \leq x \leq l$. The unknown function for heat flow in the rod is still $u(x, t)$, but this time the boundary data are

$$\begin{aligned} u(x, 0) &= f(x) && \text{(initial temperature equal to } f(x)\text{),} \\ u_x(0, t) &= u_x(l, t) = 0 && \text{(ends of rod perfectly insulated for all } t \geq 0\text{).} \end{aligned}$$

In the same way as in Example 1, a product solution $X(x)T(t)$ leads to a separated equation $T'(t)/T(t) = X''(x)/X(x)$, and both sides must be some constant $-\lambda$. The equation for $X(x)$ is then

$$X'' + \lambda X = 0 \quad \text{with } X'(0) = X'(l) = 0.$$

We find that λ has to be of the form p^2 with $p = n\pi/l$ for some integer $n \geq 0$, and $X(x)$ has to be a multiple of $\cos(n\pi x/l)$. Taking into account the formula $\lambda = p^2$, we see that the equation for $T(t)$ is

$$T'(t) = -p^2 T(t).$$

Then $T(t)$ has to be a multiple of $e^{-(n\pi/l)^2 t}$, and our product solution is a multiple of $e^{-(n\pi/l)^2 t} \cos(n\pi x/l)$. The form of solution we expect for the boundary-value problem is therefore

$$u(x, t) = \sum_{n=0}^{\infty} c_n e^{-(n\pi/l)^2 t} \cos(n\pi x/l).$$

We determine the coefficients c_n by using the initial condition $u(x, 0) = f(x)$, and thus we want to represent $f(x)$ by a series of cosines:

$$f(x) \sim \sum_{n=0}^{\infty} c_n \cos \frac{n\pi x}{l}.$$

We can do so by extending $f(x)$ from $[0, l]$ to $[-l, l]$ so as to be even and using ordinary Fourier coefficients. The formula is therefore $c_n = \frac{2}{l} \int_0^l f(y) \cos \frac{n\pi y}{l} dy$ for $n > 0$, with $c_0 = \frac{1}{l} \int_0^l f(y) dy$. Again as in Example 1, we can carry out step (iii) of the method either by using the theory of Fourier series or by appealing to Theorem 1.3. In step (iv), we can again use Theorem 1.1 to see that the prospective function $u(x, t)$ satisfies the heat equation, and the boundary-value conditions can be checked with the aid of Proposition 1.2.

(3) We still assume that space is 1-dimensional and that the object of interest is a rod $0 \leq x \leq l$. The unknown function for heat flow in the rod is still $u(x, t)$, but this time the boundary data are

$$\begin{aligned} u(x, 0) &= f(x) && \text{(initial temperature equal to } f(x)\text{),} \\ u(0, t) &= 0 && \text{(one end of rod held at temperature 0),} \\ u_x(l, t) &= -hu(l, t) && \text{(other end radiating into a medium of temperature 0),} \end{aligned}$$

and h is assumed positive. In the same way as in Example 1, a product solution $X(x)T(t)$ leads to a separated equation $T'(t)/T(t) = X''(x)/X(x)$, and both sides must be some constant $-\lambda$. The equation for $X(x)$ is then

$$X'' + \lambda X = 0 \quad \text{with} \quad \begin{cases} X(0) = 0, \\ hX(l) + X'(l) = 0. \end{cases}$$

From the equation $X'' + \lambda X = 0$ and the condition $X(0) = 0$, $X(x)$ has to be a multiple of $\sinh px$ with $\lambda = -p^2 < 0$, or of x with $\lambda = 0$, or of $\sin px$ with $\lambda = p^2 > 0$. In the first two cases, $hX(l) + X'(l)$ equals $h \sinh pl + p \cosh pl$ or $hl + 1$ and cannot be 0. Thus we must have $\lambda = p^2 > 0$, and $X(x)$ is a multiple of $\sin px$. The condition $hX(l) + X'(l) = 0$ then holds if and only if $h \sin pl + p \cos pl = 0$. This equation has infinitely many positive solutions p , and we write them as p_1, p_2, \dots . See Figure 1.1 for what happens when $l = \pi$.

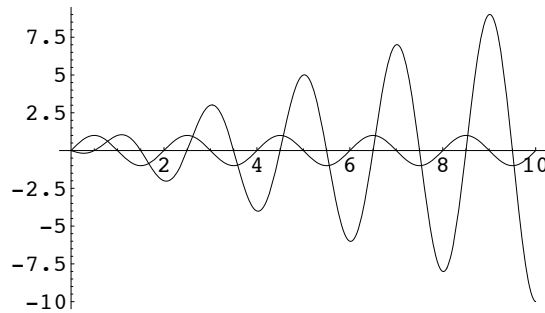

FIGURE 1.1. Graphs of $\sin \pi p$ and $-p \cos \pi p$. The graphs intersect for infinitely many values of $\pm p$.

If $\lambda = p_n^2$, then the equation for $T(t)$ is $T'(t) = -p_n^2 T(t)$, and $T(t)$ has to be a multiple of $e^{-p_n^2 t}$. Thus our product solution is a multiple of $e^{-p_n^2 t} \sin p_n x$, and the form of solution we expect for the boundary-value problem is

$$u(x, t) = \sum_{n=1}^{\infty} c_n e^{-p_n^2 t} \sin p_n x.$$

Putting $t = 0$, we see that we want to choose constants c_n such that

$$f(x) \sim \sum_{n=1}^{\infty} c_n \sin p_n x.$$

There is no reason why the numbers p_n should form an arithmetic progression, and such an expansion is not a result in the subject of Fourier series. To handle step (iii), this time we appeal to Theorem 1.3. That theorem points out the remarkable fact that the functions $\sin p_n x$ satisfy the orthogonality property $\int_0^l \sin p_n x \sin p_m x dx = 0$ if $n \neq m$ and therefore that

$$c_n = \int_0^l f(y) \sin p_n y dy \bigg/ \int_0^l \sin^2 p_n y dy .$$

Even more remarkably, the theorem gives us a completeness result and a convergence result. Thus (iii) is completely finished. In step (iv), we use Theorem 1.1 to check that $u(x, t)$ satisfies the partial differential equation, just as in Examples 1 and 2. The same technique as in Examples 1 and 2 with Proposition 1.2 works to recover the boundary value $u(x, 0)$ as a limit; this time we use Theorem 1.3 for the absolute uniform convergence in the x variable. For $u(0, t)$, one new comment is appropriate: we take $X = (\delta, +\infty)$, $Y = [0, l]$, $y_0 = 0$, $A_n(x) = e^{-p_n^2 t}$, and $B_n(y) = c_n \sin p_n x$; although the estimate $|B_n(y)| \leq 1$ may not be valid for all n , it is valid for n sufficiently large because of the uniform convergence of $\sum c_n \sin p_n x$.

4) This time we assume that space is 2-dimensional and that the object of interest is a circular plate. The unknown function for heat flow in the plate is $u(x, y, t)$, the differential equation is $u_t = u_{xx} + u_{yy}$, and the assumptions about boundary data are that the temperature distribution is known on the plate at $t = 0$ and that the edge of the plate is held at temperature 0 for all $t \geq 0$. Let us use polar coordinates (r, θ) in the (x, y) plane, let us assume that the plate is described by $r \leq 1$, and let us write the unknown function as $v(r, \theta, t) = u(r \cos \theta, r \sin \theta, t)$. The heat equation becomes

$$v_t = v_{rr} + r^{-1} v_r + r^{-2} v_{\theta\theta},$$

and the boundary data are given by

$$\begin{aligned} v(r, \theta, 0) &= f(r, \theta) && \text{(initial temperature equal to } f(r, \theta)), \\ v(1, \theta, t) &= 0 && \text{(edge of plate held at temperature 0).} \end{aligned}$$

We first look for solutions of the heat equation of the form $R(r)\Theta(\theta)T(t)$. Substitution and division by $R(r)\Theta(\theta)T(t)$ gives

$$\frac{R''(r)}{R(r)} + \frac{1}{r} \frac{R'(r)}{R(r)} + \frac{1}{r^2} \frac{\Theta''(\theta)}{\Theta(\theta)} = \frac{T'(t)}{T(t)} = -c,$$

so that $T(t)$ is a multiple of e^{-ct} . The equation relating R , Θ , and c becomes

$$\frac{r^2 R''(r)}{R(r)} + \frac{r R'(r)}{R(r)} + \frac{\Theta''(\theta)}{\Theta(\theta)} = -cr^2.$$

Therefore

$$\frac{\Theta''(\theta)}{\Theta(\theta)} = -\lambda = -\frac{r^2 R''(r)}{R(r)} - \frac{r R'(r)}{R(r)} - cr^2.$$

Since $\Theta(\theta)$ has to be periodic of period 2π , we must have $\lambda = n^2$ with n an integer ≥ 0 ; then $\Theta(\theta) = c_1 \cos n\theta + c_2 \sin n\theta$. The equation for $R(r)$ becomes

$$r^2 R'' + r R' + (cr^2 - n^2)R = 0.$$

This has a regular singular point at $r = 0$, and the indicial equation is $s^2 = n^2$. Thus $s = \pm n$. In fact, we can recognize this equation as Bessel's equation of order n by a change of variables: A little argument excludes $c \leq 0$. Putting $k = \sqrt{c}$, $\rho = kr$, and $y(\rho) = R(r)$ leads to $y'' + \rho^{-1}y' + (1 - n^2\rho^{-2})y = 0$, which is exactly Bessel's equation of order n . Transforming the solution $y(\rho) = J_n(\rho)$ back with $r = k^{-1}\rho$, we see that $R(r) = y(\rho) = J_n(\rho) = J_n(kr)$ is a solution of the equation for R . A basic product solution is therefore $\frac{1}{2}a_{0,k}J_0(kr)$ if $n = 0$ or

$$J_n(kr)(a_{n,k} \cos n\theta + b_{n,k} \sin n\theta)e^{-k^2 t}$$

if $n > 0$. The index n has to be an integer in order for v to be well behaved at the center, or origin, of the plate, but we have not thus far restricted k to a discrete set. However, the condition of temperature 0 at $r = 1$ means that $J_n(k)$ has to be 0, and the zeros of J_n form a discrete set. The given condition at $t = 0$ means that we want

$$f(r, \theta) \sim \frac{1}{2} \sum_{\substack{k>0 \text{ with} \\ J_0(kr)=0}} a_{0,k} J_0(kr) + \sum_{n=1}^{\infty} \left(\sum_{\substack{k>0 \text{ with} \\ J_n(kr)=0}} (a_{n,k} \cos n\theta + b_{n,k} \sin n\theta) J_n(kr) \right).$$

We do not have the tools to establish this kind of relation, but we can see a hint of what to do. The orthogonality conditions that allow us to write candidates for the coefficients are the usual orthogonality for trigonometric functions and the relation

$$\int_0^1 J_n(kr) J_n(k'r) r dr = 0 \quad \text{if } J_n(k) = J_n(k') = 0 \text{ and } k \neq k'.$$

The latter is not quite a consequence of Theorem 1.3, but it is close since the equation satisfied by $y_k(r) = J_n(kr)$, namely

$$(r y_k')' + (k^2 r - n^2 r^{-1}) y_k = r y_k'' + y_k' + (k^2 r - n^2 r^{-1}) y_k = 0,$$

fails to be of the form in Theorem 1.3 only because of trouble at the endpoint $r = 0$ of the domain interval. In fact, the argument in the next section for the orthogonality in Theorem 1.3 will work also in this case; see Problem 2 at the end of the chapter. Thus put

$$a_n(r) = \frac{1}{\pi} \int_{-\pi}^{\pi} f(r, \theta) \cos n\theta \, d\theta \quad \text{and} \quad b_n(r) = \frac{1}{\pi} \int_{-\pi}^{\pi} f(r, \theta) \sin n\theta \, d\theta,$$

so that

$$f(r, \theta) \sim \frac{1}{2}a_0(r) + \sum_{n=1}^{\infty} (a_n(r) \cos n\theta + b_n(r) \sin n\theta) \quad \text{for each } r.$$

Then put
$$a_{n,k} = \int_0^1 a_n(r) y_k(r) r \, dr \bigg/ \int_0^1 y_k(r)^2 r \, dr$$

and
$$b_{n,k} = \int_0^1 b_n(r) y_k(r) r \, dr \bigg/ \int_0^1 y_k(r)^2 r \, dr .$$

With these values in place, handling step (iii) amounts to showing that

$$f(r, \theta) = \frac{1}{2} \sum_{\substack{k>0 \text{ with} \\ J_0(kr)=0}} a_{0,k} J_0(kr) + \sum_{n=1}^{\infty} \left(\sum_{\substack{k>0 \text{ with} \\ J_n(kr)=0}} (a_{n,k} \cos n\theta + b_{n,k} \sin n\theta) J_n(kr) \right)$$

for functions f of class C^2 . This formula is valid, but we would need a result from Sturm–Liouville theory that is different from Theorem 1.3 in order to prove it. Step (iv) is to use the convergence from Sturm–Liouville theory, together with application of Proposition 1.2 and Theorem 1.1, to see that the function $u(r, \theta, t)$ given by

$$\frac{1}{2} \sum_{\substack{k>0 \text{ with} \\ J_0(kr)=0}} a_{0,k} J_0(kr) e^{-k^2 t} + \sum_{n=1}^{\infty} \left(\sum_{\substack{k>0 \text{ with} \\ J_n(kr)=0}} (a_{n,k} \cos n\theta + b_{n,k} \sin n\theta) J_n(kr) e^{-k^2 t} \right)$$

has all the required properties.

The second partial differential equation that we consider is the **Laplace equation** $\Delta u = 0$. Various sets of boundary data can be given, but we deal only with the values of u on the edge of its bounded domain of definition. In this case the problem of finding u is known as the **Dirichlet problem**.

EXAMPLES WITH LAPLACE EQUATION.

(1) We suppose that the space domain is the unit disk in \mathbb{R}^2 . The Laplace equation in polar coordinates (r, θ) is $u_{rr} + r^{-1}u_r + r^{-2}u_{\theta\theta} = 0$. The unknown function is $u(r, \theta)$, and the given boundary values of u for the Dirichlet problem are

$$u(1, \theta) = f(\theta) \quad (\text{value on unit circle}).$$

It is implicit that $u(r, \theta)$ is to be periodic of period 2π in θ and is to be well behaved at $r = 0$. A product solution is of the form $R(r)\Theta(\theta)$. We substitute into the equation, divide by $r^{-2}R(r)\Theta(\theta)$, and find that the variables separate as

$$\frac{r^2 R''}{R} + \frac{r R'}{R} = -\frac{\Theta''}{\Theta} = c.$$

The equation for Θ is $\Theta'' + c\Theta = 0$, and the solution is required to be periodic. We might be tempted to try to apply Theorem 1.3 at this stage, but the boundary condition of periodicity, $\Theta(-\pi) = \Theta(\pi)$, is not exactly of the right kind for Theorem 1.3. Fortunately we can handle matters directly, using Fourier series in the analysis. The periodicity forces $c = n^2$ with n an integer ≥ 0 . Then $\Theta(\theta) = c_1 \cos n\theta + c_2 \sin n\theta$, except that the sine term is not needed when $n = 0$. The equation for R becomes

$$r^2 R'' + r R' - n^2 R = 0.$$

This is an Euler equation with indicial equation $s^2 = n^2$, and hence $s = \pm n$. We discard $-n$ with $n \geq 1$ because the solution r^{-n} is not well behaved at $r = 0$, and we discard also the second solution $\log r$ that goes with $n = 0$. Consequently $R(r)$ is a multiple of r^n , and the product solution is $r^n(a_n \cos n\theta + b_n \sin n\theta)$ when $n > 0$. The expected solution of the Laplace equation is then

$$u(r, \theta) = \frac{1}{2}a_0 + \sum_{n=1}^{\infty} r^n (a_n \cos n\theta + b_n \sin n\theta).$$

We determine a_n and b_n by formally putting $r = 1$, and we see that a_n and b_n are to be the ordinary Fourier coefficients of $f(x)$. The normal assumption for a boundary-value problem is that f is as nice a function as u and hence has two continuous derivatives. In this case we know that the Fourier series converges to $f(x)$ uniformly. It is immediate from Theorem 1.1 that $u(r, \theta)$ satisfies Laplace's equation for $r < 1$, and Proposition 1.2 shows that $u(r, \theta)$ has the desired boundary values. This completes the solution of the boundary-value problem. In this example the solution $u(r, \theta)$ is given by a nice integral formula: The same easy computation that expresses the partial sums of a Fourier series in

terms of the Dirichlet kernel allows us to write $u(r, \theta)$ in terms of the **Poisson kernel**

$$P_r(\theta) = \frac{1 - r^2}{1 - 2r \cos \theta + r^2} = \sum_{n=-\infty}^{\infty} r^{|n|} e^{in\theta},$$

namely

$$\begin{aligned} u(r, \theta) &= \sum_{n=-\infty}^{\infty} r^{|n|} \left(\frac{1}{2\pi} \int_{-\pi}^{\pi} f(\varphi) e^{-in\varphi} d\varphi \right) e^{in\theta} \\ &= \frac{1}{2\pi} \int_{-\pi}^{\pi} f(\varphi) \left(\sum_{n=-\infty}^{\infty} r^{|n|} e^{in(\theta-\varphi)} \right) d\varphi \\ &= \frac{1}{2\pi} \int_{-\pi}^{\pi} f(\varphi) P_r(\theta - \varphi) d\varphi \\ &= \frac{1}{2\pi} \int_{-\pi}^{\pi} f(\theta - \varphi) P_r(\varphi) d\varphi. \end{aligned}$$

The interchange of integral and sum for the second equality is valid because of the uniform convergence of the series $\sum_{n=-\infty}^{\infty} r^{|n|} e^{in(\theta-\varphi)}$ for fixed r . The resulting formula for $u(r, \theta)$ is known as the **Poisson integral formula** for the unit disk.

(2) We suppose that the space domain is the unit ball in \mathbb{R}^3 . The Laplace equation in spherical coordinates (r, φ, θ) , with φ measuring latitude from the point $(x, y, z) = (0, 0, 1)$, is

$$(r^2 u_r)_r + \frac{1}{\sin \varphi} ((\sin \varphi) u_\varphi)_\varphi + \frac{1}{\sin^2 \varphi} u_{\theta\theta} = 0.$$

The unknown function is $u(r, \varphi, \theta)$, and the given boundary values of u for the Dirichlet problem are

$$u(1, \varphi, \theta) = f(\varphi, \theta) \quad (\text{value on unit sphere}).$$

The function u is to be periodic in θ and is to be well behaved at $r = 0$, $\varphi = 0$, and $\varphi = \pi$. Searching for a solution $R(r)\Phi(\varphi)\Theta(\theta)$ leads to the separated equation

$$\frac{r^2 R'' + 2r R'}{R} = -\frac{\Phi'' + (\cot \varphi)\Phi'}{\Phi} - \frac{1}{\sin^2 \varphi} \frac{\Theta''}{\Theta} = c.$$

The resulting equation for R is $r^2 R'' + 2r R' - cR = 0$, which is an Euler equation whose indicial equation has roots s satisfying $s(s+1) = c$. The condition that a solution of the Laplace equation be well behaved at $r = 0$ means that the solution

r^s must have s equal to an integer $m \geq 0$. Then $R(r)$ is a multiple of r^m with m an integer ≥ 0 and with $c = m(m+1)$. The equation involving Φ and Θ is then

$$(\sin^2 \varphi) \frac{\Phi'' + (\cot \varphi)\Phi'}{\Phi} + \frac{\Theta''}{\Theta} + m(m+1) \sin^2 \varphi = 0.$$

This equation shows that $\Theta''/\Theta = c'$, and as usual we obtain $c' = -n^2$ with n an integer ≥ 0 . Then $\Theta(\theta) = c_1 \cos n\theta + c_2 \sin n\theta$. Substituting into the equation for Φ yields

$$(\sin^2 \varphi) \frac{\Phi'' + (\cot \varphi)\Phi'}{\Phi} - n^2 + m(m+1) \sin^2 \varphi = 0.$$

We make the change of variables $t = \cos \varphi$, which has

$$\frac{d}{d\varphi} = -\sin \varphi \frac{d}{dt} \quad \text{and} \quad \frac{d^2}{d\varphi^2} = -(\cos \varphi) \frac{d}{dt} + (\sin^2 \varphi) \frac{d^2}{dt^2}.$$

Putting $P(t) = P(\cos \varphi) = \Phi(\varphi)$ for $0 \leq \varphi \leq \pi$ leads to

$$(1-t^2) \left[\frac{(1-t^2)P'' - tP' + (\cot \varphi)(-\sin \varphi)P'}{P} \right] - n^2 + m(m+1)(1-t^2) = 0$$

and then to

$$(1-t^2)P'' - 2tP' + \left[m(m+1) - \frac{n^2}{1-t^2} \right] P = 0.$$

This is known as an **associated Legendre equation**. For $n = 0$, which is the case of a solution independent of longitude θ , the equation reduces to the ordinary Legendre equation.⁵ Suppose for simplicity that f is independent of longitude θ and that we can take $n = 0$ in this equation. One solution of the equation for P is $P(t) = P_m(t)$, the m^{th} Legendre polynomial. This is well behaved at $t = \pm 1$, the values of t that correspond to $\varphi = 0$ and $\varphi = \pi$. Making a change of variables, we can see that the Legendre equation has regular singular points at $t = 1$ and $t = -1$. By examining the indicial equations at these points, we can see that there is only a 1-parameter family of solutions of the equation for P that are well behaved at $t = \pm 1$. Thus $\Phi(\varphi)$ has to be a multiple of $P_m(\cos \varphi)$, and we are led to expect

$$u(r, \varphi, \theta) = \sum_{m=0}^{\infty} c_m r^m P_m(\cos \varphi)$$

⁵The ordinary Legendre equation is $(1-t^2)P'' - 2tP' + m(m+1)P = 0$, as in Section IV.8 of *Basic*.

for solutions that are independent of θ . If $f(\varphi, \theta)$ is independent of θ , we determine c_m by the formula

$$f(\varphi, \theta) \sim \sum_{m=0}^{\infty} c_m P_m(\cos \varphi).$$

The coefficients can be determined because the polynomials P_m are orthogonal under integration over $[-1, 1]$. To see this fact, we first rewrite the equation for P as $((1-t^2)P')' + m(m+1)P = 0$. This is almost of the form in Theorem 1.3, but the coefficient $1-t^2$ vanishes at the endpoints $t = \pm 1$. Although the orthogonality does not then follow from Theorem 1.3, it may be proved in the same way as the orthogonality that is part of Theorem 1.3; see Problem 2 at the end of the chapter. A part of the completeness question is easily settled by observing that P_m is of degree m and that therefore the linear span of $\{P_0, P_1, \dots, P_N\}$ is the same as the linear span of $\{1, t, \dots, t^N\}$. This much does not establish, however, that the series $\sum c_m P_m(t)$ converges uniformly. For that, we would need yet another result from Sturm–Liouville theory or elsewhere. Once the uniform convergence has been established, step (iv) can be handled in the usual way.

The third and final partial differential equation that we consider is the **wave equation** $u_{tt} = \Delta u$. We consider examples of boundary-value problems in one and two space variables.

EXAMPLES WITH WAVE EQUATION.

(1) A string on the x axis under tension is such that each point can be displaced only in the y direction. Let $y = u(x, t)$ be the displacement. The equation for the unknown function $u(x, t)$ in suitable physical units is $u_{tt} = u_{xx}$, and the boundary data are

$$\begin{aligned} u(x, 0) &= f(x) && \text{(initial displacement),} \\ u_t(x, 0) &= g(x) && \text{(initial velocity),} \\ u(0, t) = u(l, t) &= 0 && \text{(ends of string fixed for all } t \geq 0\text{).} \end{aligned}$$

The string vibrates for $t \geq 0$, and we want to know what happens. Searching for basic product solutions $X(x)T(t)$, we are led to $T''/T = X''/X = \text{constant}$. As usual the conditions at $x = 0$ and $x = l$ force the constant to be nonpositive, necessarily $-\omega^2$ with $\omega \geq 0$. Then $X(x) = c_1 \cos \omega x + c_2 \sin \omega x$. We obtain $c_1 = 0$ from $X(0) = 0$, and we obtain $\omega = n\pi/l$, with n an integer, from $X(l) = 0$. Thus $X(x)$ has to be a multiple of $\sin(n\pi x/l)$, and we may take $n > 0$. Examining the T equation, we are readily led to expect

$$u(x, t) = \sum_{n=1}^{\infty} \sin(n\pi x/l) [a_n \cos(n\pi t/l) + b_n \sin(n\pi t/l)].$$

The conditions $u(x, 0) = f(x)$ and $u_t(x, 0)$ say that

$$f(x) \sim \sum_{n=1}^{\infty} a_n \sin\left(\frac{n\pi x}{l}\right) \quad \text{and} \quad g(x) \sim \sum_{n=1}^{\infty} \left(\frac{n\pi}{l}\right) b_n \sin\left(\frac{n\pi x}{l}\right),$$

so that a_n and $n\pi b_n/l$ are coefficients in the Fourier sine series for f and g . Steps (iii) and (iv) in the method follow in the same way as in earlier examples.

(2) We visualize a vibrating circular drum. A membrane in the (x, y) plane covers the unit disk and is under uniform tension. Each point can be displaced only in the z direction. Let $u(x, y, t) = U(r, \theta, t)$ be the displacement. The wave equation $u_{tt} = u_{xx} + u_{yy}$ becomes $U_{tt} = U_{rr} + r^{-1}U_r + r^{-2}U_{\theta\theta}$ in polar coordinates. Assume for simplicity that the boundary data are

$$\begin{aligned} U(r, \theta, 0) &= f(r) && \text{(initial displacement independent of } \theta), \\ U_t(r, \theta, 0) &= 0 && \text{(initial velocity 0),} \\ U(1, \theta, t) &= 0 && \text{(edge of drum fixed for all } t \geq 0). \end{aligned}$$

Because of the radial symmetry, let us look for basic product solutions of the form $R(r)T(t)$. Substituting and separating variables, we are led to $T''/T = (R'' + r^{-1}R')/R = c$. The equation for R is $r^2R'' + rR' - cr^2R = 0$, and the usual considerations do not determine the sign of c . The equation for R has a regular singular point at $r = 0$, but it is not an Euler equation. The indicial equation is $s^2 = 0$, with $s = 0$ as a root of multiplicity 2, independently of c . One solution is given by a power series in r , while another involves $\log r$. We discard the solution with the logarithm because it would represent a singularity at the middle of the drum. To get at the sign of c , we use the condition $R(1) = 0$ and argue as follows: Without loss of generality, $R(0)$ is positive. Suppose $c > 0$, and let $r_1 \leq 1$ be the first value of $r > 0$ where $R(r_1) = 0$. From the equation $r^{-1}(rR')' = cR$ and the inequality $R(r) > 0$ for $0 < r < r_1$, we see that rR' is strictly increasing for $0 < r < r_1$. Examining the power series expansion for $R(r)$, we see that $R'(0) = 0$. Thus $R'(r) > 0$ for $0 < r < r_1$. But $R(0) > 0$ and $R(r_1) = 0$ imply, by the Mean Value Theorem, that $R'(r)$ is < 0 somewhere in between, and we have a contradiction. Similarly we rule out $c = 0$. We conclude that c is negative, i.e., $c = -k^2$ with $k > 0$. The equation for R is then

$$r^2R'' + rR' + k^2r^2R = 0.$$

The change of variables $\rho = kr$ reduces this equation to Bessel's equation of order 0, and the upshot is that $R(r)$ is a multiple of $J_0(kr)$. The condition $R(1) = 0$ means that $J_0(k) = 0$. If k_n is the n^{th} positive zero of J_0 , then the T equation is

$T'' + k_n^2 T = 0$, so that $T(t) = c_1 \cos k_n t + c_2 \sin k_n t$. From $U_t(r, \theta, 0) = 0$, we obtain $c_2 = 0$. Thus $T(t)$ is a multiple of $\cos k_n t$, and we expect that

$$U(r, \theta, t) = \sum_{n=1}^{\infty} c_n J_0(k_n r) \cos k_n t.$$

In step (iii), the determination of the c_n 's and the necessary analysis are similar to those in Example 4 for the heat equation, and it is not necessary to repeat them. Step (iv) is handled in much the same way as in the vibrating-string problem.

3. Sturm–Liouville Theory

The name “Sturm–Liouville theory” refers to the analysis of certain kinds of “eigenvalue” problems for linear ordinary differential equations, particularly equations of the second order. In this section we shall concentrate on one theorem of this kind, which was stated explicitly in Section 2 and was used as a tool for verifying that the method of separation of variables succeeded, for some examples, in solving a boundary-value problem for one of the standard partial differential equations. Before taking up this one theorem, however, let us make some general remarks about the setting, about “eigenvalues” and “eigenfunctions,” and about “self-adjointness.”

Fix attention on an interval $[a, b]$ and on second-order differential operators on this interval of the form $L = P(t)D^2 + Q(t)D + R(t)1$ with $D = d/dt$, so that

$$L(u) = P(t)u'' + Q(t)u' + R(t)u.$$

We shall assume that the coefficient functions P , Q , and R are real-valued; then $L(\bar{u}) = \overline{L(u)}$. As was mentioned in Section 2, the behavior of all functions in question at the endpoints will be relevant to us: we say that a continuous function $f : [a, b] \rightarrow \mathbb{C}$ with a derivative on (a, b) has a continuous derivative at one or both endpoints if f' has a finite limit at the endpoint in question; it is equivalent to say that f extends to a larger set so as to be differentiable in an open interval about the endpoint and to have its derivative be continuous at the endpoint.

An **eigenvalue** of the differential operator L is a complex number c such that $L(u) = cu$ for some nonzero function u . Such a function u is called an **eigenfunction**. In practice we often have a particular nonvanishing function r and look for c such $L(u) = cru$ for a nonzero u . In this case, c is an eigenvalue of $r^{-1}L$.

We introduce the inner-product space of complex-valued functions with two continuous derivatives on $[a, b]$ and with $(u, v) = \int_a^b u(t)\overline{v(t)} dt$. Computation

using integration by parts and assuming suitable differentiability of the coefficients gives

$$\begin{aligned}
(L(u), v) &= \int_a^b (Pu'' + Qu' + Ru)\bar{v} dt \\
&= \int_a^b ((u'')(P\bar{v}) + (u')(Q\bar{v}) + (u)(R\bar{v})) dt \\
&= \left[(u')(P\bar{v}) + (u)(Q\bar{v}) \right]_a^b - \int_a^b (u'(P\bar{v})' + (u)(Q\bar{v})' - (u)(R\bar{v})) dt \\
&= \left[(u')(P\bar{v}) + (u)(Q\bar{v}) - (u)(P\bar{v})' \right]_a^b \\
&\quad + \int_a^b ((u)(P\bar{v})'' - (u)(Q\bar{v})' + (u)(R\bar{v})) dt \\
&= (u, L^*(v)) + \left[(u')(P\bar{v}) + (u)(Q\bar{v}) - u(P\bar{v})' \right]_a^b,
\end{aligned}$$

where $L^*(v) = Pv'' + (2P' - Q)v' + (P'' - Q' + R)v$. The above computation shows that $(L(u), v) = (u, L^*(v))$ if the integrated terms are ignored; this property is the abstract defining property of L^* . The differential operator L^* is called the **formal adjoint** of L . We shall be interested only in the situation in which $L^* = L$, which we readily see happens if and only if $P' = Q$; when $L^* = L$, we say that L is **formally self adjoint**. If L is formally self adjoint, then substitution of $Q = P'$ shows that the above identity reduces to

$$(L(u), v) - (u, L(v)) = \left[(P)(u'\bar{v} - u\bar{v}') \right]_a^b,$$

which is known as **Green's formula**.

Even when L as above is not formally self adjoint, it can be multiplied by a nonvanishing function, specifically $\int^t \exp[(Q(s) - P'(s))/P(s)] ds$, to become formally self adjoint. Thus formal self-adjointness by itself is no restriction on our second-order differential operator.

In the formally self-adjoint case, one often rewrites $P(t)D^2 + P'(t)D$ as $D(P(t)D)$. With this understanding, let us rewrite our operator as

$$L(u) = (p(t)u')' - q(t)u$$

and assume that p , p' , and q are continuous on $[a, b]$ and that $p(t) > 0$ for $a \leq t \leq b$. We associate a **Sturm-Liouville eigenvalue problem** called (SL) to the set of data consisting of L , an everywhere-positive function r with two continuous derivatives on $[a, b]$, and real numbers c_1, c_2, d_1, d_2 such that c_1 and c_2 are not both 0 and d_1 and d_2 are not both 0. This is the problem of analyzing simultaneous solutions of

$$L(u) + \lambda r(t)u = 0, \quad (\text{SL1})$$

$$c_1 u(a) + c_2 u'(a) = 0 \quad \text{and} \quad d_1 u(b) + d_2 u'(b) = 0, \quad (\text{SL2})$$

for all values of λ .

Each condition (SL1) and (SL2) depends linearly on u and u' if λ is fixed, and thus the space of solutions of (SL) for fixed λ is a vector space. We know⁶ that the vector space of solutions of (SL1) alone is 2-dimensional; let u_1 and u_2 form a basis of this vector space. The Wronskian matrix is $\begin{pmatrix} u_1(t) & u_2(t) \\ u_1'(t) & u_2'(t) \end{pmatrix}$, and the determinant of this matrix, namely

$$u_1(t)u_2'(t) - u_1'(t)u_2(t),$$

is nowhere 0. If u_1 and u_2 were both to satisfy the condition $c_1 u(a) + c_2 u'(a) = 0$ with c_1 and c_2 not both 0, then $\begin{pmatrix} c_1 \\ c_2 \end{pmatrix}$ would be a nontrivial solution of the matrix equation

$$\begin{pmatrix} u_1(a) & u_1'(a) \\ u_2(a) & u_2'(a) \end{pmatrix} \begin{pmatrix} c_1 \\ c_2 \end{pmatrix} = \begin{pmatrix} 0 \\ 0 \end{pmatrix}$$

and we would obtain the contradictory conclusion that the Wronskian matrix at a is singular. We conclude that the space of solutions of (SL) for fixed λ is at most 1-dimensional.

Let $(\varphi_1, \varphi_2)_r = \int_a^b \varphi_1(t) \overline{\varphi_2(t)} r(t) dt$ for any continuous functions φ_1 and φ_2 on $[a, b]$, and let $\|\varphi_1\|_r = ((\varphi_1, \varphi_1)_r)^{1/2}$. The unsubscripted expressions (φ_1, φ_2) and $\|\varphi_1\|$ will refer to $(\varphi_1, \varphi_2)_r$ and $\|\varphi_1\|_r$ with $r = 1$. Then we can restate Theorem 1.3 as follows.

Theorem 1.3' (Sturm's Theorem). The system (SL) has a nonzero solution for a countably infinite set of values of λ . If E denotes this set of values, then the members λ of E are all real, they have no limit point in \mathbb{R} , and the space of solutions of (SL) is 1-dimensional for each such λ . The set E is bounded below if $c_1 c_2 \leq 0$ and $d_1 d_2 \geq 0$, and E is bounded below by 0 if these conditions and the condition $q \geq 0$ are all satisfied. In any case, enumerate E in any fashion as $\lambda_1, \lambda_2, \dots$, let $u = \varphi_n$ be a nonzero solution of (SL) when $\lambda = \lambda_n$, and normalize φ_n so that $\|\varphi_n\|_r = 1$. Then $(\varphi_n, \varphi_m)_r = 0$ for $m \neq n$, and the functions φ_n satisfy the following completeness conditions:

- (a) any u having two continuous derivatives on $[a, b]$ and satisfying (SL2) has the property that the series $\sum_{n=1}^{\infty} (u, \varphi_n)_r \varphi_n(t)$ converges absolutely uniformly to $u(t)$ on $[a, b]$,
- (b) the only continuous φ on $[a, b]$ with $(\varphi, \varphi_n)_r = 0$ for all n is $\varphi = 0$,
- (c) any continuous φ on $[a, b]$ satisfies $\|\varphi\|_r^2 = \sum_{n=1}^{\infty} |(\varphi, \varphi_n)_r|^2$.

⁶From Theorem 4.6 of *Basic*, for example.

REMARKS. In this section we shall reduce the proof of everything but (b) and (c) to the Hilbert–Schmidt Theorem, which will be proved in Chapter II. Conclusions (b) and (c) follow from (a) and some elementary facts about Hilbert spaces, and we shall return to prove these two conclusions at the time of the Hilbert–Schmidt Theorem in Chapter II.

PROOF EXCEPT FOR STEPS TO BE COMPLETED IN CHAPTER II. By way of preliminaries, let u and v be nonzero functions on $[a, b]$ satisfying (SL2) and having two continuous derivatives. Green's formula gives

$$\begin{aligned} (L(u), v) - (u, L(v)) &= [(p)(u'\bar{v} - u\bar{v}')]_a^b \\ &= p(b)(u'(b)\bar{v}(b) - u(b)\bar{v}'(b)) - p(a)(u'(a)\bar{v}(a) - u(a)\bar{v}'(a)). \end{aligned}$$

Condition (SL2) says that

$$c_1u(a) + c_2u'(a) = 0 \quad \text{and} \quad c_1v(a) + c_2v'(a) = 0.$$

Since c_1 and c_2 are real, these equations yield

$$c_1u(a)\bar{v}(a) + c_2u'(a)\bar{v}(a) = 0 \quad \text{and} \quad c_1u(a)\bar{v}'(a) + c_2u'(a)\bar{v}'(a) = 0,$$

as well as

$$c_1u(a)\bar{v}'(a) + c_2u'(a)\bar{v}'(a) = 0 \quad \text{and} \quad c_1u'(a)\bar{v}(a) + c_2u'(a)\bar{v}'(a) = 0.$$

Subtracting, for each of the above two displays, each second equation of a display from the first equation of the display, we obtain

$$c_2(u'(a)\bar{v}(a) - u(a)\bar{v}'(a)) = 0$$

and

$$c_1(u(a)\bar{v}'(a) - u'(a)\bar{v}(a)) = 0.$$

Since c_1 and c_2 are not both 0, we conclude that $p(a)(u'(a)\bar{v}(a) - u(a)\bar{v}'(a)) = 0$. A similar computation starting from

$$d_1u(b) + d_2u'(b) = 0 \quad \text{and} \quad d_1v(b) + d_2v'(b) = 0$$

shows that $p(b)(u'(b)\bar{v}(b) - u(b)\bar{v}'(b)) = 0$. Consequently

$$(L(u), v) - (u, L(v)) = 0$$

whenever u and v are functions on $[a, b]$ satisfying (SL2) and having two continuous derivatives.

Now we can begin to establish the properties of the set E of numbers λ for which (SL) has a nonzero solution. Suppose that φ_α and φ_β satisfy $L(\varphi_\alpha) + \lambda_\alpha r \varphi_\alpha = 0$ and $L(\varphi_\beta) + \lambda_\beta r \varphi_\beta = 0$. By what we have just seen,

$$\begin{aligned} 0 &= (L(\varphi_\alpha), \varphi_\beta) - (\varphi_\alpha, L(\varphi_\beta)) \\ &= \int_a^b L(\varphi_\alpha) \bar{\varphi}_\beta dt - \int_a^b \varphi_\alpha \overline{L(\varphi_\beta)} dt \\ &= (-\lambda_\alpha + \bar{\lambda}_\beta) \int_a^b \varphi_\alpha \bar{\varphi}_\beta r dt = (-\lambda_\alpha + \bar{\lambda}_\beta) (\varphi_\alpha, \varphi_\beta)_r. \end{aligned}$$

Taking $\varphi_\alpha = \varphi_\beta$ in this computation shows that $\lambda_\alpha = \bar{\lambda}_\alpha$; hence λ_α is real. With λ_α and λ_β real and unequal, this computation shows that $(\varphi_\alpha, \varphi_\beta)_r = 0$. Thus the members of E are real, and the corresponding φ 's are orthogonal. We have seen that the dimension of the space of solutions of (SL) corresponding to any member of E is 1-dimensional.

We shall prove that E is at most countably infinite. Let $c = \left(\int_a^b r(t) dt\right)^{1/2}$. Any continuous φ on $[a, b]$ satisfies

$$\|\varphi\|_r = \left(\int_a^b |\varphi(t)|^2 r(t) dt\right)^{1/2} \leq \left(\sup_{a \leq t \leq b} |\varphi(t)|\right) \left(\int_a^b r(t) dt\right)^{1/2} = c \sup |\varphi|.$$

Consider the open ball $B(k; \varphi)$ of radius k and center φ in the space $C([a, b])$ of continuous functions on $[a, b]$; the metric is given by the supremum of the absolute value of the difference of the functions. If ψ is in this ball, then $\sup |\psi - \varphi| < k$, $c \sup |\psi - \varphi| < ck$, and $\|\psi - \varphi\|_r < ck$. Choose k with $ck = \frac{1}{2}$. Suppose that φ_α and φ_β correspond as above to unequal λ_α and λ_β and that φ_α and φ_β have been normalized so that $\|\varphi_\alpha\|_r = \|\varphi_\beta\|_r = 1$. If ψ is in $B(k; \varphi_\alpha) \cap B(k; \varphi_\beta)$, then $\|\psi - \varphi_\alpha\|_r < \frac{1}{2}$ and $\|\psi - \varphi_\beta\|_r < \frac{1}{2}$. The triangle inequality gives $\|\varphi_\alpha - \varphi_\beta\|_r < 1$, whereas the orthogonality implies that

$$\begin{aligned} \|\varphi_\alpha - \varphi_\beta\|_r^2 &= (\varphi_\alpha - \varphi_\beta, \varphi_\alpha - \varphi_\beta)_r \\ &= (\varphi_\alpha, \varphi_\alpha)_r - (\varphi_\alpha, \varphi_\beta)_r - (\varphi_\beta, \varphi_\alpha)_r + (\varphi_\beta, \varphi_\beta)_r \\ &= 1 - 0 - 0 + 1 = 2. \end{aligned}$$

The existence of ψ thus leads us to a contradiction, and we conclude that $B(k; \varphi_\alpha)$ and $B(k; \varphi_\beta)$ are disjoint. Since $[a, b]$ is a compact metric space, $C([a, b])$ is separable as a metric space,⁷ and hence so is the metric subspace $S = \bigcup_\alpha B(k; \varphi_\alpha)$. The collection of all $B(k; \varphi_\alpha)$ is an open cover of S , and the separability gives us

⁷By Corollary 2.59 of *Basic*.

a countable subcover. Since the sets $B(k; \varphi_\alpha)$ are disjoint, we conclude that the set of all φ_α is countable. Hence E is at most countably infinite.

The next step is to bound E below under additional hypotheses as in the statement of the theorem. Let λ be in E , and let φ be a nonzero solution of (SL) corresponding to λ and normalized so that $\|\varphi\|_r = 1$. Multiplying (SL1) by $\bar{\varphi}$ and integrating, we have

$$\begin{aligned} \lambda &= \int_a^b \lambda |\varphi|^2 r \, dt = - \int_a^b (p\varphi')' \bar{\varphi} \, dt + \int_a^b q |\varphi|^2 \, dt \\ &= -[p\varphi' \bar{\varphi}]_a^b + \int_a^b p |\varphi'|^2 \, dt + \int_a^b q |\varphi|^2 \, dt \\ &\geq -p(b)\varphi'(b)\overline{\varphi(b)} + p(a)\varphi'(a)\overline{\varphi(a)} + \int_a^b (|\varphi|^2 r)(r^{-1}q) \, dt \\ &\geq -p(b)\varphi'(b)\overline{\varphi(b)} + p(a)\varphi'(a)\overline{\varphi(a)} + \inf_{a \leq t \leq b} \{r(t)^{-1}q(t)\}. \end{aligned}$$

Let us show under the hypotheses $c_1 c_2 \leq 0$ and $d_1 d_2 \geq 0$ that $\varphi'(a)\overline{\varphi(a)} \geq 0$ and $\varphi'(b)\overline{\varphi(b)} \leq 0$, and then the asserted lower bounds will follow. Condition (SL2) gives us $c_1 \varphi(a) + c_2 \varphi'(a) = 0$. If $c_1 = 0$ or $c_2 = 0$, then $\varphi'(a) = 0$ or $\varphi(a) = 0$, and hence $\varphi'(a)\overline{\varphi(a)} \geq 0$. If $c_1 c_2 \neq 0$, then $c_1 c_2 < 0$. The identity $c_1 \varphi(a) + c_2 \varphi'(a) = 0$ implies that $c_1^2 |\varphi(a)|^2 + c_1 c_2 \varphi'(a)\overline{\varphi(a)} = 0$ and hence $-c_1 c_2 \varphi'(a)\overline{\varphi(a)} = c_1^2 |\varphi(a)|^2 \geq 0$. Because of the condition $c_1 c_2 < 0$, we conclude that $\varphi'(a)\overline{\varphi(a)} \geq 0$. A similar argument using $d_1 d_2 \geq 0$ and $d_1 \varphi(b) + d_2 \varphi'(b) = 0$ shows that $\varphi'(b)\overline{\varphi(b)} \leq 0$. This completes the verification of the lower bounds for λ .

We have therefore established all the results in the theorem that are to be proved at this time except for

- (i) the existence of a countably infinite set of λ for which (SL) has a nonzero solution,
- (ii) the fact that E has no limit point in \mathbb{R} ,
- (iii) the assertion (a) about completeness.

Before carrying out these steps, we may need to adjust L slightly. We are studying functions u satisfying $L(u) + \lambda r u = 0$ and (SL2), and we have established that the set E of λ for which there is a nonzero solution is at most countably infinite. Choose a member λ_0 of the complementary set E^c and rewrite the differential equation as $M(u) + v r u = 0$, where $M(u) = L(u) + \lambda_0 r u$ and $v = (\lambda - \lambda_0)$. Then M has properties similar to those of L , and it has the further property that 0 is not a value of v for which $M(u) + v r u = 0$ and (SL2) together have a nonzero solution. It would be enough to prove (i), (ii), and (iii) for $M(u) + v r u = 0$ and (SL2). Adjusting notation, we may assume from the outset that 0 is not in E .

The next step is to prove the existence of a continuous real-valued function $G_1(t, s)$ on $[a, b] \times [a, b]$ such that $G_1(t, s) = G_1(s, t)$, such that the operator T_1 given by

$$T_1 f(t) = \int_a^b G_1(t, s) f(s) ds$$

carries the space $C[a, b]$ of continuous functions f on $[a, b]$ one-one onto the space $\mathcal{D}[a, b]$ of functions u on $[a, b]$ satisfying (SL2) and having two continuous derivatives on $[a, b]$, and such that $L : \mathcal{D}[a, b] \rightarrow C[a, b]$ is a two-sided inverse function to T_1 . The existence will be proved by an explicit construction that will be carried out as a lemma at the end of this section. The function $G_1(t, s)$ is called a **Green's function** for the operator L subject to the conditions (SL2). Assuming that a Green's function indeed exists, we next apply the Hilbert–Schmidt Theorem of Chapter II in the following form:

SPECIAL CASE OF HILBERT–SCHMIDT THEOREM. Let $G(t, s)$ be a continuous complex-valued function on $[a, b] \times [a, b]$ such that $G(t, s) = \overline{G(s, t)}$, and define

$$Tf(t) = \int_a^b G(t, s) f(s) ds$$

from the space $C[a, b]$ of continuous functions on $[a, b]$ to itself. Define an inner product $(f, g) = \int_a^b f(t) \overline{g(t)} dt$ and its corresponding norm $\| \cdot \|$ on $C[a, b]$. For each complex $\mu \neq 0$, define

$$V_\mu = \{ f : [a, b] \rightarrow \mathbb{C} \mid f \text{ is continuous and } T(f) = \mu f \}.$$

Then each V_μ is finite dimensional, the space $V_\mu \neq 0$ is nonzero for only countably many μ , the μ 's with $V_\mu \neq 0$ are all real, and for any $\epsilon > 0$, there are only finitely many μ with $V_\mu \neq 0$ and $|\mu| \geq \epsilon$. The spaces V_μ are mutually orthogonal with respect to the inner product (f, g) , and the continuous functions orthogonal to all V_μ are the continuous functions h with $T(h) = 0$. Let v_1, v_2, \dots be an enumeration of the union of orthogonal bases of the spaces V_μ with $\|v_j\| = 1$ for all j . Then for any continuous f on $[a, b]$,

$$T(f)(t) = \sum_{n=1}^{\infty} (T(f), v_n) v_n(t),$$

the series on the right side being absolutely uniformly convergent.

The theorem is applied not to our Green's function G_1 and the operator T_1 as above but to

$$G(t, s) = r(t)^{1/2} G_1(t, s) r(s)^{1/2}$$

and
$$Tf(t) = \int_a^b G(t, s) f(s) ds = r(t)^{1/2} T_1(r^{1/2} f)(t).$$

If $T(f) = \mu f$ for a real number $\mu \neq 0$, then we have $T_1(r^{1/2} f) = \mu r^{-1/2} f$. Application of L gives $r^{1/2} f = \mu L(r^{-1/2} f)$. If we put $u = r^{-1/2} f$, then we obtain $\mu L(u) = r^{1/2} f = r(r^{-1/2} f) = ru$. Hence $L(u) + \lambda ru = 0$ for $\lambda = -\mu^{-1}$. Also, the equation $u = r^{-1/2} f = \mu^{-1} T_1(r^{1/2} f)$ exhibits u as in the image of T_1 and shows that u satisfies (SL2). Conversely if $L(u) + \lambda ru = 0$ and u satisfies (SL2), recall that we arranged that 0 is not in E , so that λ has a reciprocal. Define $f = r^{1/2} u$. Application of T_1 to $L(u) + \lambda ru = 0$ gives $0 = u + \lambda T_1(ru) = r^{-1/2} f + \lambda T_1(r^{1/2} f)$. Then $T(f) = r^{1/2} T_1(r^{1/2} f) = -\lambda^{-1} f$. We conclude that the correspondence $f = r^{1/2} u$ exactly identifies the vector subspace of functions u in $\mathcal{D}[a, b]$ satisfying $L(u) + \lambda ru = 0$ with the vector subspace of functions f in $C[a, b]$ satisfying $T(f) = -\lambda^{-1} f$.

The statement of Sturm's Theorem gives us an enumeration $\lambda_1, \lambda_2, \dots$ of E . We know for each $\lambda = \lambda_n$ that the space of functions u solving (SL) for $\lambda = \lambda_n$ in E is 1-dimensional, and the statement of Sturm's Theorem has selected for us a function $u = \varphi_n$ solving (SL) such that $\|\varphi_n\|_r = 1$. Define $v_n = r^{1/2} \varphi_n$ and $\mu_n = -\lambda_n^{-1}$, so that $T(v_n) = \mu_n v_n$ and $\|v_n\| = \|\varphi_n\|_r = 1$. Because of the correspondence of μ 's and λ 's, the v_n may be taken as the complete list of vectors specified in the Hilbert–Schmidt Theorem. Since the φ_n 's are orthogonal for $(\cdot, \cdot)_r$, the v_n 's are orthogonal for (\cdot, \cdot) .

The operator T_1 has 0 kernel on $C[a, b]$, being invertible, and the formula for T in terms of T_1 shows therefore that T has 0 kernel. Thus the sequence μ_1, μ_2, \dots is infinite, and the Hilbert–Schmidt Theorem shows that it tends to 0. The corresponding sequence $\lambda_1, \lambda_2, \dots$ of negative reciprocals is then infinite and has no finite limit point. This proves results (i) and (ii) announced above.

Let u have two continuous derivatives on $[a, b]$ and satisfy (SL2). Then u is in the image of T_1 . Write $u = T_1(f)$ with f continuous, and put $g = r^{-1/2} f$. Then $u = T_1(f) = r^{-1/2} T(r^{-1/2} f) = r^{-1/2} T(g)$ and $(u, \varphi_n)_r = (T(g), v_n)$. Hence

$$r(t)^{1/2} u(t) = T(g)(t)$$

and
$$r(t)^{1/2} (u, \varphi_n)_r \varphi_n(t) = (T(g), v_n) v_n(t).$$

The Hilbert–Schmidt Theorem tells us that the series $\sum_{n=1}^{\infty} (T(g), v_n) v_n(t)$ converges absolutely uniformly to $T(g)(t)$. Because $r(t)^{1/2}$ is bounded above

and below by positive constants, it follows that the series $\sum_{n=1}^{\infty} (u, \varphi_n)_r \varphi_n(t)$ converges absolutely uniformly to $u(t)$. This proves result (iii), i.e., the completeness assertion (a) in the statement of Sturm's Theorem, and we are done for now except for the proof of the existence of the Green's function G_1 . \square

Lemma 1.4. Under the assumption that there is no nonzero solution of (SL) for $\lambda = 0$, there exists a continuous real-valued function $G_1(t, s)$ on $[a, b] \times [a, b]$ such that $G_1(t, s) = G_1(s, t)$, such that the operator T_1 given by

$$T_1 f(t) = \int_a^b G(t, s) f(s) ds$$

carries the space $C[a, b]$ of continuous functions f on $[a, b]$ one-one onto the space $\mathcal{D}[a, b]$ of functions u on $[a, b]$ satisfying (SL2) and having two continuous derivatives on $[a, b]$, and such that $L : \mathcal{D}[a, b] \rightarrow C[a, b]$ is a two-sided inverse function to T_1 .

PROOF. Since $L(u) = pu'' + p'u' - qu$, a solution of $L(u) = 0$ has $u'' = -p^{-1}p'u' + p^{-1}qu$. Fix a point c in $[a, b]$. Let $\varphi_1(t)$ and $\varphi_2(t)$ be the unique solutions of $L(u) = 0$ on $[a, b]$ satisfying

$$\varphi_1(c) = 1 \text{ and } \varphi_1'(c) = 0, \quad \varphi_2(c) = 0 \text{ and } \varphi_2'(c) = 1.$$

Since the complex conjugate of φ_1 or φ_2 satisfies the same conditions, we must have $\bar{\varphi}_1 = \varphi_1$ and $\bar{\varphi}_2 = \varphi_2$. Hence φ_1 and φ_2 are real-valued. The associated Wronskian matrix is

$$W(\varphi_1, \varphi_2)(t) = \begin{pmatrix} \varphi_1(t) & \varphi_2(t) \\ \varphi_1'(t) & \varphi_2'(t) \end{pmatrix},$$

and its determinant is

$$\det W(\varphi_1, \varphi_2)(t) = \varphi_1(t)\varphi_2'(t) - \varphi_1'(t)\varphi_2(t).$$

Then $\det W(\varphi_1, \varphi_2)(c) = 1$ and $\det W(\varphi_1, \varphi_2)(t)$ satisfies the first-order linear homogeneous differential equation

$$\begin{aligned} (\det W(\varphi_1, \varphi_2))' &= \varphi_1\varphi_2'' - \varphi_1''\varphi_2 \\ &= \varphi_1(-p^{-1}p'\varphi_2' + p^{-1}q\varphi_2) - \varphi_2(-p^{-1}p'\varphi_1' + p^{-1}q\varphi_1) \\ &= -p^{-1}p'(\varphi_1\varphi_2' - \varphi_1'\varphi_2) \\ &= -p^{-1}p' \det W(\varphi_1, \varphi_2). \end{aligned}$$

Therefore

$$\begin{aligned}\det W(\varphi_1, \varphi_2)(t) &= \exp\left(-\int_c^t p'(s)/p(s) ds\right) = \exp\left(-\log p(t) + \log p(c)\right) \\ &= \exp(\log(p(c)/p(t))) = p(c)/p(t).\end{aligned}$$

For f continuous, consider the solutions of the equation $L(u) = f$. A specific solution is given by variation of parameters, as stated in Theorem 4.9 of *Basic*. To use the formula in that theorem, we need L to have leading coefficient 1. For that purpose, we rewrite $L(u) = f$ as $u'' + p^{-1}p'u' - p^{-1}qu = p^{-1}f$. The theorem shows that one solution $u^*(t)$ is given by the first entry of

$$W(\varphi_1, \varphi_2)(t) \int_a^t W(\varphi_1, \varphi_2)(s)^{-1} \begin{pmatrix} 0 \\ p^{-1}(s)f(s) \end{pmatrix} ds.$$

Since $W(\varphi_1, \varphi_2)(s)^{-1} = (\det W(\varphi_1, \varphi_2)(s))^{-1} \begin{pmatrix} \varphi_2'(s) & -\varphi_2(s) \\ -\varphi_1'(s) & \varphi_1(s) \end{pmatrix}$, the result is

$$\begin{aligned}u^*(t) &= \int_a^t \frac{-\varphi_1(t)\varphi_2(s)p^{-1}(s)f(s) + \varphi_2(t)\varphi_1(s)p^{-1}(s)f(s)}{p(c)/p(s)} ds \\ &= p(c)^{-1} \int_a^t (-\varphi_1(t)\varphi_2(s) + \varphi_2(t)\varphi_1(s))f(s) ds.\end{aligned}$$

Define

$$G_0(t, s) = \begin{cases} p(c)^{-1}(-\varphi_1(t)\varphi_2(s) + \varphi_2(t)\varphi_1(s)) & \text{if } s \leq t, \\ 0 & \text{if } s > t. \end{cases}$$

This function is continuous everywhere on $[a, b] \times [a, b]$, including where $s = t$, and it has been constructed so that

$$u^*(t) = \int_a^t G_0(t, s)f(s) ds = \int_a^b G_0(t, s)f(s) ds$$

is a solution of $u'' + p^{-1}p'u' - p^{-1}qu = p^{-1}f$, i.e., of $L(u) = f$. In particular, the form of the equation shows that u^* has two continuous derivatives on $[a, b]$. Therefore the operator

$$T_0(f)(t) = \int_a^b G_0(t, s)f(s) ds$$

carries $C[a, b]$ into the space of twice continuously differentiable functions on $[a, b]$.

The final step is to adjust G_0 and T_0 so that the operator produces twice continuously differentiable functions satisfying (SL2). Fix f continuous, and let $u^*(t) = \int_a^b G_0(t, s) f(s) ds$. By assumption the equation $L(u) = 0$ has no nonzero solution that satisfies (SL2). Thus the function $\varphi(t) = x_1\varphi_1(t) + x_2\varphi_2(t)$ does not have both

$$c_1\varphi(a) + c_2\varphi'(a) = 0 \quad \text{and} \quad d_1\varphi(b) + d_2\varphi'(b) = 0$$

unless x_1 and x_2 are both 0. In other words the homogeneous system of equations

$$\begin{pmatrix} c_1\varphi_1(a) + c_2\varphi_1'(a) & c_1\varphi_2(a) + c_2\varphi_2'(a) \\ d_1\varphi_1(b) + d_2\varphi_1'(b) & d_1\varphi_2(b) + d_2\varphi_2'(b) \end{pmatrix} \begin{pmatrix} x_1 \\ x_2 \end{pmatrix} = \begin{pmatrix} 0 \\ 0 \end{pmatrix}$$

has only the trivial solution. Consequently the system given by

$$\begin{pmatrix} c_1\varphi_1(a) + c_2\varphi_1'(a) & c_1\varphi_2(a) + c_2\varphi_2'(a) \\ d_1\varphi_1(b) + d_2\varphi_1'(b) & d_1\varphi_2(b) + d_2\varphi_2'(b) \end{pmatrix} \begin{pmatrix} k_1 \\ k_2 \end{pmatrix} = - \begin{pmatrix} c_1u^*(a) + c_2u^{*'}(a) \\ d_1u^*(b) + d_2u^{*'}(b) \end{pmatrix} \quad (*)$$

has a unique solution $\begin{pmatrix} k_1 \\ k_2 \end{pmatrix}$ for fixed f . We need to know how k_1 and k_2 depend on f . From the form of G_0 , we have

$$u^*(t) = p(c)^{-1} \left(-\varphi_1(t) \int_a^t \varphi_2(s) f(s) ds + \varphi_2(t) \int_a^t \varphi_1(s) f(s) ds \right).$$

By inspection, two terms in the differentiation drop out and the derivative is

$$u^{*'}(t) = p(c)^{-1} \left(-\varphi_1'(t) \int_a^t \varphi_2(s) f(s) ds + \varphi_2'(t) \int_a^t \varphi_1(s) f(s) ds \right).$$

Evaluation of these formulas at a and b gives

$$\begin{aligned} u^*(a) &= u^{*'}(a) = 0, \\ u^*(b) &= p(c)^{-1} \left(-\varphi_1(b) \int_a^b \varphi_2(s) f(s) ds + \varphi_2(b) \int_a^b \varphi_1(s) f(s) ds \right), \\ u^{*'}(b) &= p(c)^{-1} \left(-\varphi_1'(b) \int_a^b \varphi_2(s) f(s) ds + \varphi_2'(b) \int_a^b \varphi_1(s) f(s) ds \right). \end{aligned}$$

Thus the right side of the equation (*) that defines k_1 and k_2 is of the form

$$- \begin{pmatrix} c_1u^*(a) + c_2u^{*'}(a) \\ d_1u^*(b) + d_2u^{*'}(b) \end{pmatrix} = \begin{pmatrix} 0 \\ \int_a^b (e_1\varphi_1(s) + e_2\varphi_2(s)) f(s) ds \end{pmatrix},$$

where e_1 and e_2 are real constants independent of f . Hence k_1 and k_2 are of the form

$$\begin{pmatrix} k_1 \\ k_2 \end{pmatrix} = \begin{pmatrix} \int_a^b (\alpha\varphi_1(s) + \beta\varphi_2(s))f(s) ds \\ \int_a^b (\gamma\varphi_1(s) + \delta\varphi_2(s))f(s) ds \end{pmatrix},$$

where $\alpha, \beta, \gamma, \delta$ are real constants independent of f . The fact that $\begin{pmatrix} k_1 \\ k_2 \end{pmatrix}$ solves the system (*) means that the function $v(t)$ given by

$$u^*(t) + \varphi_1(t) \int_a^b (\alpha\varphi_1(s) + \beta\varphi_2(s))f(s) ds + \varphi_2(t) \int_a^b (\gamma\varphi_1(s) + \delta\varphi_2(s))f(s) ds$$

satisfies $c_1v(a) + c_2v'(a) = 0$ and $d_1v(b) + d_2v'(b) = 0$. Put

$$\begin{pmatrix} K_1(s) \\ K_2(s) \end{pmatrix} = \begin{pmatrix} \alpha\varphi_1(s) + \beta\varphi_2(s) \\ \gamma\varphi_1(s) + \delta\varphi_2(s) \end{pmatrix}.$$

We can summarize the above computation by saying that the real-valued continuous function

$$G_1(t, s) = G_0(t, s) + K_1(s)\varphi_1(t) + K_2(s)\varphi_2(t)$$

has, for every continuous f , the property that $v(t) = \int_a^b G_1(t, s)f(s) ds$ satisfies $L(v) = f$ and the condition (SL2).

Define $T_1(f)(t) = \int_a^b G_1(t, s)f(s) ds$. We have seen that T_1 carries $C[a, b]$ into $\mathcal{D}[a, b]$ and that $L(T_1(f)) = f$. Now suppose that u is in $\mathcal{D}[a, b]$. Since $L(u)$ is continuous, $T_1(L(u))$ is in $\mathcal{D}[a, b]$ and has $L(T_1(L(u))) = L(u)$. Therefore $T_1(L(u)) - u$ is in $\mathcal{D}[a, b]$ and has $L(T_1(L(u)) - u) = 0$. We have assumed that there is no nonzero solution of (SL) for $\lambda = 0$, and therefore $T_1(L(u)) = u$. Thus T_1 and L are two-sided inverses of one another.

Finally we are to prove that $G_1(t, s) = G_1(s, t)$. Let f and g be arbitrary real-valued continuous functions on $[a, b]$, and put $u = T_1(f)$ and $v = T_1(g)$. We know from Green's formula and (SL2) that $(L(u), v) = (u, L(v))$. Substituting the formulas $f = L(u)$ and $g = L(v)$ into this equality gives

$$\begin{aligned} \int_a^b \int_a^b G_1(t, s)f(t)g(s) ds dt &= \int_a^b f(t)v(t) dt = (L(u), v) \\ &= (u, L(v)) = \int_a^b u(s)g(s) ds = \int_a^b \int_a^b G_1(s, t)f(t)g(s) dt ds. \end{aligned}$$

By Fubini's Theorem the identity

$$\int_a^b \int_a^b (G_1(t, s) - G_1(s, t))F(s, t) dt ds = 0$$

holds when F is one of the linear combinations of continuous functions $f(s)g(t)$. We can extend this conclusion to general continuous F by passing to the limit and using uniform convergence because the Stone–Weierstrass Theorem shows that real linear combinations of products $f(t)g(s)$ are uniformly dense in the space of continuous real-valued functions on $[a, b] \times [a, b]$. Taking $F(s, t) = G_1(t, s) - G_1(s, t)$, we see that $\int_a^b \int_a^b (G_1(t, s) - G_1(s, t))^2 dt ds = 0$. Therefore $G_1(t, s) - G_1(s, t) = 0$ and $G_1(t, s) = G_1(s, t)$. This completes the proof of the lemma. \square

HISTORICAL REMARKS. Sturm’s groundbreaking paper appeared in 1836. In that paper he proved that the set E in Theorem 1.3’ is infinite by comparing the zeros of solutions of various equations, but he did not address the question of completeness. Liouville introduced integral equations in 1837.

4. Problems

1. Let p_n be the n^{th} -smallest positive real number p such that $h \sin pl + p \cos pl = 0$, as in Example 3 for the heat equation in Section 2. Here h and l are positive constants. Prove directly that $\int_0^l \sin p_n x \sin p_m x dx = 0$ for $n \neq m$ by substituting from the trigonometric identity $\sin a \sin b = -\frac{1}{2}(\cos(a + b) - \cos(a - b))$.
2. Multiplying the relevant differential operators by functions to make them formally self adjoint, and applying Green’s formula from Section 3, prove the following orthogonality relations:
 - (a) $\int_{-1}^1 P_n(t)P_m(t) dt = 0$ if P_n and P_m are Legendre polynomials and $n \neq m$. The m^{th} Legendre polynomial P_m is a certain nonzero polynomial solution of the Legendre equation $(1 - t^2)P'' - 2tP' + m(m + 1)P = 0$. It is unique up to a scalar factor. These polynomials are applied in the second example with the Laplace equation in Section 2.
 - (b) $\int_0^1 J_0(k_n r)J_0(k_m r)r dr = 0$ if k_n and k_m are distinct zeros of the Bessel function J_0 . The function J_0 is the power series solution $J_0(t) = \sum_{n=0}^{\infty} \frac{(-1)^n t^{2n}}{(n!)^2}$ of the Bessel equation of order 0, namely $t^2 y'' + t y' + t^2 y = 0$. It is applied in the last example of Section 2.
3. In the proof of Lemma 1.4:
 - (a) Show directly by expanding out $u^*(t) = \int_a^t G_0(t, s)f(s) ds$ that u^* satisfies $L(u^*) = f$.
 - (b) Calculate $G_0(t, s)$ and $G_1(t, s)$ explicitly for the case that $L(u) = u'' + u$ when the conditions (SL2) are that $u(0) = 0$ and $u(\pi/2) = 0$.

4. This problem discusses the starting point for Sturm's original theory. Suppose that $p(t)$, $p'(t)$, $g_1(t)$, and $g_2(t)$ are real-valued and continuous on $[a, b]$ and that $p(t) > 0$ and $g_2(t) > g_1(t)$ everywhere on $[a, b]$. Let $y_1(t)$ and $y_2(t)$ be real-valued solutions of the respective equations

$$(p(t)y_1')' + g_1(t)y_1 = 0 \quad \text{and} \quad (p(t)y_2')' + g_2(t)y_2 = 0.$$

Follow the steps below to show that if t_1 and t_2 are consecutive zeros of $y_1(t)$, then $y_2(t)$ vanishes somewhere on (t_1, t_2) .

- (a) Arguing by contradiction and assuming that $y_2(t)$ is nonvanishing on (t_1, t_2) , normalize matters so that $y_1(t) > 0$ and $y_2(t) > 0$ on (t_1, t_2) . Multiply the first equation by y_2 , the second equation by y_1 , subtract, and integrate over $[t_1, t_2]$. Conclude from this computation that $[py_1'y_2 - py_1y_2']_{t_1}^{t_2} > 0$.
- (b) Taking the signs of p , y_1 , y_2 and the behavior of the derivatives into account, prove that $p(t)y_1'(t)y_2(t) - p(t)y_1(t)y_2'(t)$ is ≤ 0 at $t = t_2$ and is ≥ 0 at t_1 , in contradiction to the conclusion of (a). Conclude that $y_2(t)$ must have equaled 0 somewhere on (t_1, t_2) .
- (c) Suppose in addition that $q(t)$ and $r(t)$ are continuous on $[a, b]$ and that $r(t) > 0$ everywhere. Let $y_1(t)$ and $y_2(t)$ be real-valued solutions of the respective equations

$$(p(t)y_1')' - q(t)y_1 + \lambda_1 r(t)y_1 = 0 \quad \text{and} \quad (p(t)y_2')' - q(t)y_2 + \lambda_2 r(t)y_2 = 0,$$

where λ_1 and λ_2 are real with $\lambda_1 < \lambda_2$. Obtain as a corollary of (b) that $y_2(t)$ vanishes somewhere on the interval between two consecutive zeros of $y_1(t)$.

Problems 5–8 concern Schrödinger's equation in one space dimension with a time-independent potential $V(x)$. In suitable units the equation is

$$-\frac{\partial^2 \Psi(x, t)}{\partial x^2} + V(x)\Psi(x, t) = i \frac{\partial \Psi(x, t)}{\partial t}.$$

5. (a) Show that any solution of the form $\Psi(x, t) = \psi(x)\varphi(t)$ is such that $\psi'' + (E - V(x))\psi = 0$ for some constant E .
- (b) Compute what the function $\varphi(t)$ must be in (a).
6. Suppose that $V(x) = x^2$, so that $\psi'' + (E - x^2)\psi = 0$. Put $\psi(x) = e^{-x^2/2}H(x)$, and show that

$$H'' - 2xH' + (E - 1)H = 0.$$

This ordinary differential equation is called **Hermite's equation**.

7. Solve the equation $H'' - 2xH' + 2nH = 0$ by power series. Show that there is a nonzero polynomial solution if and only if n is an integer ≥ 0 , and in this case the polynomial is unique up to scalar multiplication and has degree n . For a suitable normalization the polynomial is denoted by $H_n(x)$ and is called a **Hermite polynomial**.

8. Guided by Problem 6, let L be the formally self-adjoint operator

$$L(\psi) = \psi'' - x^2\psi.$$

Using Green's formula from Section 3 for this L on the interval $[-N, N]$ and letting N tend to infinity, prove that

$$\lim_{N \rightarrow \infty} \int_{-N}^N H_n(x)H_m(x)e^{-x^2} dx = 0 \quad \text{if } n \neq m.$$

CHAPTER II

Compact Self-Adjoint Operators

Abstract. This chapter proves a first version of the Spectral Theorem and shows how it applies to complete the analysis in Sturm’s Theorem of Section I.3.

Section 1 introduces compact linear operators from a Hilbert space into itself and characterizes them as the limits in the operator norm topology of the linear operators of finite rank. The adjoint of a compact operator is compact.

Section 2 proves the Spectral Theorem for compact self-adjoint operators on a Hilbert space, showing that such operators have orthonormal bases of eigenvectors with eigenvalues tending to 0.

Section 3 establishes two versions of the Hilbert–Schmidt Theorem concerning self-adjoint integral operators with a square-integrable kernel. The abstract version gives an L^2 expansion of the members of the image of the operator in terms of eigenfunctions, and the concrete version, valid when the kernel is continuous and the space is compact metric, proves that the eigenfunctions are continuous and the expansion in terms of eigenfunctions is uniformly convergent.

Section 4 introduces unitary operators on a Hilbert space, establishing the equivalence of three conditions that may be used to define them.

Section 5 studies compact linear operators on an abstract Hilbert space, with special attention to two kinds—the Hilbert–Schmidt operators and the operators of trace class. All three sets of operators—compact, Hilbert–Schmidt, and trace-class—are ideals in the algebra of all bounded linear operators and are closed under the operation of adjoint. Trace-class implies Hilbert–Schmidt, which implies compact. The product of two Hilbert–Schmidt operators is of trace class.

1. Compact Operators

Let H be a real or complex Hilbert space with inner product¹ (\cdot, \cdot) and norm $\|\cdot\|$. A bounded linear operator $L : H \rightarrow H$ is said to be **compact** if L carries the closed unit ball of H to a subset of H that has compact closure, i.e., if each bounded sequence $\{u_n\}$ in H has the property that $\{L(u_n)\}$ has a convergent subsequence.² The first three conclusions of the next proposition together give a characterization of the compact operators on H .

¹This book follows the convention that inner products are linear in the first variable and conjugate linear in the second variable.

²Some books use the words “completely continuous” in place of “compact” for this kind of operator.

Proposition 2.1. Let $L : H \rightarrow H$ be a bounded linear operator on a Hilbert space H . Then

- (a) L is compact if the image of L is finite dimensional,
- (b) L is compact if L is the limit, in the operator norm, of a sequence of compact operators,
- (c) L compact implies that there exist bounded linear operators $L_n : H \rightarrow H$ such that $L = \lim L_n$ in the operator norm and the image of each L_n is finite dimensional,
- (d) L compact implies L^* compact.

PROOF. For (a), let M be the image of L . Being finite dimensional, M is closed and is hence a Hilbert space. Let $\{v_1, \dots, v_k\}$ be an orthonormal basis. The linear mapping that carries each v_j to the j^{th} standard basis vector e_j in the space of column vectors is then a linear isometry of M onto \mathbb{R}^k or \mathbb{C}^k . In \mathbb{R}^k and \mathbb{C}^k , the closed ball about 0 of radius $\|L\|$ is compact, and hence the closed ball about 0 of radius $\|L\|$ in M is compact. The latter closed ball contains the image of the closed unit ball of H under L , and hence L is compact.

For (b), let B be the closed unit ball of H . Write $L = \lim L_n$ in the operator norm, each L_n being compact. Since the subsets of a complete metric space having compact closure are exactly the totally bounded subsets, it is enough to prove that $L(B)$ is totally bounded. Let $\epsilon > 0$ be given, and choose n large enough so that $\|L_n - L\| < \epsilon/2$. With n fixed, $L_n(B)$ is totally bounded since $L_n(B)$ is assumed to have compact closure. Thus we can find finitely many points v_1, \dots, v_k such that the open balls of radius $\epsilon/2$ about the v_j 's together cover $L_n(B)$. We shall prove that the open balls of radius ϵ about the v_j 's together cover $L(B)$. In fact, if u is given with $\|u\| \leq 1$, choose j with $\|L_n(u) - v_j\| < \epsilon/2$. Then $\|L(u) - v_j\| \leq \|L(u) - L_n(u)\| + \|L_n(u) - v_j\| < \|L_n - L\|\|u\| + \frac{\epsilon}{2} \leq \frac{\epsilon}{2} + \frac{\epsilon}{2} = \epsilon$, as required.

For (c), we may assume that H is infinite dimensional. Since L is compact, there exists a compact subset K of H containing the image of the closed unit ball. As a compact metric space, K is separable. Let $\{w_n\}$ be a countable dense set, and let M be the smallest closed vector subspace of H containing all w_n . Since the closure of $\{w_n\}$ contains K , M contains K . The subspace M is separable: in fact, if the scalars are real, then the set of all rational linear combinations of the w_n 's is a countable dense set; if the scalars are complex, then we obtain a countable dense set by allowing the scalars to be of the form $a + bi$ with a and b rational.

Since M is a closed vector subspace, it is a Hilbert space and has an orthonormal basis S . The set S must be countable since the open balls of radius $1/2$ centered at the members of S are disjoint and would otherwise contradict the fact that every topological subspace of a separable topological space is Lindelöf. Thus let us

list the members of S as v_1, v_2, \dots . For each n , let M_n be the (closed) linear span of $\{v_1, \dots, v_n\}$, and let E_n be the orthogonal projection on M_n . The linear operator $E_n L$ is bounded, being a composition of bounded linear operators, and its image is contained in the finite-dimensional space M_n . Hence it is enough to show for each $\epsilon > 0$ that there is some n with $\|(1 - E_n)L\| < \epsilon$. If this condition were to fail, we could find some $\epsilon > 0$ such that $\|(1 - E_n)L\| \geq \epsilon$ for every n . With ϵ fixed in this way, choose for each n some vector u_n of norm 1 such that $\|(1 - E_n)L(u_n)\| \geq \epsilon/2$. The sequence $\{L(u_n)\}$ lies in the compact set K . Choose a convergent subsequence $\{L(u_{n_k})\}$, and let $v = \lim L(u_{n_k})$. For n_k sufficiently large, we have $\|v - L(u_{n_k})\| \leq \epsilon/4$. In this case,

$$\|(1 - E_{n_k})v\| \geq \|(1 - E_{n_k})L(u_{n_k})\| - \|(1 - E_{n_k})(v - L(u_{n_k}))\| \geq \frac{\epsilon}{2} - \frac{\epsilon}{4} = \frac{\epsilon}{4}.$$

On the other hand, v is in M , and v is of the form $v = \sum_{j=1}^{\infty} (v, v_j)v_j$. In this expression we have $E_n(v) = \sum_{j=1}^n (v, v_j)v_j$, and these partial sums converge to v in H . In short, $\lim_n E_n v = v$. Then $\|(1 - E_n)v\|$ tends to 0, and this contradicts our estimate $\|(1 - E_{n_k})v\| \geq \frac{\epsilon}{4}$.

For (d), first suppose that the image of L is finite dimensional, and choose an orthonormal basis $\{u_1, \dots, u_n\}$ of the image. Then $L(u) = \sum_{j=1}^n (L(u), u_j)u_j = \sum_{j=1}^n (u, L^*(u_j))u_j$. Taking the inner product with v gives $(u, L^*(v)) = (L(u), v) = \sum_{j=1}^n (u, L^*(u_j))(u_j, v)$. This equality shows that $L^*(v)$ and $\sum_{j=1}^n (v, u_j)L^*(u_j)$ have the same inner product with every u . Thus they must be equal, and we conclude that the image of L^* is finite dimensional.

Now suppose that L is any compact operator on H . Given $\epsilon > 0$, use (c) to choose a bounded linear operator L_n with finite-dimensional image such that $\|L - L_n\| < \epsilon$. Since a bounded linear operator and its adjoint have the same norm, $\|L^* - L_n^*\| < \epsilon$. Since L_n^* has finite-dimensional image, according to what we have just seen, and since we can obtain such an approximation for any $\epsilon > 0$, (b) shows that L^* is compact. \square

2. Spectral Theorem for Compact Self-Adjoint Operators

Let $L : H \rightarrow H$ be a bounded linear operator on the real or complex Hilbert space H . One says that a nonzero vector v is an **eigenvector** of L if $L(v) = cv$ for some constant c ; the constant c is called the corresponding **eigenvalue**. The set of all u for which $L(u) = cu$ is a closed vector subspace; under the assumption that this subspace is not 0, it is called the **eigenspace** for the eigenvalue c .

In the finite-dimensional case, the self-adjointness condition $L^* = L$ means that L corresponds to a **Hermitian matrix** A , i.e., a matrix equal to its conjugate transpose, once one fixes an ordered orthonormal basis. In this case it is shown

in linear algebra that the members of an orthonormal basis can be chosen to be eigenvectors of L , the eigenvalues all being real. In terms of matrices, the corresponding matrix A is conjugate via a **unitary matrix**, i.e., a matrix whose conjugate transpose is its inverse, to a diagonal matrix with real entries. This result is called the Spectral Theorem for such linear operators or matrices. A quick proof goes as follows: An eigenvector v of L with eigenvalue c has $(L - cI)(v) = 0$, and this implies that the matrix A of L has the property that $A - cI$ has a nonzero null space. Hence $\det(A - cI) = 0$ if and only if c is an eigenvalue of L . One readily sees from the self-adjointness of L that all complex roots of $\det(A - cI)$ have to be real. Moreover, if L carries a vector subspace M into itself, then L carries M^\perp into itself as well. Finite-dimensionality forces A to have a complex eigenvalue, and this must be real. Hence there is a nonzero vector u with $L(u) = cu$ for some real c . Normalizing, we may assume that u has norm 1. If M consists of the scalar multiples of u , then L carries M^\perp to itself, and the restriction of L to M^\perp is self adjoint. Proceeding inductively, we obtain a system of orthogonal eigenvectors for L , each of norm 1.

A certain amount of this argument works in the infinite-dimensional case. In fact, suppose that L is self adjoint. Then any u in H has

$$(L(u), u) = (u, L^*(u)) = (u, L(u)) = \overline{(L(u), u)},$$

and hence the function $u \mapsto (L(u), u)$ is real-valued. If u is an eigenvector in H with eigenvalue c , i.e., if $L(u) = cu$, then $c(u, u) = (L(u), u)$ is real; since (u, u) is real and nonzero, c is real. If u_1 and u_2 are eigenvectors for distinct eigenvalues c_1 and c_2 , then u_1 and u_2 are orthogonal because

$$(c_1 - c_2)(u_1, u_2) = (c_1 u_1, u_2) - (u_1, c_2 u_2) = (L(u_1), u_2) - (u_1, L(u_2)) = 0.$$

If M is a vector subspace of H with $L(M) \subseteq M$, then also $L(M^\perp) \subseteq M^\perp$ because $m \in M$ and $m^\perp \in M^\perp$ together imply

$$0 = (L(m), m^\perp) = (m, L(m^\perp)).$$

These observations prove everything in the following proposition except the last statement.

Proposition 2.2. If $L : H \rightarrow H$ is a bounded self-adjoint linear operator on a Hilbert space H , then $u \mapsto (L(u), u)$ is real-valued, every eigenvalue of L is real, eigenvectors under L for distinct eigenvalues are orthogonal, and every vector subspace M with $L(M) \subseteq M$ has $L(M^\perp) \subseteq M^\perp$. In addition,

$$\|L\| = \sup_{\|u\| \leq 1} |(L(u), u)|.$$

PROOF. We are left with proving the displayed formula. Inequality in one direction is easy: we have

$$\sup_{\|u\|\leq 1} |(L(u), u)| \leq \sup_{\substack{\|u\|\leq 1, \\ \|v\|\leq 1}} |(L(u), v)| = \|L\|.$$

With $C = \sup_{\|u\|\leq 1} |(L(u), u)|$, we are therefore to prove that $\|L\| \leq C$, hence that $\|L(u)\| \leq C\|u\|$ for all u . In doing so, we may assume that $u \neq 0$ and $L(u) \neq 0$. Let t be a positive real number. Since $(L^2(u), u) = (L(u), L(u))$, we have

$$\begin{aligned} \|L(u)\|^2 &= \frac{1}{4} \left[(L(tu + t^{-1}L(u)), tu + t^{-1}L(u)) - (L(tu - t^{-1}L(u)), tu - t^{-1}L(u)) \right] \\ &\leq \frac{1}{4} \left[C\|tu + t^{-1}L(u)\|^2 + C\|tu - t^{-1}L(u)\|^2 \right] \\ &= \frac{1}{2} C \left[\|tu\|^2 + \|t^{-1}L(u)\|^2 \right], \end{aligned}$$

the last step following from the parallelogram law. By differential calculus the minimum of an expression $a^2t^2 + b^2t^{-2}$, in which a and b are positive constants, is attained when $t^2 = b/a$. Here $a = \|u\|$ and $b = \|L(u)\|$, and thus $\|L(u)\|^2 \leq \frac{C}{2} [\|L(u)\|\|u\| + \|L(u)\|\|u\|] = C\|L(u)\|\|u\|$. Dividing by $\|L(u)\|$ gives $\|L(u)\| \leq C\|u\|$ and completes the proof. \square

In the infinite-dimensional case, in which we work with the operator L but no matrix, consider what is needed to imitate the proof of the finite-dimensional Spectral Theorem and thereby find an orthonormal basis of vectors carried by L to multiples of themselves. In the formula of Proposition 2.2, if we can find some u with $\|u\| = 1$ such that $\|L\| = |(L(u), u)|$, then this u satisfies $\|L\|\|u\|^2 = |(L(u), u)| \leq \|L(u)\|\|u\| \leq \|L\|\|u\|^2$, and we conclude that $|(L(u), u)| = \|L(u)\|\|u\|$, i.e., that equality holds in the Schwarz inequality. Reviewing the proof of the Schwarz inequality, we see that $L(u)$ and u are proportional. Thus u is an eigenvector of L , and we can at least get started with the proof.

Unfortunately an orthonormal basis of eigenvectors need not exist for a self-adjoint L without an extra hypothesis. In fact, take $H = L^2([0, 1])$ with $(f, g) = \int_0^1 f\bar{g} dx$, and define $L(f)(x) = xf(x)$. This linear operator L has norm 1, and the equality $(f, L(g)) = \int_0^1 xf(x)\overline{g(x)} dx = (L(f), g)$ shows that L is self adjoint. On the other hand, the only function f with $xf = cf$ a.e. for some constant c is the 0 function. Thus we get no eigenvectors at all, and the supremum in the formula of Proposition 2.2 need not be attained.

The hypothesis that we shall add to obtain an orthonormal basis of eigenvectors is that L is compact in the sense of the previous section. Each compact self-adjoint operator has an orthonormal basis of eigenvectors, according to the following theorem.

Theorem 2.3 (Spectral Theorem for compact self-adjoint operators). Let $L : H \rightarrow H$ be a compact self-adjoint linear operator on a real or complex Hilbert space H . Then H has an orthonormal basis of eigenvectors of L . In addition, for each scalar λ , let

$$H_\lambda = \{u \in H \mid L(u) = \lambda u\},$$

so that $H_\lambda - \{0\}$ consists exactly of the eigenvectors of L with eigenvalue λ . Then the number of eigenvalues of L is countable, the eigenvalues are all real, the spaces H_λ are mutually orthogonal, each H_λ for $\lambda \neq 0$ is finite dimensional, any orthonormal basis of H of eigenvectors under L is the union of orthonormal bases of the H_λ 's, and for any $\epsilon > 0$, there are only finitely many λ with $H_\lambda \neq 0$ and $|\lambda| \geq \epsilon$. Moreover, either or both of $\|L\|$ and $-\|L\|$ are eigenvalues, and these are the eigenvalues with the largest absolute value.

PROOF. We know from Proposition 2.2 that the eigenvalues of L are all real and that the spaces H_λ are mutually orthogonal. In addition, the formula $\|L\| = \sup_{\|u\| \leq 1} \|L(u)\|$ shows that no eigenvalue can be greater than $\|L\|$ in absolute value.

The theorem certainly holds if $L = 0$ since every nonzero vector is an eigenvector. Thus we may assume that $\|L\| > 0$.

The main step is to produce an eigenvector with one of $\|L\|$ and $-\|L\|$ as eigenvalue. Taking the equality $\|L\| = \sup_{\|u\| \leq 1} |(L(u), u)|$ of Proposition 2.2 into account, choose a sequence $\{u_n\}$ with $\|u_n\| = 1$ such that $\lim_n |(L(u_n), u_n)| = \|L\|$. Since the proposition shows that $(L(u_n), u_n)$ has to be real, we may assume that this sequence is chosen so that $\lambda = \lim_n (L(u_n), u_n)$ exists. Then $\lambda = \pm\|L\|$. Using the compactness of L and passing to a subsequence if necessary, we may assume that $L(u_n)$ converges to some limit v_0 . Meanwhile,

$$\begin{aligned} 0 \leq \|L(u_n) - \lambda u_n\|^2 &= \|L(u_n)\|^2 - 2\lambda \operatorname{Re}(L(u_n), u_n) + \lambda^2 \|u_n\|^2 \\ &\leq \|L\|^2 - 2\lambda \operatorname{Re}(L(u_n), u_n) + \lambda^2. \end{aligned}$$

The equalities $\lambda^2 = \|L\|^2$ and $\lim_n (L(u_n), u_n) = \lambda$ show that the right side tends to 0, and thus $\lim_n \|L(u_n) - \lambda u_n\| = 0$. Since $\lim_n \|L(u_n) - v_0\| = 0$ also, the triangle inequality shows that $\lim \lambda u_n$ exists and equals v_0 . Since $\lambda \neq 0$, $\lim u_n$ exists and $v_0 = \lambda \lim u_n$. Consequently $\|v_0\| = |\lambda| \lim \|u_n\| = |\lambda| = \|L\| \neq 0$. Applying L to the equation $v_0 = \lambda \lim u_n$ and taking into account that L is continuous and that $\lim L(u_n) = v_0$, we see that $L(v_0) = \lambda v_0$. Thus v_0 is an eigenvector with eigenvalue λ , and the main step is complete.

Now consider the collection of all orthonormal systems of eigenvectors for L , and order it by inclusion upward. A chain consists of nested such systems, and the union of the members of a chain is again such an orthonormal system. By Zorn's Lemma the collection contains a maximal element S . Let M be the smallest closed vector subspace containing this maximal orthonormal system S of eigenvectors. Since the collection of all finite linear combinations of members of S is dense in M , the continuity of L shows that $L(M) \subseteq M$. By Proposition 2.2, $L(M^\perp) \subseteq M^\perp$. The equality $(L(u), v) = (u, L(v))$ for any two members u and v of M^\perp shows that the restriction of L to M^\perp is self adjoint, and this restriction is certainly bounded and compact. Arguing by contradiction, suppose $M^\perp \neq 0$. Then either $L = 0$ or else $L \neq 0$ and the main step above shows that L has an eigenvector in M^\perp . Thus L has an eigenvector v_0 of norm 1 in M^\perp in either case. But then $S \cup \{v_0\}$ would be an orthonormal system of eigenvectors properly containing S , in contradiction to the maximality. We conclude that $M^\perp = 0$. Since M is a closed vector subspace of H , it satisfies $M^{\perp\perp} = M$. Therefore $M = (M^\perp)^\perp = 0^\perp = H$, and H has an orthonormal basis of eigenvectors.

With the orthonormal basis $S = \{v_\alpha\}$ of eigenvectors fixed, consider all v_α 's for which the corresponding eigenvalue λ_α has $|\lambda_\alpha| \geq \epsilon$. If α_1 and α_2 are two distinct such indices, we have

$$\begin{aligned} \|L(v_{\alpha_1}) - L(v_{\alpha_2})\|^2 &= \|\lambda_{\alpha_1} v_{\alpha_1} - \lambda_{\alpha_2} v_{\alpha_2}\|^2 \\ &= \|\lambda_{\alpha_1} v_{\alpha_1}\|^2 + \|\lambda_{\alpha_2} v_{\alpha_2}\|^2 \quad \text{by the Pythagorean theorem} \\ &= |\lambda_{\alpha_1}|^2 + |\lambda_{\alpha_2}|^2 \\ &\geq 2\epsilon^2. \end{aligned}$$

If there were infinitely many such eigenvectors v_{α_n} , the bounded sequence $\{L(v_{\alpha_n})\}$ could not have a convergent subsequence, in contradiction to compactness. Thus only finitely many members of S have eigenvalue with absolute value $\geq \epsilon$.

Fix $\lambda \neq 0$, let S_λ be the finite set of members of S with eigenvalue λ , and let H_λ be the linear span of S_λ . If v is an eigenvector of L for the eigenvalue λ beyond the vectors in H_λ , then the expansion

$$v = \sum_{v_\alpha \in S_\lambda} (v, v_\alpha) v_\alpha + \sum_{v_\alpha \in S - S_\lambda} (v, v_\alpha) v_\alpha$$

shows that $(v, v_\alpha) \neq 0$ for some v_α in $S - S_\lambda$. This v_α must have eigenvalue λ' different from λ , and then Proposition 2.2 gives the contradiction $(v, v_\alpha) = 0$. We conclude that H_λ is the entire eigenspace for eigenvalue λ and that the eigenvalues of the members of S are the only eigenvalues of L .

For each positive integer n , we know that only finitely many eigenvalues λ corresponding to members of S have $|\lambda| \geq 1/n$. Since every eigenvalue of L is the eigenvalue for some member of S , the number of eigenvalues λ of L with $|\lambda| \geq 1/n$ is finite. Taking the union of these sets as n varies, we see that the number of eigenvalues of L is countable. This completes the proof. \square

3. Hilbert–Schmidt Theorem

The Hilbert–Schmidt Theorem was postponed from Section I.3, where it was used in connection with Sturm–Liouville theory. The nub of the matter is the Spectral Theorem for compact self-adjoint operators on a Hilbert space, Theorem 2.3. But the actual result quoted in Section I.3 contains an overlay of measure theory and continuity. Correspondingly there is an abstract Hilbert–Schmidt Theorem, which combines the Spectral Theorem with the measure theory, and then there is a concrete form, which adds the hypothesis of continuity and obtains extra conclusions from it.

The abstract theorem works with an **integral operator** on L^2 of a σ -finite measure space (X, μ) , the operator being of the form

$$Tf(x) = \int_X K(x, y)f(y) d\mu(y),$$

where $K(x, y)$ is measurable on $X \times X$. The function K is called the **kernel** of the operator.³ If f is in $L^2(X, \mu)$, then the Schwarz inequality gives $|Tf(x)| \leq \|K(x, \cdot)\|_2 \|f\|_2$ for each x in X . Squaring both sides, integrating, and taking the square root yields $\|Tf\|_2 \leq \left(\int_{X \times X} |K|^2 d(\mu \times \mu)\right)^{1/2} \|f\|_2$. As a linear operator on $L^2(X, \mu)$, T therefore has operator norm satisfying

$$\|T\| \leq \left(\int_X \int_X |K(x, y)|^2 d\mu(x) d\mu(y)\right)^{1/2} = \|K\|_2.$$

In particular, T is bounded if K is square-integrable on $X \times X$. In this case the adjoint of T is given by

$$T^*g(x) = \int_X \overline{K(y, x)}g(y) d\mu(y)$$

because $(Tf, g) = \int_X \int_X K(x, y)f(y)\overline{g(x)} d\mu(y) d\mu(x)$ and because the asserted form of T^* has

$$\begin{aligned} (f, T^*g) &= \int_X f(x) \overline{\left(\int_X \overline{K(y, x)}g(y) d\mu(y)\right)} d\mu(x) \\ &= \int_X \int_X f(x)K(y, x)\overline{g(y)} d\mu(y) d\mu(x). \end{aligned}$$

³Not to be confused with the abstract-algebra notion of “kernel” as the set mapped to 0.

Theorem 2.4 (Hilbert–Schmidt Theorem, abstract form). Let (X, μ) be a σ -finite measure space, and let $K(\cdot, \cdot)$ be a complex-valued L^2 function on $X \times X$ such that $K(x, y) = \overline{K(y, x)}$ for all x and y in X . Then the linear operator T defined by

$$(Tf)(x) = \int_X K(x, y)f(y) d\mu(y)$$

is a self-adjoint compact operator on the Hilbert space $L^2(X, \mu)$ with $\|T\| \leq \|K\|_2$. Consequently if for each complex $\lambda \neq 0$, a vector subspace V_λ of $L^2(X, \mu)$ is defined by

$$V_\lambda = \{f \in L^2(X, \mu) \mid Tf = \lambda f\},$$

then each V_λ is finite dimensional, the space V_λ is nonzero for only countably many λ , the spaces V_λ are mutually orthogonal with respect to the inner product on $L^2(X, \mu)$, the λ 's with $V_\lambda \neq 0$ are all real, and for any $\epsilon > 0$, there are only finitely many λ with $V_\lambda \neq 0$ and $|\lambda| \geq \epsilon$. The largest value of $|\lambda|$ for which $V_\lambda \neq 0$ is $\|T\|$. Moreover, the vector subspace of L^2 orthogonal to all V_λ is the kernel of T , so that if v_1, v_2, \dots is an enumeration of the union of orthonormal bases of the spaces V_λ with $\lambda \neq 0$, then for any f in $L^2(X, \mu)$,

$$Tf = \sum_{n=1}^{\infty} (Tf, v_n)v_n,$$

the series on the right side being convergent in $L^2(X, \mu)$.

PROOF. Theorem 2.3 shows that it is enough to prove that the self-adjoint bounded linear operator T is compact. Choose a sequence of simple functions K_n square integrable on $X \times X$ such that $\lim_n \|K - K_n\|_2 = 0$, and define $T_n f(x) = \int_X K_n(x, y)f(y) d\mu(y)$. The linear operator T_n is bounded with $\|T_n\| \leq \|K_n\|_2$, and it has finite-dimensional image since K_n is simple. By Proposition 2.1a, T_n is compact. Since $\|T - T_n\| \leq \|K - K_n\|_2$ and since the right side tends to 0, T is exhibited as the limit of T_n in the operator norm and is compact by Proposition 2.1b. \square

Now we include the overlay of continuity. The additional assumptions are that X is a compact metric space, μ is a Borel measure on X that assigns positive measure to every nonempty open set, and K is continuous on $X \times X$. The additional conclusions are that the eigenfunctions for the nonzero eigenvalues are continuous and that the series expansion actually converges absolutely uniformly as well as in L^2 . The result used in Section I.3 was the special case of this result with $X = [a, b]$ and μ equal to Lebesgue measure.

Theorem 2.5 (Hilbert–Schmidt Theorem, concrete form). Let X be a compact metric space, let μ be a Borel measure on X that assigns positive measure to every nonempty open set, and let $K(\cdot, \cdot)$ be a complex-valued continuous function on $X \times X$ such that $K(x, y) = \overline{K(y, x)}$ for all x and y in X . Then the linear operator T defined by

$$Tf(x) = \int_X K(x, y)f(y) d\mu(y),$$

is a self-adjoint compact operator on the Hilbert space $L^2(X, \mu)$ with $\|T\| \leq \|K\|_2$, and its image lies in $C(X)$. Consequently the vector subspace V_λ of $L^2(X, \mu)$ defined for any complex $\lambda \neq 0$ by

$$V_\lambda = \{f \in L^2(X, \mu) \mid Tf = \lambda f\}$$

consists of continuous functions, each V_λ is finite dimensional, the space V_λ is nonzero for only countably many λ , the spaces V_λ are mutually orthogonal with respect to the inner product on $L^2(X, \mu)$, the λ 's with $V_\lambda \neq 0$ are all real, and for any $\epsilon > 0$, there are only finitely many λ with $V_\lambda \neq 0$ and $|\lambda| \geq \epsilon$. The largest value of $|\lambda|$ for which $V_\lambda \neq 0$ is $\|T\|$. If v_1, v_2, \dots is an enumeration of the union of orthonormal bases of the spaces V_λ with $\lambda \neq 0$, then for any f in $L^2(X, \mu)$,

$$Tf(x) = \sum_{n=1}^{\infty} (Tf, v_n)v_n(x),$$

the series on the right side being absolutely uniformly convergent for x in X .

REMARK. The hypothesis that μ assigns positive measure to every nonempty open set is used only to identify $\sum_{n=1}^{\infty} (Tf, v_n)v_n(x)$ with $Tf(x)$ at every point. Without this particular hypothesis on μ , the series is still absolutely uniformly convergent, but its sum is shown to equal $Tf(x)$ only almost everywhere with respect to μ .

PROOF. Given $\epsilon > 0$, choose $\delta > 0$ by uniform continuity of K such that $|K(x, y) - K(x_0, y_0)| \leq \epsilon$ whenever (x, y) and (x_0, y_0) are at distance $\leq \delta$. If f is in $L^2(X, \mu)$ and the points x and x_0 are at distance $\leq \delta$, then (x, y) and (x_0, y) are at distance $\leq \delta$ and hence

$$\begin{aligned} |Tf(x) - Tf(x_0)| &\leq \int_X |K(x, y) - K(x_0, y)| |f(y)| d\mu(y) \\ &\leq \epsilon \int_X |f(y)| d\mu(y) \leq \epsilon \|f\|_2 (\mu(X))^{1/2}, \end{aligned}$$

the last step following from the Schwarz inequality. This proves that Tf is continuous for each f in $L^2(X, \mu)$. In particular, if $Tf = \lambda f$ with $\lambda \neq 0$, then $f = T(\lambda^{-1}f)$ exhibits f as in the image of T and therefore as continuous.

Everything in the theorem now follows from Theorem 2.4 except for the absolute uniform convergence to $Tf(x)$ in the last sentence of the theorem.

For the absolute uniform convergence, let (\cdot, \cdot) denote the inner product in $L^2(X, \mu)$. We begin by considering the function $\overline{K(x, \cdot)}$ for fixed x . It satisfies

$$(\overline{K(x, \cdot)}, v_n) = \int_X \overline{K(x, y)} \overline{v_n(y)} d\mu(y) = \overline{(Tv_n)(x)} = \overline{\lambda_n v_n(x)}$$

if v_n is in V_{λ_n} , and Bessel's inequality gives

$$\sum_{n=1}^N |\lambda_n|^2 |v_n(x)|^2 \leq \int_X |K(x, y)|^2 d\mu(y) \leq \|K\|_{\text{sup}}^2 \mu(X) \quad (*)$$

for all N and x . Since the v_n form an orthonormal basis of V_0^\perp ,

$$\lim_{N \rightarrow \infty} \|Tg - \sum_{n=1}^N (Tg, v_n)v_n\|_2 = 0 \quad (**)$$

for all g in $L^2(X, \mu)$. Meanwhile, we have

$$(Tg, v_n)v_n(x) = (g, Tv_n)v_n(x) = \lambda_n(g, v_n)v_n(x).$$

Application of the Schwarz inequality and (*) gives

$$\begin{aligned} \sum_{n=M}^N |(Tg, v_n)v_n(x)| &= \sum_{n=M}^N |\lambda_n(g, v_n)v_n(x)| \\ &\leq \left(\sum_{n=M}^N |\lambda_n|^2 |v_n(x)|^2 \right)^{1/2} \left(\sum_{n=M}^N |(g, v_n)|^2 \right)^{1/2} \\ &\leq \|K\|_{\text{sup}} \mu(X)^{1/2} \left(\sum_{n=M}^N |(g, v_n)|^2 \right)^{1/2}. \end{aligned}$$

Bessel's inequality shows that the series $\sum_{n=1}^{\infty} |(g, v_n)|^2$ converges and has sum $\leq \|g\|_2^2$. Therefore $\sum_{n=M}^N |(g, v_n)|^2$ tends to 0 as M and N tend to infinity, and the rate is independent of x . Consequently the series $\sum_{n=1}^{\infty} |(Tg, v_n)v_n(x)|$ is uniformly Cauchy, and it follows that the series $\sum_{n=1}^{\infty} (Tg, v_n)v_n(x)$ is absolutely uniformly convergent for x in X . Since the uniform limit of continuous functions is continuous, the sum has to be a continuous function. Since (**) shows that $\sum_{n=1}^N (Tg, v_n)v_n$ converges in $L^2(X, \mu)$ to Tg , a subsequence of $\sum_{n=1}^N (Tg, v_n)v_n(x)$ converges almost everywhere to $Tg(x)$. Since Tg is continuous, the set where $\sum_{n=1}^{\infty} (Tg, v_n)v_n(x) \neq Tg(x)$ is an open set. The fact that this set has measure 0 implies, in view of the hypothesis on μ , that this set is empty. Thus $\sum_{n=1}^{\infty} (Tg, v_n)v_n(x)$ converges absolutely uniformly to $Tg(x)$. \square

4. Unitary Operators

In \mathbb{C}^N , a unitary matrix corresponds in the standard basis to a **unitary** linear transformation U , i.e., one with $U^* = U^{-1}$. Such a transformation preserves inner products and therefore carries any orthonormal basis to another orthonormal basis. Conversely any linear transformation from \mathbb{C}^N to itself that carries some orthonormal basis to another orthonormal basis is unitary. For the infinite-dimensional case we define a linear operator to be **unitary** if it satisfies the equivalent conditions in the following proposition.⁴

Proposition 2.6. If V is a real or complex Hilbert space, then the following conditions on a linear operator $U : V \rightarrow V$ are equivalent:

- (a) $UU^* = U^*U = 1$,
- (b) U is onto V , and $(Uv, Uv') = (v, v')$ for all v and v' in V ,
- (c) U is onto V , and $\|Uv\| = \|v\|$ for all v in V .

A unitary operator carries any orthonormal basis to an orthonormal basis. Conversely if $\{u_i\}$ and $\{v_i\}$ are orthonormal bases, then there exists a unique bounded linear operator U such that $Uu_i = v_i$ for all i , and U is unitary.

REMARKS. In the finite-dimensional case the condition “ $UU^* = 1$ ” in (a) and the condition “ U is onto V ” in (b) and (c) follow from the rest, but that implication fails in the infinite-dimensional case. Any two orthonormal bases have the same cardinality, by Proposition 12.11 of *Basic*, and hence the index sets for $\{u_i\}$ and $\{v_i\}$ in the statement of the proposition may be taken to be the same.

PROOF. If (a) holds, then $UU^* = 1$ proves that U is onto, and $U^*U = 1$ proves that $(Uv, Uv') = (U^*Uv, v') = (v, v')$. Thus (b) holds. In the reverse direction, suppose that (b) holds. From $(U^*Uv, v') = (Uv, Uv') = (v, v')$ for all v and v' , we see that $U^*U = 1$. Thus U is one-one. Since U is assumed onto, it has a two-sided inverse, which must then equal U^* since any left inverse equals any right inverse. Thus (a) holds, and (a) and (b) are equivalent. Conditions (b) and (c) are equivalent by polarization.

If $\{u_i\}$ is an orthonormal basis and U is unitary, then $(Uu_i, Uu_j) = (u_i, u_j) = \delta_{ij}$ by (b), and hence $\{Uu_i\}$ is an orthonormal set. If $(v, Uu_i) = 0$ for all i , then $(U^*v, u_i) = 0$ for all i , $U^*v = 0$, and $v = U(U^*v) = U0 = 0$. So $\{Uu_i\}$ is an orthonormal basis.

If $\{u_i\}$ and $\{v_i\}$ are orthonormal bases, define U on finite linear combinations of the u_i by $U(\sum_i c_i u_i) = \sum_i c_i v_i$. Then $\|U(\sum_i c_i u_i)\|^2 = \|\sum_i c_i v_i\|^2 =$

⁴This book uses the term “unitary” for both real and complex Hilbert spaces. A unitary linear operator from a *real* Hilbert space into itself is traditionally said to be **orthogonal**, but there is no need to reject the word “unitary” for real Hilbert spaces.

$\sum_i |c_i|^2 = \|\sum_i c_i u_i\|^2$. Hence U extends to a bounded linear operator on V , necessarily preserving norms. It must be onto V since it preserves norms and its image contains the dense set of finite linear combinations $\sum_i c_i v_i$. Thus (c) holds, and U is unitary. \square

Since unitary operators are exactly the invertible linear operators that preserve inner products, they are the ones that serve as isomorphisms of a Hilbert space with itself. Theorem 2.3 and Proposition 2.6 together give us a criterion for deciding whether two compact self-adjoint operators on a Hilbert space are related to each other by an underlying isomorphism of the Hilbert space: the criterion is that the two operators have the same eigenvalues, that the dimension of the eigenspace for each nonzero eigenvalue of one operator match the dimension of the eigenspace for that eigenvalue of the other operator, and that the Hilbert-space dimension of the zero eigenspaces of the two operators match.

5. Classes of Compact Operators

In this section we bring together various threads concerning compact operators, integral operators, the Hilbert–Schmidt Theorem, the Hilbert–Schmidt norm of a square matrix, and traces of matrices. The end product is to consist of some relationships among these notions, together with the handy notion of the trace of an operator. Once we have multiple Fourier series available as a tool in the next chapter, we will be able to supplement the results of the present section and obtain a formula for computing the trace of certain kinds of integral operators. Let us start with various notions about bounded linear operators from an abstract real or complex Hilbert space V to itself, touching base with familiar notions when $V = \mathbb{C}^n$.

Compact linear operators were discussed in Section 1. Compactness means that the image of the closed unit ball has compact closure in V . We know from Proposition 2.1 that the compact linear operators are exactly those that can be approximated in the operator norm topology by linear operators with finite-dimensional image. The adjoint of a compact linear operator is compact. Being the members of the closure of a vector subspace, the compact linear operators form a vector subspace. When $V = \mathbb{C}^n$, every linear operator is of course compact.

If L is a compact linear operator, then LA and AL are compact whenever A is a bounded linear operator. In fact, if L_n is a sequence of linear operators with finite-dimensional image such that $\|L - L_n\| \rightarrow 0$, then $\|LA - L_n A\| \leq \|L - L_n\| \|A\| \rightarrow 0$; since $L_n A$ has finite-dimensional image, LA is compact. To see that AL is compact, we take the adjoint: L^* is compact, and hence $L^* A^* = (AL)^*$ is compact; since $(AL)^*$ is compact, so is AL . In algebraic

terminology the compact linear operators form a two-sided ideal in the algebra of all bounded linear operators.

Next we introduce Hilbert–Schmidt operators. If L is a bounded linear operator on V and if $\{u_i\}$ and $\{v_j\}$ are orthonormal bases of V , then Parseval’s equality gives

$$\begin{aligned}\sum_i \|Lu_i\|^2 &= \sum_{i,j} |(Lu_i, v_j)|^2 = \sum_{i,j} |(u_i, L^*v_j)|^2 \\ &= \sum_{i,j} |\overline{(L^*v_j, u_i)}|^2 = \sum_{i,j} |(L^*v_j, u_i)|^2 = \sum_j \|L^*v_j\|^2.\end{aligned}$$

Application of this formula twice shows that if we replace $\{u_i\}$ by a different orthonormal basis $\{u'_i\}$, we get $\sum_i \|Lu_i\|^2 = \sum_i \|Lu'_i\|^2$. The expression

$$\|L\|_{\text{HS}}^2 = \sum_i \|Lu_i\|^2 = \sum_{i,j} |(Lu_i, v_j)|^2,$$

which we therefore know to be independent of both orthonormal bases $\{u_i\}$ and $\{v_j\}$, is the square of what is called the **Hilbert–Schmidt norm** $\|L\|_{\text{HS}}$ of L .

For the finite-dimensional situation in which the underlying Hilbert space is \mathbb{R}^n or \mathbb{C}^n , we can take $\{u_i\}$ and $\{v_j\}$ both to be the standard orthonormal basis, and then the Hilbert–Schmidt norm of the linear function corresponding to a matrix A is just $(\sum_{i,j} |A_{ij}|^2)^{1/2}$.

Our computation with $\|L\|_{\text{HS}}$ above shows that

$$\|L\|_{\text{HS}} = \|L^*\|_{\text{HS}}.$$

The bounded linear operators that have finite Hilbert–Schmidt norm are called **Hilbert–Schmidt operators**. The name results from the following proposition.

Proposition 2.7. Let (X, μ) be a σ -finite measure space such that $L^2(X, \mu)$ is separable, and let $K(\cdot, \cdot)$ be a complex-valued L^2 function on $X \times X$. Then the linear operator T defined by

$$(Tf)(x) = \int_X K(x, y)f(y) d\mu(y)$$

is a compact operator on the Hilbert space $L^2(X, \mu)$ with $\|T\|_{\text{HS}} = \|K\|_2$.

REMARK. No self-adjointness is assumed in this proposition.

PROOF. If $\{u_i\}$ is an orthonormal basis of $L^2(X, \mu)$, then the functions $(u_j \otimes \bar{u}_i)(x, y) = u_j(x)\overline{u_i(y)}$ form an orthonormal basis of $L^2(X \times X, \mu \times \mu)$ as a consequence of Proposition 12.9 of *Basic*. Hence

$$(Tu_i, u_j) = \int_X \int_X K(x, y)u_i(y)\overline{u_j(x)} d\mu(x) d\mu(y) = (K, (u_j \otimes \bar{u}_i)).$$

Taking the square of the absolute value of both sides and summing on i and j , we obtain $\|T\|_{\text{HS}}^2 = \|K\|_2^2$. \square

Returning to an abstract Hilbert space V and the bounded linear operators on it, let us observe for any L that

$$\|L\| \leq \|L\|_{\text{HS}}.$$

In fact, if u in V has $\|u\| = 1$, then the singleton set $\{u\}$ can be extended to an orthonormal basis $\{u_i\}$, and we obtain $\|Lu\|^2 \leq \sum_i \|Lu_i\|^2 = \|L\|_{\text{HS}}^2$. Taking the supremum over u with $\|u\| = 1$, we see that $\|L\|^2 \leq \|L\|_{\text{HS}}^2$. Two easier but related inequalities are that

$$\|AL\|_{\text{HS}} \leq \|A\| \|L\|_{\text{HS}} \quad \text{and} \quad \|LA\|_{\text{HS}} \leq \|A\| \|L\|_{\text{HS}}.$$

The first of these follows from the inequality $\|ALu_i\|^2 \leq \|A\|^2 \|Lu_i\|^2$ by summing over an orthonormal basis. The second follows from the first because $\|LA\|_{\text{HS}} = \|(LA)^*\|_{\text{HS}} = \|A^*L^*\|_{\text{HS}} \leq \|A^*\| \|L^*\|_{\text{HS}} = \|A\| \|L\|_{\text{HS}}$.

Any Hilbert–Schmidt operator is compact. In fact, if L is Hilbert–Schmidt, let $\{u_i\}$ be an orthonormal basis, let $\epsilon > 0$ be given, and choose a finite set F of indices i such that $\sum_{i \notin F} \|Lu_i\|^2 < \epsilon$. If E is the orthogonal projection on the span of the u_i for i in F , then we obtain $\|L^* - EL^*\|^2 = \|L - LE\|^2 \leq \|L - LE\|_{\text{HS}}^2 = \sum_i \|(L - LE)u_i\|^2 < \epsilon$. Hence L^* can be approximated in the operator norm topology by operators with finite-dimensional image and is compact; since L^* is compact, L is compact.

The sum of two Hilbert–Schmidt operators is Hilbert–Schmidt. In fact, we have $\|(L + M)u_i\| \leq \|Lu_i\| + \|Mu_i\| \leq 2 \max\{\|Lu_i\|, \|Mu_i\|\}$. Squaring gives $\|(L + M)u_i\|^2 \leq 4 \max\{\|Lu_i\|^2, \|Mu_i\|^2\} \leq 4(\|Lu_i\|^2 + \|Mu_i\|^2)$, and the result follows when we sum on i . Thus the Hilbert–Schmidt operators form a vector subspace of the bounded linear operators on V , in fact a vector subspace of the compact operators on V . As is true of the compact operators, the Hilbert–Schmidt operators form a two-sided ideal in the algebra of all bounded linear operators; this fact follows from the inequalities $\|AL\|_{\text{HS}} \leq \|A\| \|L\|_{\text{HS}}$ and $\|LA\|_{\text{HS}} \leq \|A\| \|L\|_{\text{HS}}$.

The vector space of Hilbert–Schmidt operators becomes a normed linear space under the Hilbert–Schmidt norm. Even more, it is an inner-product space. To see this, let L and M be Hilbert–Schmidt operators, and let $\{u_i\}$ be an orthonormal basis. We define $\langle L, M \rangle = \sum_i (Lu_i, Mu_i)$. This sum is absolutely convergent as we see from two applications of the Schwarz inequality: $\sum_i |(Lu_i, Mu_i)| \leq \sum_i \|Lu_i\| \|Mu_i\| \leq (\sum_i \|Lu_i\|^2)^{1/2} (\sum_i \|Mu_i\|^2)^{1/2} = \|L\|_{\text{HS}} \|M\|_{\text{HS}} < \infty$. Substituting from the definitions, we readily check that

$$\langle L, M \rangle = \begin{cases} \sum_{k \in \{0,2\}} \frac{i^k}{4} \|L + i^k M\|_{\text{HS}}^2 & \text{if } V \text{ is real,} \\ \sum_{k=0}^3 \frac{i^k}{4} \|L + i^k M\|_{\text{HS}}^2 & \text{if } V \text{ is complex.} \end{cases}$$

Hence the definition of $\langle L, M \rangle$ is independent of the orthonormal basis. It is immediate from the definition and the above convergence that the form $\langle \cdot, \cdot \rangle$ makes the vector space of Hilbert–Schmidt operators into an inner-product space with associated norm $\| \cdot \|_{\text{HS}}$.

If L has finite-dimensional image, then L is a Hilbert–Schmidt operator. In fact, let E be the orthogonal projection on image L , take an orthonormal basis $\{u_i \mid i \in F\}$ of image L , and extend to an orthonormal basis $\{u_i \mid i \in S\}$ of V ; here F is a finite subset of S . Then $\sum_{i \in S} \|Lu_i\|^2 = \sum_{i \in S} \|ELu_i\|^2 = \sum_{i \in S} \|L^*Eu_i\|^2 = \sum_{i \in F} \|L^*u_i\|^2 < \infty$. Thus the Hilbert–Schmidt operators form an ideal between the ideal of compact operators and the ideal of operators with finite-dimensional image.

Now we turn to a generalization of the trace $\text{Tr } A = \sum_i A_{ii}$ of a square matrix A . This generalization plays a basic role in distribution theory, in index theory for partial differential equations, and in representation theory. In this section we shall describe the operators, and at the end of Chapter III we shall show how traces can be computed for simple integral operators. Realistic applications tend to be beyond the scope of this book.

Although the trace of a linear operator on \mathbb{C}^n may be computed as the sum of the diagonal entries of the matrix of the operator in any basis, we shall continue to use orthonormal bases. Thus the expression we seek to extend to any Hilbert space V is $\sum_i (Lu_i, u_i)$. The operators of “trace class” are to be a subset of the Hilbert–Schmidt operators. It might at first appear that the condition to impose for the definition of trace class is that $\sum_i (Lu_i, u_i)$ be absolutely convergent for some orthonormal basis, but this condition is not enough. In fact, if a bounded linear operator L is defined on a Hilbert space with orthonormal basis u_1, u_2, \dots by $Lu_i = u_{i+1}$ for all i , then $(Lu_i, u_i) = 0$ for all i ; on the other hand, $\|Lu_i\|^2 = 1$ for all i , and L is not Hilbert–Schmidt.

We say that a bounded linear operator L on V is of **trace class** if it is a compact operator⁵ such that $\sum_i |(Lu_i, v_i)| < \infty$ for all orthonormal bases $\{u_i\}$ and $\{v_i\}$. Since compact operators are closed under addition and under passage to adjoints, we see directly from the definition that the sum of two trace-class operators is of trace class and that the adjoint of a trace-class operator is of trace class. The operator $L = B^*A$ with A and B Hilbert–Schmidt is an example of a trace-class operator. In fact, the operator L is compact as the product of two compact operators; also, $(Lu_i, v_i) = (B^*Au_i, v_i) = (Au_i, Bv_i)$, and we therefore have $\sum_i |(Lu_i, v_i)| = \sum_i |(Au_i, Bv_i)| \leq \sum_i \|Au_i\| \|Bv_i\| \leq$

⁵This condition is redundant; it is enough to assume boundedness. However, to proceed without using compactness of L , we would have to know that L^*L has a “positive semidefinite” square root, which requires having the full Spectral Theorem for bounded self-adjoint operators. This theorem is not available until the end of Chapter IV. The development here instead gets by with the Spectral Theorem for compact self-adjoint operators (Theorem 2.3).

$(\sum_i \|Au_i\|^2)^{1/2}(\sum_i \|Bv_i\|^2)^{1/2} = \|A\|_{\text{HS}}\|B\|_{\text{HS}}$. The following proposition shows that there are no other examples.

Proposition 2.8. If $L : V \rightarrow V$ is a trace-class operator on the Hilbert space V , then L factors as $L = B^*A$ with A and B Hilbert–Schmidt. Moreover, the supremum of $\sum_i |(Lu_i, v_i)|$ over all orthonormal bases $\{u_i\}$ and $\{v_i\}$ equals the infimum, over all Hilbert–Schmidt A and B such that $L = B^*A$, of the product $\|A\|_{\text{HS}}\|B\|_{\text{HS}}$.

PROOF. First we produce a factorization. Since L is a compact operator, L^*L is a compact self-adjoint operator, and Theorem 2.3 shows that L^*L has an orthonormal basis of eigenvectors w_i with real eigenvalues λ_i tending to 0. Since $\lambda_i(w_i, w_i) = (L^*Lw_i, w_i) = (Lw_i, Lw_i)$, we see that all λ_i are ≥ 0 . Define a bounded linear operator T by $Tw_i = \sqrt{\lambda_i}w_i$ for all i . The operator T is self-adjoint, it has $(Tv, v) \geq 0$ for all v , its kernel N is the smallest closed vector subspace containing all the w_i with $\lambda_i = 0$, and its image is dense in N^\perp . Since $N \cap N^\perp = 0$, T is one-one from N^\perp into N^\perp . Thus $Tv \mapsto Lv$ is a well-defined linear function from a dense vector subspace of N^\perp into V . The map $Tv \mapsto Lv$ has the property that $\|Lv\|^2 = (Lv, Lv) = (L^*Lv, v) = (T^2v, v) = (Tv, Tv) = \|Tv\|^2$. Thus $Tv \mapsto Lv$ is a linear isometry from a dense vector subspace of N^\perp into V . Since V is complete, $Tv \mapsto Lv$ extends to a linear isometry $U : N^\perp \rightarrow V$. This U satisfies $L = UT$.

Let I be the set of indices i for the orthonormal basis $\{w_i\}$, and let P be the subset with $\lambda_i > 0$. By polarization, U preserves inner products in carrying N^\perp into V . Extend U to all of V by setting it equal to 0 on N , so that U^* is well defined. The system $\{w_i\}_{i \in P}$ is an orthonormal basis of N^\perp , and hence the system $\{f_i\}_{i \in P}$ with $f_i = Uw_i$ for $i \in P$ is an orthonormal set in V . Since $U : N^\perp \rightarrow V$ is isometric, we have $(w_i, U^*f_i) = (Uw_i, f_i) = (Uw_i, Uw_i) = (w_i, w_i)$. Since Tw_i is a multiple of w_i , we obtain $(Tw_i, U^*f_i) = (Tw_i, w_i)$. Therefore

$$\begin{aligned} \sum_{i \in P} |(Lw_i, f_i)| &= \sum_{i \in P} |(UTw_i, f_i)| = \sum_{i \in P} |(Tw_i, U^*f_i)| \\ &= \sum_{i \in P} |(Tw_i, w_i)| = \sum_{i \in P} (Tw_i, w_i). \end{aligned}$$

Extend $\{f_i\}_{i \in P}$ to an orthonormal basis $\{f_i\}$ of V ; since any two orthonormal bases of a Hilbert space have the same cardinality, we can index the new vectors of this set by $I - P$. The operators L and T have the same kernel, and thus the sums for $i \in P$ can be extended over all i in I to give

$$\sum_{i \in I} |(Lw_i, f_i)| = \sum_{i \in I} (Tw_i, w_i).$$

Define a bounded linear operator S on V by $Sw_i = \sqrt[4]{\lambda_i}w_i$ for all i . Then $|(Sw_i, w_j)|^2 = \delta_{ij}(S^2w_i, w_i) = \delta_{ij}(Tw_i, w_i)$, and hence S is a Hilbert–Schmidt

operator with $\|S\|_{\text{HS}}^2 = \sum_{i \in I} (Tw_i, w_i)$. Take $A = S$ and $B^* = US$; each of these is Hilbert–Schmidt since $\|US\|_{\text{HS}} \leq \|U\| \|S\|_{\text{HS}}$, and we have $B^*A = USS = UT = L$. This proves the existence of a decomposition $B^*A = L$.

For the bases $\{w_i\}$ and $\{f_i\}$, we have just seen that

$$\|A\|_{\text{HS}} \|B\|_{\text{HS}} \leq \|S\|_{\text{HS}} \|U\| \|S\|_{\text{HS}} \leq \|S\|_{\text{HS}}^2 = \sum_{i \in I} (Tw_i, w_i) = \sum_{i \in I} |(Lw_i, f_i)|.$$

But if $L = B'^*A'$ is any decomposition of L as the product of Hilbert–Schmidt operators and if $\{u_i\}$ and $\{v_i\}$ are any two orthonormal bases, we have

$$\begin{aligned} \sum_i |(Lu_i, v_i)| &= \sum_i |(B'^*A'u_i, v_i)| = \sum_i |(A'u_i, B'v_i)| \\ &\leq \sum_i \|A'u_i\| \|B'v_i\| \leq \|A'\|_{\text{HS}} \|B'\|_{\text{HS}}. \end{aligned}$$

Therefore $\sup \sum_i |(Lu_i, v_i)| \leq \inf \|A'\|_{\text{HS}} \|B'\|_{\text{HS}}$,

as asserted. \square

If $\{u_i\}$ is an orthonormal basis of V and L is of trace class, we can thus write $L = B^*A$ with A and B Hilbert–Schmidt. We define the **trace** of L to be

$$\text{Tr } L = \sum_i (Lu_i, u_i) = \sum_i (B^*Au_i, u_i) = \sum_i (Au_i, Bu_i) = \langle A, B \rangle.$$

The series $\sum_i (Lu_i, u_i)$ is absolutely convergent by definition of trace class. The trace of L is independent of the orthonormal basis since it equals $\langle A, B \rangle$, and it is independent of A and B since it equals $\sum_i (Lu_i, u_i)$.

In practice it is not so easy to check from the definition that L is of trace class. But there is a simple sufficient condition.

Proposition 2.9. If $L : V \rightarrow V$ is a bounded linear operator on the Hilbert space V and if $\sum_{i,j} |(Lu_i, v_j)| < \infty$ for some orthonormal bases $\{u_i\}$ and $\{v_j\}$, then L is of trace class.

PROOF. Since $|(Lu_i, v_i)| \leq \|L\|$, we have $|(Lu_i, v_j)|^2 \leq \|L\| |(Lu_i, v_j)|$ for all i and j , and it follows from the finiteness of $\sum_{i,j} |(Lu_i, v_j)|$ that $\|L\|_{\text{HS}}^2 = \sum_{i,j} |(Lu_i, v_j)|^2$ is finite. Thus L is a Hilbert–Schmidt operator and has to be compact.

If $\{e_k\}$ and $\{f_l\}$ are orthonormal bases, we expand $e_k = \sum_i (e_k, u_i)u_i$ and $f_k = \sum_j (f_k, v_j)v_j$ and substitute to obtain $(Le_k, f_k) = \sum_{i,j} (e_k, u_i)(Lu_i, v_j)\overline{(f_k, v_j)}$. Taking the absolute value and summing on k gives

$$\sum_k |(Le_k, f_k)| \leq \sum_{i,j} |(Lu_i, v_j)| \sum_k |(e_k, u_i)\overline{(f_k, v_j)}|.$$

Application of the Schwarz inequality to the sum on k and then Bessel's inequality to each factor of the result yields

$$\begin{aligned} \sum_k |(Le_k, f_k)| &\leq \sum_{i,j} |(Lu_i, v_j)| \left(\sum_k |(e_k, u_i)|^2 \right)^{1/2} \left(\sum_k |(f_k, v_j)|^2 \right)^{1/2} \\ &\leq \sum_{i,j} |(Lu_i, v_j)| \|u_i\| \|v_j\| = \sum_{i,j} |(Lu_i, v_j)| < \infty, \end{aligned}$$

and therefore L is of trace class. \square

6. Problems

1. Let (S, μ) be a σ -finite measure space, let f be in $L^\infty(S, \mu)$, and let M_f be the bounded linear operator on $L^2(S, \mu)$ given by $M_f(g) = fg$.
 - (a) Find a necessary and sufficient condition for M_f to have an eigenvector.
 - (b) Find a necessary and sufficient condition for M_f to be compact.
2. Let L be a compact operator on a Hilbert space, and let λ be a nonzero complex number. Prove that if $\lambda I - L$ is one-one, then the image of $\lambda I - L$ is closed.
3. Prove for a Hilbert space V that the normed linear space of Hilbert-Schmidt operators with the norm $\|\cdot\|_{\text{HS}}$ is a Banach space.
4. If L is a trace-class operator on a Hilbert space V , let $\|L\|_{\text{TC}}$ equal the supremum of $\sum_i |(Lu_i, v_i)|$ over all orthonormal bases $\{u_i\}$ and $\{v_i\}$. By Proposition 2.8 this equals the infimum, over all Hilbert-Schmidt A and B such that $L = B^*A$, of the product $\|A\|_{\text{HS}}\|B\|_{\text{HS}}$. Prove that the vector space of trace-class operators is a normed linear space under $\|\cdot\|_{\text{TC}}$ as norm.
5. If L is a trace-class operator on a complex Hilbert space V and A is a bounded linear operator, prove that $\text{Tr } AL = \text{Tr } LA$ and conclude that $\text{Tr}(BLB^{-1}) = \text{Tr } L$ for any bounded linear operator B .

Problems 6–8 deal with some extensions of Theorem 2.3 to situations involving several operators. A bounded linear operator L is said to be **normal** if $LL^* = L^*L$.

6. Suppose that $\{L_\alpha\}$ is a finite commuting family of compact self-adjoint operators on a Hilbert space. Prove that there exists an orthonormal basis consisting of simultaneous eigenvectors for all L_α .
7. Fix a *complex* Hilbert space V .
 - (a) Prove that the decomposition $L = \frac{1}{2}(L + L^*) + i\frac{1}{2i}(L - L^*)$ exhibits any normal operator $L : V \rightarrow V$ as a linear combination of commuting self-adjoint operators.
 - (b) Prove that the operators in (a) are compact if L is compact.
 - (c) State an extension of Theorem 2.3 that concerns compact normal operators on a complex Hilbert space.

8. Fix a Hilbert space V .
- Prove that a unitary operator from V to itself is always normal.
 - Under what circumstances is a unitary operator compact?

Problems 9–13 indicate an approach to second-order ordinary differential equations by integral equations in a way that predates the use of the Hilbert–Schmidt Theorem.

9. For $\omega \neq 0$, show that the unique solution $u(t)$ on $[a, b]$ of the equation $u'' + \omega^2 u = g(t)$ and the initial conditions $u(a) = 1$ and $u'(a) = 0$ is

$$u(t) = \cos \omega(t - a) + \omega^{-1} \int_a^t g(s) \sin \omega(t - s) ds.$$

10. Let $\rho(t)$ be a continuous function on $[a, b]$, and let $u(t)$ be the unique solution of the equation $u'' + [\omega^2 - \rho(t)]u = 0$ and the initial conditions $u(a) = 1$ and $u'(a) = 0$. Show that u satisfies the integral equation

$$u(t) - \omega^{-1} \int_a^t \rho(s) \sin \omega(t - s) u(s) ds = \cos \omega(t - a),$$

which is of the form $u(t) - \int_a^t K(t, s)u(s) ds = f(t)$, where $K(t, s)$ is continuous on the triangle $a \leq s \leq t \leq b$.

11. Let $K(t, s)$ be continuous on the triangle $a \leq s \leq t \leq b$. For f continuous on $[a, b]$, define $(Tf)(t) = \int_a^t K(t, s)f(s) ds$.
- Prove that f continuous implies Tf continuous.
 - Put $M = \max |K(t, s)|$. If f has $C = \int_a^b |f(t)| dt$, prove inductively that $|(T^n f)(t)| \leq \frac{CM^n}{(n-1)!} (t-a)^{n-1}$ for $n \geq 1$.
 - Deduce that the series $f + Tf + T^2 f + \dots$ converges uniformly on $[a, b]$.
12. Set $u = f + Tf + T^2 f + \dots$ in the previous problem, and prove that u satisfies $u - Tu = f$.
13. In the previous problem prove that $u = f + Tf + T^2 f + \dots$ is the only solution of $u - Tu = f$.

CHAPTER III

Topics in Euclidean Fourier Analysis

Abstract. This chapter takes up several independent topics in Euclidean Fourier analysis, all having some bearing on the subject of partial differential equations.

Section 1 elaborates on the relationship between the Fourier transform and the Schwartz space, the subspace of $L^1(\mathbb{R}^N)$ consisting of smooth functions with the property that the product of any iterated partial derivative of the function with any polynomial is bounded. It is possible to make the Schwartz space into a metric space, and then one can consider the space of continuous linear functionals; these continuous linear functionals are called “tempered distributions.” The Fourier transform carries the space of tempered distributions in one-one fashion onto itself.

Section 2 concerns weak derivatives, and the main result is Sobolev’s Theorem, which tells how to recover information about ordinary derivatives from information about weak derivatives. Weak derivatives are easy to manipulate, and Sobolev’s Theorem is therefore a helpful tool for handling derivatives without continually having to check the validity of interchanges of limits.

Sections 3–4 concern harmonic functions, those functions on open sets in Euclidean space that are annihilated by the Laplacian. The main results of Section 3 are a characterization of harmonic functions in terms of a mean-value property, a reflection principle that allows the extension to all of Euclidean space of any harmonic function in a half space that vanishes at the boundary, and a result of Liouville that the only bounded harmonic functions in all of Euclidean space are the constants. The main result of Section 4 is a converse to properties of Poisson integrals for half spaces, showing that harmonic functions in a half space are given as Poisson integrals of functions or of finite complex measures if their L^p norms over translates of the bounding Euclidean space are bounded.

Sections 5–6 concern the Calderón–Zygmund Theorem, a far-reaching generalization of the theorem concerning the boundedness of the Hilbert transform. Section 5 gives the statement and proof, and two applications are the subject of Section 6. One of the applications is to Riesz transforms, and the other is to the Beltrami equation, whose solutions are “quasiconformal mappings.”

Sections 7–8 concern multiple Fourier series for smooth periodic functions. The theory is established in Section 7, and an application to traces of integral operators is given in Section 8.

1. Tempered Distributions

We fix normalizations for the Euclidean Fourier transform as in *Basic*: For f in $L^1(\mathbb{R}^N)$, the definition is

$$\widehat{f}(y) = (\mathcal{F}f)(y) = \int_{\mathbb{R}^N} f(x)e^{-2\pi i x \cdot y} dx,$$

with $x \cdot y$ referring to the dot product and with the 2π in the exponent. The inversion formula is valid whenever \widehat{f} is in L^1 ; it says that f is recovered as

$$f(x) = (\mathcal{F}^{-1}\widehat{f})(x) = \int_{\mathbb{R}^N} \widehat{f}(y)e^{2\pi i x \cdot y} dy$$

almost everywhere, including at all points of continuity of f . The operator \mathcal{F} carries $L^1 \cap L^2$ into L^2 and extends to a linear map \mathcal{F} of L^2 onto L^2 such that $\|\mathcal{F}f\|_2 = \|f\|_2$. This is the Plancherel formula.

The Schwartz space $\mathcal{S} = \mathcal{S}(\mathbb{R}^N)$ is the vector space of all functions f in $C^\infty(\mathbb{R}^N)$ such that the product of any polynomial by any iterated partial derivative of f is bounded. This is a vector subspace of $L^1 \cap L^2$, and it was shown in *Basic* that \mathcal{F} carries \mathcal{S} one-one onto itself. It will be handy sometimes to use a notation for partial derivatives and their iterates that is different from that in Chapter I.

Namely,¹ let $D_j = \frac{\partial}{\partial x_j}$. If $\alpha = (\alpha_1, \dots, \alpha_N)$ is an N -tuple of nonnegative integers, we write $|\alpha| = \sum_{j=1}^N \alpha_j$, $\alpha! = \alpha_1! \cdots \alpha_N!$, $x^\alpha = x_1^{\alpha_1} \cdots x_N^{\alpha_N}$, and $D^\alpha = D_1^{\alpha_1} \cdots D_N^{\alpha_N}$. Addition of such tuples α is defined component by component, and we say that $\alpha \leq \beta$ if $\alpha_j \leq \beta_j$ for $1 \leq j \leq N$. We write $|\alpha|$ for the total order $\alpha_1 + \cdots + \alpha_N$, and we call α a **multi-index**. If $Q(x) = \sum_\alpha a_\alpha x^\alpha$ is a complex-valued polynomial on \mathbb{R}^N , define $Q(D)$ to be the partial differential operator $\sum_\alpha a_\alpha D^\alpha$ with constant coefficients obtained by substituting, for each j with $1 \leq j \leq N$, the operator $D_j = \frac{\partial}{\partial x_j}$ for x_j . The Schwartz functions are then the smooth functions f on \mathbb{R}^N such that $P(x)Q(D)f$ is bounded for each pair of polynomials P and Q .

The Schwartz space is directly usable in connection with certain linear partial differential equations with constant coefficients. A really simple example concerns the Laplacian operator $\Delta = \frac{\partial^2}{\partial x_1^2} + \cdots + \frac{\partial^2}{\partial x_N^2}$, which we can write as $\Delta = |D|^2$ in the new notation for differential operators. Specifically the equation

$$(1 - \Delta)u = f$$

has a unique solution u in \mathcal{S} for each f in \mathcal{S} . To see this, we take the Fourier transform of both sides, obtaining $\mathcal{F}u - \mathcal{F}(\Delta u) = \mathcal{F}f$ or $\mathcal{F}u - \mathcal{F}(|D|^2(u)) = \mathcal{F}f$. Using the formulas relating the Fourier transform, multiplication by polynomials, and differentiation,² we can rewrite this equation as $(1 + 4\pi^2|y|^2)\mathcal{F}(u) = \mathcal{F}(f)$. Problem 1 at the end of the chapter asks one to check that $(1 + 4\pi^2|y|^2)^{-1}g$ is in \mathcal{S} if

¹Some authors prefer to abbreviate $\frac{\partial}{\partial x_j}$ as ∂_j , reserving the notation D_j for the product of ∂_j and a certain imaginary scalar that depends on the definition of the Fourier transform.

²These, with hypotheses in place, appear as Proposition 8.1 of *Basic*.

g is in \mathcal{S} , and then existence of a solution in \mathcal{S} to the differential equation is proved by the formula $u = \mathcal{F}^{-1}((1 + 4\pi^2|y|^2)^{-1}\mathcal{F}(f))$. For uniqueness let u_1 and u_2 be two solutions in \mathcal{S} corresponding to the same f . Then $(1 - \Delta)(u_1 - u_2) = 0$, and hence $(1 + 4\pi^2|y|^2)\mathcal{F}(u_1 - u_2)(y) = 0$ for all y . Therefore $\mathcal{F}(u_1 - u_2)(y) = 0$ everywhere. Since \mathcal{F} is one-one on \mathcal{S} , we conclude that $u_1 = u_2$.

A deeper use of the Schwartz space in connection with linear partial differential equations comes about because of the relationship between the Schwartz space and the theory of “distributions.” Distributions are continuous linear functionals on vector spaces of smooth functions, i.e., continuous linear maps from such a space to the scalars, and they will be considered more extensively in Chapter V. For now, we shall be content with discussing “tempered distributions,” the distributions associated with the Schwartz space. In order to obtain a well-defined notion of continuity, we shall describe how to make $\mathcal{S}(\mathbb{R}^N)$ into a metric space.

For each pair of polynomials P and Q , we define

$$\|f\|_{P,Q} = \sup_{x \in \mathbb{R}^N} |P(x)(Q(D)f)(x)|.$$

Each function $\|\cdot\|_{P,Q}$ on \mathcal{S} is a **seminorm** on \mathcal{S} in the sense that³

- (i) $\|f\|_{P,Q} \geq 0$ for all f in \mathcal{S} ,
- (ii) $\|cf\|_{P,Q} = |c|\|f\|_{P,Q}$ for all f in \mathcal{S} and all scalars c ,
- (iii) $\|f + g\|_{P,Q} \leq \|f\|_{P,Q} + \|g\|_{P,Q}$ for all f and g in \mathcal{S} .

Collectively these seminorms have a property that goes in the converse direction to (i), namely

- (iv) $\|f\|_{P,Q} = 0$ for all P and Q implies $f = 0$.

In fact, f will already be 0 if the seminorm for $P = Q = 1$ is 0 on f .

Each seminorm gives rise to a pseudometric $d_{P,Q}(f, g) = \|f - g\|_{P,Q}$ in the usual way, and the topology on \mathcal{S} is the weakest topology making all the functions $d_{P,Q}(\cdot, g)$ continuous. That is, a base for the topology consists of all sets $U_{g,P,Q,n} = \{f \mid \|f - g\|_{P,Q} < 1/n\}$.

A feature of \mathcal{S} is that only countably many of the seminorms are relevant for obtaining the open sets, and a consequence is that the topology of \mathcal{S} is defined by a metric. The important seminorms are the ones in which P and Q are monomials, each with coefficient 1. In fact, if $P(x) = \sum_{\alpha} a_{\alpha}x^{\alpha}$ and $Q(x) = \sum_{\beta} b_{\beta}x^{\beta}$, then it is easy to check that $d_{P,Q}(f, g) \leq \sum_{\alpha,\beta} |a_{\alpha}b_{\beta}|d_{x^{\alpha},x^{\beta}}(f, g)$. Hence any open set that $d_{P,Q}$ defines is a union of finite intersections of the open sets defined by the finitely many $d_{x^{\alpha},y^{\beta}}$'s.

³The reader may notice that the definition of “seminorm” is the same as the definition of “pseudonorm” in *Basic*. The only distinction is that the word “seminorm” is often used in the context of a whole family of such objects, while the word “pseudonorm” is often used when there is only one such object under consideration.

Let us digress and consider the situation more abstractly because it will arise again later. Suppose we have a real or complex vector space V on which are defined countably many seminorms $\| \cdot \|_n$ satisfying (i), (ii), and (iii) above.

Each seminorm $\| \cdot \|_n$ gives rise to a pseudometric \tilde{d}_n on V and then to open sets defined relative to \tilde{d}_n . For any pseudometric $\tilde{\rho}$, the function $\rho = \min\{1, \tilde{\rho}\}$ is easily checked to be a pseudometric, and ρ defines the same open sets on V as $\tilde{\rho}$ does. We shall use the following abstract result about pseudometrics; this was proved as Proposition 10.28 of *Basic*, and we therefore omit the proof here.

Proposition 3.1. Suppose that V is a nonempty set and $\{d_n\}_{n \geq 1}$ is a sequence of pseudometrics on V such that $d_n(x, y) \leq 1$ for all n and for all x and y in V . Then $d(x, y) = \sum_{n=1}^{\infty} 2^{-n} d_n(x, y)$ is a pseudometric. If the open balls relative to d_n are denoted by $B_n(r; x)$ and the open balls relative to d are denoted by $B(r; x)$, then the B_n 's and B 's are related as follows:

- (a) whenever some $B_n(r_n; x)$ is given with $r_n > 0$, there exists some $B(r; x)$ with $r > 0$ such that $B(r; x) \subseteq B_n(r_n; x)$,
- (b) whenever $B(r; x)$ is given with $r > 0$, there exist finitely many $r_n > 0$, say for $n \leq K$, such that $\bigcap_{n=1}^K B_n(r_n; x) \subseteq B(r; x)$.

In the situation with countably many seminorms $\| \cdot \|_n$ for the vector space V , we see that we can introduce a pseudometric d such that three conditions hold:

- $d(x, y) = d(0, y - x)$ for all x and y ,
- whenever some x in V is given and an index n and corresponding number $r_n > 0$ are given, then there is a number $r > 0$ such that $d(x, y) < r$ implies $\|y - x\|_n < r_n$,
- whenever some x in V is given and some $r > 0$ is given, then there exist finitely many $r_n > 0$, say for $n \leq K$, such that any y with $\|y - x\|_n < r_n$ for $n \leq K$ implies $d(x, y) < r$.

If the seminorms collectively have the property that $\|x\|_n = 0$ for all n only for $x = 0$, then d is a metric, and we say that the family of seminorms is a **separating family**. The specific form of d is not important: in the case of \mathcal{S} , the metric d depended on the choice of the countable subfamily of pseudometrics and the order in which they were enumerated, and these choices do not affect any results about \mathcal{S} . The important thing about this construction is that it shows that the topology is given by *some* metric.

The three conditions marked with bullets enable us to detect continuity of linear functions with domain V and range another such space W by using the seminorms directly.

Proposition 3.2. Let $L : V \rightarrow W$ be a linear function between vector spaces that are both real or both complex. Suppose that V is topologized by means of

countably many seminorms $\|\cdot\|_{V,m}$ and W is topologized by means of countably many seminorms $\|\cdot\|_{W,n}$. Then L is continuous if and only if for each n , there is a finite set $F = F(n)$ of m 's and there are corresponding positive numbers δ_m such that $\|v\|_{V,m} \leq \delta_m$ for all $m \in F$ implies $\|L(v)\|_{W,n} \leq 1$.

PROOF. Let d_V and d_W be the distance functions in V and W . When n is given, the second item in the bulleted list shows that there is some $r > 0$ such that $d_W(0, w) \leq r$ implies $\|w\|_{W,n} \leq 1$. If L is continuous at 0, then there is a $\delta > 0$ such that $d_V(0, v) \leq \delta$ implies $d_W(0, L(v)) \leq r$. From the third item in the bulleted list, we know that there is a finite set F of indices m and there are corresponding numbers $\delta_m > 0$ such that $\|v\|_{V,m} \leq \delta_m$ implies $d_V(0, v) \leq \delta$. Then $\|v\|_{V,m} \leq \delta_m$ for all m in F implies $\|L(v)\|_{W,n} \leq 1$.

Conversely suppose for each n that there is a finite set F and there are numbers $\delta_m > 0$ for m in F such that the stated condition holds. To see that L is continuous at 0, let $\epsilon > 0$ be given. Choose K and numbers $\epsilon_n > 0$ for $n \leq K$ such that $\|w\|_{W,n} \leq \epsilon_n$ for $n \leq K$ implies $d_W(0, w) \leq \epsilon$. For each $n \leq K$, the given condition on L allows us to find a finite set F_n of indices m and numbers $\delta_m > 0$ such that $\|v\|_{V,m} \leq \delta_m$ implies $\|L(v)\|_{W,n} \leq 1$. If $\|v\|_{V,m} \leq \delta_m \epsilon_n$ for all m in $F = \bigcup_{n \leq K} F_n$, then $\|L(v)\|_{W,n} \leq \epsilon_n$ for all $n \leq K$ and hence $d_W(0, L(v)) \leq \epsilon$. We know that there is a number $\delta > 0$ such that $d_V(0, v) \leq \delta$ implies $\|v\|_{V,m} \leq \delta_m \epsilon_n$ for all m in F , and then $d_W(0, L(v)) \leq \epsilon$. Hence L is continuous at 0.

Once L is continuous at 0, it is continuous everywhere because of the translation invariance of d_V and d_W : $d_V(v_1, v_2) = d_V(0, v_2 - v_1)$ and $d_W(L(v_1), L(v_2)) = d_W(0, L(v_2) - L(v_1)) = d_W(0, L(v_2 - v_1))$. \square

Now we return to the Schwartz space \mathcal{S} to apply our construction and Proposition 3.2. The bulleted items above make it clear that it does not matter which countable set of generating seminorms we use nor what order we put them in; the open sets and the criterion for continuity are still the same. The following corollary is immediate from Proposition 3.2, the definition of \mathcal{S} , and the behavior of the Fourier transform under multiplication by polynomials and under differentiation.

Corollary 3.3. For the Schwartz space \mathcal{S} on \mathbb{R}^N ,

- (a) a linear functional ℓ is continuous if and only if there is a finite set F of pairs (P, Q) of polynomials and there are corresponding numbers $\delta_{P,Q} > 0$ such that $\|f\|_{P,Q} \leq \delta_{P,Q}$ for all (P, Q) in F implies $|\ell(f)| \leq 1$.
- (b) the Fourier transform mapping $\mathcal{F} : \mathcal{S} \rightarrow \mathcal{S}$ is continuous, and so is its inverse.

A continuous linear functional on the Schwartz space is called a **tempered distribution**, and the space of all tempered distributions is denoted by $\mathcal{S}' =$

$\mathcal{S}'(\mathbb{R}^N)$. It will be convenient to write $\langle T, \varphi \rangle$ for the value of the tempered distribution T on the Schwartz function φ . The space of tempered distributions is huge. A few examples will give an indication just how huge it is.

EXAMPLES.

(1) Any function f on \mathbb{R}^N with $|f(x)| \leq (1 + |x|^2)^n |g(x)|$ for some integer n and some integrable function g defines a tempered distribution T by integration: $\langle T, \varphi \rangle = \int_{\mathbb{R}^N} f(x)\varphi(x) dx$ when φ is in \mathcal{S} . In view of Corollary 3.3a, the continuity follows from the chain of inequalities

$$\begin{aligned} |\langle T, \varphi \rangle| &\leq \int_{\mathbb{R}^N} (|f(x)|(1 + |x|^2)^{-n})(1 + |x|^2)^n |\varphi(x)| dx \\ &\leq \left(\int_{\mathbb{R}^N} |g(x)| dx \right) \left(\sup_x \{(1 + |x|^2)^n |\varphi(x)|\} \right) \\ &= \|g\|_1 \|\varphi\|_{P,1} \quad \text{for } P(x) = (1 + |x|^2)^n. \end{aligned}$$

(2) Any function f with $|f(x)| \leq (1 + |x|^2)^n |g(x)|$ for some integer n and some function g in $L^\infty(\mathbb{R}^N)$ defines a tempered distribution T by integration: $\langle T, \varphi \rangle = \int_{\mathbb{R}^N} f(x)\varphi(x) dx$. In fact, $|f(x)| \leq (1 + |x|^2)^{n+N} ((1 + |x|^2)^{-N} |g(x)|)$, and $(1 + |x|^2)^{-N} |g(x)|$ is integrable; hence this example is an instance of Example 1.

(3) Any function f with $|f(x)| \leq (1 + |x|^2)^n |g(x)|$ for some integer n and some function g in $L^p(\mathbb{R}^N)$, where $1 \leq p \leq \infty$, defines a tempered distribution T by integration because such a distribution is the sum of one as in Example 1 and one as in Example 2.

(4) Suppose that f is as in Example 3 and that $Q(D)$ is a constant-coefficients partial differential operator. Then the formula $\langle T, \varphi \rangle = \int_{\mathbb{R}^N} f(x)(Q(D)\varphi)(x) dx$ defines a tempered distribution.

(5) In the above examples, Lebesgue measure dx may be replaced by any Borel measure $d\mu(x)$ on \mathbb{R}^N such that $\int_{\mathbb{R}^N} (1 + |x|^2)^{n_0} d\mu(x) < \infty$ for some n_0 . A particular case of interest is that $d\mu(x)$ is a point mass at a point x_0 ; in this case, the tempered distributions $\varphi \mapsto \langle T, \varphi \rangle$ that are obtained by combining the above constructions are the linear combinations of iterated partial derivatives of φ at the point x_0 .

(6) Any finite linear combination of tempered distributions as in Example 5 is again a tempered distribution.

Two especially useful operations on tempered distributions are multiplication by a Schwartz function and differentiation. Both of these definitions are arranged to be extensions of the corresponding operations on Schwartz functions. The definitions are $\langle \psi T, \varphi \rangle = \langle T, \psi \varphi \rangle$ and $\langle D^\alpha T, \varphi \rangle = (-1)^{|\alpha|} \langle T, D^\alpha \varphi \rangle$; in the latter case the factor $(-1)^{|\alpha|}$ is included because integration by parts requires its presence when T is given by a Schwartz function.

A useful feature of distributions in connection with differential equations, as we shall see in more detail in later chapters, is that we can first look for solutions of a given differential equation that are distributions and then consider how close those distributions are to being functions. The special feature of *tempered* distributions is that the Fourier transform makes sense on them, as follows.

As with the operations of multiplication by a Schwartz function and differentiation, the definition of Fourier transform of a tempered distribution is arranged to be an extension of the definition of the Fourier transform of a member ψ of \mathcal{S} when we identify the function ψ with the distribution $\psi(x) dx$. If φ is in \mathcal{S} , then $\int \widehat{\psi} \varphi dx = \int \psi \widehat{\varphi} dx$ by the multiplication formula,⁴ which we reinterpret as $\langle \mathcal{F}(\psi dx), \varphi \rangle = \langle \psi dx, \widehat{\varphi} \rangle$. The definition is

$$\langle \mathcal{F}(T), \varphi \rangle = \langle T, \widehat{\varphi} \rangle$$

for $T \in \mathcal{S}'$ and $\varphi \in \mathcal{S}$. To see that $\mathcal{F}(T)$ is in \mathcal{S}' , we have to check that $\mathcal{F}(T)$ is continuous. The definition is $\mathcal{F}(T) = T \circ \mathcal{F}$, and \mathcal{F} is continuous on \mathcal{S} by Corollary 3.3b. Thus the Fourier transform carries tempered distributions to tempered distributions.

Proposition 3.4. The Fourier transform \mathcal{F} is one-one from $\mathcal{S}'(\mathbb{R}^N)$ onto $\mathcal{S}'(\mathbb{R}^N)$.

PROOF. If T is in \mathcal{S}' and $\mathcal{F}(T) = 0$, then $\langle T, \mathcal{F}(\varphi) \rangle = 0$ for all φ in \mathcal{S} . Since \mathcal{F} carries \mathcal{S} onto \mathcal{S} , $\langle T, \psi \rangle = 0$ for all ψ in \mathcal{S} , and thus $T = 0$. Therefore \mathcal{F} is one-one on \mathcal{S}' .

If T' is given in \mathcal{S}' , put $T = T' \circ \mathcal{F}^{-1}$, where \mathcal{F}^{-1} is the inverse Fourier transform as a map of \mathcal{S} to itself. Then $T' = T \circ \mathcal{F}$ and $\mathcal{F}(T) = T \circ \mathcal{F} = T'$. Therefore \mathcal{F} is onto \mathcal{S}' . \square

2. Weak Derivatives and Sobolev Spaces

A careful study of a linear partial differential equation often requires attention to the domain of the operator, and it is helpful to be able to work with partial derivatives without investigating a problem of interchange of limits at each step. Sobolev spaces are one kind of space of functions that are used for this purpose, and their definition involves “weak derivatives.” At the end one wants to be able to deduce results about ordinary partial derivatives from results about weak derivatives, and Sobolev’s Theorem does exactly that.

We shall make extensive use in this book of techniques for regularizing functions that have been developed in *Basic*. Let us assemble a number of these in one place for convenient reference.

⁴Proposition 8.1e of *Basic*.

Proposition 3.5.

(a) (Theorems 6.20 and 9.13) Let φ be in $L^1(\mathbb{R}^N, dx)$, define $\varphi_\varepsilon(x) = \varepsilon^{-N}\varphi(\varepsilon^{-1}x)$ for $\varepsilon > 0$, and put $c = \int_{\mathbb{R}^N} \varphi(x) dx$.

(i) If f is in $L^p(\mathbb{R}^N, dx)$ with $1 \leq p < \infty$, then

$$\lim_{\varepsilon \downarrow 0} \|\varphi_\varepsilon * f - cf\|_p = 0.$$

(ii) If f is bounded on \mathbb{R}^N and is continuous at x , then $\lim_{\varepsilon \downarrow 0} (\varphi_\varepsilon * f)(x) = cf(x)$, and the convergence is uniform for any set E of x 's such that f is uniformly continuous at the points of E .

(b) (Proposition 9.9) If μ is a Borel measure on a nonempty open set U in \mathbb{R}^N and if $1 \leq p < \infty$, then $L^p(U, \mu)$ is separable, and $C_{\text{com}}(U)$ is dense in $L^p(U, \mu)$.

(c) (Corollary 6.19) Suppose that φ is a compactly supported function of class C^n on \mathbb{R}^N and that f is in $L^p(\mathbb{R}^N, dx)$ with $1 \leq p \leq \infty$. Then $\varphi * f$ is of class C^n , and $D^\alpha(\varphi * f) = (D^\alpha\varphi) * f$ for any iterated partial derivative D^α of order $\leq n$.

(d) (Lemma 8.11) If δ_1 and δ_2 are given positive numbers with $\delta_1 < \delta_2$, then there exists ψ in $C_{\text{com}}^\infty(\mathbb{R}^N)$ with values in $[0, 1]$ such that $\psi(x) = \psi_0(|x|)$, ψ_0 is nonincreasing, $\psi(x) = 1$ for $|x| \leq \delta_1$, and $\psi(x) = 0$ for $|x| \geq \delta_2$.

(e) (Consequence of (d)) If $\delta > 0$, then there exists $\varphi \geq 0$ in $C_{\text{com}}^\infty(\mathbb{R}^N)$ such that $\varphi(x) = \varphi_0(|x|)$ with φ_0 nonincreasing, $\varphi(x) = 0$ for $|x| \geq 1$, and $\int_{\mathbb{R}^N} \varphi(x) dx = 1$.

(f) (Proposition 8.12) If K and U are subsets of \mathbb{R}^N with K compact, U open, and $K \subseteq U$, then there exists $\varphi \in C_{\text{com}}^\infty(U)$ with values in $[0, 1]$ such that φ is identically 1 on K .

In this section we work with a nonempty open subset U of \mathbb{R}^N , an index p satisfying $1 \leq p < \infty$, and the spaces $L^p(U) = L^p(U, dx)$, the underlying measure being understood to be Lebesgue measure. Let $p' = p/(p-1)$ be the dual index. For Sobolev's Theorem, we shall impose two additional conditions on U , namely boundedness for U and a certain regularity condition for the **boundary** $\partial U = U^{\text{cl}} - U$ of the open set U , but we do not impose those additional conditions yet.

Corollary 3.6. If U is a nonempty open subset of \mathbb{R}^N , then $C_{\text{com}}^\infty(U)$ is

- (a) uniformly dense in $C_{\text{com}}(U)$,
- (b) dense in $L^p(U)$ for every p with $1 \leq p < \infty$.

In (a), any member of $C_{\text{com}}(U)$ is the uniform limit of members of $C_{\text{com}}^\infty(U)$.

PROOF. Let f in $C_{\text{com}}(U)$ be given. Choose by Proposition 3.5e a function φ in $C_{\text{com}}^{\infty}(\mathbb{R}^N)$ that is ≥ 0 , vanishes outside the unit ball about the origin, and has total integral 1. For $\varepsilon > 0$, define $\varphi_{\varepsilon}(x) = \varepsilon^{-N}\varphi(\varepsilon^{-1}x)$. The function $\varphi_{\varepsilon} * f$ is of class C^{∞} by (c). If $U = \mathbb{R}^N$, let $\varepsilon_0 = 1$; otherwise let ε_0 be the distance from the support of f to the complement of U . For $\varepsilon < \varepsilon_0$, $\varphi_{\varepsilon} * f$ has compact support contained in U . As ε decreases to 0, Proposition 3.5a shows that $\|\varphi_{\varepsilon} * f - f\|_{\text{sup}}$ tends to 0 and so does $\|\varphi_{\varepsilon} * f - f\|_p$. This proves the first conclusion of the corollary and proves also that $C_{\text{com}}^{\infty}(U)$ is L^p dense in $C_{\text{com}}(U)$ if $1 \leq p < \infty$. Since Proposition 3.5b shows that $C_{\text{com}}(U)$ is dense in $L^p(U)$, the second conclusion of the corollary follows. \square

Suppose that f and g are two complex-valued functions that are **locally integrable** on U in the sense of being integrable on each compact subset of U . If α is a differentiation index, we say that $D^{\alpha}f = g$ in the sense of **weak derivatives** if

$$\int_U f(x) D^{\alpha} \varphi(x) dx = (-1)^{|\alpha|} \int_U g(x) \varphi(x) dx \quad \text{for all } \varphi \in C_{\text{com}}^{\infty}(U).$$

The definition is arranged so that g gives the result that one would expect for iterated partial differentiation of type α if the integrated or boundary term gives 0 at each stage. More precisely if f is in $C^{|\alpha|}(U)$, then the weak derivative of order α exists and is the pointwise derivative. To prove this, it is enough to handle a first-order partial derivative $D_j h$ for a function h in $C^1(U)$, showing that $\int_U h D_j \varphi dx = - \int_U (D_j h) \varphi dx$ for $\varphi \in C_{\text{com}}^{\infty}(U)$, i.e., that $\int_U D_j (h\varphi) dx = 0$. Because φ is compactly supported in U , $\psi = h\varphi$ makes sense as a compactly supported C^1 function on \mathbb{R}^N , and we are to prove that $\int_{\mathbb{R}^N} D_j \psi dx = 0$. The Fundamental Theorem of Calculus gives $\int_{-a}^a D_j \psi dx_j = [\psi]_{x_j=-a}^{x_j=a}$ for $a > 0$, and the compact support implies that this is 0 for a sufficiently large. Thus $\int_{\mathbb{R}} D_j \psi dx_j = 0$, and Fubini's Theorem gives $\int_{\mathbb{R}^N} D_j \psi dx = 0$.

The function g in the definition of weak derivative is unique up to sets of measure 0 if it exists. In fact, if g_1 and g_2 are both weak derivatives of order α , then $\int_U (g_1 - g_2) \varphi dx = 0$ for all φ in $C_{\text{com}}^{\infty}(U)$. Fix an open set V having compact closure contained in U . If f is in $C_{\text{com}}(V)$, then Corollary 3.6a produces a sequence of functions φ_n in $C_{\text{com}}^{\infty}(V)$ tending uniformly to f . Since $g_1 - g_2$ is integrable on V , the equalities $\int_V (g_1 - g_2) \varphi_n dx = 0$ for all n imply $\int_V (g_1 - g_2) f dx = 0$. By the uniqueness in the Riesz Representation Theorem, $g_1 = g_2$ a.e. on V . Since V is arbitrary, $g_1 = g_2$ a.e. on U .

EXAMPLE. In the open set $U = (-1, 1) \subseteq \mathbb{R}^1$, the function $e^{i/|x|}$ is locally integrable and is differentiable except at $x = 0$, but it does not have a weak derivative. In fact, if it had g as a weak derivative, we could use φ 's vanishing in

neighborhoods of the origin to see that $g(x)$ has to be $-ix^{-2}(\operatorname{sgn} x)e^{i/|x|}$ almost everywhere. But this function is not locally integrable on U .

If f has α^{th} weak derivative $D^\alpha f$ and $D^\alpha f$ has β^{th} weak derivative $D^\beta(D^\alpha f)$, then f has $(\beta + \alpha)^{\text{th}}$ weak derivative $D^{\beta+\alpha}f$ and $D^{\beta+\alpha}f = D^\beta(D^\alpha f)$. In fact, if φ is in $C_{\text{com}}^\infty(U)$, then this conclusion follows from the computation

$$\begin{aligned} \int_U f D^{\beta+\alpha} \varphi \, dx &= \int_U f D^\alpha (D^\beta \varphi) \, dx = (-1)^{|\alpha|} \int_U D^\alpha f D^\beta \varphi \, dx \\ &= (-1)^{|\alpha|+|\beta|} \int_U D^\beta (D^\alpha f) \varphi \, dx. \end{aligned}$$

If f has weak j^{th} partial derivative $D_j f$ and if ψ is in $C^\infty(U)$, then $f\psi$ has a weak j^{th} partial derivative, and it is given by $(D_j f)\psi + f(D_j \psi)$. In fact, this conclusion holds because $\int_U f\psi(D_j \varphi) \, dx = \int_U f D_j(\psi\varphi) \, dx - \int_U f(D_j \psi)\varphi \, dx = -\int_U (D_j f)\psi\varphi \, dx - \int_U f(D_j \psi)\varphi \, dx = -\int_U (f(D_j \psi) + (D_j f)\psi)\varphi \, dx$.

If f has β^{th} weak derivative $D^\beta f$ for every β with $\beta \leq \alpha$ and if ψ is in $C^\infty(U)$, then $f\psi$ has an α^{th} weak derivative. It is given by the **Leibniz rule**:

$$D^\alpha(f\psi) = \sum_{\beta \leq \alpha} \frac{\alpha!}{\beta!(\alpha-\beta)!} (D^\beta f)(D^{\alpha-\beta} \psi).$$

This formula follows by iterating the formula for $D_j(f\psi)$ in the previous paragraph.

Now we can give the definition of Sobolev spaces. Let $k \geq 0$ be an integer, and let $1 \leq p < \infty$. Define

$$L_k^p(U) = \{f \in L^p(U) \mid \text{all } D^\alpha f \text{ exist weakly for } |\alpha| \leq k \text{ and are in } L^p(U)\}.$$

Then $L_k^p(U)$ is a vector space, and we make it into a normed linear space by defining

$$\|f\|_{L_k^p} = \left(\sum_{|\alpha| \leq k} \int_U |D^\alpha f|^p \, dx \right)^{1/p}.$$

The normed linear spaces $L_k^p(U)$ are the **Sobolev spaces** for U . All the remaining results in this section concern these spaces.⁵

⁵The subject of partial differential equations makes use of a number of families that generalize these spaces in various ways. Of particular importance is a family H^s such that $H^s = L_k^2$ when s is an integer $k \geq 0$ but s is a continuous real parameter with $-\infty < s < \infty$. The spaces $H^s(\mathbb{R}^N)$ are introduced in Problems 8–12 at the end of the chapter. For an open set U , the two spaces $H_{\text{com}}^s(U)$ and $H_{\text{loc}}^s(U)$ are introduced in Chapter VIII. All of these spaces are called **Sobolev spaces**.

Proposition 3.7. If $k \geq 0$ is an integer and if $1 \leq p < \infty$, then the normed linear space $L_k^p(U)$ is complete.

PROOF. If $\{f_m\}$ is a Cauchy sequence in $L_k^p(U)$, then for each α with $|\alpha| \leq k$, the sequence $\{D^\alpha f_m\}$ is Cauchy in $L^p(U)$. Since $L^p(U)$ is complete, we can define $f^{(\alpha)}$ to be the $L^p(U)$ limit of $D^\alpha f_m$. For φ in $C_{\text{com}}^\infty(U)$, we then have

$$\int_U f^{(\alpha)} \varphi \, dx = \int_U (\lim_m D^\alpha f_m) \varphi \, dx = \lim_m \int_U (D^\alpha f_m) \varphi \, dx,$$

the second equality holding since φ is in the dual space $L^{p'}(U)$. In turn, this expression is equal to

$$(-1)^{|\alpha|} \lim_m \int_U (f_m)(D^\alpha \varphi) \, dx = (-1)^{|\alpha|} \int_U (f^{(0)})(D^\alpha \varphi) \, dx,$$

the second equality holding since $D^\alpha \varphi$ is in $L^{p'}(U)$. Therefore $f^{(\alpha)} = D^\alpha f^{(0)}$ and f_m tends to $f^{(0)}$ in $L_k^p(U)$. \square

Proposition 3.8. If $k \geq 0$ is an integer and if $1 \leq p < \infty$, then a function f is in $L_k^p(U)$ if f is in $L^p(U)$ and there exists a sequence $\{f_m\}$ in $C^k(U)$ such that

- (a) $\lim_m \|f - f_m\|_p = 0$,
- (b) for each α with $|\alpha| \leq k$, the iterated pointwise partial derivative $D^\alpha f_m$ is in $L^p(U)$ and converges in $L^p(U)$ as m tends to infinity.

PROOF. By (b), $\|D^\alpha (f_l - f_m)\|_p^p$ for each fixed α tends to 0 as l and m tend to infinity. Summing on α and taking the p^{th} root, we see that $\|f_l - f_m\|_{L_k^p}$ tends to 0. In other words, $\{f_m\}$ is Cauchy in $L_k^p(U)$. By Proposition 3.7, $\{f_m\}$ converges to some g in $L_k^p(U)$. The limit function g has to have the property that $\|f_m - g\|_p$ tends to 0, and (a) shows that we must have $g = f$. Therefore f is in $L_k^p(U)$. \square

The key theorem is the following converse to Proposition 3.8.

Theorem 3.9. If $k \geq 0$ is an integer and if $1 \leq p < \infty$, then $C^\infty(U) \cap L_k^p(U)$ is dense in $L_k^p(U)$.

On the other hand, despite Corollary 3.6b, it will be a consequence of Sobolev's Theorem that $C_{\text{com}}^\infty(U)$ is not dense in $L_k^p(U)$ if k is sufficiently large. The proof of the present theorem will be preceded by a lemma affirming that at least the members of $L_k^p(U)$ with compact support in U can be approximated by members of $C_{\text{com}}^\infty(U)$.

In addition, the proof of the theorem will make use of an "exhausting sequence" and a smooth partition of unity based on it. Since U is locally compact and σ -compact, we can find a sequence $\{K_n\}_{n=1}^\infty$ of compact subsets of U with union

U such that $K_n \subseteq K_{n+1}^o$ for all n . This sequence is called an **exhausting sequence** for U . We construct the partition of unity $\{\psi_n\}_{n \geq 1}$ as follows. For $n \geq 1$, we use Proposition 3.5f to choose a C^∞ function φ_n with values in $[0, 1]$ such that

$$\varphi_1(x) = \begin{cases} 1 & \text{for } x \in K_3, \\ 0 & \text{for } x \in (K_4^o)^c, \end{cases}$$

and for $n \geq 2$,

$$\varphi_n(x) = \begin{cases} 1 & \text{for } x \in K_{n+2} - K_{n+1}^o, \\ 0 & \text{for } x \in (K_{n+3}^o)^c \cup K_n. \end{cases}$$

In the sum $\sum_{n=1}^{\infty} \varphi_n(x)$, each x has a neighborhood in which only finitely many terms are nonzero and some term is nonzero. Therefore $\varphi = \sum_{n=1}^{\infty} \varphi_n$ is a well-defined member of $C^\infty(U)$. If we put $\psi_n = \varphi_n / \varphi$, then ψ_n is in $C^\infty(U)$, $\sum_{n=1}^{\infty} \psi_n = 1$ on U , $\psi_1(x)$ is > 0 on K_3 and is $= 0$ on $(K_4^o)^c$, and for $n \geq 2$,

$$\psi_n(x) \begin{cases} > 0 & \text{for } x \in K_{n+2} - K_{n+1}^o, \\ = 0 & \text{for } x \in (K_{n+3}^o)^c \cup K_n. \end{cases}$$

Lemma 3.10. Let φ be a member of $C_{\text{com}}^\infty(\mathbb{R}^N)$ vanishing for $|x| \geq 1$ and having total integral 1, put $\varphi_\varepsilon(x) = \varepsilon^{-N} \varphi(\varepsilon^{-1}x)$ for $\varepsilon > 0$, and let f be a function in $L_k^p(U)$ whose support is a compact subset of U . For ε sufficiently small, $\varphi_\varepsilon * f$ is in $C_{\text{com}}^\infty(U)$, and

$$\lim_{\varepsilon \downarrow 0} \|\varphi_\varepsilon * f - f\|_{L_k^p} = 0.$$

PROOF. As in the proof of Corollary 3.6, $\varphi_\varepsilon * f$ has compact support contained in U if $\varepsilon < \varepsilon_0$, where ε_0 is 1 if $U = \mathbb{R}^N$ and ε_0 is the distance of the support of f to the complement of U if $U \neq \mathbb{R}^N$. Moreover, the function $\varphi_\varepsilon * f$ is in $C^\infty(\mathbb{R}^N)$ with $D^\alpha(\varphi_\varepsilon * f) = (D^\alpha \varphi_\varepsilon) * f$ for each α . Thus $\varphi_\varepsilon * f$ is in $C_{\text{com}}^\infty(U)$ if $\varepsilon < \varepsilon_0$. By the first remark after the definition of weak derivative, $\varphi_\varepsilon * f$ has weak derivatives of all orders for $\varepsilon < \varepsilon_0$, and they are given by the ordinary derivatives $D^\alpha(\varphi_\varepsilon * f)$. For $\varepsilon < \varepsilon_0$,

$$\begin{aligned} D^\alpha(\varphi_\varepsilon * f)(x) &= \int_U f(y) (D^\alpha \varphi_\varepsilon)(x - y) dy \\ &= (-1)^{|\alpha|} \int_U f(y) D^\alpha(y \mapsto \varphi_\varepsilon(x - y)) dy. \end{aligned}$$

Since f by assumption has weak derivatives through order k and since $y \mapsto \varphi_\varepsilon(x - y)$ has compact support in U , the right side is equal to

$$\int_U D^\alpha f(y) \varphi_\varepsilon(x - y) dy = (\varphi_\varepsilon * D^\alpha f)(x)$$

for $|\alpha| \leq k$. Therefore, for $\varepsilon < \varepsilon_0$ and $|\alpha| \leq k$, we have

$$\|D^\alpha(\varphi_\varepsilon * f - f)\|_p = \|\varphi_\varepsilon * (D^\alpha f) - D^\alpha f\|_p.$$

For these same α 's, Proposition 3.5a shows that the right side tends to 0 as ε tends to 0. Therefore $\varphi_\varepsilon * f - f$ tends to 0 in $L_k^p(U)$. \square

PROOF OF THEOREM 3.9. Let f be in $L_k^p(U)$. The idea is to break f into a countable sum of functions of compact support, apply the lemma to each piece, and add the results. The difficulty lies in arranging that each of the pieces of f have controlled weak derivatives through order k . Thus instead of using indicator functions to break up f , we shall use an exhausting sequence $\{K_n\}_{n \geq 1}$ and an associated partition of unity $\{\psi_n\}_{n \geq 1}$ of the kind described after the statement of the theorem. The discussion above concerning the Leibniz rule shows that each $\psi_n f$ has weak derivatives of all orders $\leq k$, and the construction shows that $\psi_n f$ has support in K_5^o for $n = 1$ and in $K_{n+4}^o - K_{n-1}$ for $n \geq 2$.

Let $\epsilon > 0$ be given, let φ be a member of $C_{\text{com}}^\infty(\mathbb{R}^N)$ vanishing for $|x| \geq 1$ and having total integral 1, and put $\varphi_\epsilon(x) = \epsilon^{-N} \varphi(\epsilon^{-1}x)$ for $\epsilon > 0$. Applying Lemma 3.10 to $\psi_n f$, choose $\epsilon_n > 0$ small enough so that the function $u_n = \varphi_{\epsilon_n} * (\psi_n f)$ has support in K_5^o for $n = 1$ and in $K_{n+4}^o - K_{n-1}$ for $n \geq 2$ and so that

$$\|u_n - \psi_n f\|_{L_k^p} < 2^{-n} \epsilon.$$

Put $u = \sum_{n=1}^\infty u_n$. Each x in U has a neighborhood on which only finitely many of the functions u_n are not identically 0, and therefore u is in $C^\infty(U)$. Also,

$$u = \sum_{n=1}^\infty (u_n - \psi_n f) + f \quad \text{since} \quad \sum_{n=1}^\infty \psi_n = 1.$$

Since for each compact subset of U , only finitely many $u_n - \psi_n f$ are not identically 0 on that set, the weak derivatives of order $\leq k$ satisfy $D^\alpha u = \sum_{n=1}^\infty D^\alpha (u_n - \psi_n f) + D^\alpha f$. Hence

$$D^\alpha (u - f) = \sum_{n=1}^\infty D^\alpha (u_n - \psi_n f).$$

Minkowski's inequality for integrals therefore gives

$$\|D^\alpha (u - f)\|_p \leq \sum_{n=1}^\infty \|D^\alpha (u_n - \psi_n f)\|_p \leq \sum_{n=1}^\infty \|u_n - \psi_n f\|_{L_k^p} \leq \sum_{n=1}^\infty \frac{\epsilon}{2^n} = \epsilon.$$

Finally we raise both sides to the p^{th} power, sum for α with $|\alpha| \leq k$, and extract the p^{th} root. If $m(k)$ denotes the number of such α 's, we obtain

$$\|u - f\|_{L_k^p} \leq m(k)^{1/p} \epsilon,$$

and the proof is complete. \square

Now we come to Sobolev's Theorem. For the remainder of the section, the open set U will be assumed bounded, and we shall impose a regularity condition on its boundary $\partial U = U^{\text{cl}} - U$. When we isolate one of the coordinates of points in \mathbb{R}^N , say the j^{th} , let us write y' for the other $N - 1$ coordinates, so that $y = (y_j, y')$. We say that U **satisfies the cone condition** if there exist positive constants c and h such that for each x in U , there are a sign \pm and an index j with $1 \leq j \leq N$ for which the closed truncated cone

$$\Gamma_x = x + \{y = (y_j, y') \mid \pm y_j \geq c|y'| \text{ and } |y| \leq h\}$$

lies in U for one choice of the sign \pm . See Figure 3.1. Problem 4 at the end of the chapter observes that if the bounded open set U has a C^1 boundary in a certain sense, then U satisfies the cone condition.

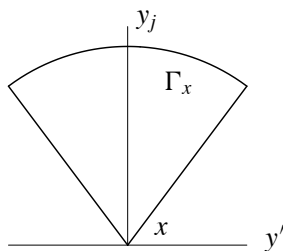

FIGURE 3.1. Cone condition for a bounded open set.

Theorem 3.11 (Sobolev's Theorem). Let U be a nonempty bounded open set in \mathbb{R}^N , and suppose that U satisfies the cone condition with constants c and h . If $1 \leq p < \infty$ and $k > N/p$, then there exists a constant $C = C(N, c, h, p, k)$ such that

$$\sup_{x \in U} |u(x)| \leq C \|u\|_{L_k^p}$$

for all u in $C^\infty(U) \cap L_k^p(U)$.

REMARK. Under the stated conditions on k and p , the theorem says that the inclusion of $C^\infty(U) \cap L_k^p(U)$ into the Banach space $C(U)$ of *bounded* continuous functions on U is a bounded linear operator relative to the norm of $L_k^p(U)$. Since $C^\infty(U) \cap L_k^p(U)$ is dense in $L_k^p(U)$ by Theorem 3.9 and since $C(U)$ is complete, the inclusion extends to a continuous map of $L_k^p(U)$ into $C(U)$. In other words, every member of $L_k^p(U)$ can be regarded as a bounded continuous function on U .

PROOF. Fix g in $C_{\text{com}}^\infty(\mathbb{R}^1)$ with $g(t)$ equal to 1 for $|t| \leq \frac{1}{2}$ and equal to 0 for $|t| \geq \frac{3}{4}$. Fix x in U and its associated sign \pm and index j . We introduce spherical

coordinates about x with the indices reordered so that j comes first, writing $x + y$ for a point near x with

$$\begin{aligned} y_j &= \pm r \cos \varphi, \\ y_1 &= r \sin \varphi \cos \theta_1, \\ &\vdots \quad (\text{with } y_j \text{ omitted}) \\ y_{N-1} &= r \sin \varphi \sin \theta_1 \cdots \sin \theta_{N-3} \cos \theta_{N-2}, \\ y_N &= r \sin \varphi \sin \theta_1 \cdots \sin \theta_{N-3} \sin \theta_{N-2}, \end{aligned}$$

when

$$\begin{aligned} 0 &\leq \varphi \leq \pi, \\ 0 &\leq \theta_i \leq \pi \text{ for } i < N-2, \\ 0 &\leq \theta_{N-2} \leq 2\pi. \end{aligned}$$

All the points $x + y$ with $0 \leq \varphi \leq \Phi(c)$, where $\Phi(c)$ is some positive number and $0 \leq r \leq h$, lie in the cone Γ_x at x . For such φ 's and for $0 \leq t \leq 1$, we define

$$F(t) = g\left(\frac{t}{h}\right)u\left(x + (\pm t \cos \varphi, t \sin \varphi \cos \theta_1, \dots)\right)$$

and expand F in a Taylor series through order $k - 1$ with remainder about the point $t = h$. Because of the behavior of g , F and all its derivatives vanish at $t = h$. Therefore $F(t)$ is given by the remainder term:

$$F(t) = \frac{1}{(k-1)!} \int_h^t (t-s)^{k-1} F^{(k)}(s) ds.$$

Putting $t = 0$, we obtain

$$\begin{aligned} u(x) &= \frac{1}{(k-1)!} \int_h^0 (-r)^{k-1} \frac{\partial^k}{\partial r^k} \left[g\left(\frac{r}{h}\right)u\left(x + (\dots)\right) \right] dr \\ &= \frac{(-1)^k}{(k-1)!} \int_0^h r^{k-N} \frac{\partial^k}{\partial r^k} \left[g\left(\frac{r}{h}\right)u\left(x + (\dots)\right) \right] r^{N-1} dr. \end{aligned}$$

We regard the integral on the right side as taking place over the radial part of the spherical coordinates that describe the set of y 's in Γ_x , and we want to extend the integration over all of Γ_x . To do so, we have to integrate over all values of $\theta_1, \dots, \theta_{N-2}$ and for $0 \leq \varphi \leq \Phi(c)$. We multiply by the spherical part of the Jacobian determinant for spherical coordinates and integrate both sides. The integrand on the left side is constant, being independent of y , and gives a *positive* multiple of $u(x)$. Dividing by that multiple, we get

$$u(x) = c_1 \int_{\Gamma_{x-x}} |y|^{k-N} \frac{\partial^k}{\partial r^k} \left[g\left(\frac{|y|}{h}\right)u(x+y) \right] dy.$$

Suppose temporarily that $p > 1$. With p' still denoting the index dual to p , application of Hölder's inequality gives

$$|u(x)| \leq c_1 \left(\int_{\Gamma_{x-x}} |y|^{(k-N)p'} dy \right)^{1/p'} \left(\int_{\Gamma_{x-x}} \left| \frac{\partial^k}{\partial r^k} \left[g\left(\frac{|y|}{h}\right) u(x+y) \right] \right|^p dy \right)^{1/p}.$$

The first integral on the right side is the critical one. The radius extends from 0 to h , and the integral is finite if and only if $(k - N)p' > -N > 0$, i.e., $k > N - N/p' = N/p$. This is the condition in the theorem.

The differentiation $\frac{\partial^k}{\partial r^k}$ in the second factor on the right can be expanded in terms of derivatives in Cartesian coordinates, and then the integration can be extended over all of U . The result is that the second factor is dominated by a multiple of $\|u\|_{L_k^p}$. This completes the proof when $p > 1$.

Now suppose that $p = 1$. Then the above result from applying Hölder's inequality is replaced by the inequality

$$|u(x)| \leq c_1 \| |y|^{k-N} \|_{\infty, \Gamma_{x-x}} \int_{\Gamma_{x-x}} \left| \frac{\partial^k}{\partial r^k} \left[g\left(\frac{|y|}{h}\right) u(x+y) \right] \right| dy.$$

The first factor is finite if $k \geq N$, and the second factor is handled as before. This completes the proof if $p = 1$. \square

Corollary 3.12. Suppose that U is a nonempty bounded open subset of \mathbb{R}^N satisfying the cone condition, and suppose that $1 < p < \infty$ and that m and k are integers ≥ 0 such that $k > m + N/p$. If f is in $L_k^p(U)$, then f can be redefined on a set of measure 0 so as to be in $C^m(U)$.

PROOF. Choose by Theorem 3.9 a sequence $\{f_i\}$ in $C^\infty(U) \cap L_k^p(U)$ such that $\lim f_i = f$ in $L_k^p(U)$. For $|\alpha| \leq m$, we apply Theorem 3.11 to see that

$$\sup_U |D^\alpha f_i - D^\alpha f_j|$$

tends to 0 as i and j tend to infinity. Thus all the $D^\alpha f_i$ converge uniformly. It follows that the uniform-limit function $\tilde{f} = \lim f_i$ is in $C^m(U)$. Since $f_i \rightarrow f$ in $L^p(U)$ and $f_i \rightarrow \tilde{f}$ uniformly, we conclude that $\tilde{f} = f$ almost everywhere. Thus \tilde{f} tells how to redefine f on a set of measure 0 so as to be in $C^m(U)$. \square

3. Harmonic Functions

Let U be an open set in \mathbb{R}^N . The discussion will not be very interesting for $N = 1$, and we exclude that case. A function u in $C^2(U)$ is **harmonic** in U if $\Delta u = 0$ identically in U . Harmonic functions were introduced already in Chapter I and investigated in connection with certain boundary-value problems. In the present

section we examine properties of harmonic functions more generally. Harmonic functions in a half space, through their boundary values and the Poisson integral formula, become a tool in analysis for working with functions on the Euclidean boundary, and the behavior of harmonic functions on general open sets becomes a prototype for the behavior of solutions of further “elliptic” second-order partial differential equations.

Harmonic functions will be characterized shortly in terms of a certain mean-value property. To get at this characterization and its ramifications, we need the N -dimensional “Divergence Theorem” of Gauss for two special cases—a ball and a half space. The result for a ball will be formulated as in Lemma 3.13 below; we give a proof since this theorem was not treated in *Basic*. The argument for a half space is quite simple, and we will incorporate what we need into the proof of Proposition 3.15 below. For the case of a ball, recall⁶ that the change-of-variables formula $x = r\omega$, with $r \geq 0$ and $|\omega| = 1$, for transforming integrals in Cartesian coordinates for \mathbb{R}^N into spherical coordinates involves substituting $dx = r^{N-1} dr d\omega$, where $d\omega$ is a certain rotation-invariant measure on the unit sphere S^{N-1} that can be expressed in terms of $N - 1$ angular variables. The open ball of radius x_0 and radius r is denoted by $B(r; x_0)$, and its boundary is $\partial B(r; x_0)$.

Lemma 3.13. If F is a C^1 function in an open set on \mathbb{R}^N containing the closed ball $B(r; 0)^{\text{cl}}$ and if $1 \leq j \leq N$, then

$$\int_{x \in B(r; 0)} \frac{\partial F}{\partial x_j}(x_0 + x) dx = \int_{r\omega \in \partial B(r; 0)} x_j F(x_0 + r\omega) r^{N-2} d\omega.$$

REMARKS. The lemma is a special case of the **Divergence Theorem**, whose usual formula of is $\int_U \text{div } \mathbf{F} dx = \int_{\partial U} (\mathbf{F} \cdot \mathbf{n}) dS$, where U is a suitable bounded open set, $\partial U = U^{\text{cl}} - U$ is its boundary, \mathbf{n} is the outward-pointing unit normal, \mathbf{F} is a vector-valued C^1 function, and dS is surface area. In Lemma 3.13, U is specialized to the ball $B(r; 0)$, dS is the $(N - 1)$ -dimensional area measure $r^{N-1} d\omega$ on the surface $\partial B(r; 0)$ of the ball, \mathbf{F} is taken to be the product of F by the j^{th} standard basis vector e_j , and $e_j \cdot \mathbf{n}$ is $r^{-1} x_j$.

PROOF. Without loss of generality, we may take $j = 1$ and $x_0 = 0$. Write $x = (x_1, x')$, where $x' = (x_2, \dots, x_N)$, and write $\omega = (\omega_1, \omega')$ similarly. The left side in the displayed formula is equal to

$$\begin{aligned} \int_{|x'| \leq r} \int_{x_1 = -\sqrt{r^2 - |x'|^2}}^{\sqrt{r^2 - |x'|^2}} \frac{\partial F}{\partial x_1}(x_1, x') dx_1 dx' \\ = \int_{|x'| \leq r} [F(\sqrt{r^2 - |x'|^2}, x') - F(-\sqrt{r^2 - |x'|^2}, x')] dx'. \end{aligned}$$

⁶From Section VI.5 of *Basic*.

Thus the lemma will follow if it is proved that

$$\int_{|x'| \leq r} F(\sqrt{r^2 - |x'|^2}, x') dx' = \int_{|\omega|=1, \omega_1 \geq 0} x_1 F(r\omega) r^{N-2} d\omega \quad (*)$$

and

$$- \int_{|x'| \leq r} F(-\sqrt{r^2 - |x'|^2}, x') dx' = \int_{|\omega|=1, \omega_1 \leq 0} x_1 F(r\omega) r^{N-2} d\omega. \quad (**)$$

Let us use ordinary spherical coordinates for ω , with

$$\begin{pmatrix} r\omega_1 \\ \vdots \\ r\omega_N \end{pmatrix} = \begin{pmatrix} r \cos \theta_1 \\ r \sin \theta_1 \cos \theta_2 \\ \vdots \\ r \sin \theta_1 \cdots \sin \theta_{N-2} \cos \theta_{N-1} \\ r \sin \theta_1 \cdots \sin \theta_{N-2} \sin \theta_{N-1} \end{pmatrix}$$

and

$$d\omega = \sin^{N-2} \theta_1 \sin^{N-3} \theta_2 \cdots \sin \theta_{N-2} d\theta_1 \cdots d\theta_{N-1}.$$

The right side of (*) is equal to

$$\begin{aligned} & \int_{|\omega|=1, \omega_1 \geq 0} F(r\omega) \omega_1 r^{N-2} d\omega \\ &= \int_{\substack{0 \leq \theta_1 \leq \pi/2, \\ 0 \leq \theta_j \leq \pi \text{ for } 1 < j < N-1, \\ 0 \leq \theta_{N-1} \leq 2\pi}} F(r\omega) r^{N-1} \cos \theta_1 \sin^{N-2} \theta_1 \sin^{N-3} \theta_2 \cdots \sin \theta_{N-2} d\theta_1 \cdots d\theta_{N-1}, \end{aligned}$$

and we show that it equals the left side of (*) by carrying out for the left side of (*) the change of variables $x' \leftrightarrow (\theta_1, \dots, \theta_{N-1})$ given with r constant by

$$x' = \begin{pmatrix} x_2 \\ \vdots \\ x_N \end{pmatrix} = \begin{pmatrix} r \sin \theta_1 \cos \theta_2 \\ \vdots \\ r \sin \theta_1 \cdots \sin \theta_{N-2} \cos \theta_{N-1} \\ r \sin \theta_1 \cdots \sin \theta_{N-2} \sin \theta_{N-1} \end{pmatrix}.$$

The Jacobian matrix is the same as for the change to spherical coordinates $(r, \theta_2, \dots, \theta_{N-1})$ except that the first column has a factor $r \cos \theta_1$ instead of 1 and the other columns have an extra factor of $\sin \theta_1$. Consequently

$$dx' = r^{N-1} (|\cos \theta_1| \sin^{N-2} \theta_1) (\sin^{N-3} \theta_2 \cdots \sin \theta_{N-2}) d\theta_1 \cdots d\theta_{N-1}.$$

Therefore the measures match in the two transformed sides, the sets of integration for $(\theta_1, \dots, \theta_{N-1})$ are the same, and the integrands are the same because $\cos \theta_1 = |\cos \theta_1|$. This proves (*). For (**) we make the same computation but the interval of integration for θ_1 is $\pi/2 \leq \theta_1 \leq \pi$. To get a match, the minus sign is necessary because $\cos \theta_1 = -|\cos \theta_1|$. \square

Proposition 3.14 (Green's formula⁷ for a ball). Let B be an open ball in \mathbb{R}^N , let ∂B be its surface, and let $d\sigma$ be the surface-area measure of ∂B . If u and v are C^2 functions in an open set containing B^{cl} , then

$$\int_B (u \Delta v - v \Delta u) dx = \int_{\partial B} \left(u \frac{\partial v}{\partial \mathbf{n}} - v \frac{\partial u}{\partial \mathbf{n}} \right) d\sigma,$$

where $\mathbf{n} : \partial S \rightarrow \mathbb{R}^N$ is the outward-pointing unit normal vector.

PROOF. Apply Lemma 3.13 to $F = u \frac{\partial v}{\partial x_j}$ and then to $F = v \frac{\partial u}{\partial x_j}$, and subtract the results. Then sum on j . \square

Let Ω_{N-1} be the surface area $\int_{S^{N-1}} d\omega$ of the unit sphere in \mathbb{R}^N . A continuous function u on an open subset U of \mathbb{R}^N is said to have the **mean-value property** in U if the value of u at each point x in U equals the average value of u over each sphere centered at x and lying in U , i.e., if

$$u(x) = \frac{1}{\Omega_{N-1}} \int_{\omega \in S^{N-1}} u(x + t\omega) d\omega$$

for every x in U and for every positive t less than the distance from x to U^c .

The mean-value property over spheres implies a corresponding average-value property over balls. In fact, the volume $|B(t_0; 0)|$ of the ball $B(t_0; 0)$ is given by $\int_0^{t_0} \int_{S^{N-1}} t^{N-1} d\omega dt = N^{-1} t_0^N \int_{S^{N-1}} d\omega = N^{-1} t_0^N \Omega_{N-1}$. When the mean-value property over spheres is satisfied and t_0 is less than the distance from x to U^c , we can apply the operation $N t_0^{-N} \int_0^{t_0} (-) dt$ to both sides of the mean-value formula and obtain

$$u(x) = \frac{N t_0^{-N}}{\Omega_{N-1}} \int_0^{t_0} \int_{\omega \in S^{N-1}} u(x + t\omega) t^{N-1} d\omega dt = \frac{1}{|B(t_0; 0)|} \int_{B(t_0; 0)} u(x + y) dy.$$

Proposition 3.15 (Green's formula for a half space). Let H be the subset of $\mathbb{R}^N = \{(x', x_N) \mid x' \in \mathbb{R}^{N-1} \text{ and } x_N \in \mathbb{R}\}$ with $x_N > 0$. Suppose that u and v are C^2 functions on an open subset of \mathbb{R}^N containing the closure \overline{H} and that at least one of u and v is compactly supported. Then

$$\int_{x \in H} (u \Delta v - v \Delta u) dx = \int_{x' \in \mathbb{R}^{N-1}} \left(v \frac{\partial u}{\partial x_N} - u \frac{\partial v}{\partial x_N} \right) dx'.$$

PROOF. Suppose F is a C^1 function compactly supported on an open subset of \mathbb{R}^N containing \overline{H} . If $1 \leq j \leq N - 1$, then $\int_H \frac{\partial F}{\partial x_j} dx = 0$ since the integral with

⁷This formula is related to but distinct from the formula with the same name at the beginning of Section I.3.

respect to dx_j is the difference between two values of F and since these are 0 by the compactness of the support. For $j = N$, however, one of the boundary terms may fail to be 0, and the result is that $\int_H \frac{\partial F}{\partial x_N} dx = - \int_{\mathbb{R}^{N-1}} F(x') dx'$.

Apply the j^{th} of these formulas first to $F = u \frac{\partial v}{\partial x_j}$ and then to $F = v \frac{\partial u}{\partial x_j}$, sum the results on j , and subtract the two sums. The result is the formula of the proposition. \square

Theorem 3.16. Let U be an open set in \mathbb{R}^N , and let u be a continuous scalar-valued function on U . If u is harmonic on U , then u has the mean-value property on U . Conversely if u has the mean-value property on U , then u is in $C^\infty(U)$ and is harmonic on U .

PROOF. Suppose that u is harmonic on U . We prove that u has the mean-value property. It is enough to treat $x = 0$. Green's formula, as in Proposition 3.14, directly extends from balls to the difference of two balls.⁸ Thus we have

$$\int_E (u \Delta v - v \Delta u) dx = \int_{\partial E} \left(u \frac{\partial v}{\partial \mathbf{n}} - v \frac{\partial u}{\partial \mathbf{n}} \right) d\sigma \quad (*)$$

whenever E is a closed ball B_t of radius t contained in U or is the difference $B_t - (B_\epsilon)^\circ$ of two concentric balls with $\epsilon < t$. Taking $E = B_t$ and $v = 1$ in (*), we obtain

$$\int_{\partial B_t} \frac{\partial u}{\partial \mathbf{n}} d\sigma = 0. \quad (**)$$

Routine computation shows that the function given by

$$v(x) = \begin{cases} |x|^{-(N-2)} & \text{for } N > 2, \\ \log |x| & \text{for } N = 2, \end{cases}$$

is harmonic for $x \neq 0$ and has $\frac{\partial v}{\partial r}$ equal to a nonzero multiple of $|x|^{-(N-1)}$, r being the spherical coordinate radius $|x|$. If we apply (*) to this v and our harmonic u when $E = B_t - (B_\epsilon)^\circ$, we obtain

$$\int_{\partial(B_t - (B_\epsilon)^\circ)} \left(u \frac{\partial v}{\partial \mathbf{n}} - v \frac{\partial u}{\partial \mathbf{n}} \right) d\sigma = 0.$$

Since v depends only on $|x|$, (**) shows that the second term of the integrand yields 0. Thus this formula becomes

$$\int_{\partial(B_t - (B_\epsilon)^\circ)} u \frac{\partial v}{\partial \mathbf{n}} d\sigma = 0.$$

⁸For the extended result, suppose that the balls have radii $r_1 < r_2$. Then u and v are defined from radius $r_1 - \epsilon$ to $r_2 + \epsilon$ for some $\epsilon > 0$. We can adjust u and v by multiplying by a suitable smooth function that is identically 1 for radius $\geq r_1 - \frac{1}{3}\epsilon$ and identically 0 for radius $\leq r_1 - \frac{2}{3}\epsilon$, and then u and v will extend as smooth functions for radius $< r_2 + \epsilon$. Consequently Proposition 3.14 will apply on each ball to the adjusted functions, and subtraction of the results gives the desired version of Green's formula.

The normal vector for the inner sphere points toward the center. Hence we can rewrite our equality as

$$\int_{|x|=\epsilon} u \frac{\partial v}{\partial r} d\sigma = \int_{|x|=t} u \frac{\partial v}{\partial r} d\sigma.$$

Since $\frac{\partial v}{\partial r} = c|x|^{-(N-1)}$ with $c \neq 0$, we obtain

$$\epsilon^{-(N-1)} \int_{|x|=\epsilon} u d\sigma = t^{-(N-1)} \int_{|x|=t} u d\sigma.$$

On the left side, $d\sigma = \epsilon^{N-1} d\omega$, while on the right side, $d\sigma = t^{N-1} d\omega$. Therefore

$$\int_{|\omega|=1} u(\epsilon\omega) d\omega = \int_{|\omega|=1} u(t\omega) d\omega$$

whenever $0 < \epsilon < t$ and B_t is contained in U . Dividing by Ω_{N-1} , letting ϵ decrease to 0, and using the continuity of u , we see that $u(0) = \int_{\omega \in S^{N-1}} u(t\omega) d\omega$. Thus u has the mean-value property.

For the converse direction suppose initially that u is in $C^2(U)$. Define

$$m_t(u)(x) = \Omega_{N-1}^{-1} \int_{|\omega|=1} u(x + t\omega) d\omega$$

whenever x is in U and t is a positive number less than the distance of x to U^c . With x fixed, the function $m_t(u)(x)$ has two continuous derivatives. We shall show that

$$\frac{d^2}{dt^2} m_t(u)(x) \Big|_{t=0} = N^{-1} \Delta u(x), \quad (\dagger)$$

the derivatives being understood to be one-sided derivatives as t decreases to 0. If u is assumed to have the mean-value property, $m_t(u)(x)$ is constant in t , and we can conclude from (\dagger) that $\Delta u(x) = 0$. The computation of $\frac{d^2}{dt^2} m_t(u)(x)$ is

$$\begin{aligned} m_t(u)(x) &= \Omega_{N-1}^{-1} \int_{|\omega|=1} u(x_1 + t\omega_1, \dots, x_N + t\omega_N) d\omega, \\ \frac{d}{dt} m_t(u)(x) &= \Omega_{N-1}^{-1} \int_{|\omega|=1} \sum_{j=1}^N \omega_j D_j u(x + t\omega) d\omega, \\ \frac{d^2}{dt^2} m_t(u)(x) &= \Omega_{N-1}^{-1} \int_{|\omega|=1} \sum_{j,k=1}^N \omega_j \omega_k D_j D_k u(x + t\omega) d\omega. \end{aligned}$$

Letting t decrease to 0, we obtain

$$\frac{d^2}{dt^2} m_t(u)(x) \Big|_{t=0} = \Omega_{N-1}^{-1} \sum_{j,k=1}^N D_j D_k u(x) \int_{|\omega|=1} \omega_j \omega_k d\omega.$$

If $j \neq k$, then $\int_{|\omega|=1} \omega_j \omega_k d\omega = 0$ since the integrand is an odd function of the j^{th} variable taken over a set symmetric about 0. The integral $\int_{|\omega|=1} \omega_j^2 d\omega$ is

independent of j and has the property that N times it is equal to $\int_{|\omega|=1} |\omega|^2 d\omega = \int_{|\omega|=1} d\omega = \Omega_{N-1}$. Thus $\int_{|\omega|=1} \omega_j^2 d\omega = N^{-1} \Omega_{N-1}$, and

$$\frac{d^2}{dt^2} m_t(u)(x) \Big|_{t=0} = N^{-1} \sum_{j=1}^N D_j^2 u(x) = N^{-1} \Delta u(x).$$

This proves (†) and completes the argument that a C^2 function in U with the mean-value property is harmonic.

Finally suppose that u has the mean-value property and is assumed to be merely continuous. Proposition 3.5e allows us to choose a function $\varphi \geq 0$ in $C_{\text{com}}^\infty(\mathbb{R}^N)$ with $\varphi(x) = \varphi_0(|x|)$, $\int_{\mathbb{R}^N} \varphi(x) dx = 1$, and $\varphi(x) = 0$ for $|x| \geq 1$. Put $\varphi_\varepsilon(x) = \varepsilon^{-N} \varphi(\varepsilon^{-1}x)$, and define $u_\varepsilon(x) = \int_{\mathbb{R}^N} u(x-y) \varphi_\varepsilon(y) dy$ in the open set $U_\varepsilon = \{x \in U \mid D(x, U^c) > \varepsilon\}$. Proposition 3.5c shows that u_ε is in $C^\infty(U_\varepsilon)$, and the mean-value property of u , in combination with the radial nature of φ_ε as expressed by the equality $\varphi_\varepsilon(t\omega) = \varphi_\varepsilon(te_1)$, forces $u_\varepsilon(x) = u(x)$ for all x in U_ε :

$$\begin{aligned} u_\varepsilon(x) &= \int_{t=0}^\varepsilon \int_{|\omega|=1} u(x-t\omega) \varphi_\varepsilon(t\omega) t^{N-1} d\omega dt \\ &= \int_{t=0}^\varepsilon \Omega_{N-1} u(x) \varphi_\varepsilon(te_1) t^{N-1} dt \\ &= u(x) \int_{\mathbb{R}^N} \varphi_\varepsilon(y) dy = u(x). \end{aligned}$$

Since ε is arbitrary, u is in $C^\infty(U)$. The function u has now been shown to be in $C^2(U)$, and it is assumed to have the mean-value property. Therefore the previous case shows that it is harmonic. \square

Corollary 3.17. If u is harmonic on an open subset U of \mathbb{R}^N , then u is in $C^\infty(U)$.

PROOF. This follows by using both directions of Theorem 3.16. \square

A sequence of functions $\{u_n\}$ on a locally compact Hausdorff space X is said to converge **uniformly on compact subsets** of X if $\lim u_n = u$ pointwise on X and if for each compact subset K of X , the convergence is uniform on K . For example the sequence $\{x^n\}$ converges to the 0 function on $(0, 1)$ uniformly on compact subsets.

Corollary 3.18. If $\{u_n\}$ is a sequence of harmonic functions on an open subset U of \mathbb{R}^N and if $\{u_n\}$ converges uniformly on compact subsets to u , then u is harmonic on U .

PROOF. About any point of U is a compact neighborhood lying in U , and the convergence is uniform on that neighborhood. Therefore u is continuous. Each integration needed for the mean-value property occurs on a compact subset

of U , and the uniform convergence allows us to interchange limit and integral. Therefore the mean-value property for each u_n , valid because of one direction of Theorem 3.16, implies the mean-value property for u . Hence u is harmonic by the converse direction of Theorem 3.16. \square

Suppose that U is open in \mathbb{R}^N and that u is harmonic on U . If B is an open ball in U , then $\int_U u \Delta \psi \, dx = 0$ for all $\psi \in C_{\text{com}}^\infty(B)$ by Green's formula (Proposition 3.14), since ψ and $\frac{\partial \psi}{\partial \mathbf{n}}$ are both identically 0 on the boundary of B . We shall use a smooth partition of unity to show that $\int_U u \Delta \psi \, dx$ is therefore 0 for all $\psi \in C_{\text{com}}^\infty(U)$. Corollary 3.19 below provides a converse; we shall use the converse in a crucial way in Corollary 3.23 below.

The argument to construct the partition of unity goes as follows. To each point of $K = \text{support}(\psi)$, we can associate an open ball centered at that point whose closure is contained in U . As the point varies, these open balls cover K , and we extract a finite subcover $\{U_1, \dots, U_k\}$. Lemma 3.15b of *Basic* constructs an open cover $\{W_1, \dots, W_k\}$ of K such that W_i^{cl} is a compact subset of U_i for each i . Now we argue as in the proof of Proposition 3.14 of *Basic*. A second application of Lemma 3.15b of *Basic* gives an open cover $\{V_1, \dots, V_k\}$ of K such that V_i^{cl} is compact and $V_i^{\text{cl}} \subseteq W_i$ for each i . Proposition 3.5f constructs a smooth function $g_i \geq 0$ that is 1 on V_i^{cl} and is 0 off W_i . Then $g = \sum_{i=1}^k g_i$ is smooth and ≥ 0 on \mathbb{R}^N and is > 0 everywhere on K . A second application of Proposition 3.5f produces a smooth function $h \geq 0$ on \mathbb{R}^N that is 1 on the set where g is 0 and is 0 on K . Then $g+h$ is everywhere positive on \mathbb{R}^N , and the functions $\varphi_i = g_i/(g+h)$ form the smooth partition of unity that we shall use.

To apply the partition of unity, we write $\psi = \sum_i \varphi_i \psi$. Then each term $\varphi_i \psi$ is smooth and compactly supported in an open ball whose closure is contained in U . Consequently we have $\int_U u \Delta(\varphi_i \psi) \, dx = 0$ for each i . Summing on i , we obtain $\int_U u \Delta \psi \, dx = 0$, which was what was being asserted.

Corollary 3.19. Suppose that U is open in \mathbb{R}^N , that u is continuous on U , and that $\int_U u \Delta \psi \, dx = 0$ for all $\psi \in C_{\text{com}}^\infty(U)$. Then u is harmonic on U .

PROOF. Let B be an open ball of radius r with closure contained in U , fix $\varepsilon > 0$ so as to be $< r$, and let B_ε be the open ball of radius $r - \varepsilon$ with the same center as B . Construct φ_ε as in the proof of Theorem 3.16, and let $u_\varepsilon = u * \varphi_\varepsilon$. Suppose that ψ is in $C_{\text{com}}^\infty(B_\varepsilon)$. For t and x in \mathbb{R}^N with $|t| \leq \varepsilon$, define $\psi_t(x) = \psi(t+x)$. Since ψ is supported in B_ε , ψ_t is supported in B , and therefore

$$\int_B u(x-t) \Delta \psi_t(x) \, dx = \int_B u(x) \Delta \psi(x+t) \, dx = \int_B u \Delta \psi_t \, dx = 0,$$

the last equality holding by the hypothesis. Multiplying by $\varphi_\varepsilon(t)$, integrating for $|t| \leq \varepsilon$, and interchanging integrals, we obtain

$$0 = \int_B \int_{\mathbb{R}^N} u(x-t) \varphi_\varepsilon(t) \Delta \psi_t(x) \, dt \, dx = \int_B u_\varepsilon(x) \Delta \psi(x) \, dx.$$

Since ψ vanishes identically near the boundary of B , this identity and Green's formula (Proposition 3.14) together yield $\int_B \psi(x) \Delta u_\varepsilon(x) dx = 0$ for all ψ in $C_{\text{com}}^\infty(B_\varepsilon)$. Application of Corollary 3.6a allows us to extend this conclusion to all ψ in $C_{\text{com}}(B_\varepsilon)$, and then the uniqueness in the Riesz Representation Theorem shows that we must have $\Delta u_\varepsilon(x) = 0$ for all x in B_ε . As ε decreases to 0, u_ε tends to u uniformly on compact sets. By Corollary 3.18, u is harmonic in B . Since the ball B is arbitrary in U , u is harmonic in U . \square

Corollary 3.20. Let U be a connected open set in \mathbb{R}^N . If u is harmonic in U and $|u|$ attains a maximum somewhere in U , then u is constant in U .

PROOF. Suppose that $|u|$ attains a maximum at x_0 . Multiplying u by a suitable constant $e^{i\theta}$, we may assume that $u(x_0) = M > 0$. The subset E of U where $u(x)$ equals M is closed and nonempty. It is enough to prove that E is open. Let x_1 be in E , and choose an open ball B centered at x_1 , say of some radius $r > 0$, that lies in U . We show that B lies in E . For $0 < t < r$, Theorem 3.16 says that u has the mean-value property

$$\Omega_{N-1}^{-1} \int_{S^{N-1}} u(x_1 + t\omega) d\omega = u(x_1) = M.$$

Arguing by contradiction, suppose that $u(x_1 + t_0\omega_0) \neq u(x_1)$ for some $t_0\omega_0$ with $0 < t_0 < r$. Then $\text{Re } u(x_1 + t_0\omega_0) < M - \epsilon$ for some $\epsilon > 0$, and continuity produces a nonempty open set S in the sphere S^{N-1} such that $\text{Re } u(x_1 + t_0\omega) < M - \epsilon$ for ω in S . If σ is the name of the measure on S^{N-1} , then we have

$$\begin{aligned} M\Omega_{N-1} &= \text{Re} \left(\int_{S^{N-1}} u(x_1 + t\omega) d\omega \right) \\ &= \int_S \text{Re } u(x_1 + t\omega) d\omega + \int_{S^{N-1}-S} \text{Re } u(x_1 + t\omega) d\omega \\ &\leq \int_S (M - \epsilon) d\omega + \int_{S^{N-1}-S} M d\omega \\ &= (M - \epsilon)\sigma(S) + M\sigma(S^{N-1} - S) \\ &= M\Omega_{N-1} - \epsilon\sigma(S), \end{aligned}$$

and we have arrived at a contradiction since $\sigma(S) > 0$. \square

Corollary 3.21. Let U be a bounded open subset of \mathbb{R}^N , and let ∂U be its boundary. If u is harmonic in U and u is continuous on U^{cl} , then $\sup_{x \in U} |u(x)| = \max_{x \in \partial U} |u(x)|$.

PROOF. Since u is continuous and U^{cl} is compact, $|u|$ assumes its maximum M somewhere on U^{cl} . If $|u(x_0)| = M$ for some x_0 in U , then Corollary 3.20 shows that u is constant on the component of U to which x_0 belongs. The closure of that component cannot equal that component since \mathbb{R}^N is connected. Thus the closure of that component contains a point of ∂U , and $|u|$ must equal M at that point of ∂U . Consequently $\sup_{x \in U} |u(x)| \leq \max_{x \in \partial U} |u(x)|$. Since every point of ∂U is the limit of a sequence of points in U , the reverse inequality is valid as well, and the corollary follows. \square

Corollary 3.22 (Liouville). Any bounded harmonic function on \mathbb{R}^N is constant.

REMARKS. The best-known result of Liouville of this kind is one from complex analysis—that a bounded function analytic on all of \mathbb{C} is constant. This complex-analysis result is actually a consequence of Corollary 3.22 because the real and imaginary parts of a bounded analytic function on \mathbb{C} are bounded harmonic functions on \mathbb{R}^2 .

PROOF. Suppose that u is harmonic on \mathbb{R}^N with $|u(x)| \leq M$. Let x_1 and x_2 be distinct points of \mathbb{R}^N , and let $R > 0$. Since u has the mean-value property over spheres by Theorem 3.16, u equals its average value over balls. Hence $u(x_1) = |B(R; 0)|^{-1} \int_{B(R; x_1)} u(x) dx$ and $u(x_2) = |B(R; 0)|^{-1} \int_{B(R; x_2)} u(x) dx$. Subtraction gives

$$\begin{aligned} u(x_1) - u(x_2) &= |B(R; 0)|^{-1} \left(\int_{B(R; x_1)} u(x) dx - \int_{B(R; x_2)} u(x) dx \right) \\ &= |B(R; 0)|^{-1} \left(\int_{B(R; x_1) - B(R; x_2)} u(x) dx - \int_{B(R; x_2) - B(R; x_1)} u(x) dx \right). \end{aligned}$$

Therefore

$$|u(x_1) - u(x_2)| \leq |B(R; 0)|^{-1} \int_{B(R; x_1) \Delta B(R; x_2)} |u(x)| dx,$$

where $B(R; x_1) \Delta B(R; x_2)$ is the symmetric difference $(B(R; x_1) - B(R; x_2)) \cup (B(R; x_2) - B(R; x_1))$. Hence

$$|u(x_1) - u(x_2)| \leq \frac{M |B(R; x_1) \Delta B(R; x_2)|}{|B(R; 0)|} = \frac{MR^N |B(1; x_1/R) \Delta B(1; x_2/R)|}{R^N |B(1; 0)|}.$$

The right side is $|B(1; x_1/R) \Delta B(1; x_2/R)|$, apart from a constant factor, and the sets $B(1; x_1/R) \Delta B(1; x_2/R)$ decrease and have empty intersection as R tends to infinity. By complete additivity of Lebesgue measure, the measure of the symmetric difference tends to 0. We conclude that $u(x_1) = u(x_2)$. Therefore u is constant. \square

In the final two corollaries let \mathbb{R}_+^{N+1} be the open half space of points (x, t) in \mathbb{R}^{N+1} such that x is in \mathbb{R}^N and $t > 0$.

Corollary 3.23 (Schwarz Reflection Principle). Suppose that $u(x, t)$ is harmonic in \mathbb{R}_+^{N+1} , that u is continuous on $(\mathbb{R}_+^{N+1})^{\text{cl}}$, and that $u(x, 0) = 0$ for all x . Then the definition $u(x, -t) = -u(x, t)$ for $t > 0$ extends u to a harmonic function on all of \mathbb{R}^{N+1} .

PROOF. Define

$$w(x, t) = \begin{cases} u(x, t) & \text{for } t \geq 0, \\ -u(x, -t) & \text{for } t \leq 0. \end{cases}$$

The function w is continuous. We shall show that $\int_{\mathbb{R}^N} w \Delta \psi \, dx = 0$ for all $\psi \in C_{\text{com}}^\infty(\mathbb{R}^{N+1})$, and then Corollary 3.19 shows that w is harmonic. Write ψ as the sum of functions even and odd in the variable t . Since w is odd in t , the contribution to $\int_{\mathbb{R}^N} w \Delta \psi \, dx$ from the even part of ψ is 0. We may thus assume that ψ is odd in t .

For $\varepsilon > 0$, let $R_\varepsilon = \{(x, t) \mid t > \varepsilon\}$. It is enough to show that $\int_{R_\varepsilon} u \Delta \psi \, dx \, dt$ has limit 0 as ε decreases to 0 since $\int_{\mathbb{R}^{N+1}} w \Delta \psi \, dx \, dt$ is twice this limit. We apply Green's formula for a half space (Proposition 3.15) with $v = \psi$ on the set $R_\varepsilon \subseteq \mathbb{R}^{N+1}$ except for one detail: to get the hypothesis of compact support to be satisfied, we temporarily multiply ψ by a smooth function that is identically 1 for $t \geq \varepsilon$ and is identically 0 for $t \leq \frac{1}{2}\varepsilon$. Since u is harmonic in R_ε , the result is that

$$-\int_{R_\varepsilon} u \Delta \psi \, dx \, dt = \int_{R_\varepsilon} (\psi \Delta u - u \Delta \psi) \, dx \, dt = \int_{\{(x,t) \mid t=\varepsilon\}} \left(u \frac{\partial \psi}{\partial t} - \psi \frac{\partial u}{\partial t} \right) dx.$$

On the right side, $\lim_{\varepsilon \downarrow 0} \int_{\{(x,t) \mid t=\varepsilon\}} u \frac{\partial \psi}{\partial t} \, dx = 0$ since $u(\cdot, \varepsilon)$ tends uniformly to 0 on the relevant compact set of x 's in \mathbb{R}^N .

Thus it is enough to prove that $\lim_{\varepsilon \downarrow 0} \int_{\{(x,t) \mid t=\varepsilon\}} \psi \frac{\partial u}{\partial t} \, dx = 0$. Since $\psi(x, t)$ is of class C^2 , is odd in x , and is compactly supported, we have $|\psi(x, t)| \leq Ct$ uniformly in x for small positive t . Thus it is enough to prove that

$$\lim_{t \downarrow 0} \left| t \frac{\partial u}{\partial t}(x, t) \right| = 0 \quad (*)$$

uniformly on compact subsets of \mathbb{R}^N .

To prove (*), let φ be a function as in Proposition 3.5e, and let $\varphi_\varepsilon(x, t) = \varepsilon^{-(N+1)} \varphi(\varepsilon^{-1}(x, t))$. Fix x_0 in \mathbb{R}^N , and define $X_0 = (x_0, t_0)$ and $X = (x_0, t)$. If $|X - X_0| < \frac{1}{3}t_0$, then the mean-value property of u in \mathbb{R}_+^{N+1} gives $u(X) = (u * \varphi_{\frac{1}{3}t_0})(X)$. Hence we have

$$\begin{aligned} \frac{\partial u}{\partial t}(X) &= \frac{\partial}{\partial t} \int_{\mathbb{R}^{N+1}} \varphi_{\frac{1}{3}t_0}(X - Y) u(Y) \, dY \\ &= \int_{\mathbb{R}^{N+1}} \frac{\partial}{\partial t} \left[\left(\frac{1}{3}t_0\right)^{-(N+1)} \varphi\left(\left(\frac{1}{3}t_0\right)^{-1}(X - Y)\right) \right] u(Y) \, dY. \end{aligned}$$

In the computation of the partial derivative on the right side, the variable t appears as the last coordinate of X . Therefore this expression is equal to

$$\left(\frac{1}{3}t_0\right)^{-1} \int_{\mathbb{R}^{N+1}} \left(\frac{1}{3}t_0\right)^{-(N+1)} \frac{\partial \varphi}{\partial t} \left(\left(\frac{1}{3}t_0\right)^{-1}(X - Y) \right) u(Y) \, dY.$$

Changing variables in the integration by a dilation in Y shows that this expression is equal also to

$$\left(\frac{1}{3}t_0\right)^{-1} \int_{\mathbb{R}^{N+1}} \frac{\partial \varphi}{\partial t} \left(\left(\frac{1}{3}t_0\right)^{-1} X - Y\right) u\left(\frac{1}{3}t_0 Y\right) dY.$$

If we write $Y = (y, s)$ and take absolute values, we obtain

$$\left| \frac{\partial u}{\partial t}(x_0, t) \right| \leq 3t_0^{-1} \left\| \frac{\partial \varphi}{\partial t} \right\|_1 \sup_{\substack{|s-t_0| < 2t_0/3, \\ Y \text{ near } X_0}} |u(Y)|.$$

The required behavior of $t \frac{\partial u}{\partial t}$ follows from this estimate. \square

Corollary 3.24. Suppose that $u(x, t)$ is harmonic in \mathbb{R}_+^{N+1} , that u is continuous on $(\mathbb{R}_+^{N+1})^{\text{cl}}$, and that $u(x, 0) = 0$ for all x . If u is bounded, then u is identically 0.

REMARK. Without the assumption of boundedness, the function $u(x, t) = t$ is a counterexample.

PROOF. Corollary 3.23 shows that u extends to a bounded harmonic function on all of \mathbb{R}^{N+1} , and Corollary 3.22 shows that the extended function is constant, hence identically 0. \square

4. \mathcal{H}^p Theory

As was said at the beginning of Section 3, harmonic functions in a half space, through their boundary values and the Poisson integral formula, become a tool in analysis for working with functions on the Euclidean boundary. The Poisson integral formula, which was introduced in Chapters VIII and IX of *Basic*, generates harmonic functions from boundary values.

The details are as follows. Let \mathbb{R}_+^{N+1} be the open half space of pairs (x, t) in \mathbb{R}^{N+1} with $x \in \mathbb{R}^N$ and with $t > 0$ in \mathbb{R}^1 . We view the boundary $\{(x, 0) \mid x \in \mathbb{R}^N\}$ as \mathbb{R}^N . The function

$$P(x, t) = P_t(x) = \frac{c_N t}{(t^2 + |x|^2)^{\frac{1}{2}(N+1)}},$$

for $t > 0$, with $c_N = \pi^{-\frac{1}{2}(N+1)} \Gamma\left(\frac{N+1}{2}\right)$, is called the **Poisson kernel** for \mathbb{R}_+^{N+1} . The **Poisson integral formula** for \mathbb{R}_+^{N+1} is $u(x, t) = (P_t * f)(x)$, where f is any given function in $L^p(\mathbb{R}^N)$ and $1 \leq p \leq \infty$, and the function u is called the **Poisson integral** of f .

If f is in L^p , then u is harmonic on \mathbb{R}_+^{N+1} , $u(\cdot, t)$ is in L^p for each $t > 0$, and $\|u(\cdot, t)\|_p \leq \|f\|_p$. For $1 \leq p < \infty$, $\lim_{t \downarrow 0} u(\cdot, t) = f$ in the norm topology of L^p , while for $p = \infty$, $\lim_{t \downarrow 0} u(\cdot, t) = f$ in the weak-star topology of L^∞ against L^1 . In both cases, $\lim_{t \downarrow 0} \|u(\cdot, t)\|_p = \|f\|_p$, and $\lim_{t \downarrow 0} u(x, t) = f(x)$ a.e.; this latter result is known as **Fatou's Theorem**. When $p = \infty$, the a.e. convergence occurs at any point where f is continuous, and the pointwise convergence is uniform on any subset of \mathbb{R}^N where f is uniformly continuous.

The L^p theory for $p = 1$ extends from integrable functions to the Banach space $M(\mathbb{R}^N)$ of finite complex Borel measures. Specifically if ν is a finite complex Borel measure on \mathbb{R}^N , then the Poisson integral of ν is defined to be the function $u(x, t) = (P_t * \mu)(x) = \int_{\mathbb{R}^N} P_t(x - y) d\nu(y)$. Then u is harmonic on \mathbb{R}_+^{N+1} , $\|u(\cdot, t)\|_1 \leq \|\nu\|$ for each $t > 0$, $\lim_{t \downarrow 0} u(\cdot, t) = \nu$ in the weak-star topology of $M(\mathbb{R}^N)$ against $C_{\text{com}}(\mathbb{R}^N)$, and $\lim_{t \downarrow 0} \|u(\cdot, t)\|_1 = \|\mu\|$.

The new topic for this section is a converse to the above considerations. For $1 \leq p \leq \infty$, we define $\mathcal{H}^p(\mathbb{R}_+^{N+1})$ to be the vector space of functions $u(x, t)$ on \mathbb{R}_+^{N+1} such that

- (i) $u(x, t)$ is harmonic on \mathbb{R}_+^{N+1} ,
- (ii) $\sup_{t>0} \|u(\cdot, t)\|_p < \infty$.

With $\|u\|_{\mathcal{H}^p}$ defined as $\sup_{t>0} \|u(\cdot, t)\|_p$, the vector space $\mathcal{H}^p(\mathbb{R}_+^{N+1})$ is a normed linear space. If f is in $L^p(\mathbb{R}^N)$, then the facts about the Poisson integral formula show that the Poisson integral of f is in $\mathcal{H}^p(\mathbb{R}_+^{N+1})$ and its $\mathcal{H}^p(\mathbb{R}_+^{N+1})$ norm matches the $L^p(\mathbb{R}^N)$ norm of f . For $p = 1$, we readily produce further examples. Specifically if ν is any member of $M(\mathbb{R}^N)$, then the Poisson integral of ν is in $\mathcal{H}^1(\mathbb{R}_+^{N+1})$, with the $\mathcal{H}^1(\mathbb{R}_+^{N+1})$ norm matching the $M(\mathbb{R}^N)$ norm. The theorem of this section will say that there are no other examples.

The members of $\mathcal{H}^\infty(\mathbb{R}_+^{N+1})$ are exactly the bounded harmonic functions in the half space \mathbb{R}_+^{N+1} , and the tool for obtaining an L^∞ function on \mathbb{R}^N from this harmonic function is the preliminary form of Alaoglu's Theorem proved in *Basic*:⁹ any norm-bounded sequence in the dual of a separable normed linear space has a weak-star convergent subsequence.¹⁰ We shall use Corollary 3.24 to see that the harmonic function has to be the Poisson integral of this L^∞ function.

Theorem 3.25. If $1 < p \leq \infty$, then any harmonic function in $\mathcal{H}^p(\mathbb{R}_+^{N+1})$ is the Poisson integral of a function in $L^p(\mathbb{R}^N)$. For $p = 1$, any harmonic function in $\mathcal{H}^1(\mathbb{R}_+^{N+1})$ is the Poisson integral of a finite complex measure in $M(\mathbb{R}^N)$.

PROOF. We begin by proving that $u(x, t)$ is bounded for $t \geq t_0$. For this step we may assume that $p < \infty$. Theorem 3.16 shows that u has the mean-value

⁹Theorem 5.58 of *Basic*.

¹⁰The full-fledged version of Alaoglu's Theorem will be stated and proved in Chapter IV.

property. We know as a consequence that if B denotes the ball with center (x, t) and radius $\frac{1}{2}t_0$, then the value of u at (x, t) equals the average value over B :

$$u(x, t) = \frac{1}{|B|} \int_B u(y, s) dy ds.$$

Since the measure $|B|^{-1} dy ds$ on B has total mass 1, Hölder's inequality gives

$$\begin{aligned} |u(x, t)|^p &\leq \frac{1}{|B|} \int_B |u(y, s)|^p dy ds \\ &\leq \frac{1}{|B|} \int_{|s-t| \leq \frac{1}{2}t_0} \int_{y \in \mathbb{R}^N} |u(y, s)|^p dy ds \\ &\leq [(\frac{1}{2}t_0)^{N+1} \Omega_N]^{-1} (N+1)t_0 \|u\|_{\mathcal{H}^p}^p, \end{aligned}$$

and the boundedness is proved.

For each positive integer k , define $f_k(x) = u(x, 1/k)$ and $w(x, t) = (P_t * f_k)(x)$. Then the function $w_k(x, t) - u(x, t + 1/k)$ is

- (i) harmonic in (x, t) for $t > 0$ since w_k and any translate of u are harmonic,
- (ii) bounded as a function of (x, t) for $t \geq 0$ since $u(x, t + 1/k)$ is bounded for $t \geq 0$, according to the previous paragraph, and since w_k is the Poisson integral of the bounded function f_k ,
- (iii) continuous in (x, t) for $t \geq 0$ since $u(x, t + 1/k)$ and $w_k(x, t)$ both have this property, the latter because f_k is continuous and bounded.

By Corollary 3.24, $w_k(x, t) - u(x, t + 1/k) = 0$. That is,

$$u(x, t + 1/k) = \int_{\mathbb{R}^N} P_t(x - y) f_k(y) dy.$$

Now suppose $p > 1$, so that L^p is the dual space to $L^{p'}$ if $p^{-1} + p'^{-1} = 1$. Since u is in \mathcal{H}^p , $\|f_k\|_p \leq M$ for the constant $M = \|u\|_{\mathcal{H}^p}$. By the preliminary form of Alaoglu's Theorem, there exists a subsequence $\{f_{k_j}\}$ of $\{f_k\}$ that is weak-star convergent to some function f in $L^{p'}$. Since for each fixed t , P_t is in $L^1 \cap L^\infty$ and hence is in $L^{p'}$, each (x, t) has the property that

$$u(x, t + 1/k_j) = \int_{\mathbb{R}^N} P_t(x - y) f_{k_j}(y) dy \rightarrow \int_{\mathbb{R}^N} P_t(x - y) f(y) dy.$$

But $u(x, t + 1/k_j) \rightarrow u(x, t)$ by continuity of u . We conclude that $u(x, t) = \int_{\mathbb{R}^N} P_t(x - y) f(y) dy$.

This proves the theorem for $p > 1$. If $p = 1$, the above argument falls short of constructing a function f in L^1 since L^1 is not the dual of L^∞ . Instead, we treat f_k as a complex measure $f_k(x) dx$. The norm of $f_k(x) dx$ in $M(\mathbb{R}^N)$ equals $\|f_k\|_1$, and thus the norms of the complex measures $f_k(x) dx$ are bounded. The space $M(\mathbb{R}^N)$ is the dual of $C_{\text{com}}(\mathbb{R}^N)$ and hence also of its uniform closure, which is the Banach space $C_0(\mathbb{R}^N)$ of continuous functions on \mathbb{R}^N vanishing at infinity. Let $\{f_{k_j}(x) dx\}$ be a weak-star convergent subsequence of $\{f_k(x) dx\}$, with limit ν in $M(\mathbb{R}^N)$. Since each function $y \mapsto P_t(x - y)$ is in $C_0(\mathbb{R}^N)$, we have $\lim_k \int_{\mathbb{R}^N} P_t(x - y) f_{k_j}(y) dy = \int_{\mathbb{R}^N} P_t(x - y) d\nu(y)$. This completes the proof. \square

For $N = 1$, every analytic function in the upper half plane \mathbb{R}_+^2 is automatically harmonic, and one can ask for a characterization of the subspace of analytic members of $\mathcal{H}^p(\mathbb{R}_+^2)$. Aspects of the corresponding theory are discussed in Problems 13–20 at the end of the chapter.

5. Calderón–Zygmund Theorem

The Calderón–Zygmund Theorem asserts the boundedness of certain kinds of important operators on $L^p(\mathbb{R}^N)$ for $1 < p < \infty$. It is an N -dimensional generalization of the theorem giving the boundedness of the Hilbert transform, which was proved in Chapters VIII and IX of *Basic*. We state and prove the Calderón–Zygmund Theorem in this section, and we give some applications to partial differential equations in the next section.

Theorem 3.26 (Calderón–Zygmund Theorem). Let $K(x)$ be a C^1 function on $\mathbb{R}^N - \{0\}$ homogeneous¹¹ of degree 0 with mean value 0 over the unit sphere, i.e., with

$$\int_{S^{N-1}} K(\omega) d\omega = 0.$$

For each $\varepsilon > 0$, define

$$T_\varepsilon f(x) = \int_{|t| \geq \varepsilon} \frac{K(t)}{|t|^N} f(x - t) dt$$

whenever $1 < p < \infty$ and f is in $L^p(\mathbb{R}^N)$. Then

- (a) $\|T_\varepsilon f\|_p \leq A_p \|f\|_p$ for a constant A_p independent of ε and f ,
- (b) $\lim_{\varepsilon \downarrow 0} T_\varepsilon f = Tf$ exists as an L^p limit,
- (c) $\|Tf\|_p \leq A_p \|f\|_p$ for a constant A_p independent of f .

REMARKS. If $1 \leq p < \infty$ and if p' is the dual index to p , then the function equal to $K(t)/|t|^N$ for $|t| \geq \varepsilon$ and equal to 0 for $|t| < \varepsilon$ is in $L^{p'}$. Therefore, for each such p , $T_\varepsilon f$ is the convolution of an $L^{p'}$ function and an L^p function and is a well-defined bounded uniformly continuous function. In proving the theorem, we shall use less about $K(x)$ than the assumed C^1 condition on $\mathbb{R}^N - \{0\}$ but more than continuity. The precise condition that we shall use is that $|K(x) - K(y)| \leq \psi(|x - y|)$ on S^{N-1} for a nondecreasing function $\psi(\delta)$ of one variable that satisfies $\int_0^1 \frac{\psi(\delta)}{\delta} d\delta < \infty$.

¹¹A function F of several variables is **homogeneous of degree m** if $F(rx) = r^m F(x)$ for all $r > 0$ and all $x \neq 0$.

The main steps in the proof are to show that the operator T_1 equal to T_ε for $\varepsilon = 1$ is bounded on L^2 and is of weak-type $(1, 1)$ in the sense that $|\{x \mid |(T_1 f)(x) > \xi\}| \leq C \|f\|_1 / \xi$. The remainder of the argument is qualitatively similar to the argument with the Hilbert transform, not really involving any new ideas. We handle matters in the following order: First we prove as Lemma 3.27 two facts needed in the L^2 analysis, second we give the proof of the boundedness of T_1 on L^2 , third we establish in Lemmas 3.28 and 3.29 a weak-type $(1, 1)$ result for a wide class of operators, and fourth we show as a special case that T_1 is of weak-type $(1, 1)$. Finally we tend to the remaining details of the proof.

Lemma 3.27. There is a constant C such that for all $R \geq 1$, all ε with $0 < \varepsilon \leq 1$, and all nonzero real a and b ,

$$(a) \quad \left| \int_{\varepsilon}^R \frac{\sin ar \, dr}{r} \right| \leq C,$$

$$(b) \quad \left| \int_{\varepsilon}^R \frac{(\cos ar - \cos br) \, dr}{r} \right| \leq C(1 + |\log(|a/b|)|).$$

PROOF. In (a) and (b), the signs of a and b make no difference, and we may therefore assume that $a > 0$ and $b > 0$.

In (a), the change of variables $s = ar$ converts the integral into $\int_{a\varepsilon}^{aR} \frac{\sin s \, ds}{s}$. Since $s^{-1} \sin s$ is integrable near 0, it is enough to consider $\int_0^S \frac{\sin s \, ds}{s}$. Integration by parts shows that this integral equals $\left[\frac{1 - \cos s}{s} \right]_0^S - \int_0^S \frac{(\cos s - 1) \, ds}{s^2}$. The integrated term tends to a finite limit as S tends to infinity, and the integral is absolutely convergent. Hence (a) follows.

In (b), possibly by interchanging a and b , we may assume that $c = b/a$ is ≤ 1 . The change of variables $s = ar$ converts the integral into $\int_{a\varepsilon}^{aR} \frac{(\cos s - \cos cs) \, ds}{s}$. Since $|1 - \cos s| \leq \frac{1}{2}s^2$ for all s , we have $|1 - \cos cs| \leq \frac{1}{2}c^2 s^2 \leq \frac{1}{2}s^2$. So the integrand is $\leq s$ in absolute value everywhere and in particular is integrable for s near 0. It is therefore enough to show that $\left| \int_1^S \frac{(\cos s - \cos cs) \, ds}{s} \right| \leq C(1 + \log(c^{-1}))$. Integration by parts gives $\int_1^S \frac{\cos s \, ds}{s} = \left[\frac{\sin s}{s} \right]_1^S + \int_1^S \frac{\sin s \, ds}{s^2}$. The integrated term tends to a finite limit, and the integral is absolutely convergent. Hence the term $\int_1^S \frac{\cos s \, ds}{s}$ is bounded, and it is enough to handle $\int_1^S \frac{\cos cs \, ds}{s}$. Putting $t = cs$ changes this integral to $\int_c^{cS} \frac{\cos t \, dt}{t}$. If $cS \geq 1$, the integral from 1 to cS contributes a bounded amount, as is seen by integrating by parts, and the integral from c to 1 contributes in absolute value at most $\int_c^1 \frac{dt}{t} = \log c^{-1}$. If $cS \leq 1$, the integral from c to cS contributes in absolute value at most $\int_c^1 \frac{dt}{t} + \int_{cS}^1 \frac{dt}{t} = \log c^{-1} + \log(cS)^{-1} \leq 2 \log c^{-1}$. \square

PROOF FOR THEOREM 3.26 THAT T_1 IS BOUNDED ON L^2 . Define $k(x)$ to be

$K(x)/|x|^N$ for $|x| \geq 1$ and to be 0 for $|x| < 1$. Then k is an L^2 function, and $T_1 f = k * f$. We show that T_1 is bounded on L^2 by showing that the Fourier transform $\mathcal{F}k$ of k is an L^∞ function.

If I_n denotes the indicator function of $\{|x| \leq n\}$, then the sequence $\{kI_n\}$ converges to k in L^2 . By the Plancherel formula, $\{\mathcal{F}(kI_n)\}$ converges to $\mathcal{F}k$ in L^2 . Thus a subsequence converges almost everywhere. To simplify the notation, let n run through the indices of the subsequence. We have just shown that

$$(\mathcal{F}k)(x) = \lim_n \int_{|x| \leq n} k(x) e^{-2\pi i x \cdot y} dx,$$

the limit existing almost everywhere. Write $x = r\omega$ and $y = r'\omega'$, where $r = |x|$ and $r' = |y|$. Then $x \cdot y = rr' \cos \gamma$, where $\gamma = \omega \cdot \omega'$, and $(\mathcal{F}k)(x)$ is the limit on n of

$$\begin{aligned} & \int_{S^{N-1}} \int_1^n \frac{K(\omega)}{r^N} e^{-2\pi i r r' \cos \gamma} r^{N-1} dr d\omega \\ &= \int_{S^{N-1}} \left[\int_1^n \frac{e^{-2\pi i r r' \cos \gamma}}{r} dr \right] K(\omega) d\omega \\ &= \int_{S^{N-1}} \left[\int_1^n \frac{(e^{-2\pi i r r' \cos \gamma} - \cos 2\pi r r')}{r} dr \right] K(\omega) d\omega \quad \text{since } K \text{ has} \\ & \hspace{15em} \text{mean value 0} \\ &= \int_{S^{N-1}} \left[\int_1^n \frac{(\cos(2\pi r r' \cos \gamma) - \cos 2\pi r r')}{r} dr \right] K(\omega) d\omega \\ & \quad - i \int_{S^{N-1}} \left[\int_1^n \frac{\sin(2\pi r r' \cos \gamma)}{r} dr \right] K(\omega) d\omega. \end{aligned}$$

Let us call the terms on the right side Term I and $-i$ Term II. The inner integral for Term II is bounded independently of r, r', γ, n by Lemma 3.27a. Since K is bounded, Term II is bounded.

The inner integral for Term I is bounded by $C(1 + \log(|\cos \gamma|^{-1}))$, according to Lemma 3.27b. Since K is bounded, the contribution from C by itself yields a bounded contribution to Term I and is harmless. We are left with a term that in absolute value is

$$\leq C \int_{S^{N-1}} \log(|\cos \gamma|^{-1}) |K(\omega)| d\omega = C \int_{S^{N-1}} \log(|\cos(\omega \cdot \omega')|^{-1}) |K(\omega)| d\omega.$$

Since K is bounded, it is enough to estimate $\int_{S^{N-1}} \log(|\cos(\omega \cdot \omega')|^{-1}) d\omega$. This integral is independent of ω' . We introduce spherical coordinates

$$\begin{aligned} \omega_1 &= \cos \theta_1, \\ \omega_2 &= \sin \theta_1 \cos \theta_2, \\ &\vdots \end{aligned}$$

and take $\omega' = (1, 0, \dots, 0)$. The integral becomes

$$\int_{\substack{0 \leq \theta_j \leq \pi \text{ for } j < N-1, \\ 0 \leq \theta_{N-1} \leq 2\pi}} \log(|\cos \theta_1|^{-1}) \sin^{N-2} \theta_1 \cdots \sin \theta_{N-2} d\theta_{N-1} \cdots d\theta_1,$$

which is a constant times $\int_0^\pi \log(|\cos \theta|^{-1}) \sin^{N-2} \theta d\theta$. This integral in turn is $\leq \int_0^\pi \log(|\cos \theta|^{-1}) d\theta$, whose finiteness reduces to the local integrability of $\log(|x|^{-1})$ on the line. Thus Term I is bounded, and the boundedness of $\mathcal{F}k$ follows. \square

Lemma 3.28 (Calderón–Zygmund decomposition). Let f be in $L^1(\mathbb{R}^N)$, and let ξ be a positive real number. Then there exists a finite or infinite disjoint sequence $\{E_n\}_{n \geq 1}$ of Borel subsets of \mathbb{R}^N such that

- (a) for each E_n , there exists a ball $B_n = B(r_n; x_n)$ such that the balls B_n and $B_n^* = B(5r_n; x_n)$ have $B_n \subseteq E_n \subseteq B_n^*$,
- (b) $\sum_n |E_n| \leq 5^N \|f\|_1 / \xi$,
- (c) $|f(x)| \leq \xi$ almost everywhere off $\bigcup_n E_n$,
- (d) $\frac{1}{|E_n|} \int_{E_n} |f(y)| dy \leq 5^N \xi$ for each n .

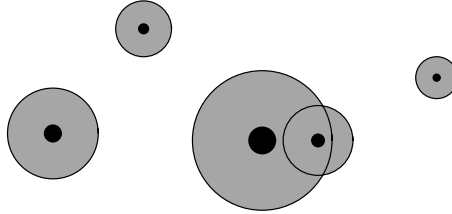

FIGURE 3.2. Calderón–Zygmund decomposition of \mathbb{R}^N relative to a function at a certain height. The set where the maximal function of f exceeds ξ lies in the union of the gray balls. The gray balls have radii 5 times those of the black balls, and the black balls are disjoint. The function $|f|$ is $\leq \xi$ almost everywhere off the union of the gray balls, and the sum of the volumes of the gray balls is controlled.

REMARKS. In the 1-dimensional case, this result was embedded in the proof of Theorem 8.25 of *Basic*. The sets E_n were open intervals. Extending that argument too literally to the N -dimensional case is unnecessarily complicated for current purposes. Instead, we settle for an n^{th} set that contains a ball of some radius about a point and is contained in a ball of 5 times that radius. Thus the n^{th}

set E_n consists of a black ball and part of the corresponding gray ball in Figure 3.2. The fact that E_n has not been precisely located makes the proof of weak-type (1, 1) in the present section more difficult than the proof of Theorem 8.25 of *Basic*.

PROOF. Let f^* be the Hardy–Littlewood maximal function

$$f^*(x) = \sup_{0 < r < \infty} |B(r; x)|^{-1} \int_{B(r; x)} |f(y)| dy,$$

and let $E = \{x \mid f^*(x) > \xi\}$. If x is in E , then $|B(r; x)|^{-1} \int_{B(r; x)} |f(y)| dy > \xi$ for some $r > 0$. On the other hand, $\lim_{r \rightarrow \infty} |B(r; x)|^{-1} \int_{B(r; x)} |f(y)| dy = 0$ since f is integrable. Thus, for each x in E , there exists an $r = r_x$ depending on x such that

$$|B(r_x; x)|^{-1} \int_{B(r_x; x)} |f(y)| dy > \xi$$

and

$$|B(5r_x; x)|^{-1} \int_{B(5r_x; x)} |f(y)| dy \leq \xi.$$

Since $\|f\|_1 \geq \int_{B(r_x; x)} |f(y)| dy > \xi |B(r_x; x)| = r_x^N \xi |B(1; 0)|$, the radii r_x are bounded. Applying the Wiener Covering Lemma¹² to the cover $\{B(r_x; x) \mid x \in E\}$ of E , we obtain a finite or infinite sequence of points x_1, x_2, \dots such that the balls $B(r_{x_n}; x_n)$ are disjoint and

$$E \subseteq \bigcup_n B(5r_{x_n}; x_n). \quad (*)$$

Write r_n for r_{x_n} . Put $E_1 = B(5r_1; x_1) - \bigcup_{j \neq 1} B(r_j; x_j)$, and define inductively

$$E_n = B(5r_n; x_n) - \bigcup_{j=1}^{n-1} E_j - \bigcup_{j \neq n} B(r_j; x_j).$$

By inspection

- (i) the sets E_n are disjoint,
- (ii) $B(r_n; x_n) \subseteq E_n \subseteq B(5r_n; x_n)$ for each n ,
- (iii) $\bigcup_n E_n = \bigcup_n B(5r_n; x_n)$.

Property (ii) immediately yields (a). The second inclusion of (ii) gives $\xi |E_n| \leq \xi |B(5r_n; x_n)| = 5^N \xi |B(r_n; x_n)| \leq 5^N \int_{B(r_n; x_n)} |f(y)| dy$. Summing on n and taking into account the disjointness of the sets $B(r_n; x_n)$, we obtain $\xi \sum_n |E_n| \leq 5^N \int_{\bigcup_n B(r_n; x_n)} |f(y)| dy \leq 5^N \|f\|_1$. This proves (b). The two inclusions of (ii) together yield $\int_{E_n} |f(y)| dy \leq \int_{B(5r_n; x_n)} |f(y)| dy \leq \xi |B(5r_n; x_n)| = 5^N \xi |B(r_n; x_n)| \leq 5^N \xi |E_n|$, and this proves (d). Finally (*) and (iii) together show that $E \subseteq \bigcup_n E_n$. Therefore $f^*(x) \leq \xi$ everywhere off $\bigcup_n E_n$. Since

$$\lim_{r \downarrow 0} |B(r; x)|^{-1} \int_{B(r; x)} |f(y)| dy = f(x)$$

almost everywhere on \mathbb{R}^N , we see that $|f(x)| \leq \xi$ almost everywhere off $\bigcup_n E_n$. This proves (c). \square

¹²Lemma 6.41 of *Basic*.

Lemma 3.29. Let k be in $L^2(\mathbb{R}^N)$, and define $Tf = k * f$ for f in $L^1 + L^2$. If

- (a) $\|Tf\|_2 \leq A\|f\|_2$ and
- (b) there exist constants B and $\alpha > 0$ such that

$$\int_{|x| \geq \alpha|y|} |k(x-y) - k(x)| dx \leq B$$

independently of y ,

then the operator T is of weak-type $(1, 1)$ with a constant depending only on A , B , α , and N .

PROOF. We are to estimate the measure of the set of x where $|(Tf)(x)| > \xi$. Fix f and ξ , and apply Lemma 3.28 to obtain disjoint Borel sets E_n and balls $B_n = B(r_n; x_n)$ and $B_n^* = B(5r_n; x_n)$ with $B_n \subseteq E_n \subseteq B_n^*$ and with the other properties listed in the lemma. Now that the sets E_n have been determined, we decompose f into the sum $f = g + b$ of a “good” function and a “bad” function by

$$g(x) = \begin{cases} \frac{1}{|E_n|} \int_{E_n} f(y) dy & \text{for } x \in E_n, \\ f(x) & \text{for } x \notin \bigcup_n E_n, \end{cases}$$

$$b(x) = \begin{cases} f(x) - \frac{1}{|E_n|} \int_{E_n} f(y) dy & \text{for } x \in E_n, \\ 0 & \text{for } x \notin \bigcup_n E_n. \end{cases}$$

Since $\{x \mid |Tf(x)| > \xi\} \subseteq \{x \mid |Tg(x)| > \xi/2\} \cup \{x \mid |Tb(x)| > \xi/2\}$, it is enough to prove

- (i) $|\{x \mid |Tg(x)| > \xi/2\}| \leq C\|f\|_1/\xi$ and
- (ii) $|\{x \mid |Tb(x)| > \xi/2\}| \leq C\|f\|_1/\xi$

for some constant C independent of ξ and f .

The definition of g shows that $\int_{E_n} |g(x)| dx \leq \int_{E_n} |f(x)| dx$ for all n and that $|g(x)| = |f(x)|$ for $x \notin \bigcup_n E_n$; therefore $\int_{\mathbb{R}^N} |g(x)| dx \leq \int_{\mathbb{R}^N} |f(x)| dx$. Also, properties (b) and (c) of the E_n 's show that $|g(x)| \leq 5^N \xi$ a.e. These two inequalities, together with the bound $\|Tg\|_2 \leq A\|g\|_2$, give

$$\begin{aligned} \int_{\mathbb{R}^N} |Tg(x)|^2 dx &\leq A^2 \int_{\mathbb{R}^N} |g(x)|^2 dx \\ &\leq 5^N \xi A^2 \int_{\mathbb{R}^N} |g(x)| dx \leq 5^N \xi A^2 \int_{\mathbb{R}^N} |f(x)| dx. \end{aligned}$$

Combining this result with Chebyshev's inequality

$$|\{x \mid |F(x)| > \beta\}| \leq \beta^{-2} \int_{\mathbb{R}^N} |F(x)|^2 dx$$

for the function $F = Tg$ and the number $\beta = \xi/2$, we obtain

$$|\{x \mid |Tg(x)| > \xi/2\}| \leq \frac{4}{\xi^2} 5^N \xi A^2 \int_{\mathbb{R}^N} |f(x)| dx = \frac{4 \cdot 5^N A^2 \|f\|_1}{\xi}.$$

This proves (i).

For the function b , let b_n be the product of b with the indicator function of E_n . Then we have $b = \sum_n b_n$ with the sum convergent in L^1 . Inspection of the definition shows that $\|b_n\|_1 \leq 2 \int_{E_n} |f(y)| dy$, and therefore $\|b\|_1 \leq 2\|f\|_1$. Since T is convolution by the L^2 function k and since $b = \sum_n b_n$ in L^1 , $Tb = \sum_n Tb_n$ with the sum convergent in L^2 . A subsequence of partial sums therefore converges almost everywhere. Inserting absolute values consistently with the subsequence and then inserting absolute values around each term, we see that

$$|Tb(x)| \leq \sum_n |Tb_n(x)| \quad \text{a.e.}$$

Let α be the constant in hypothesis (b). The measure of $\bigcup_n B(5\alpha r_n; x_n)$ is

$$\begin{aligned} |\bigcup_n B(5\alpha r_n; x_n)| &\leq \sum_n |B(5\alpha r_n; x_n)| = \sum_n 5^N \alpha^N |B(r_n; x_n)| \\ &\leq 5^N \alpha^N \sum_n |E_n| \leq 5^{2N} \alpha^N \|f\|_1 / \xi. \end{aligned}$$

Let $X = \mathbb{R}^N - \bigcup_n B(5\alpha r_n; x_n)$. If we show that $\int_X |Tb(x)| dx \leq C' \|f\|_1$, then we will have

$$|\{x \mid |Tb(x)| > \xi/2\}| \leq (5^{2N} \alpha^N + 2C') \|f\|_1 / \xi, \quad (*)$$

and (ii) will be proved. Put $\tau_n(X) = \{x - x_n \mid x \in X\}$. Since $\int_{E_n} b(y) dy = 0$ for each n ,

$$\begin{aligned} \int_X |Tb(x)| dx &\leq \sum_n \int_X |Tb_n(x)| dx \\ &= \sum_n \int_X \left| \int_{E_n} k(x-y)b(y) dy \right| dx \\ &= \sum_n \int_X \left| \int_{E_n} [k(x-y) - k(x-x_n)]b(y) dy \right| dx \\ &\leq \sum_n \int_X \int_{E_n} |k(x-y) - k(x-x_n)| |b(y)| dy dx \\ &\stackrel{x-x_n \rightarrow x}{=} \sum_n \int_{E_n} \left[\int_{\tau_n(X)} |k(x+x_n-y) - k(x)| dx \right] |b(y)| dy \\ &\leq \sum_n \int_{E_n} \left[\int_{B(5\alpha r_n; 0)^c} |k(x+x_n-y) - k(x)| dx \right] |b(y)| dy. \end{aligned}$$

In the n^{th} term on the right side, y is in $E_n \subseteq B_n^*$, and hence $|x_n - y| \leq 5r_n$; meanwhile, $|x| \geq 5\alpha r_n$. Therefore $|x| \geq 5\alpha r_n \geq \alpha|x_n - y|$. The right side in the display is not decreased by increasing the region of integration in the x variable, and hence the right side is

$$\begin{aligned} &\leq \sum_n \int_{E_n} \left[\int_{|x| \geq \alpha|x_n - y|} |k(x+x_n-y) - k(x)| dx \right] |b(y)| dy \\ &\leq \sum_n \int_{E_n} B |b(y)| dy = B \|b\|_1 \leq 2B \|f\|_1. \end{aligned}$$

Therefore (*) is proved with $C' = 2B$, and the proof of (ii) is complete. \square

PROOF FOR THEOREM 3.26 THAT T_1 IS OF WEAK-TYPE $(1, 1)$. With $k(x)$ taken to be $K(x)/|x|^N$ for $|x| \geq 1$ and to be 0 for $|x| < 1$, Lemma 3.29 shows that it is enough to prove that

$$\int_{|x| \geq 2|y|} |k(x-y) - k(x)| dx \leq B \quad (*)$$

with B independent of y . The function k is bounded, and thus the contribution to the integral in $(*)$ from the bounded set of x 's where $|x| < 1$ is bounded independently of y . The set of x 's where $|x-y| < 1$ is a ball whose measure is bounded as a function of y , and thus this set too contributes a bounded term to the integral in $(*)$. It is therefore enough to prove that

$$\int_{\substack{|x| \geq 2|y|, \\ |x-y| \geq 1, |x| \geq 1}} \left| \frac{K(x-y)}{|x-y|^N} - \frac{K(x)}{|x|^N} \right| dx$$

is bounded as a function of y . If M is an upper bound for $|K|$, then this expression is

$$\begin{aligned} &\leq \int |K(x-y)| \left| \frac{1}{|x-y|^N} - \frac{1}{|x|^N} \right| dx + \int \frac{|K(x-y) - K(x)|}{|x|^N} dx \\ &\leq M \int_{\substack{|x| \geq 2|y|, \\ |x| \geq 1}} \left| \frac{1}{|x-y|^N} - \frac{1}{|x|^N} \right| dx + \int_{\substack{|x| \geq 2|y|, \\ |x| \geq 1}} \frac{|K(x-y) - K(x)|}{|x|^N} dx. \quad (**) \end{aligned}$$

We use the two estimates

$$|x-y| \leq |x| + |y| \leq |x| + \frac{1}{2}|x| = \frac{3}{2}|x|$$

and $|x-y| \geq |x| - |y| = (\frac{1}{2}|x| - |y|) + \frac{1}{2}|x| \geq \frac{1}{2}|x|$.

The integrand in the first term of $(**)$ is equal to

$$\begin{aligned} &\left| \frac{1}{|x-y|^N} - \frac{1}{|x|^N} \right| = \left| \frac{|x|^N - |x-y|^N}{|x|^N |x-y|^N} \right| \leq 2^N \left| \frac{|x|^N - |x-y|^N}{|x|^{2N}} \right| \\ &\leq 2^N \frac{||x| - |x-y|| (|x|^{N-1} + |x|^{N-2}|x-y| + \dots + |x-y|^{N-1})}{|x|^{2N}} \\ &\leq 2^N \frac{|y| (|x|^{N-1} + |x|^{N-2}|x-y| + \dots + |x-y|^{N-1})}{|x|^{2N}} \leq 2^N \left(\frac{3}{2}\right)^N \frac{|y| (|x|^{N-1} + |x|^{N-1} + \dots + |x|^{N-1})}{|x|^{2N}} \\ &= N3^N \frac{|y|}{|x|^{N+1}}. \end{aligned}$$

Thus the integral in the first term of $(**)$ is

$$\begin{aligned} &\leq N3^N \int_{|x| \geq \max\{1, 2|y|\}} \frac{|y|}{|x|^{N+1}} dx = N3^N \Omega_{N-1} \int_{\max\{1, 2|y|\}}^{\infty} \frac{|y|}{r^{N+1}} r^{N-1} dr \\ &= N3^N \Omega_{N-1} \frac{|y|}{\max\{1, 2|y|\}} \leq \frac{1}{2} N3^N \Omega_{N-1}, \end{aligned}$$

and this is bounded independently of y .

For the second term of (**), we start from the estimate

$$\left| \frac{z}{|z|} - \frac{w}{|w|} \right| \leq \frac{|z-w|}{\min\{|z|, |w|\}}. \quad (\dagger)$$

To verify (\dagger) , we may assume that $|z| \geq |w|$. Then $\frac{|z|}{|w|} + 1 \geq \frac{2z \cdot w}{|z||w|}$ because the left side is ≥ 2 and the right side is ≤ 2 . Multiplying by $\frac{|z|}{|w|} - 1$, we obtain $\frac{|z|^2}{|w|^2} - 1 \geq \frac{2z \cdot w}{|w|^2} - \frac{2z \cdot w}{|z||w|}$. Hence $1 - \frac{2z \cdot w}{|z||w|} + 1 \leq \frac{|z|^2}{|w|^2} - \frac{2z \cdot w}{|w|^2} + 1$, which is the square of (\dagger) .

Using (\dagger) and the definition and monotonicity of the function ψ that is defined in the remarks with the theorem and that captures the smoothness of K , we have

$$|K(x-y) - K(x)| = \left| K\left(\frac{x-y}{|x-y|}\right) - K\left(\frac{x}{|x|}\right) \right| \leq \psi\left(\left|\frac{x-y}{|x-y|} - \frac{x}{|x|}\right|\right) \leq \psi\left(\frac{|y|}{\min\{|x-y|, |x|\}}\right).$$

Since $|x-y| \geq \frac{1}{2}|x|$, $\min\{|x-y|, |x|\} \geq \frac{1}{2}|x|$. Thus $\psi\left(\frac{|y|}{\min\{|x-y|, |x|\}}\right) \leq \psi\left(\frac{2|y|}{|x|}\right)$, and the computation

$$\begin{aligned} \int_{\substack{|x| \geq 2|y|, \\ |x| \geq 1}} \frac{|K(x-y) - K(x)|}{|x|^N} dx &\leq \int_{\substack{|x| \geq 2|y|, \\ |x| \geq 1}} \frac{\psi(2|y|/|x|)}{|x|^N} dx = \int_{\substack{|z| \geq 1, \\ |z| \geq 1/2|y|}} \frac{\psi(1/|z|)}{|z|^N} dz \\ &= \Omega_{N-1} \int_{\max\{1, 1/2|y|\}}^{\infty} \psi(1/r) r^{-1} dr \\ &= \Omega_{N-1} \int_0^{\min\{1, 2|y|\}} \psi(\delta) \delta^{-1} d\delta \\ &\leq \Omega_{N-1} \int_0^1 \psi(\delta) \delta^{-1} d\delta \end{aligned}$$

shows that the second term of (**) is bounded independently of y . \square

PROOF OF REMAINDER OF THEOREM 3.26. We can now argue in the same way that the Hilbert transform was handled in Chapter IX of *Basic*. Since T_1 has been shown to be bounded on L^2 and to be of weak-type $(1, 1)$, the Marcinkiewicz Interpolation Theorem given in Theorem 9.20 of *Basic* shows that $\|T_1 f\|_p \leq A_p \|f\|_p$ for $1 < p \leq 2$ with A_p independent of f . Lemma 9.22 of *Basic* extends this conclusion to $1 < p < \infty$. The argument that proves Theorem 9.23a in *Basic* applies here and shows that $\|T_\varepsilon f\|_p \leq A_p \|f\|_p$ for $1 < p < \infty$ with A_p independent of f and ε . This proves Theorem 3.26a.

The same argument as in Lemma 9.24 of *Basic* shows that if f is a C^1 function of compact support on \mathbb{R}^N , then

$$\lim_{\varepsilon \downarrow 0} \int_{|y| \geq \varepsilon} \frac{K(y) f(x-y) dy}{|y|^N}$$

exists uniformly and in L^p for every $p > 1$. This proves (b) of Theorem 3.26 for the dense set of C^1 functions f of compact support.

To prove the norm convergence when we are given a general f in L^p with $1 < p < \infty$, we choose a sequence f_n in the dense set with $f_n \rightarrow f$ in L^p . Then

$$\begin{aligned} \|T_\varepsilon f - T_{\varepsilon'} f\|_p &\leq \|T_\varepsilon(f - f_n)\|_p + \|T_\varepsilon f_n - T_{\varepsilon'} f_n\|_p + \|T_{\varepsilon'}(f_n - f)\|_p \\ &\leq A_p \|f_n - f\|_p + \|T_\varepsilon f_n - T_{\varepsilon'} f_n\|_p + A_p \|f_n - f\|_p. \end{aligned}$$

Choose n to make the first and third terms small on the right, and then choose ε and ε' sufficiently close to 0 so that the second term on the right is small. The result is that $T_{\varepsilon_n} f$ is Cauchy in L^p along any sequence $\{\varepsilon_n\}$ tending to 0. This proves Theorem 3.26b.

For any f in L^p with $1 < p < \infty$, we have just seen that $T_\varepsilon f \rightarrow Tf$ in L^p . Then (a) gives $\|Tf\|_p = \lim_{\varepsilon \downarrow 0} \|T_\varepsilon f\|_p \leq \limsup_{\varepsilon \downarrow 0} A_p \|f\|_p = A_p \|f\|_p$. This proves Theorem 3.26c. \square

6. Applications of the Calderón–Zygmund Theorem

EXAMPLE 1. Riesz transforms. These are a more immediate N -dimensional analog of the Hilbert transform than is the operator in the Calderón–Zygmund Theorem. In \mathbb{R}^1 , the Poisson kernel and conjugate Poisson kernel are given by

$$P(x, y) = P_y(x) = \frac{1}{\pi} \frac{y}{x^2 + y^2} \quad \text{and} \quad Q(x, y) = Q_y(x) = \frac{1}{\pi} \frac{x}{x^2 + y^2}.$$

The conjugate Poisson kernel Q may be obtained starting from the Poisson kernel P by applying the Cauchy–Riemann equations in the form

$$\frac{\partial P}{\partial x} = \frac{\partial Q}{\partial y} \quad \text{and} \quad \frac{\partial Q}{\partial x} = -\frac{\partial P}{\partial y}$$

and by requiring that Q vanish at infinity. The differential equations lead to the solution

$$Q(x, y) = \int_{-\infty}^{(x,y)} \frac{\partial P}{\partial x} dy.$$

The Hilbert transform kernel may be obtained by letting y decrease to 0 in $Q(x, y)$. The resulting formal convolution formula

$$Hf(x) = \frac{1}{\pi} \int_{-\infty}^{\infty} \frac{f(x-t)}{t} dt$$

is to be interpreted in such a way as to represent passage from the boundary values of $P_y * f$ to the boundary values of $Q_y * f$. We know that a valid way of arriving at this interpretation is to take the integral for $|t| \geq \varepsilon$ and let ε decrease to 0.

In N dimensions the Poisson kernel for \mathbb{R}_+^{N+1} is

$$P(x, t) = P_t(x) = \frac{c_N t}{(|x|^2 + t^2)^{\frac{1}{2}(N+1)}}, \quad x \in \mathbb{R}^N, t > 0,$$

with $c_N = \pi^{-\frac{1}{2}(N+1)} \Gamma(\frac{N+1}{2})$. If we write x_{N+1} in place of t , the natural extension of the Cauchy–Riemann equations is the system for the $(N + 1)$ -component function $u = (u_1, \dots, u_{N+1})$ given by

$$\operatorname{div} u = 0 \quad \text{and} \quad \operatorname{curl} u = 0,$$

$$\text{i.e.,} \quad \sum_{i=1}^{N+1} \frac{\partial u_i}{\partial x_i} = 0 \quad \text{and} \quad \frac{\partial u_i}{\partial x_j} = \frac{\partial u_j}{\partial x_i} \quad \text{when } i \neq j.$$

A solution is (Q_1, \dots, Q_N, P) , where

$$Q_j(x, t) = \frac{c_N x_j}{(|x|^2 + t^2)^{\frac{1}{2}(N+1)}}, \quad x \in \mathbb{R}^N, t > 0.$$

Imitating the procedure summarized above for the Hilbert transform, we let t decrease to 0 here and arrive at the kernel

$$\frac{c_N x_j}{|x|^{N+1}}.$$

Accordingly, we define the j^{th} **Riesz transform** for $1 \leq j \leq N$ by

$$R_j f(x) = c_N \lim_{\varepsilon \downarrow 0} \int_{|y| \geq \varepsilon} \frac{y_j}{|y|^{N+1}} f(x - y) dy.$$

The Calderón–Zygmund Theorem (Theorem 3.26) shows that R_j is a bounded operator on $L^p(\mathbb{R}^N)$ for $1 < p < \infty$. The multiplier on the Fourier transform side can be obtained routinely from the formula for the Fourier transform of $P_t(x)$, namely $\widehat{P}_t(y) = e^{-2\pi t|y|}$, by using the differential equations and letting t decrease to 0. The result is

$$\widehat{R_j f}(y) = -\frac{iy_j}{|y|} \widehat{f}(y).$$

A sample application of the Riesz transforms is to an inequality asserting that the Laplacian controls all mixed second derivatives for smooth functions of compact support:

$$\left\| \frac{\partial}{\partial x_j} \frac{\partial}{\partial x_k} \varphi \right\|_p \leq A_p \|\Delta \varphi\|_p \quad \text{for } 1 < p < \infty \text{ and } \varphi \in C_{\text{com}}^\infty(\mathbb{R}^N).$$

The argument works as well for all Schwartz functions φ : the partial derivatives satisfy the identity $\frac{\partial}{\partial x_j} \frac{\partial}{\partial x_k} \varphi = -R_j R_k \Delta \varphi$ because the equality

$$-4\pi^2 y_j y_k \widehat{\varphi}(y) = -\left(-\frac{iy_j}{|y|}\right) \left(-\frac{iy_k}{|y|}\right) (-4\pi^2 |y|^2) \widehat{\varphi}(y)$$

shows that the Fourier transforms are equal.

EXAMPLE 2. Beltrami equation. This will be an application in which the L^p theory of the Calderón–Zygmund Theorem is essential for some $p \neq 2$. We deal with functions on \mathbb{R}^2 . Define

$$\frac{\partial}{\partial z} = \frac{1}{2} \left(\frac{\partial}{\partial x} - i \frac{\partial}{\partial y} \right) \quad \text{and} \quad \frac{\partial}{\partial \bar{z}} = \frac{1}{2} \left(\frac{\partial}{\partial x} + i \frac{\partial}{\partial y} \right).$$

We shall use the abbreviations $f_z = \frac{\partial f}{\partial z}$ and $f_{\bar{z}} = \frac{\partial f}{\partial \bar{z}}$. The Cauchy–Riemann equations, testing whether a complex-valued function on \mathbb{R}^2 is analytic, become the single equation $f_{\bar{z}} = 0$.

We shall use weak derivatives on \mathbb{R}^2 in the sense of Section 2. Let μ be in $L^\infty(\mathbb{R}^2)$ with $\|\mu\|_\infty = k < 1$. In the sense of weak derivatives, the **Beltrami equation** is

$$f_{\bar{z}} = \mu f_z.$$

This equation is fundamental in dealing with Riemann surfaces, since solutions to it provide “quasiconformal mappings” with certain properties. For simplicity we assume that μ has compact support. We seek a solution f such that $f(0) = 0$ and $f_z - 1$ is in some L^p class.

The equation is solved by first putting it in another form. Let

$$Ph(\zeta) = -\frac{1}{\pi} \int_{\mathbb{R}^2} \left(\frac{1}{z - \zeta} - \frac{1}{z} \right) h(z) dx dy.$$

The factor in parentheses is in $L^q(\mathbb{R}^2)$ for $1 \leq q < 2$, and Hölder’s inequality shows that Ph is therefore well defined for h in $L^p(\mathbb{R}^2)$ if $p > 2$. In fact, one can show that $|Ph(\zeta_1) - Ph(\zeta_2)| \leq C \|h\|_p |\zeta_1 - \zeta_2|^{1 - \frac{2}{p}}$, and therefore Ph is continuous for such h . Observe that $Ph(0) = 0$ for all h . Also, one can show that

$$(Ph)_{\bar{z}} = h \quad \text{in the sense of weak derivatives.} \quad (*)$$

However, the definition of P falls apart for $p = 2$. Now define

$$Th(\zeta) = \lim_{\varepsilon \downarrow 0} -\frac{1}{\pi} \int_{|z - \zeta| \geq \varepsilon} \frac{h(z)}{(z - \zeta)^2} dx dy.$$

The operator T is bounded on $L^p(\mathbb{R}^2)$ for $1 < p < \infty$ by the Calderón–Zygmund Theorem, and we shall be interested in h as above, thus interested in $p > 2$. One can show that

$$(Ph)_z = Th \quad \text{in the sense of weak derivatives if } h \in L^p \text{ with } p > 2. \quad (**)$$

Now we can transform the Beltrami equation. Suppose that f is a weak solution of the Beltrami equation with $f(0) = 0$ and $f_z - 1$ in L^p for some p with $p > 2$.

Since μ is in L^∞ , $\mu f_z - \mu$ is in L^p , and since μ has compact support, μf_z is in L^p . Then $f_{\bar{z}} = \mu f_z$ is in L^p , and $P(f_{\bar{z}})$ is defined. The function $f - P(f_{\bar{z}})$ is analytic because (*) shows that $\frac{\partial}{\partial \bar{z}}(f - P(f_{\bar{z}})) = f_{\bar{z}} - f_{\bar{z}} = 0$. One can easily show that this analytic function has to be z , i.e., that

$$f = P(f_{\bar{z}}) + z.$$

Differentiating with respect to z and using (**), we obtain $f_z = T(f_{\bar{z}}) + 1 = T(\mu f_z) + 1$. The equation

$$f_z = T(\mu f_z) + 1 \quad (\dagger)$$

is the transformed equation.

Assuming that f is a solution of the Beltrami equation and therefore of (\dagger), we shall manipulate (\dagger) a little and arrive at a formula for f . Multiply (\dagger) by μ and apply T to get $T(\mu f_z) = T\mu T\mu f_z + T\mu$. Adding 1 and substituting from (\dagger) gives

$$f_z = T\mu T\mu f_z + T\mu + 1.$$

Iteration of this procedure yields

$$f_z = (T\mu)^n f_z + [1 + T\mu + \cdots + (T\mu)^{n-1}].$$

We want to arrange that the first term on the right side tends to 0 in the limit on n . The operations of P and T have together made sense only on L^p for $p > 2$. The linear operator $g \mapsto \mu g$ on L^p has norm $\|\mu\|_\infty = k < 1$, and T has norm A_p , say. It can be shown that T is unitary on L^2 , so that $A_2 = 1$. The Marcinkiewicz Interpolation Theorem does not reveal good limiting behavior for the bounds of operators at the endpoints of an interval of p 's where it is applied, but the Riesz Convexity Theorem¹³ does. Consequently we can conclude that $\limsup_{p \downarrow 2} A_p = 1$. Therefore the operator $g \mapsto T\mu g$, with norm $\leq kA_p$ on L^p for $p > 2$, has norm < 1 if p is sufficiently close to 2 (but is greater than 2). Fix such a p . Then we have

$$\|(T\mu)^n f_z\|_p \leq \|T\mu\|^{n-1} \|T\mu f_z\|_p \longrightarrow 0,$$

and

$$f_z = \lim_n [1 + T\mu + \cdots + (T\mu)^{n-1}].$$

The function $f_z - 1 = \lim_n [T\mu + \cdots + (T\mu)^{n-1}]$ is certainly in L^p . As a solution of the Beltrami equation, f has $f_{\bar{z}} = \mu f_z = \mu + \mu \lim_n [T\mu + \cdots + (T\mu)^{n-1}]$.

¹³The Riesz Convexity Theorem uses complex analysis. It was stated in Chapter IX of *Basic*, but the proof was omitted.

We saw above that any solution f of the Beltrami equation with $f(0)$ and with $f_z - 1$ in L^p has to satisfy $f = P(f_{\bar{z}}) + z$. Thus our formula for f is

$$f = P(\mu + \mu \lim_n [T\mu + \cdots + (T\mu)^{n-1}]) + z.$$

Finally we can turn things around and check that this process actually gives a solution. Define $g = \mu + \mu \lim_n [T\mu + \cdots + (T\mu)^{n-1}]$ in L^p , and put $f = Pg + z$. Application of (*) and (**) gives $f_{\bar{z}} = g$ and $f_z = Tg + 1$. Substitution of the formula for g into these yields

$$\begin{aligned} f_{\bar{z}} &= \mu + \mu \lim_n [T\mu + \cdots + (T\mu)^{n-1}] = \mu(1 + \lim_n [T\mu + \cdots + (T\mu)^{n-1}]) \\ &= \mu(1 + T(\lim_n \mu + \mu T\mu + \cdots + \mu(T\mu)^{n-2})) = \mu(1 + Tg) = \mu f_z, \end{aligned}$$

as required. The equality $f_z = Tg + 1$ shows that $f_z - 1$ is in L^p , and the fact that $Ph(0) = 0$ for all h shows that $f(0) = (Pg + z)(0) = 0$.

7. Multiple Fourier Series

Fourier series in several variables are a handy tool for local problems with linear differential equations. One isolates a problem in a bounded subset of \mathbb{R}^N and then reproduces it periodically in each variable, using a large period. Multiple Fourier series for potentially rough functions is a complicated subject, but we have no need for it. What is required is information about Fourier series of smooth functions. The relevant theory is presented in this section, using 2π for the period in each variable, and a relatively simple application is given in the next section. A more decisive application appears in Chapter VII, where we establish local solvability of linear partial differential equations with constant coefficients.

If f is a locally integrable function on \mathbb{R}^N that is periodic of period 2π in each variable, its **multiple Fourier series** is given by

$$f(x) \sim \sum_k c_k e^{ik \cdot x},$$

the sum being over all integer N -tuples and the coefficients c_k being given by

$$c_k = (2\pi)^{-N} \int_{-\pi}^{\pi} \cdots \int_{-\pi}^{\pi} f(x) e^{-ik \cdot x} dx.$$

Let us write \mathbb{Z}^N for the set of all integer N -tuples and $[-\pi, \pi]^N$ for the region of integration. Such series have the following properties.

Proposition 3.30. If f is a locally integrable function on \mathbb{R}^N that is periodic of period 2π in each variable, then

- (a) $|c_k| \leq \|f\|_1$ relative to $L^1([-\pi, \pi]^N, (2\pi)^{-N} dx)$,
- (b) $|c_k| \leq C_M |k|^{-M}$ for every positive integer M if f is smooth,
- (c) $\sum_{k \in \mathbb{Z}^N} c_k e^{ik \cdot x}$ is smooth and periodic if $|c_k| \leq C_M |k|^{-M}$ for every positive integer M ,
- (d) $\{e^{ik \cdot x}\}_{k \in \mathbb{Z}^N}$ is an orthonormal basis of $L^2([-\pi, \pi]^N, (2\pi)^{-N} dx)$,
- (e) $f(x) = \sum_{k \in \mathbb{Z}^N} c_k e^{ik \cdot x}$ if f is smooth.

PROOF. Conclusion (a) is evident by inspection of the definition. For (b), integration by parts shows that any C^1 periodic function f has the property that

$$(ik_j) \int_{[-\pi, \pi]^N} f(x) e^{-ik \cdot x} dx = \int_{[-\pi, \pi]^N} D_j f(x) e^{-ik \cdot x} dx.$$

Apart from the factor of $(2\pi)^{-N}$, the right side is a Fourier coefficient, and its size is controlled by (a). Iterating this formula, we see, in the case that f is smooth, that the Fourier coefficients c_k of f have the property that $\{P(k)c_k\}_{k \in \mathbb{Z}^N}$ is bounded for every polynomial P . Then (b) follows.

Conclusion (c) is immediate from the standard theorem about interchanging sums and derivatives. The result (d) is known in the 1-dimensional case, and the N -dimensional case then follows from Proposition 12.9 of *Basic*. In (e), the series converges to f in L^2 as a consequence of (d), and hence a subsequence converges almost everywhere to f . On the other hand, the series converges uniformly to something smooth by (c). The smooth limit must be almost everywhere equal to f , and it must equal f since f is smooth. \square

8. Application to Traces of Integral Operators

We return to the topic of traces of linear operators on Hilbert spaces, which was introduced in Section II.5. That section defined trace-class operators as a subset of the compact operators, and the trace of such an operator L is then given by $\sum_i (Lu_i, u_i)$, where $\{u_i\}$ is an orthonormal basis. The defining condition for trace class was hard to check, but Proposition 2.9 gave a sufficient condition: if $L : V \rightarrow V$ is bounded and if $\sum_{i,j} |(Lu_i, v_j)| < \infty$ for some orthonormal bases $\{u_i\}$ and $\{v_j\}$, then L is of trace class.

In this section we use multiple Fourier series to show how traces can be computed for simple integral operators in a Euclidean setting. The setting for realistic applications is to be a compact smooth manifold. Such manifolds are introduced in Chapter VIII, and the present result is to be regarded as the main step toward a theorem about traces of integral operators on smooth manifolds.¹⁴

¹⁴Traces of integral operators play a role in the representation theory of noncompact locally com-

Proposition 3.31. Let $K(\cdot, \cdot)$ be a complex-valued smooth function on $\mathbb{R}^N \times \mathbb{R}^N$ that is periodic of period 2π in each of the $2N$ variables, and suppose that the subset of $[-\pi, \pi]^N \times [-\pi, \pi]^N$ where K is nonzero is contained in $[-\frac{\pi}{8}, \frac{\pi}{8}]^N \times [-\frac{\pi}{8}, \frac{\pi}{8}]^N$. Define a bounded linear operator L on the Hilbert space $L^2([-\pi, \pi]^N, (2\pi)^{-N} dx)$ by

$$Lf(x) = \frac{1}{(2\pi)^N} \int_{[-\pi, \pi]^N} K(x, y) f(y) dy.$$

Then L is of trace class, and its trace is given by

$$\text{Tr } L = \frac{1}{(2\pi)^N} \int_{[-\pi, \pi]^N} K(x, x) dx.$$

PROOF. For each k in \mathbb{Z}^N , the effect of L on the function $x \mapsto e^{ik \cdot x}$ is

$$L(e^{ik \cdot (\cdot)})(x) = \frac{1}{(2\pi)^N} \int_{[-\pi, \pi]^N} K(x, y) e^{ik \cdot y} dy.$$

Taking the inner product in $L^2([-\pi, \pi]^N, (2\pi)^{-N} dx)$ with $x \mapsto e^{il \cdot x}$ gives

$$(L(e^{ik \cdot (\cdot)}), e^{il \cdot (\cdot)}) = \frac{1}{(2\pi)^{2N}} \iint_{[-\pi, \pi]^{2N}} K(x, y) e^{ik \cdot y} e^{-il \cdot x} dy dx. \quad (*)$$

The right side is a multiple-Fourier-series coefficient of the function K , and it is estimated by Proposition 3.30b. Proposition 3.30c shows that the corresponding trigonometric series converges absolutely. The functions $e^{ik \cdot x}$ are an orthonormal basis of $L^2([-\pi, \pi]^N, (2\pi)^{-N} dx)$ as a consequence of Proposition 3.30d, and therefore the sufficient condition of Proposition 2.9 is met for L to be of trace class.

To compute the trace, we start from (*) with $k = l$. We change variables, letting $u = y - x$ and $v = y + x$, and the right side of (*) becomes

$$\frac{1}{(2\pi)^{2N}} \iint_{[-\pi, \pi]^{2N}} 2^{-N} K\left(\frac{1}{2}(v - u), \frac{1}{2}(v + u)\right) e^{ik \cdot u} du dv$$

because of the small support of K . We sum on k in \mathbb{Z}^N , moving the sum under the integration with respect to v and recognizing the sum inside as the sum of the multiple-Fourier-series coefficients in the u variable, i.e., the sum

compact groups and in index theory. Both these topics are beyond the scope of this book. Consequently Chapter VIII does not carry out the easy argument to extend the Euclidean result to compact smooth manifolds.

of the series at the origin. Since the functions $e^{ik \cdot u}$ are an orthonormal basis of $L^2([- \pi, \pi]^N, (2\pi)^{-N} dx)$, the sum of the uniformly convergent multiple Fourier series has to be the function itself. Thus we find that

$$\text{Tr } L = \frac{1}{(4\pi)^N} \int_{[-\pi, \pi]^N} K\left(\frac{1}{2}v, \frac{1}{2}v\right) dv.$$

Replacing $\frac{1}{2}v$ by v and again taking into account the small support of K , we obtain the formula asserted. \square

9. Problems

1. Check that $(1 + 4\pi^2|y|^2)^{-1}g$ is in the Schwartz space \mathcal{S} if g is in \mathcal{S} , so that $(1 - \Delta)u = f$ is solvable in \mathcal{S} if f is in \mathcal{S} .
2. Show that the Schwartz space \mathcal{S} is closed under pointwise product and convolution, and show that these operations are continuous from $\mathcal{S} \times \mathcal{S}$ into \mathcal{S} .
3. If Ω is the open disk in \mathbb{R}^2 with $x^2 + y^2 < \frac{1}{2}$, prove the following:
 - (a) The function $(x, y) \mapsto \log((x^2 + y^2)^{-1})$ is in $L^p_1(\Omega)$ for $1 \leq p < 2$ but is not in $L^2_1(\Omega)$.
 - (b) The unbounded function $(x, y) \mapsto \log \log((x^2 + y^2)^{-1})$ is in $L^2_1(\Omega)$.
4. Let Ω be a nonempty bounded open set in \mathbb{R}^n , and suppose that there exists a real-valued C^1 function h on \mathbb{R}^n such that h is positive on Ω , h is negative on $(\Omega^c)^c$, and the first partial derivatives of h do not simultaneously vanish at any point of the boundary $\Omega^c - \Omega$. Prove that Ω satisfies the cone condition of Section 2.

Problems 5–7 compute explicitly the Fourier transforms of the members of a family of tempered distributions.

5. Show that the function $|x|^{-(N-\alpha)}$ on \mathbb{R}^N is a tempered distribution if $0 < \alpha < N$. For what values of α is it the sum of an L^1 function and an L^2 function?
6. Verify the identity $\int_0^\infty t^{\beta-1} e^{-\pi|x|^2 t} dt = \int_0^\infty t^{-\beta-1} e^{-\pi|x|^2/t} dt = \Gamma(\beta)(\pi|x|^2)^{-\beta}$.
7. Let φ be in $\mathcal{S}(\mathbb{R}^N)$. Taking the formula $\mathcal{F}(e^{-\pi t|x|^2}) = t^{-N/2} e^{-\pi|x|^2/t}$ as known and applying the multiplication formula, obtain the identity

$$\int_{\mathbb{R}^N} e^{-\pi t|x|^2} \widehat{\varphi}(x) dx = t^{-N/2} \int_{\mathbb{R}^N} e^{-\pi|x|^2/t} \varphi(x) dx.$$

Multiply both sides by $t^{\frac{1}{2}(N-\alpha)-1}$ and integrate in t . Dropping dx from the notation for tempered distributions that are given by functions, conclude from the resulting formula that

$$\mathcal{F}(|x|^{-\alpha}) = \frac{\pi^{-\frac{1}{2}N+\alpha} \Gamma(\frac{1}{2}(N-\alpha))}{\Gamma(\frac{1}{2}\alpha)} |x|^{-(N-\alpha)}$$

as tempered distributions if $0 < \alpha < N$.

Problems 8–12 introduce a family $H^s = H^s(\mathbb{R}^N)$ of Hilbert spaces for s real that are known as spaces of **Bessel potentials**. Because of Problem 8 below, these spaces are sometimes called “Sobolev spaces.” The space H^s consists of all tempered distributions $T \in \mathcal{S}'(\mathbb{R}^N)$ whose Fourier transforms $\mathcal{F}(T)$ are locally square integrable functions such that $\int_{\mathbb{R}^N} |\mathcal{F}(T)|^2 (1 + |\xi|^2)^s d\xi$ is finite, the norm $\|T\|_{H^s}$ being the square root of this expression. The spaces H^s get larger as s decreases.

8. Let $s \geq 0$ be an integer, and let T be a tempered distribution.
 - (a) Prove that if T is in H^s , then all distributions $D^\alpha T$ with $|\alpha| \leq s$ are L^2 functions. In this situation, if T is the L^2 function f , conclude that f is in $L^2_s(\mathbb{R}^N)$.
 - (b) Prove conversely that if $D^\alpha T$ is given by an L^2 function whenever $|\alpha| \leq s$, then T is in H^s .
 - (c) As a consequence of (a) and (b), H^s can be identified with $L^2_s(\mathbb{R}^N)$ if $s \geq 0$ is an integer. Prove that the respective norms are bounded above and below by constant multiples of each other.
9. (a) Prove for each s that the operator $A_s(T) = \mathcal{F}^{-1}((1 + |\xi|^2)^{s/2} \mathcal{F}(T))$ is a linear isometry of H^s onto $H^0 \cong L^2$, and conclude that the inner-product space H^s is a Hilbert space.
 - (b) Prove that A_s^{-1} carries the subspace $\mathcal{S}(\mathbb{R}^N)$ of Schwartz functions, i.e., tempered distributions of the form T_φ with $\varphi \in \mathcal{S}(\mathbb{R}^N)$, onto itself.
 - (c) Prove that $\mathcal{S}(\mathbb{R}^N)$ is dense in H^s for all s .
10. Suppose that T is in H^{-s} and φ is in $\mathcal{S}(\mathbb{R}^N) \subseteq H^s$. Prove that $|\langle T, \varphi \rangle| \leq \|T\|_{H^{-s}} \|\varphi\|_{H^s}$.
11. Conversely suppose that s is real and that T is a tempered distribution such that $|\langle T, \varphi \rangle| \leq C \|\varphi\|_{H^s}$ for all $\varphi \in \mathcal{S}(\mathbb{R}^N)$. Show that $\mathcal{F}(T)$ defines a bounded linear functional on the Hilbert space $L^2(\mathbb{R}^N, (1 + |\xi|^2)^s d\xi)$, and deduce that T is in H^{-s} with $\|T\|_{-s} \leq C$.
12. Let $s > N/2$.
 - (a) Prove that if the tempered distribution T given by the function $\varphi \in \mathcal{S}(\mathbb{R}^N)$ is regarded as a member T_φ of H^s , then $\|\varphi\|_{\text{sup}} \leq \|\mathcal{F}(\varphi)\|_1 \leq C \|T_\varphi\|_{H^s}$, where C is the constant $(\int_{\mathbb{R}^N} (1 + |\xi|^2)^{-s} d\xi)^{1/2}$ independent of φ .
 - (b) (**Sobolev’s Theorem**) Deduce from (a) that any member T of H^s with $s > N/2$ is given by a bounded continuous function.
 - (c) Extend the above argument to show for each integer $m \geq 0$ that any member T of H^s with $s > N/2 + m$ is given by a function of class C^m .

Problems 13–20 concern the **Hardy spaces** $H^p(\mathbb{R}_+^2)$ for the upper half plane $\mathbb{R}_+^2 = \{z \in \mathbb{C} \mid \text{Im } z > 0\}$. These problems use complex analysis in one variable, and some familiarity with the Poisson and conjugate Poisson kernels as in Chapters VIII and IX of *Basic* will be helpful. The space $H^p(\mathbb{R}_+^2)$ is defined to be the vector subspace of analytic functions in the space $\mathcal{H}^p(\mathbb{R}_+^2)$. Let f^* be the Hardy–Littlewood maximal function of f on \mathbb{R}^1 . Take as known the result from *Basic* that the Poisson integral $P_y * f$ satisfies $|P_y * f(x)| \leq C f^*(x)$ with C independent of f and y .

13. Suppose that p satisfies $1 < p < \infty$, and let $H : L^p(\mathbb{R}^1) \rightarrow L^p(\mathbb{R}^1)$ be the Hilbert transform.

(a) Prove that if $u_0(x)$ is in $L^p(\mathbb{R}^1)$, then the Poisson integral of the function $u_0(x) + i(Hu_0)(x)$ is in $H^p(\mathbb{R}_+^2)$.

(b) Conversely suppose that $f(x + iy)$ is in $H^p(\mathbb{R}_+^2)$. Applying Theorem 3.25, let $f(x + iy)$ be the Poisson integral of the member $f_0(x)$ of $L^p(\mathbb{R}_+^1)$. If $\text{Re } f_0 = u_0$, prove that $\text{Im } f_0 = Hu_0$.

14. Prove that the functions f in $L^2(\mathbb{R}^1)$ whose Poisson integrals are in the subspace $H^2(\mathbb{R}_+^2)$ of $\mathcal{H}^2(\mathbb{R}_+^2)$ are exactly the functions for which $\mathcal{F}f(x) = 0$ a.e. for $x < 0$.

15. Let $F = (f_1, \dots, f_n)$ be an n -tuple of analytic functions on an open subset of \mathbb{C} , and let (\cdot, \cdot) be the usual inner product on \mathbb{C}^n . For a function on an open set in \mathbb{C} , define $f_z = \frac{1}{2}(f_x - if_y)$ and $f_{\bar{z}} = \frac{1}{2}(f_x + if_y)$, so that the condition for analyticity is $f_{\bar{z}} = 0$ and so that $\Delta f = 4f_{z\bar{z}}$. Suppose that F is nowhere 0 on an open set. Prove for all $q > 0$ that

$$\begin{aligned} \Delta(|F|^q) &= q^2|F|^{q-4}|(F, F')|^2 + 2q|F|^{q-4}(-|(F, F')|^2 + |F|^2|F'|^2) \\ &\geq q^2|F|^{q-4}|(F, F')|^2 \geq 0. \end{aligned}$$

16. Suppose that u is a smooth real-valued function on an open set in \mathbb{R}^N containing the ball $B(r; x_0)^{\text{cl}}$ such that $\Delta u \geq 0$ on $B(r; x_0)$ and $u \leq 0$ on $\partial B(r; x_0)$. By considering $u + c(|x - x_0|^2 - r^2)$ for a suitable c , prove that $u \leq 0$ on $B(r; x_0)^{\text{cl}}$.

17. Let f be in $H^1(\mathbb{R}_+^2)$, and define $F_\varepsilon : \{\text{Im } z \geq 0\} \rightarrow \mathbb{C}^2$ for $\varepsilon > 0$ by $F_\varepsilon(z) = (f(z + i\varepsilon), \varepsilon(z + i)^{-2})$. Define $g_\varepsilon(x) = |F_\varepsilon(x)|^{1/2}$ for $x \in \mathbb{R}$.

(a) Prove that $\|g_\varepsilon\|_2^2 \leq \|f\|_{H^1} + \varepsilon\|(x + i)^{-2}\|_1$.

(b) Let $g_\varepsilon(z)$ be the Poisson integral of $g_\varepsilon(x)$. Show that $|F_\varepsilon(z)|^{1/2}$ and $g_\varepsilon(z)$ both tend to 0 as $|x|$ or y tends to infinity in \mathbb{R}_+^2 .

(c) By applying the previous two problems to $|F_\varepsilon(z)|^{1/2} - g_\varepsilon(z)$ on large disks in \mathbb{R}_+^2 , prove that $|F_\varepsilon(z)|^{1/2} \leq g_\varepsilon(z)$ on \mathbb{R}_+^2 .

18. By Alaoglu's Theorem let $g(x)$ be a weak-star limit in $L^2(\mathbb{R}^1)$ of a sequence $g_{\varepsilon_n}(x)$ with $\varepsilon_n \downarrow 0$, and let $g(z)$ be the Poisson integral of $g(x)$.

(a) Prove that $|f(z)|^{1/2} \leq g(z) \leq Cg^*(x)$, with $g^*(x)$ being the Hardy–Littlewood maximal function of $g(x)$.

- (b) Conclude that $|f(x + iy)|$ is dominated by the fixed integrable function $g^*(x)^2$ as $y \downarrow 0$.
19. Let X be a locally compact separable metric space, let μ be a finite Borel measure on X , and suppose that $\{g_n\}$ is a sequence of Borel functions on X with $|g_n| \leq 1$ such that the sequence $\{g_n(x) d\mu(x)\}$ of complex Borel measures converges weak-star against $C_{\text{com}}(X)$ to a complex Borel measure ν . Prove that ν is absolutely continuous with respect to μ .
20. **(F. and M. Riesz Theorem)** Deduce from the above facts that each member of $H^1(\mathbb{R}_+^2)$ is the Poisson integral of an L^1 function on \mathbb{R}^1 .

Problems 21–24 show that the limit $Tf = \lim_{\varepsilon \downarrow 0} T_\varepsilon f$ defining a Calderón–Zygmund operator T exists almost everywhere for $f \in L^p$ and $1 < p < \infty$, as well as in L^p . Let notation be as in the statement of Theorem 3.26 and Lemma 3.29: $K(x)$ is a C^1 function on $\mathbb{R}^N - \{0\}$ homogeneous of degree 0 with mean value 0 over the unit sphere, $k(x)$ is $K(x)/|x|^N$ for $|x| \geq 1$ and is 0 for $|x| < 1$. For any function φ on \mathbb{R}^N , define $\varphi_\varepsilon(x) = \varepsilon^{-N} \varphi(\varepsilon^{-1}x)$. The operator $T_\varepsilon f$ is $k_\varepsilon * f$. Let f^* be the Hardy–Littlewood maximal function of f . Take as known from *Basic* that if $\Psi \geq 0$ is an integrable function on \mathbb{R}^N of the form $\Psi(x) = \Psi_0(|x|)$ with Ψ_0 nonincreasing and finite at 0, then $\sup_{\varepsilon > 0} (\Psi_\varepsilon * f)(x) \leq C_\Psi f^*(x)$ for some finite constant C_Ψ . Let f be in L^p with $1 < p < \infty$.

21. Let φ be as in Proposition 3.5e. Define $\Phi = T(\varphi) - k$.
- Taking into account the fact that φ is in $C_{\text{com}}^\infty(\mathbb{R}^N)$, prove that $T(\varphi)$ is in $C^\infty(\mathbb{R}^N)$, and conclude that Φ is locally bounded.
 - By taking into account the compact support of φ , prove that $|\Phi(x)|$ is bounded by a multiple of $|x|^{-N-1}$ for large $|x|$.
 - Deduce that $|\Phi(x)|$ is dominated for all x by an integrable function $\Psi(x)$ on \mathbb{R}^N of the form $\Psi(x) = \Psi_0(|x|)$ with Ψ_0 nonincreasing and finite at 0.
22. Let φ and Φ be as in the previous problem.
- Prove that $(T\varphi)_\varepsilon = T\varphi_\varepsilon$.
 - Prove the associativity formula $T\varphi_\varepsilon * f = \varphi_\varepsilon * (Tf)$.
 - Deduce that $\varphi_\varepsilon * (Tf) - k_\varepsilon * f = \Phi_\varepsilon * f$.
23. Conclude from the previous problem that there are constants C_1 and C_2 independent of f such that $\sup_{\varepsilon > 0} |T_\varepsilon f(x)| \leq C_1 f^*(x) + C_2 (Tf)^*(x)$.
24. Why does it follow that $\lim_{\varepsilon \downarrow 0} T_\varepsilon f(x)$ exists almost everywhere?

Problems 25–34 introduce Sobolev spaces in the context of multiple Fourier series. In this set of problems, periodic functions are understood to be defined on \mathbb{R}^N and to be periodic of period 2π in each variable. Write T for the circle $\mathbb{R}/2\pi\mathbb{Z}$, and let $C^\infty(T^N)$ be the complex vector space of all smooth periodic functions. Let $L^2(T^N)$ be the space of all periodic functions (modulo functions that are 0 almost everywhere) that are in $L^2([-\pi, \pi]^N)$. If $\alpha = (\alpha_1, \dots, \alpha_N)$ is a multi-index, a member f of $L^2(T^N)$

is said to have a **weak** α^{th} **derivative** in $L^2(T^N)$ if there exists a function $D^\alpha f$ in $L^2(T^N)$ with

$$\int_{[-\pi, \pi]^N} (D^\alpha f) \varphi \, dx = (-1)^{|\alpha|} \int_{[-\pi, \pi]^N} f D^\alpha \varphi \, dx$$

for all φ in $C^\infty(T^N)$. Define the **Sobolev space** $L_k^2(T^N)$ for each integer $k \geq 0$ to consist of all members of $L^2(T^N)$ having α^{th} derivative in $L^2(T^N)$ for all α with $|\alpha| \leq k$. The norm on $L_k^2(T^N)$ is given by

$$\|f\|_{L_k^2(T^N)}^2 = \sum_{|\alpha| \leq k} (2\pi)^{-N} \int_{[-\pi, \pi]^N} |D^\alpha f|^2 \, dx.$$

25. Prove that $L_k^2(T^N)$ is complete.

26. Prove that $C^\infty(T^N)$ is dense in $L_k^2(T^N)$ for all $k \geq 0$.

27. Prove for each multi-index α and each $k \geq 0$ that there exists a constant $C_{\alpha, k}$ such that

$$\|D^\alpha f\|_{L_k^2(T^N)} \leq C_{\alpha, k} \|f\|_{L_{k+|\alpha|}^2(T^N)}$$

for all f in $C^\infty(T^N)$.

28. Prove for each $k \geq 0$ that there is a constant A_k such that every member f of $L_k^2(T^N)$ has

$$\|f\|_{L_k^2(T^N)} \leq A_k \sum_{|\alpha| \leq k} \sup_{x \in [-\pi, \pi]^N} |D^\alpha f(x)|.$$

29. Prove for each integer $k \geq 0$ that there exist positive constants B_k and C_k such that $B_k \sum_{|\alpha| \leq k} l^{2\alpha} \leq (1 + |l|^2)^k \leq C_k \sum_{|\alpha| \leq k} l^{2\alpha}$.

30. Prove that if f is periodic and locally integrable on \mathbb{R}^N with multiple Fourier series $f(x) \sim \sum_{l \in \mathbb{Z}^N} c_l e^{il \cdot x}$, then f is in $L_k^2(T^N)$ if and only if

$$\sum_{l \in \mathbb{Z}^N} |c_l|^2 (1 + |l|^2)^k < \infty.$$

31. With notation as in the previous problem, prove for each $k \geq 0$ that there exist positive constants B_k and C_k independent of f such that

$$B_k \|f\|_{L_k^2(T^N)}^2 \leq \sum_{l \in \mathbb{Z}^N} |c_l|^2 (1 + |l|^2)^k \leq C_k \|f\|_{L_k^2(T^N)}^2$$

for all f in $L_k^2(T^N)$.

32. (**Sobolev's Theorem**) Suppose that K is an integer with $K > N/2$. Prove that $\sum_{l \in \mathbb{Z}^N} (1 + |l|^2)^{-K} < \infty$, and deduce that any f in $L_K^2(T^N)$ can be adjusted on a set of measure 0 so as to be continuous.

33. Prove for each multi-index α that there exist some integer $m(\alpha)$ and constant C_α such that

$$\sup_{x \in [-\pi, \pi]} |D^\alpha f(x)| \leq C_\alpha \|f\|_{L^2_{m(\alpha)}(T^N)}$$

for all f in $C^\infty(T^N)$.

34. Prove that the separating family of seminorms $\|\cdot\|_{L^2_k(T^N)}$ on $C^\infty(T^N)$, indexed by k , is equivalent to the family of seminorms $\sup_{x \in [-\pi, \pi]^N} |D^\alpha(\cdot)(x)|$, indexed by α . Here “is equivalent to” is to mean that the identity map is uniformly continuous from the one metric space to the other.

CHAPTER IV

Topics in Functional Analysis

Abstract. This chapter pursues three lines of investigation in the subject of functional analysis—one involving smooth functions and distributions, one involving fixed-point theorems, and one involving spectral theory.

Section 1 introduces topological vector spaces. These are real or complex vector spaces with a Hausdorff topology in which addition and scalar multiplication are continuous. Examples include normed linear spaces, spaces given by a separating family of countably many seminorms, and weak and weak-star topologies in the context of Banach spaces. Various general properties of topological vector spaces are proved, and it is proved that the quotient of a topological vector space by a closed vector subspace is Hausdorff and is therefore a topological vector space.

Section 2 introduces a topology on the space $C^\infty(U)$ of smooth functions on an open subset of \mathbb{R}^N . The support of a continuous linear functional on $C^\infty(U)$ is defined and shown to be a compact subset of U . Accordingly, the continuous linear functionals are called distributions of compact support.

Section 3 studies weak and weak-star topologies in more detail. The main result is Alaoglu's Theorem, which says that the closed unit ball in the weak-star topology on the dual of a normed linear space is compact. In an earlier chapter a preliminary form of this theorem was used to construct elements in a dual space as limits of weak-star convergent subsequences.

Section 4 follows Alaoglu's Theorem along a particular path, giving what amounts to a first example of the Gelfand theory of Banach algebras. The relevant theorem, known as the Stone Representation Theorem, says that conjugate-closed uniformly closed subalgebras containing the constants in $B(S)$ are isomorphic via a norm-preserving algebra isomorphism to the space of all continuous functions on some compact Hausdorff space. The compact space in question is the space of multiplicative linear functionals on the subalgebra, and the proof of compactness uses Alaoglu's Theorem.

Sections 5–6 return to the lines of study toward distributions and fixed-point theorems. Section 5 studies the relationship between convexity and the existence of separating linear functionals. The main theorem makes use of the Hahn–Banach Theorem. Section 6 introduces locally convex topological vector spaces. Application of the basic separation theorem from the previous section shows the existence of many continuous linear functionals on such a space.

Section 7 specializes to the line of study via smooth functions and distributions. The topic is the introduction of a certain locally convex topology on the space $C_{\text{com}}^\infty(U)$ of smooth functions of compact support on U . This is best characterized by a universal mapping property introduced in the section.

Sections 8–9 pursue locally convex spaces along the other line of study that split off in Section 5. Section 8 gives the Krein–Milman Theorem, which asserts the existence of a supply of extreme points for any nonempty compact convex set in a locally convex topological vector space. Section 9 relates compact convex sets to the subject of fixed-point theorems.

Section 10 takes up the abstract theory of Banach algebras, with particular attention to commutative C^* algebras with identity. Three examples are the algebras characterized by the Stone Representation Theorem, any L^∞ space, and any adjoint-closed commutative Banach algebra consisting of bounded linear operators on a Hilbert space and containing the identity.

Section 11 continues the investigation of the last of the examples in the previous section and derives the Spectral Theorem for bounded self-adjoint operators and certain related families of operators. Powerful applications follow from a functional calculus implied by the Spectral Theorem. The section concludes with remarks about the Spectral Theorem for unbounded self-adjoint operators.

1. Topological Vector Spaces

In this section we shall work with vector spaces over \mathbb{R} or \mathbb{C} , and the distinction between the two fields will not be very important. We write \mathbb{F} for this field of scalars. A **topological vector space** or **linear topological space** is a vector space X over \mathbb{F} with a Hausdorff topology such that addition, as a mapping $X \times X \rightarrow X$, and scalar multiplication, as a mapping $\mathbb{F} \times X \rightarrow X$, are continuous. The mappings that we study between topological vector spaces are the continuous linear functions, which may be referred to as “continuous linear operators.” An **isomorphism** of topological vector spaces over \mathbb{F} is a continuous linear operator with a continuous inverse.

The simplest examples of topological vector spaces are the spaces \mathbb{F}^N of column vectors with the usual metric topology. Since the topologies of \mathbb{F}^N , $\mathbb{F}^N \times \mathbb{F}^N$, and $\mathbb{F} \times \mathbb{F}^N$ are given by metrics, continuity of functions defined on any of these spaces may be tested by sequences. In particular, continuity of the vector-space operations on \mathbb{F}^N reduces to the familiar results about limits of sums of vectors and limits of scalars times vectors. Moreover, if $L : \mathbb{F}^N \rightarrow Y$ is any linear function from \mathbb{F}^N into a topological vector space over \mathbb{F} , then L is continuous. To see this, let $\{e_1, \dots, e_N\}$ be the standard basis of column vectors, and let (\cdot, \cdot) be the standard inner product on \mathbb{F}^N , namely the dot product if $\mathbb{F} = \mathbb{R}$ and the usual Hermitian inner product if $\mathbb{F} = \mathbb{C}$. Write $y_j = L(e_j)$. For any x in \mathbb{F}^N , we have

$$L(x) = \sum_{j=1}^N (x, e_j)L(e_j) = \sum_{j=1}^N (x, e_j)y_j.$$

If $\{x_n\}$ is a sequence converging to x in \mathbb{F}^N , then the continuity of the inner product forces $(x_n, e_j) \rightarrow (x, e_j)$ for each j . Then $L(x_n)$ tends to $L(x)$ in Y since the vector space operations are continuous in Y . Hence L is continuous.

A second class of examples is the class of normed linear spaces. These were defined in *Basic*, and the continuity of the operations was established there.¹ The spaces \mathbb{F}^N of column vectors are examples. Further examples include the space $B(S)$ of all bounded scalar-valued functions on a nonempty set S with the supremum norm, the vector subspace $C(S)$ of continuous members of $B(S)$ when S is a topological space, the vector subspaces $C_{\text{com}}(S)$ and $C_0(S)$ of continuous functions of compact support and of continuous functions vanishing at infinity when S is locally compact Hausdorff, the space $L^p(X, \mu)$ for $1 \leq p \leq \infty$ when (X, μ) is a measure space, and the space $M(S)$ of finite regular Borel complex measures on a locally compact Hausdorff space with the total variation norm.

A wider class of examples, which includes the normed linear spaces, is the class of topological vector spaces defined by seminorms. Seminorms were defined in Section III.1. If we have a family $\{\|\cdot\|_s\}$ of seminorms on a vector space X over \mathbb{F} , with indexing given by s in some nonempty set S , the corresponding topology on X is defined as the weak topology determined by all functions $x \mapsto \|x - y\|_s$ for $s \in S$ and $y \in X$. A base for the open sets of X is obtained as follows: For each triple (y, s, r) , with y in X , with s one of the seminorm indices, and with $r > 0$, the set $\{x \mid \|x - y\|_s < r\}$ is to be in the base, and the base consists of all finite intersections of these sets as (y, s, r) varies.

In order to obtain a topological vector space from a system of seminorms, we must ensure the Hausdorff property, and we do so by insisting that the only f in X with $\|f\|_s = 0$ for all s is $f = 0$. In this case the family of seminorms is called a **separating family**. Let us go through the argument that a space defined by a separating family of seminorms is a topological vector space.

Proposition 4.1. Let X be a vector space over \mathbb{F} endowed with a separating family $\{\|\cdot\|_s\}$ of seminorms. Then the weak topology determined by all functions $x \mapsto \|x - y\|_s$ makes X into a topological vector space.

PROOF. To see that X is Hausdorff, let x_0 and y_0 be distinct points of X . By assumption, there exists some s such that $\|x_0 - y_0\|_s$ is a positive number r . The sets $\{x \mid \|x - x_0\|_s < r/2\}$ and $\{y \mid \|y - y_0\|_s < r/2\}$ are disjoint and open, and they contain x_0 and y_0 , respectively. Hence X is Hausdorff.

To see that addition is continuous, we are to show that if a net $\{(x_\alpha, y_\alpha)\}$ is convergent in $X \times X$ to (x_0, y_0) , then $\{x_\alpha + y_\alpha\}$ converges to $x_0 + y_0$. This means that if $\|x_\alpha - x_0\|_s + \|y_\alpha - y_0\|_s$ tends to 0 for each s , then $\|(x_\alpha + y_\alpha) - (x_0 + y_0)\|_s$ tends to 0 for each s . This is immediate from the triangle inequality for the seminorm $\|\cdot\|_s$, and hence addition is continuous. The proof that scalar multiplication is continuous is similar. \square

¹The definition appears in Section V.9 of *Basic*, and the continuity of the operations is proved in Proposition 5.55.

We have encountered two distinctly different kinds of examples of topological vector spaces defined by families of seminorms. In the first kind a countable family of seminorms suffices to define the topology. Normed linear spaces are examples. So is the Schwartz space $\mathcal{S}(\mathbb{R}^N)$, consisting of all smooth scalar-valued functions on \mathbb{R}^N such that the product of any polynomial with any iterated partial derivative of the function is bounded. The defining seminorms for the Schwartz space are

$$\|f\|_{P,Q} = \sup_{x \in \mathbb{R}^N} |P(x)(Q(D)f)(x)|,$$

where P and Q are arbitrary polynomials. We saw in Section III.1 that the same topology arises if we use only the countably many seminorms for which P is some monomial x^α and Q is some monomial x^β . This family of seminorms is a separating family because if $\|f\|_{1,1} = 0$, then $f = 0$.

Another example of a topological vector space whose topology can be defined by countably many seminorms is the space $C^\infty(U)$ of smooth scalar-valued functions on a nonempty open set U of \mathbb{R}^N with the topology of uniform convergence on compact sets of all derivatives. The family of seminorms is indexed by pairs (K, P) with K a compact subset of U and with P a polynomial, the corresponding seminorm being $\|f\|_{K,P} = \sup_{x \in K} |(P(D)f)(x)|$. The Hausdorff condition is satisfied because if $\|f\|_{K,1} = 0$ for all K , then $f = 0$. We shall see in the next section that the topology can be defined by a countable subfamily of these seminorms.

Still a third space of smooth scalar-valued functions, besides $\mathcal{S}(\mathbb{R}^N)$ and $C^\infty(U)$, will be of interest to us. This is the space $C_{\text{com}}^\infty(U)$ of smooth functions on a nonempty open U with compact support contained in U . The useful topology on this space is more complicated than the topologies considered so far. In particular, it cannot be given by countably many seminorms. Describing the topology requires some preparation, and we come back to the details in Section 7.

The examples we have encountered of topological vector spaces defined by an uncountable family of seminorms, but not definable by a countable family, are qualitatively different from the examples above. Indeed, they lead along a different theoretical path, as we shall see—one that takes us in the direction of spectral theory rather than distribution theory.

The first class of such examples is the class of normed linear spaces X with the “weak topology,” as contrasted with the norm topology. Let X^* be the set of linear functionals of X that are continuous in the norm topology. The **weak topology** on X was defined in Chapter X of *Basic* as the weakest topology that makes all members of X^* continuous. Of course, any set that is open in the weak topology on X is open in the norm topology. A base for the open sets in the weak topology on X is obtained as follows: For each triple (x_0, x^*, r) , with x_0 in X , x^* in X^* , and $r > 0$, the set $\{x \mid |x^*(x - x_0)| < r\}$ is to be in the base, and the base

consists of all finite intersections of these sets as (x_0, x^*, r) varies. The weak topology is given by the family of seminorms $\|\cdot\|_{x^*} = |x^*(\cdot)|$. The proof that the weak topology is Hausdorff requires the fact, for each $x \neq 0$ in X , that there is some member x^* with $x^*(x) \neq 0$; this fact is one of the standard corollaries of the Hahn–Banach Theorem. Examples of weak topologies will be discussed in Section 3.

Similarly the weak-star topology on X^* , when X is a normed linear space, was defined in *Basic* as the weakest topology on X^* that makes all members of X continuous. This is given by the family of seminorms $\|\cdot\|_x = |\cdot(x)|$. Here the relevant fact for seeing that the topology is Hausdorff is that for each $x^* \neq 0$ in X^* , there is some x in X with $x^*(x) \neq 0$. This is just a matter of the definition of $x^* \neq 0$ and depends on no theorem. Examples of weak-star topologies will be discussed in Section 3.

The above classes of examples by no means exhaust the possibilities for topological vector spaces. Let us mention briefly one example that is not even close to being definable by seminorms. It is the space $L^p([0, 1])$ with $0 < p < 1$. This is the vector space of all real-valued Borel functions on $[0, 1]$ with $\int_{[0,1]} |f|^p dx$ finite, except that we identify two functions if they differ only on a set of measure 0. Let us see that $d(f, g) = \int_{[0,1]} |f - g|^p dx$ is a metric. We need only verify the triangle inequality in the form $\int_{[0,1]} |f + g|^p dx \leq \int_{[0,1]} |f|^p dx + \int_{[0,1]} |g|^p dx$. To check this, we observe for nonnegative r that $(1+r)^p - (1+r^p)$ is 0 at $r = 0$ and has negative derivative $p((1+r)^{p-1} - r^{p-1})$ since $p - 1$ is negative. Thus $(1+r)^p \leq 1+r^p$ for $r \geq 0$, and consequently $|a+b|^p \leq (|a|+|b|)^p \leq |a|^p + |b|^p$ for all real a and b . Taking $a = f(x)$ and $b = g(x)$ and integrating, we obtain the desired triangle inequality. One readily shows that $L^p([0, 1])$ with this metric is a topological vector space. On the other hand, this topological vector space is rather pathological, as is shown in Problem 8 at the end of the chapter. For example it has no nonzero continuous linear functionals, whereas nonzero topological vector spaces whose topologies are given by seminorms always have enough continuous linear functionals to separate points.²

Now we turn our attention to a few results valid for arbitrary topological vector spaces.

Proposition 4.2. In any topological vector space, the closure of any vector subspace is a vector subspace.

PROOF. Let V be a vector subspace of the topological vector space X . If x and y are in V^{cl} , then (x, y) is in $V^{\text{cl}} \times V^{\text{cl}} = (V \times V)^{\text{cl}}$. Any continuous function

²More precisely it will be observed in Section 6 that topological vector spaces whose topologies are given by seminorms are “locally convex,” and it will be proved in that same section that locally convex spaces always have enough continuous linear functionals to separate points.

f has the property for any set S that $f(S^{\text{cl}}) \subseteq f(S)^{\text{cl}}$. Applying this fact to the addition function, we see that $x + y$ is in V^{cl} since V is the image of $V \times V$ under addition. Thus V^{cl} is closed under addition. Similarly V^{cl} is closed under scalar multiplication. \square

Lemma 4.3. If X is a real or complex vector space in which addition and scalar multiplication are continuous and if $\{0\}$ is a closed subset of X , then X is Hausdorff and hence is a topological vector space.

PROOF. Since translations are homeomorphisms, it is enough to separate 0 and an arbitrary $x \neq 0$ by disjoint open neighborhoods. Since $X - \{0\}$ is open, so is $V = X - \{x\}$. By continuity of subtraction, choose an open neighborhood U of 0 such that the set of differences satisfies $U - U \subseteq V$. Then U and $x + U$ are open neighborhoods of 0 and x . If y is in their intersection, then y is in U , and y is of the form $x + u$ for some u in U . Hence $x = y - u$ exhibits x as in $U - U \subseteq V = X - \{x\}$, contradiction. Thus we can take U and $x + U$ as the required disjoint open neighborhoods of 0 and x . \square

Proposition 4.4. If X is a topological vector space, if Y is a closed vector subspace, and if the quotient vector space X/Y is given the quotient topology,³ then X/Y is a topological vector space, and the quotient map $q : X \rightarrow X/Y$ carries open sets to open sets.

PROOF. If U is open in X , then $q^{-1}(q(U)) = \bigcup_{y \in Y} (y + U)$ exhibits $q^{-1}(q(U))$ as the union of open sets and hence as an open set. By definition of the topology on X/Y , $q(U)$ is open in X/Y . Hence q carries open sets in X to open sets in X/Y .

To see that addition is continuous in X/Y , let x_1 and x_2 be in X , and let E be an open neighborhood of the member $x_1 + x_2 + Y$ of X/Y . Then $q^{-1}(E)$ is an open neighborhood of $x_1 + x_2$ in X . By continuity of addition in X , there exist open neighborhoods U_1 of x_1 and U_2 of x_2 such that $U_1 + U_2 \subseteq q^{-1}(E)$. The map q is open and linear, and hence $q(U_1)$ and $q(U_2)$ are open subsets of X/Y with $q(U_1) + q(U_2) \subseteq q(q^{-1}(E)) = E$. Thus addition is continuous in X/Y .

To see that scalar multiplication is continuous in X/Y , let c be a scalar, let x be in X , and let E be an open neighborhood of cx in X/Y . Then $q^{-1}(E)$ is an open neighborhood of cx in X . By continuity of scalar multiplication in X , there exist open neighborhoods A of c in the scalars and U of x in X such that $AU \subseteq q^{-1}(E)$. Then $q(U)$ is an open subset of X/Y such that $Aq(U) \subseteq q(q^{-1}(E)) = E$. Hence scalar multiplication is continuous in X/Y .

Applying Lemma 4.3, we see that X/Y is Hausdorff. Therefore X/Y is a topological vector space. \square

³If $q : X \rightarrow X/Y$ is the quotient mapping, the open sets E of X/Y are defined as all subsets such that $q^{-1}(E)$ is open in X .

Proposition 4.5. If Y is an n -dimensional topological vector space over \mathbb{F} , then Y is isomorphic to \mathbb{F}^n .

PROOF. Let y_1, \dots, y_n be a vector-space basis of Y , and let (\cdot, \cdot) and $|\cdot|$ be the usual inner product and norm on \mathbb{F}^n . If e_1, \dots, e_n is the standard basis of \mathbb{F}^n , define $L(\sum_{j=1}^n c_j e_j) = \sum_{j=1}^n c_j y_j$. Then L is one-one and hence is onto Y . We saw earlier in this section that L is continuous. We shall prove that L^{-1} is continuous, and it is enough to do so at 0 in Y .

Assuming on the contrary that L^{-1} is not continuous at 0, we can find some $\epsilon > 0$ such that no open neighborhood U of 0 in Y maps under L^{-1} into the open neighborhood $\{|x| < \epsilon\}$ of 0 in \mathbb{F}^n . For each such U , find y_U in U with $|L^{-1}(y_U)| \geq \epsilon$. Define $z_U = |L^{-1}(y_U)|^{-1} y_U$. The net $\{y_U\}$ tends to 0 in Y by construction, and the numbers $|L^{-1}(y_U)|^{-1}$ are bounded by ϵ^{-1} . By continuity of scalar multiplication in Y , z_U has limit 0 in Y . On the other hand, the members of \mathbb{F}^n defined by $x_U = L^{-1}(z_U) = |L^{-1}(y_U)|^{-1} L^{-1}(y_U)$ have $|x_U| = 1$ for all U . The unit sphere in \mathbb{F}^n is compact, and it follows that $\{x_U\}$ has a convergent subnet, say $\{x_{U_\mu}\}$, with some limit x_0 such that $|x_0| = 1$. We have $L(x_U) = z_U$, and passage to the limit gives $L(x_0) = \lim_\mu L(x_{U_\mu}) = \lim_\mu z_{U_\mu} = 0$. On the other hand, L is one-one, and hence the equality $L(x_0) = 0$ for some x_0 with $|x_0| = 1$ is a contradiction. We conclude that L^{-1} is continuous. \square

Corollary 4.6. Every finite-dimensional vector subspace of a topological vector space is closed.

PROOF. Let V be an n -dimensional subspace of a topological vector space X , and suppose that V^{cl} properly contains V . Choose x_0 in $V^{\text{cl}} - V$, and form the vector subspace $W = V + \mathbb{F}x_0$. Then the closure of V in W , being a vector subspace (Proposition 4.2), is W . The vector subspace W has dimension $n + 1$, and Proposition 4.5 shows that W is isomorphic to \mathbb{F}^{n+1} . All vector subspaces of \mathbb{F}^{n+1} are closed in \mathbb{F}^{n+1} , and hence V is closed in W , contradiction. \square

Lemma 4.7. If X is a topological vector space, K is a compact subset of X , and V is an open neighborhood of 0, then there exists $\epsilon > 0$ such that $\delta K \subseteq V$ whenever $|\delta| \leq \epsilon$.

PROOF. For each $k \in K$, choose $\epsilon_k > 0$ and an open neighborhood U_k of k such that $\delta U_k \subseteq V$ whenever $|\delta| \leq \epsilon_k$; this is possible since scalar multiplication is continuous at the point where the scalar is 0 and the vector is k . The open sets U_k cover K , and the compactness of K implies that there is a finite subcover: $K \subseteq U_{k_1} \cup \dots \cup U_{k_m}$. Then $\delta K \subseteq V$ whenever $|\delta| \leq \min_{1 \leq j \leq m} \epsilon_{k_j}$. \square

Proposition 4.8. Every locally compact topological vector space is finite dimensional.

PROOF. Let X be a locally compact topological vector space, let K be a compact neighborhood of 0 , and let U be its interior. Suppose that we have a sequence $\{y_m\}$ in X with the property that for any $\delta > 0$, there is an integer M such that $m \geq M$ implies y_m lies in δK . Then the result of Lemma 4.7 implies that $\{y_m\}$ tends to 0 .

The sets $\{k + \frac{1}{2}U \mid k \in K\}$ form an open cover of K . If $\{k_1 + \frac{1}{2}U, \dots, k_n + \frac{1}{2}U\}$ is a finite subcover, we prove that $\{k_1, \dots, k_n\}$ spans X . It is enough to prove that $S = \{k_1, \dots, k_n\}$ spans U . If x is in U , then x is in one of the sets of the finite subcover, say $k_{j_1} + \frac{1}{2}U$. Write $x = k_{j_1} + \frac{1}{2}u_1$ accordingly. The finite subcover covers K and hence its interior U , and thus $\frac{1}{2}U$ is covered by $\frac{1}{2}(k_1 + \frac{1}{2}U), \dots, \frac{1}{2}(k_n + \frac{1}{2}U)$. Applying this observation to the element $\frac{1}{2}u_1$ of $\frac{1}{2}U$, we see that x is in $k_{j_1} + \frac{1}{2}(k_{j_2} + \frac{1}{2}U)$ for some k_{j_2} . Write $x = k_{j_1} + \frac{1}{2}k_{j_2} + \frac{1}{4}u_2$ accordingly. Continuing in this way, we see that

$$x \quad \text{is in} \quad k_{j_1} + \frac{1}{2}k_{j_2} + \dots + \frac{1}{2^{r-1}}k_{j_r} + \frac{1}{2^r}U \quad \text{for each } r.$$

Put $x_r = k_{j_1} + \frac{1}{2}k_{j_2} + \dots + \frac{1}{2^{r-1}}k_{j_r}$. This is an element of the finite-dimensional subspace spanned by S , which is closed by Corollary 4.6; thus if $\{x_r\}$ converges, it must converge to a member x_0 of this subspace. Using the result of the previous paragraph, we shall show that $x - x_r$ converges to 0 . Then we can conclude that x_r converges to x , hence that x is in the span of S . To see that $x - x_r$ converges to 0 , choose l such that $|\delta_0| \leq 2^{-l}$ implies $\delta_0 K \subseteq U$. Applying the criterion of the previous paragraph, let $\delta > 0$ be given. Choose M such that $2^{-M}\delta^{-1} \leq 2^{-l}$. Then $m \geq M$ implies that $2^{-m}\delta^{-1} \leq 2^{-M}\delta^{-1} \leq 2^{-l}$. Thus $2^{-m}\delta^{-1}$ is an allowable choice of δ_0 , and we therefore obtain $2^{-m}\delta^{-1}K \subseteq U$ and $2^{-m}K \subseteq \delta U$. For $m \geq M$, the element $x - x_m$ lies in $2^{-m}U \subseteq 2^{-m}K$, and we have just proved that $2^{-m}K \subseteq \delta U$. Thus $x - x_m$ lies in δU , and the criterion of the previous paragraph applies. Hence $x - x_m$ tends to 0 . This completes the proof. \square

2. $C^\infty(U)$, Distributions, and Support

As was mentioned in Section III.1, distributions are continuous linear functionals on vector spaces of smooth functions. Their properties are deceptively simple-looking and enormously helpful in working with linear partial differential equations. We considered tempered distributions in Section III.1; these are the continuous linear functionals on the space $\mathcal{S}(\mathbb{R}^N)$ of Schwartz functions on \mathbb{R}^N . In this section we study the topology on the space $C^\infty(U)$ of arbitrary scalar-valued smooth functions on an open subset U of \mathbb{R}^N , together with the associated space of distributions.

To topologize $C^\infty(U)$, we use the family of seminorms indexed by pairs (K, P) with K a compact subset of U and with P a polynomial, the $(K, P)^{\text{th}}$ seminorm

being $\|f\|_{K,P} = \sup_{x \in K} |(P(D)f)(x)|$. The resulting topology is Hausdorff, and $C^\infty(U)$ becomes a topological vector space.

Let us see that this topology is given by a countable subfamily of these seminorms and is therefore implemented by a metric. It is certainly sufficient to consider only the monomials D^α instead of all polynomials $P(D)$, and thus the P index of (K, P) can be assumed to run through a countable set. We make use of a notion already used in Section III.2. An **exhausting sequence** of compact subsets of U is an increasing sequence of compact sets with union U such that each set is contained in the interior of the next set. An exhausting sequence exists in any locally compact separable metric space. If $\{K_n\}$ is an exhausting sequence for U and if K is a compact subset of U , then the interiors K_n^o of the K_n 's form an open cover of K , and there is a finite subcover; since the members of the open cover are nested, K is contained in some single K_n^o and hence in K_n . Therefore $\|f\|_{K,P} \leq \|f\|_{K_n,P}$ for every P , and we can discard all the seminorms except the ones from some K_n . In short, the countably many seminorms $\|f\|_{K_n, x^\alpha} = \sup_{x \in K_n} |(D^\alpha f)(x)|$ suffice to determine the topology of $C^\infty(U)$. In particular, the topology is independent of the choice of exhausting sequence.

After the statement of Theorem 3.9, we constructed a smooth partition of unity $\{\psi_n\}_{n \geq 1}$ associated to an exhausting sequence $\{K_n\}_{n \geq 1}$ of an open subset U of \mathbb{R}^N . Such a partition of unity is sometimes useful, and Problem 9 at the end of the chapter illustrates this fact. The functions ψ_n are in $C^\infty(U)$ and have the properties that $\sum_{n=1}^{\infty} \psi_n(x) = 1$ on U , $\psi_1(x) > 0$ on K_3 , $\psi_1(x) = 0$ on $(K_4^o)^c$, and for $n \geq 2$,

$$\psi_n(x) \begin{cases} > 0 & \text{for } x \in K_{n+2} - K_{n+1}^o, \\ = 0 & \text{for } x \in (K_{n+3}^o)^c \cup K_n. \end{cases}$$

Since $C^\infty(U)$ is a metric space, its topology may be characterized in terms of convergence of sequences: a sequence of functions converges in $C^\infty(U)$ if and only if the functions converge uniformly on each compact subset of U and so do each of their iterated partial derivatives

If a particular metric for $C^\infty(U)$ is specified as constructed in Section III.1 from an enumeration of some determining countable family of seminorms, then it is apparent that a sequence of functions is Cauchy in $C^\infty(U)$ if and only if the functions and all their iterated partial derivatives are uniformly Cauchy on each compact subset of U . As a consequence we can see that $C^\infty(U)$ is complete as a metric space: in fact, let us extract limits from each uniformly Cauchy sequence of derivatives and use the standard theorem on derivatives of convergent sequences whose derivatives converge uniformly; the result is that we obtain a member of $C^\infty(U)$ to which the Cauchy sequence converges.

It is unimportant which particular metric is used for this completeness argument. The relevant consequence is that the Baire Category Theorem⁴ is applicable to $C^\infty(U)$, and the statement of the Baire Category Theorem makes no reference to a particular metric.

In similar fashion one checks that $\mathcal{S}(\mathbb{R}^N)$, whose topology is likewise given by countably many seminorms, is complete as a metric space.

The vector space of continuous linear functionals on $C^\infty(U)$, i.e., its **continuous dual**, is called the space of all **distributions of compact support** on U and is traditionally⁵ denoted by $\mathcal{E}'(U)$. The words “of compact support” require some explanation and justification, which we come back to after giving an example.

EXAMPLE. Take finitely many complex Borel measures ρ_α of compact support on U , the indexing being by the set of n -tuples α of nonnegative integers with $|\alpha| \leq m$, and define

$$T(\varphi) = \sum_{|\alpha| \leq m} \int_U D^\alpha \varphi(x) d\rho_\alpha(x).$$

It is easy to check that T is a distribution of compact support on U . A theorem in Chapter V will provide a converse, saying essentially that every continuous linear functional on $C^\infty(U)$ is of this form.

Let us observe that the vector subspace $C_{\text{com}}^\infty(U)$ is dense in $C^\infty(U)$. In fact, let $\{K_j\}$ be an exhausting sequence of compact sets in U , and choose $\psi_j \in C_{\text{com}}^\infty(\mathbb{R}^n)$ by Proposition 3.5f to be 1 on K_j and 0 off K_{j+1} . If f is in $C^\infty(U)$, then $\psi_j f$ is in $C_{\text{com}}^\infty(U)$ and tends to f in every seminorm on $C^\infty(U)$.

To obtain a useful notion of “support” for a distribution, we need the following lemma.

Lemma 4.9. If U_1 and U_2 are nonempty open sets in \mathbb{R}^N and if φ is in $C_{\text{com}}^\infty(U_1 \cup U_2)$, then there exist $\varphi_1 \in C_{\text{com}}^\infty(U_1)$ and $\varphi_2 \in C_{\text{com}}^\infty(U_2)$ such that $\varphi = \varphi_1 + \varphi_2$.

PROOF. Let L be the compact support of φ , and choose a compact set K such that $L \subseteq K^\circ \subseteq K \subseteq U_1 \cup U_2$. Then $\{U_1, U_2\}$ is a finite open cover of K , and Lemma 3.15b of *Basic* produces an open cover $\{V_1, V_2\}$ of K such that V_1^{cl} is a compact subset of U_1 and V_2^{cl} is a compact subset of U_2 . Proposition 3.5f produces functions $g_1 \in C_{\text{com}}^\infty(U_1)$ and $g_2 \in C_{\text{com}}^\infty(U_2)$ with values in $[0, 1]$ such that g_1 is 1 on V_1^{cl} and g_2 is 1 on V_2^{cl} . Then $g = g_1 + g_2$ is in $C_{\text{com}}^\infty(U_1 \cup U_2)$ and

⁴Theorem 2.53 of *Basic*.

⁵The tradition dates back to Laurent Schwartz’s work, in which $\mathcal{E}(U)$ was the notation for $C^\infty(U)$ and $\mathcal{E}'(U)$ was the space of continuous linear functionals.

is 1 on K . If W is the open set where $g \neq 0$, then Proposition 3.5f produces a function h in $C_{\text{com}}^\infty(W)$ with values in $[0, 1]$ such that h is 1 on K . The function $1 - h$ is smooth, has values in $[0, 1]$, is 1 where $g \neq 0$, and is 0 on K . Hence $g + (1 - h)$ is a smooth function that is everywhere positive on \mathbb{R}^N and equals g on K . Therefore the functions $g_1/(g + 1 - h)$ and $g_2/(g + 1 - h)$ are smooth functions on \mathbb{R}^N compactly supported in U_1 and U_2 , respectively, with sum equal to 1 on K . If we define $\varphi_1 = g_1\varphi$ and $\varphi_2 = g_2\varphi$, then φ_1 and φ_2 have the required properties. \square

Proposition 4.10. If T is an arbitrary linear functional on $C_{\text{com}}^\infty(U)$ and if U' is the union of all open subsets U_γ of U such that T vanishes on $C_{\text{com}}^\infty(U_\gamma)$, then T vanishes on $C_{\text{com}}^\infty(U')$.

PROOF. Let φ be in $C_{\text{com}}^\infty(U')$, and let K be the support of φ . The open sets U_γ form an open cover of K , and some finite subcollection must have $K \subseteq U_{\gamma_1} \cup \cdots \cup U_{\gamma_p}$. Lemma 4.9 applied inductively shows that φ is the sum of functions in $C_{\text{com}}^\infty(U_j)$, $1 \leq j \leq p$. Since T is 0 on each of these, it is 0 on the sum. \square

If T is in $\mathcal{E}'(U)$, the **support** of T is the complement of the set U' in Proposition 4.10, i.e., the complement of the union of all open sets U_γ such that T vanishes on $C_{\text{com}}^\infty(U_\gamma)$. If T has empty support, then $T = 0$ because T vanishes on $C_{\text{com}}^\infty(U)$ and $C_{\text{com}}^\infty(U)$ is dense in $C^\infty(U)$.

Proposition 4.11. Every member T of $\mathcal{E}'(U)$ has compact support.

REMARKS. For the moment this proposition justifies using the name “distributions of compact support” for the continuous linear functionals on $C^\infty(U)$. After we define general distributions in Section V.1, we shall have to return to this matter.

PROOF. Let $\{K_n\}$ be an exhausting sequence of compact sets in U . If T is not supported in any K_n , then there is some f_n in $C_{\text{com}}^\infty(U - K_n)$ with $T(f_n) \neq 0$. Put $g_n = f_n/T(f_n)$, so that $T(g_n) = 1$. If K is any compact subset of U , then $K \subseteq K_n$ for large n , and $g_n|_K = 0$ for such n . Thus g_n tends to 0 in $C^\infty(U)$ while $T(g_n)$ tends to $1 \neq 0 = T(0)$, in contradiction to continuity of T . \square

Similarly we can use Proposition 4.10 to define the **support** of a tempered distribution T in $\mathcal{S}'(\mathbb{R}^N)$ as the complement of the union of all open sets U_γ such that T vanishes on $C_{\text{com}}^\infty(U_\gamma)$. Tempered distributions need not have compact support; for example, the function 1 defines a tempered distribution whose support is \mathbb{R}^N .

In the case of tempered distributions, a little argument is required to show that the only tempered distribution with empty support is the 0 distribution. What is needed is the following fact.

Proposition 4.12. $C_{\text{com}}^{\infty}(\mathbb{R}^N)$ is dense in $\mathcal{S}(\mathbb{R}^N)$.

REMARKS. If T in $\mathcal{S}'(\mathbb{R}^N)$ has empty support, then T vanishes on $C_{\text{com}}^{\infty}(\mathbb{R}^N)$. Proposition 4.12 and the continuity of T imply that $T = 0$ on $\mathcal{S}(\mathbb{R}^N)$. Thus the only tempered distribution with empty support is the 0 distribution.

PROOF. Fix h in $C_{\text{com}}^{\infty}(\mathbb{R}^N)$ with values in $[0, 1]$ such that $h(x)$ is 1 for $|x| \leq 1$ and is 0 for $|x| \geq 2$. Define $h_R(x) = h(R^{-1}x)$. If φ is in $\mathcal{S}(\mathbb{R}^N)$, we shall show that $\lim_{R \rightarrow \infty} h_R \varphi = \varphi$ in the metric space $\mathcal{S}(\mathbb{R}^N)$, and then the proposition will follow. Thus we want $\lim_{R \rightarrow \infty} \sup_{x \in \mathbb{R}^N} |x^\gamma D^\alpha(\varphi - h_R \varphi)(x)| = 0$. By the Leibniz rule, $D^\alpha(h_R \varphi) = h_R D^\alpha \varphi + \sum_{\beta < \alpha} c_\beta (D^{\alpha-\beta} h_R)(D^\beta \varphi)$. Hence it is enough to prove that

$$\lim_{R \rightarrow \infty} \sup_{x \in \mathbb{R}^N} |x^\gamma (1 - h_R) D^\alpha \varphi| = 0$$

$$\text{and} \quad \lim_{R \rightarrow \infty} \sup_{x \in \mathbb{R}^N} |x^\gamma (D^{\alpha-\beta} h_R)(D^\beta \varphi)| = 0 \quad \text{for } \beta < \alpha.$$

The first of these limit formulas is a consequence of the fact that $x^\gamma D^\alpha \varphi$ vanishes at infinity, which in turn follows from the fact that $x^\gamma (1 + |x|^2) D^\alpha \varphi$ is bounded, i.e., that $\|\varphi\|_{x^\gamma(1+|x|^2), x^\alpha}$ is finite. For the second of these limit formulas, we observe from the chain rule that $D^{\alpha-\beta} h_R(x) = R^{-|\alpha-\beta|} D^{\alpha-\beta} h(R^{-1}x)$. For $\beta < \alpha$, this function is dominated in absolute value by $c_\alpha R^{-1}$. Hence $\sup_{x \in \mathbb{R}^N} |x^\gamma (D^{\alpha-\beta} h_R)(D^\beta \varphi)| \leq c_\alpha R^{-1} \sum_{\beta < \alpha} \|\varphi\|_{x^\gamma, x^\beta}$, and the limit on R is 0. \square

3. Weak and Weak-Star Topologies, Alaoglu's Theorem

Let X be a normed linear space, and let X^* be its dual, which we know to be a Banach space. We have defined the **weak topology** on X to be the weakest topology on X making all members of X^* continuous, i.e., making $x \mapsto x^*(x)$ continuous for each x^* in X^* . This topology is given by the family of seminorms $\|x\|_{x^*} = |x^*(x)|$ indexed by X^* . The **weak-star topology** on X^* relative to X is the weakest topology on X^* making all members of $\iota(X)$ continuous,⁶ i.e., making $x^* \mapsto x^*(x)$ continuous for each x in X . This topology is given by the family of seminorms $\|x^*\|_x = |x^*(x)|$ indexed by X . In this section we

⁶The symbol ι denotes the canonical map $X \rightarrow X^{**}$ given by $\iota(x)(x^*) = x^*(x)$.

study these topologies⁷ in more detail, proving an important theorem about the weak-star topology.

We shall discuss some examples in a moment. The space X^* is a normed linear space in its own right, and therefore it has a well-defined weak topology. The definitions make the weak topology on X^* the same as the weak-star topology on X^* relative to X if X is reflexive, but we cannot draw this conclusion in general.

The weak topology on X is of less importance to real analysis than the weak-star topology on X^* , and thus the main interest in the weak topology on X will be in the case that X is reflexive. It is also true that exact conditions that interpret the weak or weak-star topology in a particular example tend not to be useful. Nevertheless, it may still be helpful to consider examples in order to get a better sense of what these topologies do.

We shall discuss the examples in terms of convergence. However, the convergence will involve only convergence of sequences, not convergence of general nets. A difficulty with nets is that one cannot draw familiar conclusions from convergence of nets even in the case of nets in the real numbers; for example, a convergent net of real numbers need not be bounded, just eventually bounded.

In order to have it available in the discussion, we prove one fact about convergence of sequences in weak and weak-star topologies before coming to the examples.

Proposition 4.13. Let X be a normed linear space, and let X^* be its dual space.

(a) If $\{x_n\}$ is a sequence in X converging to x_0 in the weak topology on X , then $\{\|x_n\|\}$ is a bounded sequence in \mathbb{R} and $\|x_0\| \leq \liminf_n \|x_n\|$.

(b) If X is a Banach space and if $\{x_n^*\}$ is a sequence in X^* converging to x_0^* in the weak-star topology on X^* relative to X , then $\{\|x_n^*\|\}$ is a bounded sequence in \mathbb{R} and $\|x_0^*\| \leq \liminf_n \|x_n^*\|$.

PROOF. For the first half of (a), let $\iota : X \rightarrow X^{**}$ be the canonical map. Since the sequence $\{\iota(x_n)(x^*)\}$ converges to $x^*(x_0)$ for each x^* in X^* , $\{\iota(x_n)\}$ is a set of bounded linear functionals on the Banach space X^* with $\{\iota(x_n)(x^*)\}$ bounded for each x^* in X^* . By the Uniform Boundedness Theorem the norms $\|\iota(x_n)\|$ are bounded. Since ι preserves norms as a consequence of the Hahn–Banach Theorem, the norms $\|x_n\|$ are bounded. For the second half of (a), let x^* be arbitrary in X^* with $\|x^*\| \leq 1$. Then

$$|x^*(x_0)| = \lim |x^*(x_n)| \leq \liminf \|x^*\| \|x_n\| \leq \liminf \|x_n\|.$$

Taking the supremum over x^* with $\|x^*\| \leq 1$ and applying the formula $\|x_0\| = \sup_{\|x^*\| \leq 1} |x^*(x_0)|$, which is known from the Hahn–Banach Theorem, we obtain $\|x_0\| \leq \liminf \|x_n\|$.

⁷The weak topology on X is also called the X^* topology of X , and the weak-star topology on X^* is also called the X topology of X^* .

For the first half of (b), $\{x_n^*\}$ is a set of bounded linear functionals on the Banach space X with $\{x_n^*(x)\}$ bounded for each x in X . Then the Uniform Boundedness Theorem shows that the norms $\|x_n^*\|$ are bounded. For the second half of (b), let x be arbitrary in X with $\|x\| \leq 1$. Then

$$|x_0^*(x)| = \lim |x_n^*(x)| \leq \liminf \|x_n^*\| \|x\| \leq \liminf \|x_n^*\|.$$

Taking the supremum over x and applying the definition of $\|x_0^*\|$, we obtain $\|x_0^*\| \leq \liminf \|x_n^*\|$. \square

EXAMPLES OF CONVERGENCE IN WEAK TOPOLOGIES.

(1) $X = L^p(S, \mu)$ when $1 < p < \infty$. Then $X^* \cong L^{p'}(S, \mu)$, where p' is the dual index⁸ of p . The assertion is that a sequence $\{f_n\}$ tends weakly to f in L^p if and only if $\{\|f_n\|_p\}$ is bounded and $\lim \int_E f_n d\mu = \int_E f d\mu$ for every measurable subset E of S of finite measure. The necessity is immediate from Proposition 4.13a and from taking the member of X^* to be the indicator function of E . Let us prove the sufficiency. From $\lim \int_E f_n d\mu = \int_E f d\mu$, we see that $\lim \int_S f_n t d\mu = \int_S f t d\mu$ for t simple if t is 0 off a set of finite measure. Let g be given in $L^{p'}(S, \mu)$, and choose a sequence $\{t_m\}$ of simple functions equal to 0 off sets of finite measure such that $\lim_m t_m = g$ in the norm topology of $L^{p'}$. For all m and n , we have

$$\begin{aligned} & \left| \int_S f_n g d\mu - \int_S f g d\mu \right| \\ & \leq \left| \int_S f_n (g - t_m) d\mu \right| + \left| \int_S f_n t_m d\mu - \int_S f t_m d\mu \right| \\ & \quad + \left| \int_S f (t_m - g) d\mu \right| \\ & \leq \|f_n\|_p \|g - t_m\|_{p'} + \left| \int_S f_n t_m d\mu - \int_S f t_m d\mu \right| + \|f\|_p \|g - t_m\|_{p'}. \end{aligned}$$

The first and third terms on the right tend to 0 as m tends to infinity, uniformly in n . If $\epsilon > 0$ is given, choose m such that those two terms are $< \epsilon$, and then, with m fixed, choose n large enough to make the middle term $< \epsilon$.

(2) $X = C(S)$ with S compact Hausdorff, $C(S)$ being the space of continuous scalar-valued functions on S . Then X^* may be identified with the space $M(S)$ of (signed or) complex regular Borel measures on S , with the total-variation norm.⁹ The assertion is that a sequence $\{f_n\}$ tends weakly to f in $C(S)$ if and only if $\{\|f_n\|\}$ is bounded and $\lim f_n = f$ pointwise. The necessity is immediate from Proposition 4.13a and from taking the member of X^* to be any point mass at a point

⁸The index p' is defined by $\frac{1}{p} + \frac{1}{p'} = 1$. This duality was proved in Theorem 9.19 of *Basic* when μ is σ -finite, but it holds without this restrictive assumption on μ .

⁹This identification was obtained in *Basic* in Theorem 11.24 for real scalars and in Theorem 11.26 for complex scalars. The starting point for the identification is the Riesz Representation Theorem.

of S . For the sufficiency we simply observe that any member of $M(S)$ is a finite linear combination of regular Borel measures μ on S and $\lim \int_S f_n d\mu = \int_S f d\mu$ for any Borel measure μ by dominated convergence.

(3) $X = C_0(S)$ with S locally compact separable metric, $C_0(S)$ being the space of continuous scalar-valued functions vanishing at infinity. Again the dual X^* may be identified with the space $M(S)$ of complex regular Borel measures on S , with the total-variation norm. This example can be handled by applying the previous example to the one-point compactification of S . All signed or complex Borel measures are automatically regular in this case. A sequence $\{f_n\}$ tends weakly to f in $C_0(S)$ if and only if $\{\|f_n\|\}$ is bounded and $\lim f_n = f$ pointwise.

EXAMPLES OF CONVERGENCE IN WEAK-STAR TOPOLOGIES.

(1) $X = L^p(S, \mu)$ and $X^* \cong L^{p'}(S, \mu)$ when $1 < p < \infty$, p' being the dual index of p . This X is reflexive. Therefore the first example of convergence in weak topologies shows that $\{f_n\}$ converges weak-star in $L^{p'}(S, \mu)$ relative to $L^p(S, \mu)$ if and only if $\{\|f_n\|_{p'}\}$ is bounded and $\lim \int_E f_n d\mu = \int_E f d\mu$ for every measurable subset E of S of finite measure.

(2) $X = L^1(S, \mu)$ and $X^* \cong L^\infty(S, \mu)$ when μ is σ -finite. This X is usually not reflexive. However, the condition for weak-star convergence is the same as in the previous example: $\{f_n\}$ converges weak-star in $L^\infty(S, \mu)$ relative to $L^1(S, \mu)$ if and only if $\{\|f_n\|_\infty\}$ is bounded and $\lim \int_E f_n d\mu = \int_E f d\mu$ for every measurable subset E of S of finite measure. The argument in the first example of convergence in weak topologies can easily be modified to prove this.

(3) $X = C(S)$ with S compact Hausdorff, and $X = C_0(S)$ with S locally compact separable metric. Weak-star convergence of complex regular Borel measures does not have a useful necessary and sufficient condition beyond the definition. The notion of weak-star convergence in this situation is, nevertheless, quite helpful as a device for producing new complex measures out of old ones.¹⁰

A theorem about the weak topology, due to Banach, is that the vector subspaces that are closed in the weak topology are the same as the vector subspaces that are closed in the norm topology. More generally the closed convex sets coincide in the weak and norm topologies. We shall not have occasion to use this theorem or mention any of its applications, and we therefore omit the proof.

The weak-star topology has results of more immediate interest, and we turn our attention to those. Theorem 5.58 of *Basic* established for any separable normed linear space X that any bounded sequence in the dual X^* has a weak-star convergent subsequence; this was called a "preliminary form of Alaoglu's Theorem."

¹⁰*Warning.* Many probabilists and some other people use the unfortunate term "weak convergence" for this instance of weak-star convergence.

Theorem 4.14 Let X be a normed linear space with dual X^* .

(a) (**Alaoglu's Theorem**) The closed unit ball of X^* is compact in the weak-star topology relative to X .

(b) If X is separable, then the closed unit ball of X^* is a separable metric space in the weak-star topology.

REMARKS. By (a), any net $\{x_\alpha^*\}$ in X^* with $\|x_\alpha^*\|$ bounded has a subnet $\{x_{\alpha_\mu}^*\}$ and an element x_0^* in X^* such that $x_{\alpha_\mu}^*(x) \rightarrow x_0^*(x)$ for every x in X . By (b), this conclusion about nets can be replaced by a conclusion about sequences if X is separable. Thus we recover the “preliminary form” of Alaoglu's Theorem. The results of Section III.4 give an example of the utility of the two parts of this theorem; together they lead to a proof that harmonic functions in $\mathcal{H}^p(\mathbb{R}_+^{N+1})$ are automatically Poisson integrals of functions if $p > 1$ or of complex measures if $p = 1$.

PROOF. Let B be the closed unit ball in X^* , let $D(r)$ be the closed disk in \mathbb{C} with radius r and center 0, and let $C = \prod_{x \in X} D(\|x\|)$. Define $F : B \rightarrow C$ by $F(x^*) = \prod_{x \in X} x^*(x)$. The function F is well defined since $|x^*(x)| \leq \|x\|$ for all x^* in B and all x in X . It is continuous as a map into the product space since $x^* \mapsto x^*(x)$ is continuous for each x , it is one-one since x^* is determined by its values on each x , and it is a homeomorphism with its image by definition of weak topology. Since C is compact by the Tychonoff Product Theorem, (a) will follow if it is shown that $F(B)$ is closed in C . Let p_x denote the projection of C to its x^{th} coordinate. If x and x' are in X and if $\{f_\alpha\}$ is a net in C convergent to f_0 in C , then an equality $p_{x+x'}(f_\alpha) = p_x(f_\alpha) + p_{x'}(f_\alpha)$ for all α implies that $p_{x+x'}(f_0) = p_x(f_0) + p_{x'}(f_0)$ by continuity of $p_{x+x'}$, p_x , and $p_{x'}$. Thus the set

$$S(x, x') = \{f \in C \mid p_{x+x'}(f) = p_x(f) + p_{x'}(f)\}$$

is closed, and similarly the set

$$T(x, c) = \{f \in C \mid cp_x(f) = p_x(cf)\}$$

is closed. The intersection of all $S(x, x')$'s and all $T(x, c)$'s is the set of linear members of C , hence is exactly $F(B)$. Thus $F(B)$ is closed.

For (b), we continue with B and $D(r)$ as above, but we change C and F slightly. Let $\{x_n\}$ be a countable dense set in the norm topology of X , let $C = \prod_{x_n} D(\|x_n\|)$, and define $F : B \rightarrow C$ by $F(x^*) = \prod_{x_n} x^*(x_n)$. As in the proof of (a), F is continuous. It is one-one since any x^* , being continuous, is determined by its values on the dense set $\{x_n\}$. The domain is compact by (a). The range space C is a separable metric space and is in particular Hausdorff. Hence B is exhibited as homeomorphic to $F(B)$, which is a subspace of the separable metric space C and is therefore separable. \square

4. Stone Representation Theorem

In this section we begin to follow Alaoglu's Theorem along paths different from its use for creating limit functions and measures out of sequences that are bounded in a weak-star topology. We shall work in this section with what amounts to an example—one of the motivating examples behind a stunning idea of I. M. Gelfand around 1940 that brings algebra, real analysis, and complex analysis together in a profound way. The example gives a view of subalgebras of the algebra $B(S)$ of all bounded functions on a set S in terms of compactness. The stunning idea that came out, on which we shall elaborate shortly, is that the mechanism in the proof is the same mechanism that lies behind the Fourier transform on \mathbb{R}^N , that this mechanism can be cast in abstract form as a theory of commutative Banach algebras, and that the theory gives a new perspective about spectra. In particular, it leads directly to the full Spectral Theorem for bounded and unbounded self-adjoint operators, extending the theorem for compact self-adjoint operators that was proved as Theorem 2.3. In turn, the Spectral Theorem has many applications to the study of particular operators.

Let us first state the theorem about $B(S)$, then discuss Gelfand's stunning idea about the mechanism, and finally give the proof of the theorem. We shall pursue the Gelfand idea in Sections 10–11 later in this chapter.

We have discussed $B(S)$ as the Banach space of bounded complex-valued functions on a nonempty set S , the norm being the supremum norm. In this Banach space pointwise multiplication makes $B(S)$ into a complex associative algebra¹¹ with identity (namely the function 1), there is an operation of complex conjugation, and there is a notion of positivity (namely pointwise positivity of a function). The theorem concerns subalgebras of $B(S)$ containing 1, closed under conjugation, and closed under uniform limits.

Theorem 4.15 (Stone Representation Theorem). Let S be a nonempty set, and let \mathcal{A} be a uniformly closed subalgebra of $B(S)$ with the properties that \mathcal{A} is stable under complex conjugation and contains 1. Then there exist a compact Hausdorff space S_1 , a function $p : S \rightarrow S_1$ with dense image, and a norm-preserving algebra isomorphism U of \mathcal{A} onto $C(S_1)$ preserving conjugation and positivity, mapping 1 to 1, and having the property that $U(f)(p(s)) = f(s)$ for all s in S . If S is a Hausdorff topological space and \mathcal{A} consists of continuous functions, then p is continuous.

¹¹An **associative algebra** \mathcal{A} over \mathbb{C} is a vector space with a \mathbb{C} bilinear associative multiplication, i.e., with an operation $\mathcal{A} \times \mathcal{A} \rightarrow \mathcal{A}$ satisfying $(ab)c = a(bc)$, $a(b+c) = ab+ac$, $(a+b)c = ac+bc$, and $a(\lambda c) = (\lambda a)c = \lambda(ac)$ if λ is in \mathbb{C} and a, b, c are in \mathcal{A} . This definition does not assume the existence of an identity element.

The idea of the proof is to consider the Banach-space dual \mathcal{A}^* and focus on those members of \mathcal{A}^* that are nonzero and respect multiplication—the nonzero continuous multiplicative linear functionals on \mathcal{A} . The ones that come immediately to mind are the evaluations at each point: for a point s of S , the evaluation at s is given by $e_s(f) = f(s)$, and it is a multiplicative linear functional, certainly of norm 1. The set S_1 in the theorem will be the set of all such continuous multiplicative linear functionals, the function p will be given by $p(s) = e_s$ for $s \in S$, and the mapping U will be given by $U(f)(\ell) = \ell(f)$ for each multiplicative linear functional ℓ .

The Banach space $\mathcal{A} \subseteq B(S)$, with its multiplication, is a **Banach algebra** in the sense that it is an associative algebra over \mathbb{C} , with or without identity, such that $\|fg\| \leq \|f\|\|g\|$ for all f and g in \mathcal{A} . Another well-known Banach algebra is $L^1(\mathbb{R}^N)$. The norm in this case is the usual L^1 norm, and the multiplication is convolution, which satisfies $\|f * g\|_1 \leq \|f\|_1\|g\|_1$ for all f and g in $L^1(\mathbb{R}^N)$.

The stunning idea of Gelfand's is that the formula that defines U in the Stone theorem is the same formula that gives the Fourier transform in the case of $L^1(\mathbb{R}^N)$. Specifically the nonzero multiplicative linear functionals in the case of $L^1(\mathbb{R}^N)$ are the evaluations at points of the Fourier transform, i.e., the mappings $f \mapsto \widehat{f}(y) = \int_{\mathbb{R}^N} f(x)e^{-2\pi i x \cdot y} dx$. These linear functionals are multiplicative because convolution goes into pointwise product under the Fourier transform.

What $\mathcal{A} \subseteq B(S)$ and $L^1(\mathbb{R}^N)$ have in common is, in the first place, that they are commutative Banach algebras. In addition, each has a conjugate-linear mapping $f \mapsto f^*$ that respects multiplication: complex conjugation in the case of \mathcal{A} and the map $f \mapsto f^*$ with $f^*(x) = \overline{f(-x)}$ in the case of $L^1(\mathbb{R}^N)$. These conjugate-linear mappings interact well with the norm. The subalgebra \mathcal{A} of $B(S)$ satisfies

- (i) $\|ff^*\| = \|f\|\|f^*\|$ for all f ,
- (ii) $\|f^*\| = \|f\|$ for all f ,

while $L^1(\mathbb{R}^N)$ satisfies just (ii). The theory that Gelfand developed applies best when both (i) and (ii) are satisfied, as is the case with \mathcal{A} and also any L^∞ space, and it works somewhat when just (ii) holds, as with $L^1(\mathbb{R}^N)$.

Another example of a Banach algebra is the algebra $\mathcal{B}(H, H)$ of bounded linear operators from a Hilbert space H to itself, with the operator norm. The conjugate-linear mapping on $\mathcal{B}(H, H)$ is passage to the adjoint, and (i) and (ii) both hold. The thing that is missing is commutativity for $\mathcal{B}(H, H)$. However, if we take a single operator A and its adjoint A^* , assume that A commutes with A^* , and take the Banach algebra generated by A and A^* , then we have another example to which the Gelfand theory applies well. The Spectral Theorem for bounded self-adjoint operators is the eventual consequence.

The idea of considering the Banach subalgebra generated by A is a natural one because of one's experience in the subject of modern algebra: the study of

all complex polynomials in a square matrix A is a useful tool in understanding a single linear transformation, including obtaining canonical forms for it like the Jordan form. Thus the use of an analogy with a topic in algebra leads one to a better understanding of a topic in analysis.

In this case ideas flowed in the reverse direction as well. The multiplicative linear functionals correspond, by passage to their kernels, to those ideals in the algebra that are maximal.¹² In effect the Banach algebra was being studied through its space of maximal ideals. About 1960, no doubt partly because of the success of the idea of considering the maximal ideals of a Banach algebra, the consideration of the totality of prime ideals of a commutative ring as a space began to play an important role in algebraic number theory and algebraic geometry.

PROOF OF THEOREM 4.15. Let S_1 be the set of all nonzero continuous multiplicative linear functionals ℓ on \mathcal{A} with $\ell(\bar{f}) = \overline{\ell(f)}$. Let us see that each such has norm 1. In fact, choose f with $\ell(f) \neq 0$. Then $\ell(f) = \ell(f1) = \ell(f)\ell(1)$ shows that $\ell(1) = 1$, and hence $\|\ell\| \geq 1$. For any f with $\|f\|_{\text{sup}} \leq 1$, if we had $|\ell(f)| > 1$, then $|\ell(f)|^n = |\ell(f^n)| \leq \|\ell\|$ for all n would give a contradiction as soon as n is sufficiently large. We conclude that $\|\ell\| \leq 1$.

Therefore S_1 is a subset of the unit ball of the Banach-space dual \mathcal{A}^* . We give S_1 the relative topology from the weak-star topology on \mathcal{A}^* . Let us define the function $p : S \rightarrow S_1$, and in the process we shall have proved that S_1 is not empty. Every s in S defines an evaluation linear functional e_s in S_1 by $e_s(f) = f(s)$, and the function p is defined by $p(s) = e_s$ for s in S . To see that S_1 is a closed subset of the unit ball of \mathcal{A}^* in the weak-star topology, let $\{\ell_\alpha\}$ be a net in S_1 converging to some $\ell \in \mathcal{A}^*$, the convergence being in the weak-star topology. Then we have $\ell_\alpha(fg) = \ell_\alpha(f)\ell_\alpha(g)$ and $\ell_\alpha(\bar{f}) = \overline{\ell_\alpha(f)}$ for all f and g in \mathcal{A} . Passing to the limit, we obtain $\ell(fg) = \ell(f)\ell(g)$ and $\ell(\bar{f}) = \overline{\ell(f)}$. Hence S_1 is closed. By Alaoglu's Theorem (Theorem 4.14a), S_1 is compact. It is Hausdorff since \mathcal{A}^* is Hausdorff in the weak-star topology.

Certainly we have $\sup_{s \in S} |e_s(f)| = \|f\|_{\text{sup}}$. Since any ℓ in S_1 has $\|\ell\| \leq 1$, we obtain

$$\sup_{\ell \in S_1} |\ell(f)| = \|f\|_{\text{sup}}. \quad (*)$$

The definition of $U : \mathcal{A} \rightarrow C(S_1)$ is $U(f)(\ell) = \ell(f)$, and this makes $U(f)(p(s)) = U(f)(e_s) = e_s(f) = f(s)$. The function $U(f)$ on S_1 is continuous by definition of the weak-star topology. Because of the definition of S_1 , U is an algebra homomorphism respecting complex conjugation and mapping 1 to 1.

¹²Checking that there are no other maximal ideals than the kernels of multiplicative linear functionals requires proving that every complex "Banach field" is 1-dimensional, an early result in the subject of Banach algebras and one that uses complex analysis in its proof. Details appear in Section 10.

Also, (*) shows that U is an isometry. Since \mathcal{A} is Cauchy complete, so is $U(\mathcal{A})$. Therefore $U(\mathcal{A})$ is a uniformly closed subalgebra of $C(S_1)$ stable under complex conjugation and containing the constants. It separates points of S_1 by the definition of equality of linear functionals. By the Stone–Weierstrass Theorem, $U(\mathcal{A}) = C(S_1)$. Since U is an isometry, U is one-one. Thus U is an algebra isomorphism of \mathcal{A} onto $C(S_1)$.

If $p(S)$ were not dense in S_1 , then Urysohn’s Lemma would allow us to find a nonzero continuous function F on $C(S_1)$ with values in $[0, 1]$ such that F is 0 everywhere on $p(S)$. Since U is onto $C(S_1)$, choose $f \in \mathcal{A}$ with $U(f) = F$. If s is in S , then $0 = F(p(s)) = U(f)(p(s)) = f(s)$. Hence $\|f\|_{\text{sup}} = 0$. By (*), $\ell(f) = 0$ for all $\ell \in S_1$. Then every $\ell \in S_1$ has $0 = \ell(f) = U(f)(\ell) = F(\ell)$, and $F = 0$, contradiction. We conclude that $p(S)$ is dense.

To see that U carries functions ≥ 0 to functions ≥ 0 , we observe first that the identity $\ell(\bar{f}) = \overline{\ell(f)}$ for $\ell \in S_1$ and the equality $\bar{\bar{f}} = f$ for f real together imply that $\ell(f) = \overline{\ell(\bar{f})} = \overline{\overline{\ell(f)}}$ for f real. Hence f real implies $\ell(f)$ real. If $f \geq 0$, then $\|\|f\|_{\text{sup}} - f\|_{\text{sup}} \leq \|f\|_{\text{sup}}$. Since $\|\ell\| \leq 1$, we therefore have $\ell(\|f\|_{\text{sup}} - f) \leq \|\|f\|_{\text{sup}} - f\|_{\text{sup}} \leq \|f\|_{\text{sup}}$. Since $\ell(1) = 1$, this says that $\ell(f) \geq 0$. This inequality for all ℓ implies that $U(f) \geq 0$.

Finally suppose that S is a Hausdorff topological space and that $\mathcal{A} \subseteq C(S)$. We are to show that $p : S \rightarrow S_1$ is continuous. If $s_\alpha \rightarrow s_0$ for a net in S , we want $p(s_\alpha) \rightarrow p(s_0)$, i.e., $e_{s_\alpha} \rightarrow e_{s_0}$. According to the definition of the weak-star topology, we are thus to show that $f(s_\alpha) \rightarrow f(s_0)$ for every f in \mathcal{A} . But this is immediate from the continuity of f on S . \square

We give three examples. A fourth example, concerning “almost periodic functions,” will be considered in the problems at the end of Chapter VI. For this fourth example the compact Hausdorff space of Theorem 4.15 admits the structure of a compact group, and the representation theory of Chapter VI is applicable to describe the structure of the space of almost periodic functions.

Problems 21–25 at the end of the chapter develop the theory of Theorem 4.15 further.

EXAMPLES.

(1) $\mathcal{A} = C(S)$ with S compact Hausdorff. Then p is a homeomorphism of S onto S_1 . In fact, $p(S)$ is always dense in S_1 . Here p is continuous and S is compact. Thus $p(S)$ is closed and must equal S_1 . The map p is one-one because Urysohn’s Lemma produces functions taking different values at two distinct points s and s' of S and thus exhibiting $e_{s'}$ and e_s as distinct linear functionals. Since p is continuous and one-one from a compact space onto a Hausdorff space, it is a homeomorphism.

(2) One-point compactification. Let S be a locally compact Hausdorff space, and let \mathcal{A} be the subalgebra of $C(S)$ consisting of all continuous functions having

limits at infinity. For a function f , this condition means that there is some number c such that for each $\epsilon > 0$, some compact subset K of S has the property that $|f(s) - c| \leq \epsilon$ for all s not in K . Then S_1 may be identified with the one-point compactification of S .

(3) Stone–Čech compactification. Let S be a topological space, and let $\mathcal{A} = C(S)$. The resulting compact Hausdorff space S_1 is called the **Stone–Čech compactification** of S . This space tends to be huge. For example, if $S = [0, +\infty)$, the corresponding S_1 has cardinality greater than the cardinality of \mathbb{R} .

5. Linear Functionals and Convex Sets

For this section and the next we discuss aspects of functional analysis that lead toward the theory of distributions and toward the use of fixed-point theorems. The topic is the role of convex sets in real and complex vector spaces—first without any topology and then with an overlay of topology consistent with convex sets. Sections 7–9 will then explore the consequences of this development, first in connection with smooth functions and then in connection with fixed-point theorems.

Let X be a real or complex vector space. A subset E of X is **convex** if for each x and y in E , all points $(1 - t)x + ty$ are in E for $0 \leq t \leq 1$.

Proposition 4.16. Convex sets in a real or complex vector space have the following elementary properties:

- (a) the arbitrary intersection of convex sets is convex,
- (b) if E is convex and x_1, \dots, x_n are in E and t_1, \dots, t_n are nonnegative reals with $t_1 + \dots + t_n = 1$, then $t_1x_1 + \dots + t_nx_n$ is in E ,
- (c) if E_1 and E_2 are convex, then so are $E_1 + E_2$, $E_1 - E_2$, and cE for any scalar c ,
- (d) if $L : X \rightarrow Y$ is linear between two vector spaces with the same scalars and if E is a convex subset of X , then $L(E)$ is convex in Y ,
- (e) if $L : X \rightarrow Y$ is linear between two vector spaces with the same scalars and if E is a convex subset of Y , then $L^{-1}(E)$ is convex in X .

PROOF. Conclusions (a), (c), (d), and (e) are completely straightforward. For (b), we induct on n , the case $n = 2$ being the definition of “convex.” Suppose that the result is known for n and that members x_1, \dots, x_{n+1} of X and nonnegative reals t_1, \dots, t_{n+1} with sum 1 are given. We may assume that $t_1 \neq 1$. Put $s = t_2 + \dots + t_{n+1}$ and $y = (1 - t_1)^{-1}(t_2x_2 + \dots + t_{n+1}x_{n+1})$. Since the reals $(1 - t_1)^{-1}t_2, \dots, (1 - t_1)^{-1}t_{n+1}$ are nonnegative and have sum 1, the inductive hypothesis shows that y is in E . Since t_1 and s are nonnegative and have sum 1, $t_1x_1 + sy = t_1x_1 + \dots + t_{n+1}x_{n+1}$ is in E . This completes the induction. \square

Let E be a subset of our vector space X . We say that a point p in E is an **internal point** of E if for each x in X , there is an $\epsilon > 0$ such that $p + \delta x$ is in E for all scalars¹³ δ with $|\delta| \leq \epsilon$. If p in X is neither an internal point of E nor an internal point of E^c , we say that p is a **bounding point** of E . These notions make no use of any topology on X .

Let K be a convex subset of X , and suppose that 0 is an internal point of K . For each x in X , let

$$\rho(x) = \inf\{a > 0 \mid a^{-1}x \in K\}.$$

The function $\rho(x)$ is called the **support function** of K . For an example let X be a normed linear space, and let K be the unit ball; then $\rho(x) = \|x\|$.

We are going to see that $\rho(x)$ has some bearing on controlling the linear functionals on X , as a consequence of the Hahn–Banach Theorem. By the “Hahn–Banach Theorem” here, we mean not the usual theorem for normed linear spaces¹⁴ but the more primitive statement¹⁵ from which that is derived:

HAHN–BANACH THEOREM. Let X be a *real* vector space, and let p be a real-valued function on X with

$$p(x + x') \leq p(x) + p(x') \quad \text{and} \quad p(tx) = tp(x)$$

for all x and x' in X and all real $t \geq 0$. If f is a linear functional on a vector subspace Y of X with $f(y) \leq p(y)$ for all y in Y , then there exists a linear functional F on X with $F(y) = f(y)$ for all $y \in Y$ and $F(x) \leq p(x)$ for all $x \in X$.

Before discussing linear functionals in our present context, let us observe some properties of the support function $\rho(x)$. Properties (b), (c), and (e) in the next lemma are the properties of the dominating function p in the Hahn–Banach Theorem as stated above.

Lemma 4.17. Let K be a convex subset of a vector space X , and suppose that 0 is an internal point. Then the support function $\rho(x)$ of K satisfies

- (a) $\rho(x) \geq 0$,
- (b) $\rho(x) < \infty$,
- (c) $\rho(ax) = a\rho(x)$ for $a \geq 0$,
- (d) $\rho(x) \leq 1$ for all x in K ,
- (e) $\rho(x + y) \leq \rho(x) + \rho(y)$,
- (f) $\rho(x) < 1$ if and only if x is an internal point of K ,
- (g) $\rho(x) = 1$ characterizes the bounding points of K .

¹³The scalars are complex numbers if X is complex, real numbers if X is real.

¹⁴As in Theorem 12.13 of *Basic*.

¹⁵As in Lemma 12.14 of *Basic*.

PROOF. Conclusions (a), (c), and (d) are immediate, and (b) follows since 0 is an internal point of K .

For (e), let c be arbitrary with $c > \rho(x) + \rho(y)$. We show that $c^{-1}(x + y)$ is in K . Since c is arbitrary, it follows that the infimum of all numbers d with $d^{-1}(x + y)$ in K is $\leq \rho(x) + \rho(y)$; consequently $\rho(x + y)$ will have to be $\leq \rho(x) + \rho(y)$, and (e) will be proved. Thus write $c = a + b$ with $a > \rho(x)$ and $b > \rho(y)$. Since K is convex,

$$c^{-1}(x + y) = (a + b)^{-1}(x + y) = \frac{a}{a+b} a^{-1}x + \frac{b}{a+b} b^{-1}y$$

is in K , as required.

For (f), let x be an internal point of K . Then $x + \epsilon x = (1 + \epsilon)x$ is in K for some $\epsilon > 0$, and hence $\rho(x) \leq (1 + \epsilon)^{-1} < 1$.

Conversely suppose that $\rho(x) < 1$, and put $\epsilon = 1 - \rho(x)$. Fix y . Since 0 is an internal point of K , we can find $\mu > 0$ such that δy is in K for $|\delta| \leq \mu$. If c is any scalar of absolute value 1, then $c\mu y$ is in K , and hence $\rho(cy) \leq \mu^{-1}$. If δ is a scalar with $|\delta| < \epsilon\mu$, write $\delta = c'|\delta|$ with $|c'| = 1$. Then $\rho(\delta y) = |\delta|\rho(c'y) \leq |\delta|\mu^{-1} < \epsilon$. Applying (e) gives

$$\rho(x + \delta y) \leq \rho(x) + \rho(\delta y) = (1 - \epsilon) + \rho(\delta y) < (1 - \epsilon) + \epsilon = 1.$$

By definition of ρ , $1^{-1}(x + \delta y)$ is in K , i.e., $x + \delta y$ is in K . Thus x is an internal point of K .

For (g), we can argue in the same way as with (f) to see that $\rho(x) > 1$ characterizes the internal points of K^c . Therefore $\rho(x) = 1$ characterizes the bounding points of K . \square

We shall now apply the Hahn–Banach Theorem to prove the basic separation theorem.

Theorem 4.18. Let M and N be disjoint nonempty convex subsets of a real or complex vector space X , and suppose that M has an internal point. Then there exists a nonzero linear functional F on X such that for some real c , $\operatorname{Re} F \leq c$ on M and $\operatorname{Re} F \geq c$ on N .

PROOF. First suppose that X is real. If m is an internal point of M , then 0 is an internal point of $M - m$, and we can replace M and N by $M - m$ and $N - m$. Changing notation, we may assume from the outset that 0 is an internal point of M .

If x_0 is in N , then $-x_0$ is an internal point of $M - N$, and 0 is an internal point of $K = M - N + x_0$. Since M and N are assumed disjoint, $M - N$ does not contain 0; thus K does not contain x_0 . Let ρ be the support function

of K ; this function satisfies the properties of the function p in the Hahn–Banach Theorem, according to Lemma 4.17. Moreover, $\rho(x_0) \geq 1$ by Lemma 4.17f. Define $f(ax_0) = a\rho(x_0)$ for all (real) scalars a . Then f is a nonzero linear functional on the 1-dimensional space of real multiples of x_0 , and it satisfies

$$\begin{aligned} a \geq 0 & \quad \text{implies} & \quad f(ax_0) = a\rho(x_0) = \rho(ax_0), \\ a < 0 & \quad \text{implies} & \quad f(ax_0) = af(x_0) < 0 \leq \rho(ax_0). \end{aligned}$$

The Hahn–Banach Theorem shows that f extends to a linear functional F on X with $F(x) \leq \rho(x)$ for all x . Then $F(x_0) \geq 1$, and Lemma 4.17 shows that $\rho(K) \leq 1$. Hence

$$F(x_0) \geq 1 \quad \text{and} \quad F(M - N + x_0) \leq 1.$$

Thus we have $F(M - N + x_0) \leq F(x_0)$, $F(M - N) \leq 0$, $F(m - n) \leq 0$ for all m in M and n in N , and $F(m) \leq F(n)$ for all m and n . Taking the supremum over m in M and the infimum over n in N gives the conclusion of the theorem for X real.

Now suppose that the vector space X is complex. We can initially regard X as a real vector space by forgetting about complex scalars, and then the previous case allows us to construct a real-linear F such that $F(M) \leq c \leq F(N)$. Put $G(x) = F(x) - iF(ix)$. Since $G(ix) = F(ix) - iF(i^2x) = F(ix) - iF(-x) = F(ix) + iF(x) = i(F(x) - iF(ix)) = iG(x)$, G is complex linear. The real part of G equals F , and therefore G satisfies the conclusion of the theorem. \square

6. Locally Convex Spaces

In this section we shall apply the discussion of convex sets and linear functionals in the context of topological vector spaces. A topological vector space X is said to be **locally convex** if there is a base for its topology that consists of convex sets.

Let us see that any topological vector space X whose topology is given by a family of seminorms $\|\cdot\|_s$ is locally convex. A base for the open sets consists of all finite intersections of sets $U(y, s, r) = \{x \mid \|x - y\|_s < r\}$ with y in X , s equal to one of the seminorm indices, and $r > 0$. If x and x' are in $U(y, s, r)$ and if $0 \leq t \leq 1$, then

$$\begin{aligned} \|((1-t)x + tx') - y\|_s &= \|(1-t)(x - y) + t(x' - y)\|_s \\ &\leq \|(1-t)(x - y)\|_s + \|t(x' - y)\|_s \\ &= (1-t)\|x - y\|_s + t\|x' - y\|_s \\ &< (1-t)r + tr = r. \end{aligned}$$

Hence $((1-t)x + tx')$ is in $U(y, s, r)$, and $U(y, s, r)$ is convex. Since the arbitrary intersection of convex sets is convex by Proposition 4.16a, every member of the base for the topology is convex. Thus X is locally convex.

We are going to show that every locally convex topological vector space has many continuous linear functionals, enough to distinguish any two disjoint closed convex sets when one of them is compact. This result will in particular be applicable to the spaces $\mathcal{S}(\mathbb{R}^N)$ and $C^\infty(U)$ since their topologies are given by seminorms.

We begin with two lemmas that do not need an assumption of local convexity on the topological vector space.

Lemma 4.19. In any topological vector space if K_1 and K_2 are closed sets with K_1 compact, then the set $K_1 - K_2$ of differences is closed.

PROOF. It is simplest to use nets. Thus let x be a limit point of $K_1 - K_2$, and let $\{x_n\}$ be any net in $K_1 - K_2$ converging to x . Since each x_n is in $K_1 - K_2$, we can write it as $x_n = k_n^{(1)} - k_n^{(2)}$ with $k_n^{(1)}$ in K_1 and $k_n^{(2)}$ in K_2 . Since K_1 is compact, $\{k_n^{(1)}\}$ has a convergent subnet, say $\{k_{n_j}^{(1)}\}$. Let $k^{(1)}$ be the limit of $\{k_{n_j}^{(1)}\}$ in K_1 . Both $\{x_{n_j}\}$ and $\{k_{n_j}^{(1)}\}$ are convergent, and $\{k_{n_j}^{(2)}\}$ must be convergent because $k_{n_j}^{(2)} = k_{n_j}^{(1)} - x_{n_j}$ and subtraction is continuous. Let k_2 be its limit. This limit has to be in K_2 since K_2 is closed, and then the equation $x = k^{(1)} - k^{(2)}$ exhibits x as in $K_1 - K_2$. Hence $K_1 - K_2$ is closed. \square

Lemma 4.20. Let X be any topological vector space, let K_1 and K_2 be disjoint convex sets, and suppose that K_1 has nonempty interior. Then there exists a nonzero continuous linear functional F on X with $\operatorname{Re} F(K_1) \leq c$ and $c \leq \operatorname{Re} F(K_2)$ for some real number c .

PROOF. The key observation is that any interior point of a subset E of X is internal. In fact, if p is in E° and x is in X , then $p + \delta x$ is in E° for $\delta = 0$. By continuity of the vector-space operations and openness of E° , $p + \delta x$ is in E° for $|\delta|$ sufficiently small. Therefore p is an internal point.

Since K_1 consequently has an internal point, Theorem 4.18 produces a nonzero linear functional F such that

$$\operatorname{Re} F(K_1) \leq c \quad \text{and} \quad c \leq \operatorname{Re} F(K_2) \quad (*)$$

for some real number c . We complete the proof of the lemma by showing that F is continuous. Let f and g be the real and imaginary parts of F . Then $g(x) = -if(ix)$, and it is enough to show that f is continuous. Fix an interior point p of K_1 , and choose an open neighborhood U of 0 such that $p + U \subseteq K_1$. Then

$f(U) \subseteq f(K_1) - f(p)$ since f is real linear, and (*) shows that $f(U) \leq c - f(p)$. So $f(U) \leq a$ for some $a > 0$. If $V = U \cap (-U)$, then

$$f(V) = f(U \cap (-U)) \subseteq f(U) \cap f(-U) = f(U) \cap (-f(U)) \subseteq [-a, a],$$

and therefore $f(\epsilon a^{-1}V) \subseteq [-\epsilon, \epsilon]$. In other words, f is continuous at 0. Then $f(x + \epsilon a^{-1}V) \subseteq f(x) + [-\epsilon, \epsilon]$, and f is continuous everywhere. \square

Theorem 4.21. Let X be a locally convex topological vector space, let K_1 and K_2 be disjoint closed convex subsets of X , and suppose that K_1 is compact. Then there exist $\epsilon > 0$, a real constant c , and a continuous linear functional F on X such that

$$\operatorname{Re} F(K_2) \leq c - \epsilon \quad \text{and} \quad c \leq \operatorname{Re} F(K_1).$$

PROOF. Lemma 4.19 shows that $K_1 - K_2$ is closed, and $K_1 - K_2$ does not contain 0 because K_1 and K_2 are disjoint. Since X is locally convex, we can choose a convex open neighborhood U of 0 disjoint from $K_1 - K_2$. Proposition 4.16c shows that $K_1 - K_2$ is convex, and Lemma 4.20 therefore applies to the sets U and $K_1 - K_2$ and yields a nonzero continuous linear functional F such that

$$\operatorname{Re} F(U) \leq d \quad \text{and} \quad d \leq \operatorname{Re} F(K_1 - K_2)$$

for some real d . Since F is not zero, we can find x_0 in X with $F(x_0) = 1$. Choose $\epsilon > 0$ such that $|a| < \epsilon$ implies ax_0 is in U . Then

$$d \geq \operatorname{Re} F(U) \supseteq \operatorname{Re} F(\{ax_0 \mid |a| < \epsilon\}) = (-\epsilon, \epsilon),$$

and hence $d \geq \epsilon$. Therefore all k_1 in K_1 and k_2 in K_2 have

$$\operatorname{Re} F(k_1) - \operatorname{Re} F(k_2) = \operatorname{Re} F(k_1 - k_2) \geq d \geq \epsilon,$$

so that $\operatorname{Re} F(k_1) \geq \epsilon + \operatorname{Re} F(k_2)$. Taking $c = \inf_{k_1 \in K_1} \operatorname{Re} F(k_1)$ now yields the conclusion of the theorem. \square

Corollary 4.22. Let X be a locally convex topological vector space, let K be a closed convex subset of X , and let p be a point of X not in K . Then there exists a continuous linear functional F on X such that

$$\sup_{k \in K} \operatorname{Re} F(k) < \operatorname{Re} F(p).$$

PROOF. This is the special case of Theorem 4.21 in which the given compact set is a singleton set. \square

Corollary 4.23. If X is a locally convex topological vector space and if p and q are distinct points of X , then there exists a continuous linear functional F on X such that $F(p) \neq F(q)$.

PROOF. This is the special case of Corollary 4.22 in which the given closed convex set is a singleton set. \square

We conclude this section with a simple result about locally convex topological vector spaces that we shall need in the next section.

Proposition 4.24. If X is a locally convex topological vector space and Y is a closed vector subspace, then the topological vector space X/Y is locally convex.

REMARK. X/Y is a topological vector space by Proposition 4.4.

PROOF. Let E be an open neighborhood of a given point of X/Y . Without loss of generality, we may take the given point to be the 0 coset. If $q : X \rightarrow X/Y$ is the quotient map, $q^{-1}(E)$ is an open neighborhood of 0 in X . Since X is locally convex, there is a convex open neighborhood U of 0 in X with $U \subseteq q^{-1}(E)$. The map q carries open sets to open sets by Proposition 4.4 and carries convex sets to convex sets by Proposition 4.16d, and thus $q(U)$ is an open convex neighborhood of the 0 coset in X/Y contained in E . \square

7. Topology on $C_{\text{com}}^{\infty}(U)$

In this section we carry the discussion of local convexity in Sections 5–6 along the path toward applications to smooth functions. Our objective will be to topologize the space $C_{\text{com}}^{\infty}(U)$ of smooth functions of compact support on the open set U of \mathbb{R}^N . The members of $C_{\text{com}}^{\infty}(U)$ extend to functions in $C_{\text{com}}^{\infty}(\mathbb{R}^N)$ by defining them to be 0 outside U , and we often make this identification without special comment.

The important thing about the topology will be what it accomplishes, rather than what the open sets are, and we shall therefore work toward a characterization of the topology, together with an existence proof. The characterization will be in terms of a universal mapping property, and local convexity will be part of that property. Ultimately it is possible to give an explicit description of the open sets, but we leave such a description for Problem 9 at the end of the chapter. The explicit description will show in particular that the topology is given by an uncountable family of seminorms that cannot be reduced to a countable family except when U is empty.

Let us state the universal mapping property informally now, so that the ingredients become clear. Let K be any compact subset of the given open set U of \mathbb{R}^N ,

and define C_K^∞ to be the vector space of all smooth functions of compact support on \mathbb{R}^N with support contained in K . The space C_K^∞ becomes a locally convex topological vector space when we impose the countable family of seminorms $\|f\|_\alpha = \sup_{x \in K} |D^\alpha f(x)|$, with α running over all differentiation multi-indices. Set-theoretically, $C_{\text{com}}^\infty(U)$ is the union of all C_K^∞ as K runs through the compact subsets of U . The topology on $C_{\text{com}}^\infty(U)$ will be arranged so that

- (i) every inclusion $C_K^\infty \subseteq C_{\text{com}}^\infty(U)$ is continuous,
- (ii) whenever a linear mapping $C_{\text{com}}^\infty(U) \rightarrow X$ is given into a locally convex linear topological space X and the composition $C_K^\infty \rightarrow C_{\text{com}}^\infty(U) \rightarrow X$ is continuous for every K , then the given mapping $C_{\text{com}}^\infty(U) \rightarrow X$ is continuous.

It will automatically have the additional property

- (iii) every inclusion $C_K^\infty \subseteq C_{\text{com}}^\infty(U)$ is a homeomorphism with its image.

We shall proceed somewhat abstractly, so as to be able to construct the topology of a locally convex topological vector space out of simpler data. If (X, \mathcal{T}) is a topological space and p is in X , we define a **local neighborhood base** for \mathcal{T} at p to be a collection \mathcal{N}_p of neighborhoods of p , not necessarily open, such that if V is any open set containing p , then there exists N in \mathcal{N}_p with $N \subseteq V$. If X is a topological vector space with topology \mathcal{T} and if \mathcal{N}_0 is a local neighborhood base at 0, then $\{p + N \mid N \in \mathcal{N}_0\}$ is a local neighborhood base at p because translation by x is a homeomorphism. A set is open if and only if it is a neighborhood of each of its points. Consequently we can recover \mathcal{T} from a local neighborhood base \mathcal{N}_0 at 0 by this description: a subset V of X is open if and only if for each p in V , there exists N_p in \mathcal{N}_0 such that $p + N_p \subseteq V$.

Let us observe two properties of a local neighborhood base \mathcal{N}_0 at 0 for a topological vector space X . The first follows from the fact that X is Hausdorff, more particularly that each one-point subset of X is closed. The property is that for each $x \neq 0$ in X , there is some M_x in \mathcal{N}_0 with x not in M_x .

The second follows from the fact that 0 is an interior point of each member N of \mathcal{N}_0 . The property is that 0 is an internal point of N in the sense of Section 5. The fact that interior implies internal was proved in the first paragraph of the proof of Lemma 4.20.

We shall show in Lemma 4.25 that we can arrange in the locally convex case for each member N of a local neighborhood base \mathcal{N}_0 at 0 to have the additional property of being **circled** in the sense that $zN \subseteq N$ for all scalars z with $|z| \leq 1$.

Then we shall see in Proposition 4.26 that we can formulate a tidy necessary and sufficient condition for a system of sets containing 0 in a real or complex vector space X to be a local neighborhood base for a topology on X that makes X into a locally convex topological vector space.

Lemma 4.25. Any locally convex topological vector space has a local neighborhood base at 0 consisting of convex circled sets.

PROOF. It is enough to show that if V is an open neighborhood of 0, then there is an open subneighborhood U of 0 that is convex and circled. Since the underlying topological vector space is locally convex, we may assume that V is convex. Replacing V by $V \cap (-V)$, we may assume by parts (a) and (c) of Proposition 4.16 that V is stable under multiplication by -1 . Since V is convex, it follows that $cV \subseteq V$ for any real c with $|c| \leq 1$. If the field of scalars is \mathbb{R} , then the proof of the lemma is complete at this point.

Thus suppose that the field of scalars is \mathbb{C} . If V is a convex open neighborhood of 0, put

$$W = \{u \in V \mid zu \in V \text{ for all } z \in \mathbb{C} \text{ with } |z| \leq 1\}.$$

Then W is convex by Proposition 4.16a, and it is circled. Let us show that $W \supseteq \frac{1}{2}V \cap \frac{1}{2}iV$. Thus let u be an element of $\frac{1}{2}V \cap \frac{1}{2}iV$, and write it as $u = \frac{1}{2}v_1 = \frac{1}{2}iv_2$ with v_1 and v_2 in V . Let $z \in \mathbb{C}$ be given with $|z| \leq 1$, and let x and y be the real and imaginary parts of z . The vectors $\pm v_1$ and 0 are in V , and V is convex; since $|x| \leq 1$, xv_1 is in V . Similarly $-yv_2$ is in V . We can write $zu = \frac{1}{2}(x + iy)v_1 = \frac{1}{2}(xv_1) + \frac{1}{2}(-yv_2)$, and this is in V since V is convex. Therefore zu is in V , and u is in U . Hence $W \supseteq \frac{1}{2}V \cap \frac{1}{2}iV$, as asserted.

Let U be the interior W° of W . Then U is an open neighborhood of 0, and we show that it is convex and circled; this will complete the proof. Let u and v be in U . Since U is open, we can find an open neighborhood N of 0 such that $u + N \subseteq U$ and $v + N \subseteq U$. If n is in N and if t satisfies $0 \leq t \leq 1$, then $(1 - t)u + tv + n = (1 - t)(u + n) + t(v + n)$ exhibits $(1 - t)u + tv + n$ as a convex combination of a member of $u + N \subseteq W$ and a member of $v + N \subseteq W$, hence as a member of W . Therefore every member of $(1 - t)u + tv + N$ lies in W , and U is convex.

To see that U is circled, let u and N be as in the previous paragraph with $u + N \subseteq U$. If $|z| \leq 1$, then $u + N \subseteq W$ implies $z(u + N) \subseteq W$ since W is circled. Hence $zu + zN \subseteq W$. Since zN is open, $zu + zN$ is an open neighborhood of zu contained in W , and we must have $zu + zN \subseteq W^\circ = U$. Therefore U is circled. \square

Proposition 4.26. Let X be a real or complex vector space. If X has a topology making it into a locally convex topological vector space, then X has a local neighborhood base \mathcal{N}_0 at 0 for that topology such that

- (a) each N in \mathcal{N}_0 is convex and circled with 0 as an internal point,
- (b) whenever M and N are in \mathcal{N}_0 , there is some P in \mathcal{N}_0 with $P \subseteq M \cap N$,
- (c) whenever N is in \mathcal{N}_0 and a is a nonzero scalar, then aN is in \mathcal{N}_0 ,
- (d) each $x \neq 0$ in X has some associated M_x in \mathcal{N}_0 such that x is not in M_x .

Conversely if \mathcal{N}_0 is any family of subsets of the vector space X such that (a), (b), (c), and (d) hold, then there exists one and only one topology on X making X into a locally convex topological vector space in such a way that \mathcal{N}_0 is a local neighborhood base at 0.

PROOF. For the direct part of the proof, Lemma 4.25 shows that there is some local neighborhood base at 0 consisting of convex circled sets. To such a local neighborhood base we are free to add any additional neighborhoods of 0. Thus we may take \mathcal{N}_0 to consist of *all* convex circled neighborhoods of 0. Then (b) and (c) hold, and (d) holds since the topology is Hausdorff. Since 0 is an internal point of any neighborhood of 0, (a) holds. This proves existence.

For the converse there is only one possibility for the topology \mathcal{T} : V is open if for each x in V , there is some N_x in \mathcal{N}_0 with $x + N_x \subseteq V$. This proves the uniqueness of \mathcal{T} , and we are to prove existence. For existence we define open sets in this way and define \mathcal{T} to be the collection of all open sets. The definition makes \emptyset open and the arbitrary union of open sets open, and (b) makes the intersection of two open sets open.

We shall show that the complement of any $\{x_0\}$ is open. Then it follows by taking unions that X is open, so that \mathcal{T} is a topology; also we will have proved that every one-point set is closed. If $x_1 \neq x_0$, we use (d) to choose $M_{x_0-x_1}$ in \mathcal{N}_0 with $x_0 - x_1$ not in $M_{x_0-x_1}$. Then $x_1 + M_{x_0-x_1} \subseteq X - \{x_0\}$. Since x_1 is arbitrary, $X - \{x_0\}$ is open.

With \mathcal{T} established as a topology, let us see that every member of \mathcal{N}_0 is a neighborhood of 0. This step involves considering the family of sets aN for fixed N in \mathcal{N}_0 and for arbitrary positive a . If $0 < t < 1$ and if n_1 and n_2 are in N , then $(1-t)n_1 + tn_2$ is in N since (a) says that N is convex. Hence $(1-t)N + tN \subseteq N$. If $a > 0$ and $b > 0$, then we can take $t = b(a+b)^{-1}$ and obtain $a(a+b)^{-1}N + b(a+b)^{-1}N \subseteq N$. Multiplying by $a+b$ gives

$$aN + bN \subseteq (a+b)N \quad \text{for all positive } a \text{ and } b. \quad (*)$$

In particular the sets aN are nested for $a > 0$, i.e., $0 < a < a'$ implies $aN \subseteq a'N$.

From these facts we can show that each N in \mathcal{N}_0 is a neighborhood of 0. Given N , define $U = \bigcup_{0 < a < 1} aN$. This is a subset of N by the nesting property, and we shall prove that it is open. If x is in U , then x is in aN for some a with $0 < a < 1$, and (*) shows that $x + \frac{1}{2}(1-a)N \subseteq U$. By (c), $\frac{1}{2}(1-a)N$ is in \mathcal{N}_0 , and therefore $\frac{1}{2}(1-a)N$ can serve as a member N_x of \mathcal{N}_0 such that $x + N_x \subseteq U$. We conclude that U is open. Therefore N is a neighborhood of 0.

Next let us see that translations are homeomorphisms. If V is open and if x_0 is given, we know that each x in V has an associated N_x such that $x + N_x \subseteq V$. If y is in $x_0 + V$, then $x = y - x_0$ is in V and we see that $(y - x_0) + N_{y-x_0} \subseteq V$ and $y + N_{y-x_0} \subseteq x_0 + V$. Hence $x_0 + V$ is open, and every translation is a homeomorphism.

Let us see that addition is continuous at $(0, 0)$, and then the fact that translations are homeomorphisms implies that addition is continuous everywhere. If V is an open neighborhood of 0 , then the definition of open set says that there is some N in \mathcal{N}_0 with $0 + N \subseteq V$. By (c), $\frac{1}{2}N$ is in \mathcal{N}_0 . It is enough to prove that $(\frac{1}{2}N, \frac{1}{2}N)$ maps into V under addition. But this is immediate from (*) since $\frac{1}{2}N + \frac{1}{2}N \subseteq N \subseteq V$.

Next we investigate continuity of the mapping $x \mapsto ax$ for $a \neq 0$. It is enough to show that if V is open, then so is $a^{-1}V$. Since V is open, every x in V has an associated N_x in \mathcal{N}_0 such that $x + N_x \subseteq V$. The most general element of $a^{-1}V$ is of the form $a^{-1}x$ with x in V , and we have $a^{-1}x + a^{-1}N_x \subseteq a^{-1}V$. Since (c) shows $a^{-1}N_x$ to be in \mathcal{N}_0 , we conclude that $a^{-1}V$ is open.

Let us see that scalar multiplication is continuous at $(1, x)$, and then the fact that $x \mapsto ax$ is continuous for $a \neq 0$ implies that scalar multiplication is continuous everywhere except possibly at $(0, x)$. Let V be an open neighborhood of x , and choose N in \mathcal{N}_0 with $x + N \subseteq V$. Since N is in \mathcal{N}_0 , (c) shows that $\frac{1}{3}N$ is in \mathcal{N}_0 . Then 0 is an internal point of $\frac{1}{3}N$ by (a), and there exists $\epsilon > 0$ such that $-\epsilon \leq c \leq \epsilon$ implies that cx is in $\frac{1}{3}N$. There is no loss of generality in taking $\epsilon < 1$. Since $\frac{1}{3}N$ is circled by (a), cx is in $\frac{1}{3}N$ for $|c| \leq \epsilon$. Let A be the set of scalars with $|a - 1| < \epsilon$. We show that scalar multiplication carries $A \times (x + \frac{1}{3}N)$ into V . In fact, if a is in A and $\frac{1}{3}n_1$ is in $\frac{1}{3}N$, then $|a| < 2$, $\frac{1}{3}an_1$ is in $\frac{2}{3}N$, and (*) gives

$$a(x + \frac{1}{3}n_1) = (ax - x) + (x + \frac{1}{3}an_1) \in \frac{1}{3}N + (x + \frac{2}{3}N) \subseteq x + N \subseteq V.$$

To complete the proof of continuity of scalar multiplication, we show continuity at all points $(0, x)$. Let V be an open neighborhood of 0 in X , and choose N in \mathcal{N}_0 with $0 + N \subseteq V$. Since 0 is an internal point of N , there is some $\epsilon > 0$ such that cx is in N for real c with $|c| \leq \epsilon$. For this ϵ , $\frac{1}{2}\epsilon x$ is in $\frac{1}{2}N$. If $|z| < 1$ and y is in $\frac{1}{2}N$, then $(z, \frac{1}{2}\epsilon x + y)$ maps to $\frac{1}{2}z\epsilon x + zy$, which lies in $\frac{1}{2}N + \frac{1}{2}N$ since N is circled. In turn, this is contained in N by (*) and therefore is contained in V . So $(\frac{1}{2}\epsilon z, x + 2\epsilon^{-1}y)$ maps into V if $|z| < 1$ and y is in $\frac{1}{2}N$. Altering the definitions of z and y , we conclude that $(z, x + y)$ maps into V if $|z| < \frac{1}{2}\epsilon$ and y is in $\epsilon^{-1}N$. This proves the continuity.

Since $\{0\}$ is a closed set, Lemma 4.3 is applicable and shows that X is Hausdorff, hence is a topological vector space. Inside any open neighborhood V of 0 lies some set N in \mathcal{U}_0 , and $\bigcup_{0 < a < 1} aN$ is a convex open subneighborhood of V . Therefore the topology is locally convex. \square

We are almost in a position to topologize $C_{\text{com}}^{\infty}(U)$. If i_K denotes the inclusion of C_K^{∞} into $C_{\text{com}}^{\infty}(U)$, we shall define a convex circled subset N in $C_{\text{com}}^{\infty}(U)$

having 0 as an internal point to be in a local neighborhood base at 0 if $i_K^{-1}(N)$ is a neighborhood of 0 in C_K^∞ for every compact subset K of U . Then conditions (a), (b), and (c) in Proposition 4.26 will be met, and an examination of the proof of that proposition shows that we obtain a topology for $C_{\text{com}}^\infty(U)$ in which addition and scalar multiplication are continuous. What is lacking is the Hausdorff property, which follows once (d) holds in Proposition 4.26. Verifying (d) requires a construction, whose main step is given in the following lemma.

Lemma 4.27. Let X be a locally convex topological vector space, let Y be a closed vector subspace, and let Y be given the relative topology, which is locally convex. If N is a convex circled neighborhood of 0 in Y and x_0 is a point in X not in N , then there exists a convex circled neighborhood M of 0 in X such that $M \cap Y = N$ and such that x_0 is not in M .

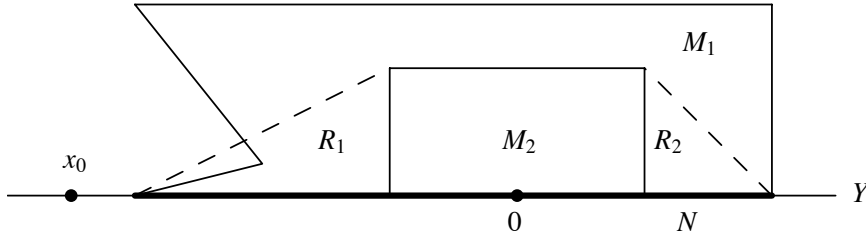

FIGURE 4.1. Extension of convex circled neighborhood of 0.
The lemma extends N to the set given in the figure
by $M_3 = R_1 \cup M_2 \cup R_2$.

PROOF. Since N is a neighborhood of 0 in Y and since Y has the relative topology, there exists a neighborhood M_1 of 0 in X such that $M_1 \cap Y = N$. We shall adjust M_1 to make it convex circled and to arrange that x_0 is not in it. Since X is locally convex, we can find a convex circled neighborhood M_2 of 0 contained in M_1 . Taking a cue from Figure 4.1, define

$$M_3 = \{(1-t)n + tm_2 \mid n \in N, m_2 \in M_2, 0 \leq t \leq 1\}.$$

This is a neighborhood of 0 since it contains M_2 , and it is convex circled since N and M_2 are convex circled.

We shall prove that

$$M_3 \cap Y = N.$$

Certainly $M_3 \cap Y \supseteq N$. For the reverse inclusion let m_3 be in $M_3 \cap Y$, and write $m_3 = (1-t)n + tm_2$ with $n \in N$, $m_2 \in M_2$, and $0 \leq t \leq 1$. If $t = 0$, then $m_3 = n$ is already in N . If $t > 0$, then $m_2 = t^{-1}(m_3 - (1-t)n)$ exhibits m_2 as a

linear combination of members of Y , hence as a member of Y . Since $M_2 \subseteq M_1$, m_2 is in $M_1 \cap Y = N$. Therefore m_3 is a convex combination of the members n and m_2 of N and must lie in N since N is convex. Consequently $M_3 \cap Y = N$.

If x_0 lies in Y , then we can take $M = M_3$ since x_0 is by assumption not in N and cannot therefore be in the larger set M_3 . If x_0 is not in Y , then Proposition 4.24 says that X/Y is a locally convex topological vector space. Since $x_0 + Y$ is not the 0 coset, we can find a convex circled neighborhood P of the 0 coset that does not contain $x_0 + Y$. If $q : X \rightarrow X/Y$ is the quotient map, then $q^{-1}(P)$ by Proposition 4.16e is a convex circled neighborhood of 0 in X that does not contain x_0 and satisfies $q^{-1}(P) \cap Y = Y$. Therefore $M = M_3 \cap q^{-1}(P)$ is a convex circled neighborhood of 0 in X that does not contain x_0 and satisfies $M \cap Y = N$. \square

Proposition 4.28. Let X be a real or complex vector space, and suppose that X is the increasing union $X = \bigcup_{p=1}^\infty X_p$ of a sequence of locally convex topological vector spaces such that for each p , X_p is a closed vector subspace of X_{p+1} and has the relative topology. Then there exists a unique topology on X making it into a locally convex topological vector space in such a way that

- (a) each inclusion $i_p : X_p \rightarrow X$ is continuous,
- (b) whenever $L : X \rightarrow Y$ is a linear function from X into a locally convex topological vector space Y such that $L \circ i_p : X_p \rightarrow Y$ is continuous for all p , then L is continuous.

This unique topology has the property that

- (c) each inclusion $i_p : X_p \rightarrow X$ is a homeomorphism with its image.

PROOF. Let \mathcal{N}_0 be the family of all convex circled subsets N of X having 0 as an internal point such that $i_p^{-1}(N)$ is a neighborhood of 0 in X_p for all p . We shall prove that \mathcal{N}_0 satisfies the four conditions (a) through (d) of Proposition 4.26, so that X has a unique topology making it into a locally convex topological vector space in such a way that \mathcal{N}_0 is a local neighborhood base at 0. Condition (a) holds by definition. Condition (b) holds because the intersection of two convex circled subsets with 0 as an internal point is again a convex circled set with 0 as an internal point and because the intersection of two neighborhoods is a neighborhood. Condition (c) holds because multiplication by a nonzero scalar sends convex circled sets with 0 as an internal point into convex circled sets with 0 as an internal point and because multiplication by a nonzero scalar sends neighborhoods of 0 to neighborhoods of 0.

We have to prove (d) in Proposition 4.26, namely that each $x_0 \neq 0$ in X has some associated M in \mathcal{N}_0 such that x_0 is not in M . Since $X = \bigcup_{p=1}^\infty X_p$, choose p_0 as small as possible so that x_0 is in X_{p_0} . Since X_{p_0} satisfies (a) through (d) and since $x_0 \neq 0$, we can find some convex circled neighborhood M_{p_0} of 0 in X_{p_0} that

does not contain x_0 . Proceeding inductively by means of Lemma 4.27, we can find, for each $p > p_0$, a convex circled neighborhood M_p of 0 in X_p that does not contain x_0 such that $M_p \cap X_{p-1} = M_{p-1}$. Define $M = \bigcup_{p \geq p_0} M_p$. Then M is convex circled since each M_p has this property. To see that 0 is an internal point of M , we argue as follows: for each x in X , x lies in some X_p , the set M_p has 0 as an internal point since M_p is a neighborhood of 0, M_p contains all cx for c real and small, and the larger set M contains all cx for c real and small. For each $p \geq p_0$, the set $i_p^{-1}(M)$ equals M_p , which was constructed as a neighborhood of 0 in X_p . The intersection $i_k^{-1}(M) = M_p \cap X_k$ has to be a neighborhood of 0 in X_k for $k < p$ since M_p is a neighborhood of 0 in X_p , and the set M is therefore in \mathcal{N}_0 . Thus M meets the requirement of being a member of \mathcal{N}_0 that does not contain x_0 , and (d) holds in Proposition 4.26.

We are left with proving (a) through (c) in the present proposition and with proving that no other topology meets these conditions. For (a), since i_p is linear, it is enough to prove continuity at 0. Hence we are to see that if N is in \mathcal{N}_0 , then $i_p^{-1}(N)$ is a neighborhood of 0 in X_p . But this is just one of the defining conditions for the set N to be in \mathcal{N}_0 .

For (b), since L is linear, it is enough to prove continuity at 0. Since Y is locally convex, the convex circled neighborhoods of 0 in Y form a local neighborhood base. If E is such a neighborhood, we are to show that $N = L^{-1}(E)$ is a neighborhood of 0 in X . The set E is convex and circled with 0 as an internal point, and hence the same thing is true of N . Also, $i_p^{-1}(N) = i_p^{-1}L^{-1}(E) = (L \circ i_p)^{-1}(E)$ is a neighborhood of 0 in X_p since $L \circ i_p$ is by assumption continuous. Therefore $N = L^{-1}(E)$ is in \mathcal{N}_0 , and then $L^{-1}(E)$ is a neighborhood of 0 in the topology imposed on X . Hence L is continuous at 0 and is continuous.

For (c), we again use Lemma 4.27, except that this time we do not need a point x_0 . We are to show that if N_{p_0} is a neighborhood of 0 in X_{p_0} , then $i(N_{p_0})$ is a neighborhood of 0 in the relative topology that X defines on X_{p_0} . Since X_{p_0} is locally convex, there is no loss of generality in assuming that N_{p_0} is convex circled. Proceeding inductively for $p > p_0$, we use the lemma to construct a convex circled neighborhood N_p of 0 in X_p such that $N_p \cap X_{p-1} = N_{p-1}$. Put $N = \bigcup_{p \geq p_0} N_p$. Arguing in the same way as earlier in the proof, we see that N is in \mathcal{N}_0 . Then $i(N_{p_0}) = X_{p_0} \cap N$, and $i(N_{p_0})$ is exhibited as the intersection of X_{p_0} with a neighborhood of 0 in X . This proves (c).

Finally suppose that the constructed topology on X is \mathcal{T} and that \mathcal{T}' is a second topology making X into a locally convex topological vector space in such a way that (a) and (b) hold. Let $1_{\mathcal{T}}$ be the identity map from (X, \mathcal{T}) to (X, \mathcal{T}') . By (a) for \mathcal{T}' , the composition $1_{\mathcal{T}} \circ i_p : X_p \rightarrow X$ is continuous. By (b) for \mathcal{T} , $1_{\mathcal{T}}$ is continuous from (X, \mathcal{T}) to (X, \mathcal{T}') . Reversing the roles of \mathcal{T} and \mathcal{T}' , we see that the identity map is continuous from (X, \mathcal{T}') to (X, \mathcal{T}) . Therefore $1_{\mathcal{T}}$ is a homeomorphism. \square

In the terminology of abstract functional analysis, one says that X in Proposition 4.28 is a **strict inductive limit**¹⁶ of the spaces X_p . With extra hypotheses that are satisfied in our case of interest, one says that X acquires the **LF topology**¹⁷ from the X_p 's.

Now let us apply the abstract theory to $C_{\text{com}}^{\infty}(U)$. If $\{K_p\}$ is any exhausting sequence of compact subsets of U , then we apply Proposition 4.28 with $X = C_{\text{com}}^{\infty}(U)$ and $X_p = C_{K_p}^{\infty}$. For the inclusion $X_p \subseteq X_{p+1}$, the restriction to $C_{K_p}^{\infty}$ of the seminorms on $C_{K_{p+1}}^{\infty}$ yields the seminorms for $C_{K_p}^{\infty}$, and therefore X_p has the relative topology as a vector subspace of X_{p+1} . The space X_p is a closed subspace because $C_{K_p}^{\infty}$ is Cauchy complete and because complete subsets of a metric space are closed. Thus the hypotheses are satisfied, and $C_{\text{com}}^{\infty}(U)$ acquires a unique topology as a locally convex topological vector space such that

- (i) each inclusion $C_{K_p}^{\infty} \subseteq C_{\text{com}}^{\infty}(U)$ is continuous,
- (ii) whenever a linear mapping $C_{\text{com}}^{\infty}(U) \rightarrow X$ is given into a locally convex linear topological space X and the composition $C_{K_p}^{\infty} \rightarrow C_{\text{com}}^{\infty}(U) \rightarrow X$ is continuous for every p , then the given mapping $C_{\text{com}}^{\infty}(U) \rightarrow X$ is continuous.

Furthermore

- (iii) each inclusion $C_{K_p}^{\infty} \subseteq C_{\text{com}}^{\infty}(U)$ is a homeomorphism with its image.

To complete our construction, all we have to do is show that the resulting topology on $C_{\text{com}}^{\infty}(U)$ does not depend on the choice of exhausting sequence.

Proposition 4.29. The inductive limit topology on $C_{\text{com}}^{\infty}(U)$ is independent of the choice of exhausting sequence. Consequently

- (a) each inclusion $C_K^{\infty} \subseteq C_{\text{com}}^{\infty}(U)$ is a homeomorphism with its image,
- (b) whenever a linear mapping $C_{\text{com}}^{\infty}(U) \rightarrow X$ is given into a locally convex linear topological space X and the composition $C_K^{\infty} \rightarrow C_{\text{com}}^{\infty}(U) \rightarrow X$ is continuous for every compact subset K of U , then the given mapping $C_{\text{com}}^{\infty}(U) \rightarrow X$ is continuous.

¹⁶The words “direct limit” mean the same thing as “inductive limit,” but “inductive” is more common in this situation. The term “strict” refers to the fact that the successive inclusions $i_{p+1,p} : X_p \rightarrow X_{p+1}$ are one-one with $i_{p+1,p}(X_p)$ homeomorphic to X_p . The notion of “direct limit” is a construction in category theory that is useful within several different categories. Uniqueness of the direct limit up to canonical isomorphism is a formality built into the definition; existence depends on the particular category. For this situation the construction is taking place within the category of locally convex topological vector spaces (and continuous linear maps). A direct-limit construction within a different category plays a role in Problems 26–30 at the end of the chapter, and those problems are continued at the end of Chapter VI.

¹⁷“ LF ” refers to “Fréchet limit.” In the usual situation the spaces X_p are assumed to be locally convex complete metric topological vector spaces, i.e., “Fréchet spaces.” The X_p 's have this property in the application to $C_{\text{com}}^{\infty}(U)$.

PROOF. Write X for $C_{\text{com}}^{\infty}(U)$ with its topology defined relative to an exhausting sequence $\{K_p\}$ of compact subsets of U , and write Y for $C_{\text{com}}^{\infty}(U)$ with its topology defined relative to an exhausting sequence $\{K'_p\}$. If K_k is a member of the sequence $\{K_p\}$, then $K_k \subseteq K'_p$ for $p \geq$ some index p_0 depending on k since the interiors of the sets K'_p cover the compact set K_k . The inclusion $K_k \subseteq K'_p$ is continuous for $p \geq p_0$, and therefore the composition $K_k \rightarrow K'_{p_0} \rightarrow Y$ is continuous. This continuity for all k implies that the identity map from X into Y is continuous. Reversing the roles of X and Y , we see that the identity map is a homeomorphism. \square

8. Krein–Milman Theorem

In this section we carry the discussion of local convexity in Sections 5–6 along the path toward fixed-point theorems. Our objective will be to prove a fundamental existence theorem about “extreme points.”

If K is a convex set in a real or complex vector space and if x_0 is in K , we say that x_0 is an **extreme point** of K if x_0 is not in the interior of any **line segment** belonging to K , i.e., if

$$x_0 = (1-t)x + ty \text{ with } 0 < t < 1 \text{ and } x, y \in K \quad \text{implies} \quad x_0 = x = y.$$

Let X be a topological vector space, and let K be a closed convex subset of X . A nonempty closed convex subset S of K is called a **face** if whenever ℓ is a line segment belonging to K , in the above sense, and ℓ has an interior point in S , then the whole line segment belongs to S . With this definition, x_0 is an extreme point of K if and only if the singleton set $\{x_0\}$ is a face.

If E is a subset of X , then the **closed convex hull** of E is defined to be the intersection of all closed convex subsets of X that contain E . It may be described explicitly as the closure of the set of all convex combinations of members of E .

Theorem 4.30 (Krein–Milman Theorem). If K is a compact convex set in a locally convex topological vector space, then K is the closed convex hull of the set of extreme points of K . In particular, if K is nonempty, then K has an extreme point.

PROOF. Let X be the underlying topological vector space. We may assume, without loss of generality, that K is nonempty. Let us see that if f is any continuous linear functional on X , then the subset of K on which $\text{Re} f$ assumes its maximum value is a face. In fact, let S be the subset where $g = \text{Re} f$ assumes its maximum value m . Then S is nonempty since K is compact and g is continuous, and the continuity and real linearity of g imply that S is closed and convex. To

check that S is a face, let x_0 be in S , and suppose that $x_0 = (1 - t)x + ty$ with $0 < t < 1$ and x, y in K . Then

$$m = g(x_0) = (1 - t)g(x) + tg(y) \leq m(1 - t) + tm = m.$$

Equality must hold throughout, and therefore $g(x) = m = g(y)$. Hence x and y are in S , and S is a face.

Next let us see that any face of K contains an extreme point. In fact, order the faces by inclusion downward. The intersection of a chain of faces is nonempty by compactness and hence is a face that provides a lower bound for the chain. By Zorn's Lemma there exists a minimal face S_1 . Arguing by contradiction, suppose that S_1 contains at least two points. Then Corollary 4.23 and the local convexity of X yield a continuous linear functional whose real part takes distinct values at the two points. From the previous paragraph we find that S_1 contains a proper face S . A face of a face is a face. Thus S is a face of K strictly smaller than the minimal face S_1 , and we arrive at a contradiction.

Now we can complete the proof. If E denotes the closed convex hull of the set of extreme points of K , then certainly $E \subseteq K$. Arguing by contradiction, suppose that equality fails: Let x_0 be in K but not in E . Then Corollary 4.22 and the local convexity of X produce a continuous linear functional whose real part has supremum on E strictly less than the value at x_0 . The first paragraph of the proof shows that the subset of K where the real part of this linear functional takes the value at x_0 is a face of K , and the second paragraph shows that this face has an extreme point. This extreme point is not in E , and we arrive at a contradiction. \square

Compact convex subsets of \mathbb{R}^N arise in practical maximum–minimum problems involving several variables, typically economic variables. Often the compact convex set is a polyhedron, and the function to be maximized is the sum of a constant and a linear function. The Krein–Milman Theorem produces extreme points, and the basic techniques of the subject of linear programming show that the maximum is attained at an extreme point and show how to find this extreme point.

A natural place where infinite-dimensional compact convex sets arise is in the weak-star topology on the closed unit ball of the dual of a normed linear space. Alaoglu's Theorem says that this set is compact, and it is certainly convex. The Hahn–Banach Theorem is what shows that this compact convex set contains a nonzero element when the normed linear space is nonzero.

When the whole closed unit ball is the set of interest, let us see what the extreme points are like in certain situations. If the underlying normed linear space is a Hilbert space, then the real part of a continuous linear functional takes its maximum value at a single point of the closed unit ball. The upshot of this fact is that the proof of the Krein–Milman Theorem above degenerates; Zorn's

Lemma is not needed, for example, to produce an extreme point. The proof degenerates in the same way, in fact, whenever one considers some L^p space with $1 < p < \infty$.

The case of L^∞ is more interesting. Let us work with real-valued functions in the context of a σ -finite measure space, regarding L^∞ as the dual of L^1 . The extreme points of the closed unit ball are all the L^∞ functions that take only the values -1 and $+1$.

Similarly we can consider the space $C([0, 1])$ of continuous functions on $[0, 1]$. Again let us work with real-valued functions. Suppose that this Banach space is the dual of some normed linear space. Then the closed unit ball of $C([0, 1])$ forms a compact convex set in the weak-star topology. As with L^∞ , the extreme points are the functions that take only the values -1 and $+1$. The functions have to be continuous, however, and they are therefore constant. So we get only two extreme points, the constant functions -1 and $+1$, and their closed convex hull contains only constant functions. The conclusion is that $C([0, 1])$ is not the dual of any normed linear space.

We can argue similarly with measures and L^1 functions. Suppose that X is a compact Hausdorff space. The Banach space $M(X)$ of regular complex Borel measures on X is the dual of $C(X)$, and the set of nonnegative Borel measures of total mass ≤ 1 is a closed compact subset of the unit ball in the weak-star topology. This set has to be the closed convex hull of its extreme points. Indeed, as is pointed out in Problem 17 at the end of the chapter, the extreme points of this set are 0 and the point masses of mass 1 at the points of X ; the statement of the theorem is reflected in the fact that any regular Borel measure on X with total mass ≤ 1 is a weak-star limit of linear combinations of point masses.

We can consider similarly the space $L^1([0, 1])$ of Borel functions on $[0, 1]$ integrable with respect to Lebesgue measure. Suppose that this Banach space is the dual of some normed linear space. Then the closed unit ball of $L^1([0, 1])$ forms a compact convex set in the weak-star topology. Problem 18 at the end of the chapter shows that the extreme points are trying to be the functions whose mass is concentrated at a single point, and there are none. The conclusion is that $L^1([0, 1])$ is not the dual of any normed linear space.

The Krein–Milman Theorem begins to show its power when applied to more subtle closed convex subsets of a unit ball in the weak-star topology. Here is an example that lies behind the foundations of the theory of locally compact abelian groups.¹⁸ For concreteness we work with complex-valued functions on the integers, i.e., doubly infinite sequences. Such a function $f(n)$ is said to be **positive definite** if $\sum_{j,k} c(j)f(j-k)\overline{c(k)} \geq 0$ for all functions $c(n)$ on the integers with finite support. Positive definite functions are easily checked to

¹⁸Such groups are defined in Chapter VI.

have $f(0) \geq 0$ and $|f(n)| \leq f(0)$. In particular, the set K of positive definite functions f with $f(0) = 1$ may be regarded as a subset of the closed unit ball of L^∞ of the integers with the counting measure, a space sometimes called ℓ^∞ . Weak-star convergence for such functions is the same as pointwise convergence, and it follows that K is closed, hence compact. Checking the definition, we see that K is convex. The Krein–Milman Theorem tells us that K is the closed convex hull of its extreme points. It is shown in Problem 20 at the end of the chapter that the extreme points are the functions $f_\theta(n) = e^{in\theta}$ for real θ .

By way of introduction to the next section, let us consider one more example. Let S be a compact Hausdorff space, and let F be any homeomorphism of S . Put $X = C(S)$. In the weak-star topology on $M(S)$, the nonnegative regular Borel measures μ with $\mu(S) = 1$ form a compact convex subset K_1 of $M(S)$. The Markov–Kakutani Theorem in the next section shows that there exist elements of K_1 invariant under F . The invariant such measures therefore form a nonempty compact convex subset K of K_1 . According to the Krein–Milman Theorem, K is the closed convex hull of its set of extreme points. As shown in Problem 19 at the end of the chapter, the μ 's that are extreme points have the interesting property that all Borel subsets that are carried onto themselves by the homeomorphism F have measure 0 or 1; the usual name for this phenomenon is that μ is **ergodic** with respect to F . Since the Krein–Milman Theorem is saying that extreme points exist, we obtain the consequence that for each homeomorphism F of S , there is some regular Borel measure μ with $\mu(S) = 1$ that is ergodic with respect to F .

9. Fixed-Point Theorems

In this section we continue the discussion of convexity and local convexity. We shall give two fixed-point theorems.

Theorem 4.31 (Markov–Kakutani Theorem). Let K be a compact convex set in a topological vector space X , and let \mathcal{F} be a commuting family of continuous linear mappings carrying K into itself. Then there exists a point p in K such that $T(p) = p$ for all T in \mathcal{F} .

PROOF. For each integer $n \geq 1$ and member T of \mathcal{F} , let

$$T_n = \frac{1}{n}(I + T + T^2 + \cdots + T^{n-1}).$$

Let \mathcal{K} be the family of all subsets of X that arise as $T_n(K)$ for some $n \geq 1$ and some T in \mathcal{F} . Each such set is a compact convex subset of K , being the image of a compact convex set under a continuous linear mapping that carries K into itself. If $\{T_{n_i}^{(i)}\}_{i=1}^r$ is a finite subset of \mathcal{F} and each $n_i \geq 1$, then

$$T_{n_1}^{(1)} T_{n_2}^{(2)} \cdots T_{n_r}^{(r)}(K) \subseteq T_{n_1}^{(1)} T_{n_2}^{(2)} \cdots T_{n_{r-1}}^{(r-1)}(K) \subseteq \cdots \subseteq T_{n_1}^{(1)}(K).$$

By symmetry and commutativity of the operators,

$$T_{n_1}^{(1)} T_{n_2}^{(2)} \cdots T_{n_r}^{(r)}(K) \subseteq \bigcap_{j=1}^r T_{n_j}^{(j)}(K).$$

Thus the members of \mathcal{K} have the finite-intersection property. By compactness their intersection is nonempty. Let p be in the intersection. We shall show that $T(p) = p$ for all T in \mathcal{F} .

Arguing by contradiction, suppose that T is given in \mathcal{F} with $T(p) \neq p$. Choose a neighborhood U of 0 in X such that $T(p) - p$ is not in U . The fact that p is in the intersection of all the sets in \mathcal{K} implies that p is in $T_n(K)$ for $n \geq 1$ and thus

$$p = n^{-1}(I + T + T^2 + \cdots + T^{n-1})(q_n)$$

for some q_n in K . Applying $T - I$ to this equality, we obtain

$$T(p) - p = n^{-1}(T^n - I)(q_n).$$

Since the left side is not in U , the right side is not in U . Since $T^n(q_n)$ and q_n are in K , it follows that $\frac{1}{n}(K - K)$ is not contained in U for any n . But $K - K$ is a compact set, being the image under the subtraction mapping of the compact set $K \times K$, and this conclusion contradicts Lemma 4.7. \square

Let us return to the example at the end of the previous section. As in that example, let S be a compact Hausdorff space, and let F be any homeomorphism of S . Put $X = C(S)$. In the weak-star topology on $M(S)$, the nonnegative regular Borel measures μ with $\mu(S) = 1$ form a compact convex subset K_1 of $M(S)$. The homeomorphism F acts on $M(S)$ by the formula $T_F(\rho)(E) = \rho(F^{-1}(E))$. The mapping T_F is linear, and it follows from the definitions that T_F satisfies $\|T_F(\rho)\|_{M(S)} = \|\rho\|_{M(S)}$. Thus T_F has norm 1 and is continuous. It maps K_1 into itself. Putting $\mathcal{F} = \{T_F\}$ and applying Theorem 4.31, we obtain the existence of a nonzero F invariant measure on S . The discussion in the previous section went on to observe that the subset K of F invariant measures in K_1 , which we now know to be nonempty, is compact convex in a locally convex topological vector space. Thus K is a set to which we can apply the Krein–Milman Theorem, and the extreme points turn out to be the ergodic invariant measures.

Theorem 4.32 (Schauder–Tychonoff Theorem). Let K be a compact convex set in a locally convex topological vector space, and let F be a continuous function from K into itself. Then there exists p in K with $F(p) = p$.

The proof of Theorem 4.32 is long and will be omitted.¹⁹ The power in the result comes from its applicability to nonlinear mappings. In the special case in which K is the closed unit ball in \mathbb{R}^N , it reduces to the celebrated Brouwer Fixed-Point Theorem.

This kind of theorem has applications to economics, where fixed-point theorems prove the existence of equilibrium points for certain systems. The theorem does not by itself address stability of such an equilibrium point, however.

By way of illustration, let us return to a comparatively simple situation that was studied in Chapter IV of *Basic*. The usual Picard–Lindelöf Existence Theorem²⁰ for the initial-value problem with a system $y' = f(t, y)$ of ordinary differential equations assumes continuity of f and also a Lipschitz condition for f in the y variable. A variant, the Cauchy–Peano Existence Theorem, is the subject of problems at the end of Chapter IV of *Basic*. It assumes only continuity for f and obtains existence of solutions, with uniqueness being lost. The Cauchy–Peano result is proved using Ascoli’s Theorem and a nonobvious construction.

Ascoli’s Theorem, as we know from Section X.9 of *Basic*, is intimately connected with compactness. Let us see how to combine Ascoli’s Theorem and the Schauder–Tychonoff Theorem to obtain a more transparent proof of the Cauchy–Peano result than was suggested in the problems at the end of Chapter IV of *Basic*. To keep the notation simple, we stick with the case of a single equation, rather than a system. We suppose that $f(t, y)$ is continuous on an open subset D of \mathbb{R}^2 . Let (t_0, y_0) be in D , and let R be a closed rectangle in D centered at (t_0, y_0) and having the form

$$R = \{(t, y) \mid |t - t_0| \leq a \text{ and } |y - y_0| \leq b\}.$$

Suppose that $|f(t, y)| \leq M$ on R . Put $a' = \min\{a, \frac{b}{M}\}$. The theorem is that there exists a continuously differentiable solution $y(t)$ to the initial-value problem $y' = f(t, y)$, $y(t_0) = y_0$, $|t - t_0| < a'$.

For the proof let X be the Banach space $C(\{t \mid |t - t_0| \leq a'\})$, and let K be the closure of the set

$$E = \left\{ y \in X \mid \begin{array}{l} \text{(i) } y(t_0) = y_0, \\ \text{(ii) } y' \text{ is continuous for } |t - t_0| \leq a', \\ \text{(iii) } |y'(t)| \leq M \text{ for } |t - t_0| \leq a' \end{array} \right\}$$

in the Banach space X . Condition (iii) makes E an equicontinuous family, and (i) and (iii) together make E pointwise bounded. Lemma 10.47 of *Basic* shows that the closure K is equicontinuous and pointwise bounded. Ascoli’s Theorem

¹⁹A proof may be found in Dunford–Schwartz’s *Linear Operators*, Part I, pp. 453–456 and 467–469.

²⁰Theorem 4.1 of *Basic*.

therefore shows that K is compact. Define a function F carrying the space K of functions to another space of functions by

$$F(y)(t) = y_0 + \int_{t_0}^t f(s, y(s)) ds.$$

For y in E , we have $|y(s) - y_0| \leq M|s - t_0| \leq Ma' \leq b$, and thus $(s, y(s))$ is in the rectangle R . Hence $F(y)$ satisfies (i), (ii), and (iii) and is in E . So F carries E to itself. The formula for F makes clear that F extends to a continuous mapping on K in the supremum-norm topology. Since $F(E) \subseteq E$, we obtain $F(K) \subseteq K$. The set K is compact convex in a Banach space, which is locally convex. The Schauder–Tychonoff Theorem applies to F , and the fixed point it produces is the desired solution.

10. Gelfand Transform for Commutative C^* Algebras

Alaoglu's Theorem, obtained in Section 3, leads in several directions in functional analysis, and we now return to its ramifications for spectral theory. The Stone Representation Theorem in Section 4 gave a concrete example of what we shall be investigating, showing that certain subalgebras of the algebra $B(S)$ of all complex-valued bounded functions on a set S can be realized as the algebra of all complex-valued continuous functions on a suitable compact Hausdorff space. The present section is devoted to a generalization due to I. M. Gelfand of this result to certain algebras besides $B(S)$; a different special case of this generalization will yield in the next section the Spectral Theorem for bounded self-adjoint operators on a Hilbert space.

Recall from Section 4 that a complex **Banach algebra** \mathcal{A} is a complex associative algebra having a norm that makes it into a Banach space such that $\|ab\| \leq \|a\|\|b\|$ for all a and b in \mathcal{A} . We shall not consider $\mathcal{A} = 0$ as a Banach algebra. Nor shall we have any occasion to consider real Banach algebras. The inequality concerning the norm under multiplication implies that multiplication is continuous. If the Banach algebra has an identity, the same inequality implies that $\|1\| \geq 1$.

EXAMPLES.

(1) If S is a nonempty set, then the algebra $B(S)$ of all bounded complex-valued functions on S is a commutative Banach algebra. The function 1 is an identity. If S has a topology, then the subalgebra $C(S)$ of bounded continuous functions gives another example of a commutative Banach algebra with identity.

(2) If (S, μ) is a σ -finite measure space, then pointwise multiplication and the essential-supremum norm make $L^\infty(S, \mu)$ into a commutative Banach algebra with identity.

(3) In Euclidean space \mathbb{R}^N , the Banach space $L^1(\mathbb{R}^N)$ with Lebesgue measure becomes a commutative Banach algebra with convolution as multiplication: $(f * g)(x) = \int_{\mathbb{R}^N} f(x-y)g(y) dy = \int_{\mathbb{R}^N} f(y)g(x-y) dy$. This Banach algebra does not have an identity. A variant of this Banach algebra may be defined using functions on \mathbb{R}^N periodic in each variable with period 2π , the measure being $(2\pi)^{-N} dx$, and convolution being the multiplication. Still another variant uses functions on \mathbb{Z}^N integrable with respect to the counting measure, and convolution is again the multiplication.

4) If H is a complex Hilbert space, then the algebra $\mathcal{B}(H, H)$ of all bounded linear operators from H to itself is a Banach algebra with identity when the norm is the operator norm and the multiplication is composition of operators.

The example of L^1 is so important that one does not want automatically to impose a condition on a Banach algebra that it contain an identity. Nevertheless, it is always possible to adjoin an identity to a Banach algebra if one wants, as the following proposition shows.

Proposition 4.33. Let \mathcal{A} be a complex Banach algebra, and let

$$\mathcal{B} = \{(a, \lambda) \mid a \text{ is in } \mathcal{A} \text{ and } \lambda \text{ is in } \mathbb{C}\} = \mathcal{A} \oplus \mathbb{C}$$

as a vector space. Define

$$(a, \lambda)(b, \mu) = (ab + \lambda b + \mu a, \lambda\mu)$$

and

$$\|(a, \lambda)\| = \|a\| + |\lambda|.$$

Then \mathcal{B} is a complex Banach algebra with identity $(0, 1)$, and the map $a \mapsto (a, 0)$ is a norm-preserving algebra homomorphism of \mathcal{A} onto a closed ideal in \mathcal{B} .

REMARKS. The formula for the multiplication is motivated by expansion of the product $(a + \lambda)(b + \mu)$, and the formula for the norm is motivated by the norm of the element $f dx + \delta_0$ in $M(\mathbb{R}^N)$, where δ_0 is a point mass of weight 1 at the origin. We omit the proof of the proposition, since we shall not pursue L^1 very far from this point of view.

To proceed further, let us go back to our examples and see what can be said about them. For $B(S)$ in Example 1, the Stone Representation Theorem realized certain subalgebras as $C(X)$ for some compact Hausdorff space X . The space X is the space of all nonzero continuous multiplicative linear functionals respecting complex conjugation, regarded as a closed subset of the set of all continuous linear functionals of norm ≤ 1 with the weak-star topology. Evaluations at points of S provide examples of members of X , and X is just the closure of those evaluations.

To what extent might multiplicative linear functionals help us understand the other examples? For L^∞ in Example 2, the notion of multiplicative linear functional is meaningful, but it is not clear that any nonzero ones exist. At points of the measure space of positive measure, evaluations are well defined and yield multiplicative linear functionals. But if every one-point set of the measure space has measure 0, then it is not clear how to proceed.

For L^1 in Example 3, the answer is more decisive. The most general continuous linear functional is integration with an L^∞ function, and the nonzero continuous multiplicative linear functionals are the ones where the L^∞ function is an exponential $x \mapsto e^{ix \cdot y}$ for some y in \mathbb{R}^N . Let us sketch the argument. If a multiplicative linear functional ℓ is given by the nonzero L^∞ function φ , then the condition $\ell(f * g) = \ell(f)\ell(g)$ translates into the condition

$$\int_{\mathbb{R}^N \times \mathbb{R}^N} f(x)g(y)\varphi(x+y) dx dy = \int_{\mathbb{R}^N \times \mathbb{R}^N} f(x)g(y)\varphi(x)\varphi(y) dx dy.$$

Since f and g are arbitrary, $\varphi(x+y) = \varphi(x)\varphi(y)$ a.e. $[dx dy]$. Letting p be in $C_{\text{com}}(\mathbb{R}^N)$ and integrating this equation with $p(y)$ gives

$$\int_{\mathbb{R}^N} p(y)\varphi(x+y) dy = \varphi(x) \int_{\mathbb{R}^N} p(y)\varphi(y) dy \quad \text{a.e. } [dx].$$

The left side, upon the change of variables $y \mapsto -y$, is the convolution of a function in $C_{\text{com}}(\mathbb{R}^N)$ and a function in $L^\infty(\mathbb{R}^N)$. It is therefore continuous as a function of x . On the right side some p has $\int_{\mathbb{R}^N} p(y)\varphi(y) dy \neq 0$ since φ is not the 0 function almost everywhere. Fixing such a p and dividing by $\int_{\mathbb{R}^N} p(y)\varphi(y) dy$, we see that $\varphi(x)$ is almost everywhere equal to a certain continuous function. We may therefore adjust φ on a set of measure 0 to be continuous. Once adjusted, φ satisfies $\varphi(x+y) = \varphi(x)\varphi(y)$ everywhere. It is then a simple matter to see that φ is an exponential, as asserted.

Example 4 is something like Example 2. Suppose that A is a bounded self-adjoint operator on the Hilbert space H . We can form the smallest subalgebra of $\mathcal{B}(H, H)$ containing A and the identity, and we can look for multiplicative linear functionals. Theorem 2.3 addresses a situation in which we can identify such functionals. If A is compact, then the theorem gives an orthonormal basis of eigenvectors, and every member of this algebra acts as a scalar on each eigenvector. So each eigenvector yields, via the corresponding set of eigenvalues, a multiplicative linear functional. If A is not compact, however, eigenvectors need not exist, and then it is unclear where to look to find nonzero multiplicative linear functionals.

A series of theoretical insights now comes into play. An associative algebra with identity need not have nonzero multiplicative linear functionals, but it always

has maximal ideals. These come from Zorn's Lemma, the proper ideals being those ideals not containing the identity. Accordingly, we shall think in terms of maximal ideals. These turn out to be closed, because as we shall see, there is a neighborhood of the identity where every element is invertible with an inverse given by the sum of a geometric series. The quotient of a commutative complex Banach algebra with identity by a (closed) maximal ideal is then a complex Banach algebra in which every nonzero element is invertible. The remarkable fact is that such a quotient necessarily is 1-dimensional. Then it follows that the maximal ideals all correspond to continuous multiplicative linear functionals after all, and their existence has been established. Let us run through the steps.

Let \mathcal{A} be a Banach algebra with identity, at first not necessarily commutative. If a is in \mathcal{A} , then a **right inverse** to a is an element b with $ab = 1$. If a has a right inverse b and if a has a **left inverse** c , then the two are equal as a consequence of the associativity of multiplication: $c = c1 = c(ab) = (ca)b = 1b = b$. So a has a two-sided inverse, which we call simply an **inverse**, and we say that a is **invertible**.

Proposition 4.34. Let \mathcal{A} be a Banach algebra with identity. If $\|a\| < 1$, then $1 - a$ is invertible and $\|(1 - a)^{-1}\| \leq (1 - \|a\|)^{-1}$.

PROOF. Form $\sum_{n=0}^{\infty} a^n$. This series is Cauchy since $\|a^n\| \leq \|a\|^n$ implies $\|\sum_{n=M}^N a^n\| \leq \sum_{n=M}^N \|a\|^n \leq \|a\|^M (1 - \|a\|)^{-1}$. Since \mathcal{A} is complete, the series $\sum_{n=0}^{\infty} a^n$ is convergent. Let b be its sum. Then we have $(1 - a)(\sum_{n=0}^{\infty} a^n) = (\sum_{n=0}^{\infty} a^n)(1 - a) = 1 - a^{\infty}$, and hence $(1 - a)b = b(1 - a) = 1$. Also, $\|b\| \leq \sum_{n=0}^{\infty} \|a\|^n = (1 - \|a\|)^{-1}$. \square

Corollary 4.35. In a Banach algebra with identity, the invertible elements form an open set. More particularly if $\|a\|$ is invertible and $\|x - a\| < \|a^{-1}\|^{-1}$, then x is invertible.

PROOF. Let U be the set of invertible elements, and let a be in U . If $\|x - a\| < \|a^{-1}\|^{-1}$, then

$$\|a^{-1}x - 1\| = \|a^{-1}(x - a)\| \leq \|a^{-1}\| \|x - a\| < 1,$$

and Proposition 4.34 shows that $1 - (1 - a^{-1}x) = a^{-1}x$ is invertible. Hence x is invertible. \square

Proposition 4.36. If \mathcal{A} is a Banach algebra with identity and U is the open set of invertible elements, then inversion is a continuous map of U into itself.

PROOF. Let a be in U , and let $\|x - a\| < \|a^{-1}\|^{-1}$, so that x is in U by Corollary 4.35. Then

$$\|x^{-1} - a^{-1}\| = \|x^{-1}(x - a)a^{-1}\| \leq \|a^{-1}\| \|x^{-1}\| \|x - a\|,$$

and continuity will follow if we show that $\|x^{-1}\| \leq M < \infty$ for x near a . Computation and Proposition 4.34 give

$$\|x^{-1}\| = \|(a - (a - x))^{-1}\| = \|a^{-1}(1 - (1 - xa^{-1}))^{-1}\| \leq \frac{\|a^{-1}\|}{1 - \|1 - xa^{-1}\|},$$

and the desired boundedness follows from continuity of multiplication. \square

Let \mathcal{A} be a complex Banach algebra with identity. If a is in \mathcal{A} , the **spectrum** of a is the set

$$\sigma(a) = \{\lambda \in \mathbb{C} \mid a - \lambda \text{ is not invertible}\}.$$

It will be proved in Corollary 4.39 below that $\sigma(a)$ is always nonempty. The **resolvent set** $P(a)$ of a is the complement of $\sigma(a)$ in \mathbb{C} . The **resolvent** of a is the function

$$R(\lambda) = (a - \lambda)^{-1} \quad \text{from } P(a) \text{ into } \mathcal{A}.$$

The **spectral radius** of a , denoted by $r(a)$, is

$$r(a) = \sup \{|\lambda| \mid \lambda \text{ is in } \sigma(a)\}.$$

Proposition 4.37. For a in a complex Banach algebra \mathcal{A} with identity, $\sigma(a)$ is compact and $r(a)$ is $\leq \|a\|$.

PROOF. The function $\lambda \mapsto a - \lambda$ is continuous, and the set U of invertible elements is open, the latter by Corollary 4.35. Thus $P(a) = \{\lambda \mid a - \lambda \text{ is in } U\}$ is open. Hence the complement $\sigma(a)$ is closed. Fix λ with $\lambda > \|a\|$. Then $\|\lambda^{-1}a\| < 1$, and therefore $\lambda^{-1}a - 1$ is in U . Since $\lambda \neq 0$, $a - \lambda$ is in U . Thus λ is in $P(a)$. It follows that $\sigma(a)$ is contained in $\{\lambda \mid |\lambda| \leq \|a\|\}$ and that $r(a) \leq \|a\|$. Since $\sigma(a)$ is then bounded, as well as closed, $\sigma(a)$ is compact. \square

We say that a function φ from an open subset V of \mathbb{C} into the complex Banach algebra \mathcal{A} is **weakly analytic** on V if $\ell \circ \varphi$ is an analytic function on V for every ℓ in the dual space \mathcal{A}^* .

Theorem 4.38. If \mathcal{A} is a complex Banach algebra with identity and if a is in \mathcal{A} , then $R(\lambda) = (a - \lambda)^{-1}$ is weakly analytic on $P(a)$ with $\lim_{\lambda \rightarrow \infty} \|R(\lambda)\| = 0$.

PROOF. Let λ_0 be in $P(a)$, and let ℓ be in \mathcal{A}^* . Writing

$$a - \lambda = (a - \lambda_0)(1 - (a - \lambda_0)^{-1}(\lambda - \lambda_0))$$

and applying Proposition 4.34, we see that $a - \lambda$ is invertible if the condition $\|(a - \lambda_0)^{-1}(\lambda - \lambda_0)\| < 1$ is satisfied. In this case,

$$(a - \lambda)^{-1} = (a - \lambda_0)^{-1} \sum_{n=0}^{\infty} (a - \lambda_0)^{-n} (\lambda - \lambda_0)^n,$$

and the continuity of ℓ yields

$$\ell((a - \lambda)^{-1}) = \sum_{n=0}^{\infty} \ell((a - \lambda_0)^{-n-1})(\lambda - \lambda_0)^n,$$

with the series convergent. Therefore $R(\lambda)$ is weakly analytic.

To establish that $\lim_{\lambda \rightarrow \infty} \|(a - \lambda)^{-1}\| = 0$, we write

$$(a - \lambda)^{-1} = (\lambda(\lambda^{-1}a - 1))^{-1} = \lambda^{-1}(\lambda^{-1}a - 1)^{-1}.$$

Proposition 4.34 gives

$$\|(\lambda^{-1}a - 1)^{-1}\| \leq (1 - |\lambda|^{-1}\|a\|)^{-1},$$

and the right side tends to 1 as λ tends to infinity. Hence $\lim_{\lambda \rightarrow \infty} \|(a - \lambda)^{-1}\| = 0$. \square

Corollary 4.39. If \mathcal{A} is a complex Banach algebra with identity, then $\sigma(a)$ is nonempty for each a in \mathcal{A} .

PROOF. If $\sigma(a)$ were to be empty, then every ℓ in \mathcal{A}^* would have $\lambda \mapsto \ell((a - \lambda)^{-1})$ entire and vanishing at infinity, by Theorem 4.38. By Liouville's Theorem, we would have $\ell((a - \lambda)^{-1}) = 0$ for every a and λ . Since ℓ is arbitrary, the Hahn–Banach Theorem would give $(a - \lambda)^{-1} = 0$, contradiction. \square

Corollary 4.40 (Gelfand–Mazur Theorem). The only complex Banach algebra with identity in which every nonzero element is invertible is \mathbb{C} itself.

PROOF. Suppose that \mathcal{A} is a complex Banach algebra with identity with every nonzero element invertible. If a is given in \mathcal{A} , $\sigma(a)$ is not empty, according to Corollary 4.39. Choose λ in $\sigma(a)$. Then $a - \lambda$ is not invertible. Since every nonzero element of \mathcal{A} is by assumption invertible, $a - \lambda = 0$. Hence $a = \lambda$. Thus \mathcal{A} consists of the scalar multiples of the identity. \square

Corollary 4.41. If \mathcal{A} is a commutative complex Banach algebra with identity, then the nonzero multiplicative linear functionals on \mathcal{A} stand in one-one correspondence with the maximal ideals of \mathcal{A} , the correspondence being

$$\ell = \left\{ \begin{array}{l} \text{multiplicative} \\ \text{linear functional} \end{array} \right\} \longrightarrow \ker \ell = \text{maximal ideal}$$

with inverse

$$I = \left\{ \begin{array}{l} \text{maximal ideal,} \\ \text{necessarily with} \\ \mathcal{A} = I \oplus \mathbb{C}1 \end{array} \right\} \longrightarrow \ell \text{ defined by } \ell(x, \lambda) = \lambda.$$

Every nonzero multiplicative linear functional is continuous with norm ≤ 1 , and every maximal ideal is closed. Every nonzero multiplicative linear functional carries 1 into 1.

REMARKS. The proof will make use of Problem 4 in Chapter XII of *Basic*: if X is a Banach space and Y is a closed subspace, then the vector space X/Y becomes a normed linear space under the definition $\|x + Y\| = \inf_{y \in Y} \|x + y\|$, and the resulting metric on X/Y is complete. Problem 1 at the end of the present chapter points out that the Banach space X/Y obtained this way has the same topology as the quotient topological vector space X/Y defined in Section 1.

PROOF. We may assume $\mathcal{A} \neq 0$. If ℓ is a nonzero multiplicative linear functional, then its kernel is an ideal of codimension 1, hence is a maximal ideal. Conversely if I is a maximal ideal, then no element of I can be invertible. Since the set U of invertible elements is open, according to Corollary 4.35, the set I is at positive distance from 1. Thus the closure I^{cl} , which is an ideal, does not contain 1. Since I is maximal, $I^{\text{cl}} = I$. Thus I is closed. By the above remarks, \mathcal{A}/I is a complex Banach space. Its multiplication makes it into a complex Banach algebra because if we take the infimum over $y_1 \in I$ and $y_2 \in I$ of the right side of the inequality

$$\begin{aligned} \|a_1 a_2 + I\| &\leq \|a_1 a_2 + (y_1 a_2 + a_1 y_2 + y_1 y_2)\| \\ &= \|(a_1 + y_1)(a_2 + y_2)\| \\ &\leq \|a_1 + y_1\| \|a_2 + y_2\|, \end{aligned}$$

we obtain $\|a_1 a_2 + I\| \leq \|a_1 + I\| \|a_2 + I\|$. The quotient \mathcal{A}/I is also a field, being the quotient of a nonzero commutative ring with identity by a maximal ideal. By Corollary 4.40, $\mathcal{A}/I \cong \mathbb{C}$. Hence I has codimension 1, and $\mathcal{A} = I \oplus \mathbb{C}1$ as vector spaces. If we define a linear functional ℓ by $\ell(x, \lambda) = \lambda$, then we readily check that ℓ is multiplicative and has kernel I . To see that ℓ is continuous, one way to proceed is to use the Hahn–Banach Theorem: Since I is closed and 1 is not in I ,

there exists a continuous linear functional ℓ' with $\ell'(1) \neq 0$ and $\ell'(I) = 0$. Then $\ell = \ell'(1)^{-1}\ell(1)\ell'$, and therefore ℓ is continuous.

This establishes the correspondence. To check that it is one-one, it is enough to see that any nonzero multiplicative linear functional carries 1 into 1. If ℓ is a nonzero multiplicative linear functional, then $\ell(a) = \ell(a)\ell(1) = \ell(a)\ell(1)$. If we choose a with $\ell(a) \neq 0$, then we can divide and conclude that $\ell(1) = 1$.

Finally we check the norm of the nonzero multiplicative linear functional ℓ . If a in \mathcal{A} has $\|a\| \leq 1$, then $|\ell(a)|^n = |\ell(a^n)| \leq \|\ell\|\|a^n\| \leq \|\ell\|\|a\|^n \leq \|\ell\|$. Since $n \geq 1$ is arbitrary, we must have $|\ell(a)| \leq 1$. Taking the supremum over a , we obtain $\|\ell\| \leq 1$. \square

If \mathcal{A} is a commutative complex Banach algebra with identity, we denote its space of maximal ideals by \mathcal{A}_m^* . For $\mathcal{A} \neq 0$, this space is nonempty by an application of Zorn's Lemma to the set of all proper ideals of \mathcal{A} . Using the identification via Corollary 4.41 of \mathcal{A}_m^* as a set of linear functionals of norm ≤ 1 , we can regard \mathcal{A}_m^* as a subset of the unit ball of the dual \mathcal{A}^* . We give \mathcal{A}_m^* the relative topology from the weak-star topology on \mathcal{A}^* .

Proposition 4.42. If \mathcal{A} is a commutative complex Banach algebra with identity, then the weak-star topology makes the maximal ideal space \mathcal{A}_m^* into a compact Hausdorff space.

PROOF. Corollary 4.41 identifies \mathcal{A}_m^* with a subset of the unit ball of \mathcal{A}^* , which is compact in the weak-star topology by Alaoglu's Theorem (Theorem 4.14) and is also Hausdorff. All we have to do is show that \mathcal{A}_m^* is a closed subset. For each a and b in \mathcal{A} , the set $\{\ell \in \mathcal{A}^* \mid \ell(ab) = \ell(a)\ell(b)\}$ is closed since the functions $\ell \mapsto \ell(ab)$ and $\ell \mapsto \ell(a)\ell(b)$ are continuous from the weak-star topology into \mathbb{C} . Hence the intersection over all a and b is closed. The set \mathcal{A}_m^* is the intersection of this set with the closed set $\{\ell \in \mathcal{A}^* \mid \ell(1) = 1\}$ and is therefore closed. \square

For L^1 or any other complex Banach algebra \mathcal{A} not containing an identity, the prescription for applying the above theory to \mathcal{A} is to adjoin an identity and form $\mathcal{A} \oplus \mathbb{C}$, apply the results to $\mathcal{A} \oplus \mathbb{C}$, and then see what happens when the identity is removed. For Proposition 4.42, \mathcal{A} is one of the maximal ideals in $\mathcal{A} \oplus \mathbb{C}$. Removing it from $(\mathcal{A} \oplus \mathbb{C})_m^*$ yields a locally compact Hausdorff space whose one-point compactification is $(\mathcal{A} \oplus \mathbb{C})_m^*$.

It is now just a formality to obtain a mapping of any commutative complex Banach algebra \mathcal{A} with identity into $C(\mathcal{A}_m^*)$. The **Gelfand transform** $a \mapsto \hat{a}$ is the mapping of \mathcal{A} into $C(\mathcal{A}_m^*)$ given by $\hat{a}(\ell) = \ell(a)$ for each nonzero multiplicative linear functional ℓ on \mathcal{A} .

In the context of a suitable subalgebra of $B(S)$, the Gelfand transform is just the evaluation of all nonzero multiplicative linear functionals on the members of

the subalgebra. Such linear functionals turn out automatically to respect complex conjugation.²¹ The evaluations at the points of S are a dense subset of these. The Stone Representation Theorem says that the Gelfand transform is a norm-preserving algebra isomorphism.

In the context of $L^1(\mathbb{R}^N)$, the Gelfand transform is just the Fourier transform. The nonzero multiplicative linear functionals are the functions $\ell_y(f) = \int_{\mathbb{R}^N} f(x)e^{-2\pi i x \cdot y} dx$ for $y \in \mathbb{R}^N$, i.e., $\ell_y(f) = \widehat{f}(y)$. The Gelfand transform is the mapping of f to the resulting function of ℓ_y or of y . It is therefore exactly the Fourier transform $f \mapsto \widehat{f}$ if we parametrize $L^1(\mathbb{R}^N)_m^*$ by the variable y .

The Gelfand transform makes sense for our other two examples as well, for L^∞ and for the complex Banach algebra generated by the identity and a single self-adjoint bounded linear operator on a Hilbert space. But we do not so far get much insight into what the Gelfand transform does for these cases. We can summarize all the formalism as follows.

Proposition 4.43. If \mathcal{A} is a commutative complex Banach algebra with identity, then the Gelfand transform is an algebra homomorphism of norm ≤ 1 of \mathcal{A} into $C(\mathcal{A}_m^*)$ carrying 1 to 1, and its kernel is the intersection of all maximal ideals of \mathcal{A} . Moreover, for each a and b in \mathcal{A} ,

- (a) $\sigma(a)$ is the image of the function \widehat{a} in \mathbb{C} ,
- (b) $r(a) = \|\widehat{a}\|_{\text{sup}}$,
- (c) $r(a + b) \leq r(a) + r(b)$ and $r(ab) \leq r(a)r(b)$.

PROOF. The Gelfand transform is an algebra homomorphism because

$$\widehat{ab}(\ell) = \ell(ab) = \ell(a)\ell(b) = \widehat{a}(\ell)\widehat{b}(\ell)$$

for all ℓ in \mathcal{A}_m^* . Corollary 4.41 shows that each ℓ in \mathcal{A}_m^* has norm ≤ 1 , and therefore $|\widehat{a}(\ell)| = |\ell(a)| \leq \|a\|$. Hence $\|\widehat{a}\|_{\text{sup}} \leq \|a\|$, and the Gelfand transform has norm ≤ 1 . Corollary 4.41 shows that every nonzero multiplicative linear functional carries 1 into 1, and therefore the Gelfand transform carries 1 into 1.

The kernel of the Gelfand transform is the set of all a in \mathcal{A} with $\widehat{a}(\ell) = 0$ for all ℓ , thus the set of all a with $\ell(a) = 0$ for all ℓ , thus the intersection of the kernels of all ℓ 's.

For (a), we observe that a is invertible if and only if $a\mathcal{A} = \mathcal{A}$, if and only if a is not in any maximal ideal, if and only if \widehat{a} is nowhere vanishing. Thus a complex number λ is in $\sigma(a)$ if and only if $a - \lambda$ is not invertible, if and only if $\widehat{a} - \lambda$ is somewhere vanishing, if and only if λ is in the image of \widehat{a} . This proves (a).

²¹The verification for an algebra as in Theorem 4.15 that the nonzero multiplicative linear functionals automatically respect complex conjugation is embedded in the proof of Theorem 4.48 below. See the paragraph of the proof containing the display (†) and the two paragraphs that follow it.

Conclusion (b) is immediate from (a) and the definition of $r(a)$, and (c) follows from (b) and the inequalities satisfied by the supremum norm. This completes the proof. \square

Proposition 4.43 isolates the real problem, which is to say something quantitative about the intersection of the kernels of all maximal ideals, about $\sigma(a)$, and about $r(a)$. For our purposes it will be enough to have the spectral radius formula that is proved in Corollary 4.46 below.

Theorem 4.44 (Spectral Mapping Theorem). If \mathcal{A} is a complex Banach algebra with identity, if a is in \mathcal{A} , and if Q is any polynomial in one variable, then $Q(\sigma(a)) = \sigma(Q(a))$.

REMARKS. The left side $Q(\sigma(a))$ is understood to be the image under Q of the set $\sigma(a)$, while the right side $\sigma(Q(a))$ is the spectrum of $Q(a)$, i.e., the spectrum of the member of \mathcal{A} obtained by substituting a for the variable in Q .

PROOF. First we show that $Q(\sigma(a)) \subseteq \sigma(Q(a))$. Let λ_0 be in $\sigma(a)$, so that $a - \lambda_0$ is not invertible. Arguing by contradiction, suppose that $Q(a) - Q(\lambda_0)$ is invertible, say with b as two-sided inverse. Let S be the polynomial defined by $Q(\lambda) - Q(\lambda_0) = (\lambda - \lambda_0)S(\lambda)$. Since b is a two-sided inverse of $Q(a) - Q(\lambda_0) = (a - \lambda_0)S(a)$, we have $1 = b(a - \lambda_0)S(a) = (bS(a))(a - \lambda_0)$ and $1 = (a - \lambda_0)(S(a)b)$. Thus $a - \lambda_0$ has a left inverse $bS(a)$ and a right inverse $S(a)b$, and $a - \lambda_0$ must be invertible, contradiction.

For the reverse inclusion $\sigma(Q(a)) \subseteq Q(\sigma(a))$, suppose that λ_0 is in $\sigma(Q(a))$. Let $\lambda_1, \dots, \lambda_n$ be the roots of $Q(\lambda) - \lambda_0$ repeated according to their multiplicities. Then we have $Q(\lambda) - \lambda_0 = c(\lambda - \lambda_1) \cdots (\lambda - \lambda_n)$ for some nonzero constant c . Substitution of a for λ gives

$$Q(a) - \lambda_0 = c(a - \lambda_1) \cdots (a - \lambda_n).$$

Since $Q(a) - \lambda_0$ is by assumption not invertible, some $a - \lambda_j$ is not invertible. For this j , λ_j is in $\sigma(a)$. Since λ_j is a root of $Q(\lambda) - \lambda_0$, we have $Q(\lambda_j) - \lambda_0 = 0$, i.e., $Q(\lambda_j) = \lambda_0$. Hence λ_0 is exhibited as Q of the member λ_j of $\sigma(a)$. \square

Corollary 4.45. If \mathcal{A} is a complex Banach algebra with identity and if a is in \mathcal{A} , then $r(a^n) = r(a)^n$ for every integer $n \geq 1$.

PROOF. This follows by taking $Q(\lambda) = \lambda^n$ in Theorem 4.44 and then using the definition of the function r . \square

Corollary 4.46 (spectral radius formula). If \mathcal{A} is a complex Banach algebra with identity and if a is in \mathcal{A} , then

$$r(a) = \lim_{n \rightarrow \infty} \|a^n\|^{1/n},$$

the limit existing.

PROOF. For every n , Corollary 4.45 and Proposition 4.37 give $r(a)^n = r(a^n) \leq \|a^n\|$ and thus $r(a) \leq \|a^n\|^{1/n}$. Hence

$$r(a) \leq \liminf_n \|a^n\|^{1/n}. \quad (*)$$

If $|\lambda| < \|a\|^{-1}$ and ℓ is in the dual space \mathcal{A}^* , then Proposition 4.34 yields

$$(1 - \lambda a)^{-1} = \sum_{n=0}^{\infty} a^n \lambda^n \quad \text{and therefore} \quad \ell((1 - \lambda a)^{-1}) = \sum_{n=0}^{\infty} \ell(a^n) \lambda^n.$$

Theorem 4.38 shows that $\lambda \mapsto \ell((1 - \lambda a)^{-1})$ is analytic for λ^{-1} in $P(a)$, and Proposition 4.37 shows that this analyticity occurs for $|\lambda|^{-1} > r(a)$, hence for $|\lambda| < r(a)^{-1}$. Therefore the power series $\sum_{n=0}^{\infty} \ell(a^n) \lambda^n$ is convergent for $|\lambda| < r(a)^{-1}$. Since the terms of a convergent series are bounded, each fixed λ within the disk of convergence must have $|\ell(a^n)| |\lambda^n| \leq M_\ell$ for some constant M_ℓ . That is,

$$|\ell(\lambda^n a^n)| \leq M_\ell \quad (**)$$

for all n . Each linear functional on \mathcal{A}^* given by $\ell \mapsto \ell(\lambda^n a^n)$ is bounded, and therefore the system of such linear functionals as n varies, which has been shown in (**) to be pointwise bounded, satisfies $\|\lambda^n a^n\| \leq M$ by the Uniform Boundedness Theorem. Consequently $|\lambda| \|a^n\|^{1/n} \leq M^{1/n}$. Taking the limsup of both sides gives $|\lambda| \limsup_n \|a^n\|^{1/n} \leq 1$, and hence $\limsup_n \|a^n\|^{1/n} \leq |\lambda|^{-1}$. Since λ is an arbitrary complex number with $|\lambda|^{-1} > r(a)$, we obtain $\limsup_n \|a^n\|^{1/n} \leq r(a)$. In combination with (*), this inequality completes the proof. \square

The spectral radius formula gives us the following quantitative conclusion about the Gelfand transform.

Corollary 4.47. The Gelfand transform for a commutative complex Banach algebra \mathcal{A} with identity is norm preserving from \mathcal{A} to $C(\mathcal{A}_m^*)$ if and only if $\|a^2\| = \|a\|^2$ for all a in \mathcal{A} .

PROOF. If $\|a^2\| = \|a\|^2$ for all a , then induction gives $\|a^{2^n}\| = \|a\|^{2^n}$ and thus $\|a\| = \|a^{2^n}\|^{2^{-n}}$. Hence $\|a\| = \lim_n \|a^{2^n}\|^{2^{-n}}$. This limit equals $r(a)$ by the spectral radius formula (Corollary 4.46), and $r(a)$ equals $\|\widehat{a}\|_{\text{sup}}$ by Proposition 4.43b. Therefore $\|a\| = \|\widehat{a}\|_{\text{sup}}$.

Conversely if $\|\widehat{a}\|_{\text{sup}} = \|a\|$ for all a , then $r(a) = \|a\|$ by Proposition 4.43b, and $\|a^2\| = r(a^2) = r(a)^2 = \|a\|^2$ by Corollary 4.45. \square

This represents some progress. The condition $\|a^2\| = \|a\|^2$ is satisfied in L^∞ , and hence the Gelfand transform is a norm-preserving algebra homomorphism of L^∞ into $C(\mathcal{A}_m^*)$. In L^1 after an identity is adjoined, the condition $\|a^2\| = \|a\|^2$

is not universally satisfied, and the corollary says that the Gelfand transform, i.e., the Fourier transform, is not norm preserving; this conclusion has content, but it is not a surprise. In the case of the complex Banach algebra generated by the identity and a bounded self-adjoint operator A , the condition $\|a^2\| = \|a\|^2$ is satisfied for $a = A$ as a consequence of Proposition 2.2 with $L = A^*A$, but it is less transparent what happens with other operators in the Banach algebra that are not self adjoint.

The final step is to bring the operation $(\cdot)^*$ into play. An **involution** of a complex Banach algebra \mathcal{A} is a map $a \mapsto a^*$ of \mathcal{A} into itself with the properties that the following hold for all a and b in \mathcal{A} :

- (i) $a^{**} = a$,
- (ii) $(a + b)^* = a^* + b^*$,
- (iii) $(\lambda a)^* = \bar{\lambda}a^*$ for all λ in \mathbb{C} ,
- (iv) $(ab)^* = b^*a^*$.

A complex Banach algebra \mathcal{A} with involution $(\cdot)^*$ is called a C^* **algebra** if

- (v) $\|a^*a\| = \|a\|^2$ for all a in \mathcal{A} .

Our examples— $B(S)$ and certain subalgebras, L^∞ , L^1 , and $\mathcal{B}(H, H)$ are all complex Banach algebras with involution. For $B(S)$ and L^∞ , the involution is complex conjugation. For L^1 , it is $f \mapsto g$ with $g(x) = \overline{f(-x)}$, and for $\mathcal{B}(H, H)$ it is adjoint. Of these examples all but L^1 are C^* algebras.

Observe that (i) and (iv) imply that the element 1, if it is present, has to satisfy $1^* = 1$ because $1 = (1^*)^* = (11^*)^* = 1^{**}1^* = 11^* = 1^*$. If (v) holds also, then (v) with $a = 1$ shows that $\|1\| = 1$.

Theorem 4.48. If \mathcal{A} is a commutative C^* algebra with identity, then the Gelfand transform is a norm-preserving algebra isomorphism of \mathcal{A} onto $C(\mathcal{A}_m^*)$, and it carries $(\cdot)^*$ into complex conjugation.

PROOF. For any a in \mathcal{A} , (v) gives $\|a\|^2 = \|a^*a\| \leq \|a^*\| \|a\|$. If $a = 0$, then $a^* = 0$; otherwise division by $\|a\|$ gives $\|a\| \leq \|a^*\|$. Applying this inequality to a^* and using (i), we obtain

$$\|a^*\| = \|a\|. \quad (*)$$

Next suppose that b is an element of \mathcal{A} with $b^* = b$. Raising to powers gives $(b^{2^n})^* = (b^{2^n})^*$ for $n \geq 0$. Then (v) gives $\|b^{2^n}\| = \|(b^{2^{n-1}})^*b^{2^{n-1}}\| = \|b^{2^{n-1}}\|^2$, and induction shows that $\|b^{2^n}\| = \|b\|^{2^n}$. Hence $\|b\| = \|b^{2^n}\|^{2^{-n}}$. Taking the limit and applying the spectral radius formula and Proposition 4.43b, we obtain

$$\|b\| = \lim_n \|b^{2^n}\|^{2^{-n}} = r(b) = \|\widehat{b}\|_{\text{sup}}. \quad (**)$$

The Gelfand transform is an algebra homomorphism by Proposition 4.43. If a general a is given in \mathcal{A} , then we can apply $(*)$ to a and $(**)$ to $b = a^*a$ to obtain

$$\begin{aligned} \|a^*\| \|a\| &= \|a\|^2 = \|a^*a\| = \|b\| = \|\widehat{b}\|_{\text{sup}} = \|\widehat{a^*a}\|_{\text{sup}} \\ &= \|\widehat{a^*}\widehat{a}\|_{\text{sup}} \leq \|\widehat{a^*}\|_{\text{sup}} \|\widehat{a}\|_{\text{sup}} \leq \|a^*\| \|a\|, \end{aligned}$$

the last inequality holding since the Gelfand transform has norm ≤ 1 according to Proposition 4.43. The end expressions are equal, and equality must hold throughout. Therefore $\|\widehat{a}\|_{\text{sup}} = \|a\|$, and the Gelfand transform is norm preserving.

In working toward proving that the Gelfand transform carries $(\cdot)^*$ into complex conjugation, we first show that

$$b^* = b \quad \text{implies} \quad i \text{ is not in } \sigma(b). \quad (\dagger)$$

Assuming the contrary, we find that 1 is in $\sigma(-ib)$. By the Spectral Mapping Theorem (Theorem 4.44), $\lambda + 1$ is in $\sigma(\lambda - ib)$ for all real λ . Hence

$$\begin{aligned} (\lambda + 1)^2 &\leq (r(\lambda - ib))^2 \leq \|\lambda - ib\|^2 = \|(\lambda - ib)^*(\lambda - ib)\| \\ &= \|(\lambda + ib)(\lambda - ib)\| = \|\lambda^2 + b^2\| \leq \lambda^2 \|1\| + \|b^2\| = \lambda^2 + \|b^2\|, \end{aligned}$$

and $2\lambda + 1 \leq \|b\|^2$ for all real λ . This is a contradiction, and (\dagger) is proved.

Next let us deduce from (\dagger) that

$$b^* = b \quad \text{implies} \quad \sigma(b) \subseteq \mathbb{R}. \quad (\dagger\dagger)$$

Suppose that $\lambda = \alpha + i\beta$ has α and β real and $\beta \neq 0$. Then $\beta^{-1}(b - \lambda) = \beta^{-1}(b - \alpha) - i$. The element $\beta^{-1}(b - \lambda)$ has $(\beta^{-1}(b - \lambda))^* = \beta^{-1}(b - \alpha)$, and (\dagger) shows that i is not in its spectrum. Therefore $\beta^{-1}(b - \lambda) = \beta^{-1}(b - \alpha) - i$ is invertible. Since $\beta \neq 0$, $b - \lambda$ is invertible. Therefore λ is not in $\sigma(b)$. This proves $(\dagger\dagger)$.

Now we shall show that the Gelfand transform carries $(\cdot)^*$ into complex conjugation. Let a be in \mathcal{A} , and write $a = \frac{1}{2}(a + a^*) + \frac{1}{2i}((ia) + (ia)^*) = b + ic$ with $b^* = b$ and $c^* = c$. Then $a^* = b - ic$. From $(\dagger\dagger)$ we know that \widehat{b} and \widehat{c} are real-valued. Therefore $\widehat{a^*}(\ell) = \widehat{b}(\ell) - i\widehat{c}(\ell) = \overline{\widehat{b}(\ell) + i\widehat{c}(\ell)} = \overline{\widehat{a}(\ell)}$, as asserted.

Since the Gelfand transform is norm preserving, respects products, and carries 1 into 1 , its image is a uniformly closed subalgebra of $C(\mathcal{A}_m^*)$. The fact that $(\cdot)^*$ is carried into complex conjugation implies that the image is closed under complex conjugation. The image separates points of \mathcal{A} by definition of equality of linear functionals. By the Stone–Weierstrass Theorem the image is all of $C(\mathcal{A}_m^*)$. This completes the proof. \square

Among our examples, if \mathcal{A} is a conjugate-closed Banach subalgebra of $B(S)$ with identity, then Theorem 4.48 reproduces the Stone Representation Theorem (Theorem 4.15).

Second if \mathcal{A} is L^∞ , Theorem 4.48 gives us something new, identifying L^∞ with $C((L^\infty)_m^*)$. We do not get a total understanding of $(L^\infty)_m^*$, but we do get some understanding from the fact that every ideal is contained in a maximal ideal. We can produce an ideal in L^∞ merely by specifying a measurable subset; the ideal consists of all essentially bounded functions, modulo null functions, that vanish on that set. As the set gets smaller, we get closer to the situation of a maximal ideal.

Third if \mathcal{A} is L^1 , Theorem 4.48 gives us no information since L^1 is not a C^* algebra. The theory of complex Banach algebras can be pursued in a direction that specializes to more information about L^1 , but we shall not follow such a route.

Fourth if \mathcal{A} is the complex Banach algebra generated by the identity and a bounded self-adjoint operator A on a Hilbert space H , then Theorem 4.48 is applicable and realizes the algebra as $C(\mathcal{A}_m^*)$. We shall see in the next section that \mathcal{A}_m^* can be viewed as the spectrum $\sigma(A)$. However, the Hilbert space H plays no role in this realization, and we therefore cannot expect to learn much about our original operator from $C(\mathcal{A}_m^*)$. For example we cannot distinguish between the two operators on \mathbb{C}^3 given by diagonal matrices $\text{diag}(1, 1, 2)$ and $\text{diag}(1, 2, 2)$ on the basis of the spectrum of each. The goal of the next section is to remedy this defect.

Since we shall want to consider operators in $\mathcal{B}(H, H)$ as belonging to more than one C^* algebra, let us take another look at the definition of the spectrum of an element. The spectrum of a , as a member of \mathcal{A} , is the set of complex λ for which $(a - \lambda)^{-1}$ fails to exist as a member of \mathcal{A} . Certainly if we have $\mathcal{A}_1 \subseteq \mathcal{A}_2$ and a is in \mathcal{A}_1 , then the failure of $(a - \lambda)^{-1}$ to exist in \mathcal{A}_2 implies the failure of $(a - \lambda)^{-1}$ to exist in \mathcal{A}_1 . Hence the spectrum relative to \mathcal{A}_1 contains the spectrum relative to \mathcal{A}_2 . The spectrum is the smallest for $\mathcal{A} = \mathcal{B}(H, H)$. The following corollary implies that for operators A with $AA^* = A^*A$, the smallest possible spectrum is already achieved for the C^* algebra generated by 1, A , and A^* .

Corollary 4.49. If \mathcal{A} is a C^* algebra with identity and if a is an invertible element of \mathcal{A} such that $aa^* = a^*a$, then a is invertible already in the smallest closed subalgebra \mathcal{A}_0 of \mathcal{A} containing 1, a , and a^* .

PROOF. Since $a^{-1}a^* = a^{-1}(a^*a)a^{-1} = a^{-1}(aa^*)a^{-1} = a^*a^{-1}$, the smallest closed subalgebra \mathcal{A}_1 of \mathcal{A} containing 1, a , a^* , a^{-1} , and a^{-1*} is commutative, hence is a commutative C^* algebra with identity. Form the Gelfand transform $b \mapsto \widehat{b}$ for \mathcal{A}_1 . Then \widehat{a} and $\widehat{a^{-1}}$ are reciprocals, and the image of \widehat{a} is therefore bounded away from 0. By the Stone–Weierstrass Theorem we can find a sequence

$\{p_n(z, \bar{z})\}$ of polynomial functions that converge uniformly on the compact image of \widehat{a} to $1/z$. Since by Theorem 4.48, the Gelfand transform is isometric for \mathcal{A}_1 , we have $a^{-1} = \lim p_n(a, a^*)$ in \mathcal{A}_1 , and a^{-1} is therefore exhibited as a member of \mathcal{A}_0 . \square

11. Spectral Theorem for Bounded Self-Adjoint Operators

The goal of this section is to expand upon Theorem 4.48 in the case of a commutative C^* algebra of bounded linear operators on a Hilbert space in such a way that the Hilbert space plays a decisive role. The result will be the Spectral Theorem, and we shall see how the Spectral Theorem enables one to compute with the operators in question. The theorem to be given here is limited to the case of a separable Hilbert space, and the assumption of separability will be included in all our results about general spaces $\mathcal{B}(H, H)$. The Spectral Theorem will enable us to view the operators in question as multiplications by L^∞ functions on an L^2 space, and we therefore begin with that example.

EXAMPLE. Let (S, μ) be a finite measure space, and let H be the Hilbert space $H = L^2(S, \mu)$. For f in $L^\infty(S, \mu)$, define $M_f : L^2 \rightarrow L^2$ by $M_f(g) = fg$. The computation

$$\|M_f(g)\|_2^2 = \int_X |fg|^2 d\mu \leq \|f\|_\infty^2 \int_X |g|^2 d\mu = \|f\|_\infty^2 \|g\|_2^2$$

shows that M_f is a bounded operator on H with $\|M_f\| \leq \|f\|_\infty$. Shortly we shall check that equality holds:

$$\|M_f\| = \|f\|_\infty. \quad (*)$$

But first, let us observe that

$$M_{fg} = M_f M_g, \quad M_{\alpha f + \beta g} = \alpha M_f + \beta M_g, \quad M_f^* = M_{\bar{f}}, \quad M_1 = I.$$

These facts, in combination with (*), say that $f \mapsto M_f$ is a norm-preserving C^* algebra isomorphism of the commutative C^* algebra $L^\infty(S, \mu)$ onto the subalgebra

$$\mathcal{M}(L^2(S, \mu)) = \{M_f \in \mathcal{B}(L^2(S, \mu), L^2(S, \mu)) \mid f \in L^\infty(S, \mu)\}$$

of the C^* algebra $\mathcal{B}(L^2(S, \mu), L^2(S, \mu))$. The algebra $\mathcal{M}(L^2(S, \mu))$ is called the **multiplication algebra** on $L^2(S, \mu)$. Returning to the verification of (*), let $\epsilon > 0$ be given with $\epsilon \leq \|f\|_\infty$, and let

$$E = \{x \mid |f(x)| \geq \|f\|_\infty - \epsilon\}.$$

Then $0 < \mu(E) < \infty$, and we take g to be the function that is 1 on E and is 0 on E^c . Then $\|g\|_2 = \mu(E)^{1/2}$, and

$$\|fg\|_2^2 = \int_X |fg|^2 d\mu = \int_E |f|^2 d\mu \geq (\|f\|_\infty - \epsilon)^2 \mu(E).$$

Therefore

$$(\|f\|_\infty - \epsilon)\mu(E)^{1/2} \leq \|M_f g\|_2 \leq \|M_f\| \|g\|_2 = \|M_f\| \mu(E)^{1/2},$$

and $\|f\|_\infty - \epsilon \leq \|M_f\|$. Since we already know that $\|M_f\| \leq \|f\|_\infty$ and since ϵ is arbitrary, we conclude that (*) holds.

Now let us consider an arbitrary bounded self-adjoint linear operator on a separable Hilbert space. We mentioned at the end of Section 10 the two operators on \mathbb{C}^3 given by diagonal matrices $\text{diag}(1, 1, 2)$ and $\text{diag}(1, 2, 2)$. The C^* algebras generated by these operators are isomorphic 2-dimensional algebras, and hence there is no way to superimpose on the setting of Theorem 4.48 the action of the operators on the Hilbert space \mathbb{C}^3 if we consider these operators by themselves. The operators do get distinguished, however, if we enlarge the C^* algebra under consideration, working instead with the 3-dimensional commutative C^* algebra of all diagonal matrices. In the general situation, as long as we are going to enlarge the algebra of operators under consideration, we may as well enlarge it as much as possible while keeping it commutative.

If H is a Hilbert space, a **maximal abelian self-adjoint subalgebra** in $\mathcal{B}(H, H)$ is a commutative C^* subalgebra of $\mathcal{B}(H, H)$ that is not contained in any larger commutative subalgebra of $\mathcal{B}(H, H)$ that is closed under $(\cdot)^*$. In the example with $H = \mathbb{C}^3$ in the previous paragraph, the 3-dimensional algebra of diagonal matrices is a maximal abelian self-adjoint subalgebra.

For general H , we shall obtain a simple criterion for a subalgebra to be maximal abelian self-adjoint, we shall show that the multiplication algebra for an L^2 space with respect to a finite measure meets this criterion, and then we shall see that maximal abelian self-adjoint subalgebras have a special property that will allow us to incorporate the Hilbert space into an application of Theorem 4.48.

If \mathcal{T} is a subset of $\mathcal{B}(H, H)$, let

$$\mathcal{T}' = \{A \in \mathcal{B}(H, H) \mid AB = BA \text{ for all } B \in \mathcal{T}\}.$$

The set \mathcal{T}' is a subalgebra of $\mathcal{B}(H, H)$ containing the identity and called the **commuting algebra** of \mathcal{T} . It has the following properties:

- (i) \mathcal{T}' is closed in the operator-norm topology,
- (ii) $\mathcal{T}' \supseteq \mathcal{T}$ if and only if \mathcal{T} is commutative,

- (iii) if \mathcal{T} is stable under $(\cdot)^*$, then \mathcal{T}' is stable under $(\cdot)^*$ and hence is a C^* subalgebra of $\mathcal{B}(H, H)$,
- (iv) a subalgebra \mathcal{A} of $\mathcal{B}(H, H)$ stable under $(\cdot)^*$ is a maximal abelian self-adjoint subalgebra of $\mathcal{B}(H, H)$ if and only if $\mathcal{A}' = \mathcal{A}$.

All of these properties are verified by inspection except possibly the assertion in (iv) that \mathcal{A} maximal implies that \mathcal{A}' does not strictly contain \mathcal{A} . For this assertion let \mathcal{A} be maximal, and suppose that B lies in \mathcal{A}' but not \mathcal{A} . Since \mathcal{A} is stable under $(\cdot)^*$, B^* lies in \mathcal{A}' , and so does $B + B^*$. Then $B + B^*$ and \mathcal{A} together generate a C^* subalgebra that is commutative and strictly contains \mathcal{A} , in contradiction to the maximality of \mathcal{A} . This proves (iv).

Proposition 4.50. If (S, μ) is a finite measure space, then the multiplication algebra on $L^2(S, \mu)$ is a maximal abelian self-adjoint subalgebra of the algebra $\mathcal{B}(L^2(S, \mu), L^2(S, \mu))$.

PROOF. Write \mathcal{M} for $\mathcal{M}(L^2(S, \mu))$. Since \mathcal{M} is commutative, (ii) shows that $\mathcal{M}' \supseteq \mathcal{M}$. Since \mathcal{M} is stable under $(\cdot)^*$, (iv) shows that it is enough to prove that $\mathcal{M}' \subseteq \mathcal{M}$. Thus let T be in \mathcal{M}' , and define an L^2 function g by $g = T(1)$. If f is in L^∞ , then the fact that T is in \mathcal{M}' implies that

$$Tf = TM_f(1) = M_fT(1) = M_fg = fg.$$

If the set where $N \leq |g(x)| \leq N + 1$ has positive measure, then an argument in the example with $L^2(S, \mu)$ shows that $\|T\| \geq N$. Since T is assumed bounded, we conclude that g is in L^∞ . Therefore $Tf = M_gf$ for all f in L^∞ . Since L^∞ is dense in L^2 for a finite measure space and since T and M_g are both bounded, $T = M_g$. Therefore T is exhibited as in \mathcal{M} , and the proof that $\mathcal{M}' \subseteq \mathcal{M}$ is complete. \square

We come now to the special property of maximal abelian self-adjoint subalgebras that will allow us to bring the Hilbert space into play when applying Theorem 4.48 to these subalgebras. If \mathcal{A} is any subalgebra of $\mathcal{B}(H, H)$, a vector x in H is called a **cyclic vector** for \mathcal{A} if the vector subspace $\mathcal{A}x$ of H is dense in H .

Lemma 4.51. Let H be a complex Hilbert space, let $K \subseteq H$ be a closed vector subspace, and let E be the orthogonal projection of H on K . If \mathcal{A} is a subalgebra of $\mathcal{B}(H, H)$ that is stable under $(\cdot)^*$ and has the property that $A(K) \subseteq K$ for all A in \mathcal{A} , then E is in \mathcal{A}' .

PROOF. Since $A(K) \subseteq K$, $AE(x)$ is in K for all x in H . Therefore $AE(x) = EAE(x)$ for all x in H , and $AE = EAE$. Since $E^* = E$ and since \mathcal{A} is stable under $(\cdot)^*$, $A^*E = EA^*E$. Consequently $EA = E^*A = (A^*E)^* = (EA^*E)^* = EAE = AE$, and E is in \mathcal{A}' . \square

Proposition 4.52. If H is a complex separable Hilbert space and \mathcal{A} is a maximal self-adjoint subalgebra of $\mathcal{B}(H, H)$, then \mathcal{A} has a cyclic vector.

REMARKS. The 2-dimensional subalgebras that we introduced in connection with \mathbb{C}^3 have no cyclic vectors, as we see by a count of dimensions; however, the full 3-dimensional diagonal subalgebra has $\begin{pmatrix} 1 \\ 1 \\ 1 \end{pmatrix}$ as a cyclic vector since

$$\begin{pmatrix} a & 0 & 0 \\ 0 & b & 0 \\ 0 & 0 & c \end{pmatrix} \begin{pmatrix} 1 \\ 1 \\ 1 \end{pmatrix} = \begin{pmatrix} a \\ b \\ c \end{pmatrix}.$$

PROOF. For each x in H , form the closed vector subspace $(\mathcal{A}x)^{\text{cl}}$. Since the identity is in \mathcal{A} , x is in $\mathcal{A}x$. Since $\mathcal{A}x$ is stable under \mathcal{A} and since the members of \mathcal{A} are bounded operators, $(\mathcal{A}x)^{\text{cl}}$ is stable under \mathcal{A} . The vector subspace $\mathcal{A}x$ has the property that

$$y \perp \mathcal{A}x \quad \text{implies} \quad \mathcal{A}y \perp \mathcal{A}x \quad (*)$$

because $(\mathcal{A}x, \mathcal{A}y) = (y, \mathcal{A}^* \mathcal{A}x) = 0$ if \mathcal{A} and \mathcal{B} are in \mathcal{A} . Consider orthonormal subsets $\{x_\alpha\}$ in H such that $\mathcal{A}x_\alpha \perp \mathcal{A}x_\beta$ for $\alpha \neq \beta$. Such sets exist, the empty set being one. By Zorn's Lemma let $S = \{x_\alpha\}$ be a maximal such set. This maximal S has the property that

$$H = \left(\sum_{x_\alpha \in S} \mathcal{A}x_\alpha \right)^{\text{cl}},$$

since otherwise we could obtain a contradiction by adjoining any unit vector in $\left(\left(\sum_{x_\alpha \in S} \mathcal{A}x_\alpha \right)^{\text{cl}} \right)^\perp$ to S and applying (*). Since H is separable, S is countable. Let us enumerate its members as x_1, x_2, \dots . Put $z = \sum_{n=1}^{\infty} 2^{-n} x_n$. This series converges in H since H is complete, and we shall prove that the sum z is a cyclic vector for \mathcal{A} .

Lemma 4.51 implies that the orthogonal projection E_n of H onto $(\mathcal{A}x_n)^{\text{cl}}$ is in \mathcal{A}' . Since \mathcal{A} is a maximal abelian self-adjoint subalgebra of $\mathcal{B}(H, H)$, $\mathcal{A}' = \mathcal{A}$. Hence E_n is in \mathcal{A} . Therefore $\mathcal{A}z \supseteq \mathcal{A}E_n z = \mathcal{A}2^{-n} x_n = \mathcal{A}x_n$ for all n , and we obtain $(\mathcal{A}z)^{\text{cl}} \supseteq \left(\sum_n \mathcal{A}x_n \right)^{\text{cl}} = H$. This completes the proof. \square

If H_1 and H_2 are complex Hilbert spaces, a **unitary operator** U from H_1 to H_2 is a linear operator from H_1 onto H_2 with $\|Ux\|_{H_2} = \|x\|_{H_1}$ for all x in H_1 . Such an operator is invertible, and its inverse is unitary. By means of polarization, one sees that a unitary operator satisfies also the identity $(Ux, Uy)_{H_2} = (x, y)_{H_1}$, i.e., that the inner product is preserved. Therefore a unitary operator provides the natural notion of isomorphism between two Hilbert spaces.

Theorem 4.53. If H is a nonzero complex separable Hilbert space and \mathcal{A} is a maximal abelian self-adjoint subalgebra of $\mathcal{B}(H, H)$, then there exists a measure space (S, μ) with $\mu(S) = 1$ and a unitary operator $U : H \rightarrow L^2(S, \mu)$ such that

$$U\mathcal{A}U^{-1} = \mathcal{M}(L^2(S, \mu)).$$

REMARK. In other words, under the assumption that H is separable, any maximal abelian self-adjoint subalgebra of $\mathcal{B}(H, H)$ is isomorphic to the multiplication algebra for the L^2 space relative to some finite measure.

PROOF. Applying Proposition 4.52, let z be a unit cyclic vector for \mathcal{A} . Let us see that the linear map of \mathcal{A} into H given by $A \mapsto Az$ is one-one. In fact, if $Az = 0$, then every B in \mathcal{A} has $A(Bz) = BAz = B0 = 0$. Since $\mathcal{A}z$ is dense in H and A is bounded, A is 0.

We saw before Proposition 4.50 that \mathcal{A} is a commutative C^* algebra with identity. By Theorem 4.48 the Gelfand transform $A \mapsto \widehat{A}$ is a norm-preserving algebra isomorphism of \mathcal{A} onto $C(\mathcal{A}_m^*)$ carrying $(\cdot)^*$ to complex conjugation. Define a linear functional ℓ on $C(\mathcal{A}_m^*)$ by

$$\ell(\widehat{A}) = (Az, z)_H,$$

the inner product being the inner product in H . Let us see that the linear functional ℓ is positive. In fact, any function ≥ 0 in $C(\mathcal{A}_m^*)$ is the absolute value squared of some element of $C(\mathcal{A}_m^*)$, hence is of the form $|\widehat{A}|^2$. Then

$$\ell(|\widehat{A}|^2) = \ell(\overline{\widehat{A}}\widehat{A}) = \ell(\widehat{A^*A}) = (A^*Az, z)_H = (Az, Az)_H \geq 0.$$

By the Riesz Representation Theorem, there exists a unique regular Borel measure μ on \mathcal{A}_m^* such that

$$\ell(\widehat{A}) = \int_{\mathcal{A}_m^*} \widehat{A} d\mu$$

for all \widehat{A} in $C(\mathcal{A}_m^*)$. The measure μ has total mass equal to $\ell(1) = \ell(\widehat{I}) = (Iz, z)_H = \|z\|_H^2 = 1$.

We shall now construct the unitary operator U carrying H to $L^2(\mathcal{A}_m^*, \mu)$. On the dense vector subspace $\mathcal{A}z$ of H , define a linear mapping U_0 by

$$U_0Az = \widehat{A} \in C(\mathcal{A}_m^*) \subseteq L^2(\mathcal{A}_m^*, \mu).$$

This is well defined since, as we have seen, $Az = 0$ implies $A = 0$. On the vector subspace $\mathcal{A}z$, we have

$$\|U_0Az\|_{L^2(\mathcal{A}_m^*)}^2 = \int_{\mathcal{A}_m^*} |\widehat{A}|^2 d\mu = \int_{\mathcal{A}_m^*} \widehat{A^*A} d\mu = \ell(A^*A) = (A^*Az, z)_H = \|Az\|_H^2.$$

Hence U_0 is an isometry from the dense subset $\mathcal{A}z$ of H into $L^2(\mathcal{A}_m^*)$. By uniform continuity, U_0 extends to an isometry U from H into $L^2(\mathcal{A}_m^*)$. As the continuous extension of the linear function U_0 , U is linear. The image of U contains $C(\mathcal{A}_m^*)$, which is dense in $L^2(\mathcal{A}_m^*, \mu)$, and the image is complete, being isometric with H . Therefore the image of U is closed. Consequently U carries H onto $L^2(\mathcal{A}_m^*, \mu)$ and is unitary.

We still have to check that $UAU^{-1} = \mathcal{M}(L^2(\mathcal{A}_m^*, \mu))$. If A and B are in \mathcal{A} , then

$$UAU^{-1}(\widehat{B}) = UA(Bz) = U(ABz) = \widehat{AB} = \widehat{A}\widehat{B} = M_{\widehat{A}}\widehat{B}.$$

Since UAU^{-1} and $M_{\widehat{A}}$ are bounded and since the \widehat{B} 's are dense in $L^2(\mathcal{A}_m^*, \mu)$, $UAU^{-1} = M_{\widehat{A}}$. Therefore $UAU^{-1} \subseteq \mathcal{M}(L^2(\mathcal{A}_m^*, \mu))$. Next let T be in $\mathcal{M}(L^2(\mathcal{A}_m^*, \mu))$. Then T commutes with every member of $\mathcal{M}(L^2(\mathcal{A}_m^*, \mu))$ and in particular with every UAU^{-1} . Thus $TUAU^{-1} = UAU^{-1}T$ for all A in \mathcal{A} , and $U^{-1}TUA = AU^{-1}TU$. Since A is arbitrary in \mathcal{A} , $U^{-1}TU$ is in \mathcal{A}' . But \mathcal{A} is assumed to be a maximal abelian self-adjoint subalgebra, and therefore $\mathcal{A}' = \mathcal{A}$. Consequently $U^{-1}TU$ is in \mathcal{A} . Say that $U^{-1}TU = A_0$. Then $T = UA_0U^{-1}$, and T is in UAU^{-1} . Therefore $UAU^{-1} = \mathcal{M}(L^2(\mathcal{A}_m^*, \mu))$. \square

The Spectral Theorem for a single bounded self-adjoint operator will be an immediate consequence of Theorem 4.53 and an application of Zorn's Lemma. But let us state the result (Theorem 4.54) so that it applies to a wider class of operators—and to a commuting family of such operators rather than just one.

The first step is to define the kinds of bounded linear operators of interest. Let H be a complex Hilbert space. A bounded linear operator $A : H \rightarrow H$ is said to be

- **normal** if $A^*A = AA^*$,
- **positive semidefinite** if it is self adjoint²² and $(Ax, x) \geq 0$ for all $x \in H$,
- **unitary** if A is onto H and has $\|Ax\| = \|x\|$ for all $x \in H$.

Self-adjoint operators, having $A^* = A$, are certainly normal. Every operator of the form A^*A for some bounded linear A is positive semidefinite. The definition of “unitary” merely specializes the definition before Theorem 4.53 to the case that $H_1 = H_2$. Unitary operators A in the present setting, according to Proposition 2.6, are characterized by the condition that A is invertible with $A^{-1} = A^*$, and unitary operators are therefore normal.

In the case of multiplication operators M_f by L^∞ functions on L^2 of a finite measure space, the adjoint of M_f is $M_{\bar{f}}$. Then every M_f is normal, M_f is self adjoint if and only if f is real-valued a.e., M_f is positive semidefinite if and only if f is ≥ 0 a.e., and M_f is unitary if and only if $|f| = 1$ a.e.

²²The condition “self adjoint” can be shown to be automatic in the presence of the inequality $(Ax, x) \geq 0$ for all x , but we shall not need to make use of this fact.

Theorem 4.54 (Spectral Theorem for bounded normal operators). Let $\{A_\alpha\}_{\alpha \in E}$ be a family of bounded normal operators on a complex separable Hilbert space H , and suppose that $A_\alpha A_\beta = A_\beta A_\alpha$ and $A_\alpha A_\beta^* = A_\beta^* A_\alpha$ for all α and β . Then there exist a finite measure space (S, μ) , a unitary operator $U : H \rightarrow L^2(S, \mu)$, and a set $\{f_\alpha\}_{\alpha \in E}$ of functions in $L^\infty(S, \mu)$ such that $U A_\alpha U^{-1} = M_{f_\alpha}$ for all α in E .

PROOF. Let \mathcal{A}_0 be the complex subalgebra of $\mathcal{B}(H, H)$ generated by I and all A_α and A_α^* for α in E . This algebra is commutative and is stable under $(\cdot)^*$. Let \mathcal{S} be the set of all commutative subalgebras of $\mathcal{B}(H, H)$ containing \mathcal{A}_0 and stable under $(\cdot)^*$, and partially order \mathcal{S} by inclusion upward. The union of the members of a chain in \mathcal{S} is an upper bound for the chain, and Zorn's Lemma therefore produces a maximal element \mathcal{A} in \mathcal{S} . Since \mathcal{A} is maximal, it is necessarily closed in the operator-norm topology. Then \mathcal{A} is a maximal abelian self-adjoint subalgebra of $\mathcal{B}(H, H)$, and Theorem 4.53 is applicable. The theorem yields a finite measure space (S, μ) and a unitary operator $U : H \rightarrow L^2(S, \mu)$ such that $U \mathcal{A} U^{-1} = \mathcal{M}(L^2(S, \mu))$. For each α in E , we then have $U A_\alpha U^{-1} = M_{f_\alpha}$ for some f_α in $L^\infty(S, \mu)$, as required. \square

In a corollary we shall characterize the spectra of operators that are self adjoint, or positive definite, or unitary. Implicitly in the statement and proof, we make use of Corollary 4.49 when referring to $\sigma(A)$: the set $\sigma(A)$ is independent of the Banach subalgebra of $\mathcal{B}(H, H)$ from which it is computed as long as that subalgebra contains I , A , and A^* . The corollary needs one further thing beyond Theorem 4.54, and we give that in the lemma below.

Lemma 4.55. Let (S, μ) be a finite measure space, and form the Hilbert space $L^2(S, \mu)$. For f in $L^\infty(S, \mu)$, let M_f be the operation of multiplication by f . Define the **essential image** of f to be

$$\{\lambda_0 \in \mathbb{C} \mid \mu(f^{-1}(\{\lambda \in \mathbb{C} \mid |\lambda - \lambda_0| < \epsilon\})) > 0 \text{ for every } \epsilon > 0\}.$$

Then

$$\sigma(M_f) = \text{essential image of } f.$$

PROOF. To prove \subseteq in the asserted equality, let λ_0 be outside the essential image, and choose $\epsilon > 0$ such that $f^{-1}(\{|\lambda - \lambda_0| < \epsilon\})$ has measure 0. Then $|f(x) - \lambda_0| \geq \epsilon$ a.e. Hence $1/(f - \lambda_0)$ is in L^∞ , and $M_{1/(f - \lambda_0)}$ exhibits $M_{f - \lambda_0}$ as invertible. Thus λ_0 is not in $\sigma(M_f)$.

For the inclusion \supseteq , suppose that $M_{f - \lambda_0}$ is invertible, with inverse T . For every g in L^∞ , we have $M_{f - \lambda_0} M_g = M_g M_{f - \lambda_0}$. Multiplying this equality by T twice, we obtain $M_g T = T M_g$. By Proposition 4.50, T is of the form $T = M_h$ for some h in L^∞ . Then we must have $(f - \lambda_0)h = 1$ a.e. Hence $|f(x) - \lambda_0| \geq \|h\|_\infty^{-1}$ a.e., and λ_0 is outside the essential image. This proves the lemma. \square

Corollary 4.56. Let H be a complex separable Hilbert space, let A be a normal operator in $\mathcal{B}(H, H)$, and let $\sigma(A)$ be the spectrum of A . Then

- (a) A is self adjoint if and only if $\sigma(A) \subseteq \mathbb{R}$,
- (b) A is positive semidefinite if and only if $\sigma(A) \subseteq [0, +\infty)$,
- (c) A is unitary if and only if $\sigma(A) \subseteq \{z \in \mathbb{C} \mid |z| = 1\}$.

PROOF. The corollary is immediate from Theorem 4.54 as long as the corollary is proved for any multiplication operator $A = M_f$ by an L^∞ function f on the Hilbert space $L^2(S, \mu)$. For this purpose we shall use Lemma 4.55.

In the case of (a), the operator M_f is self adjoint if and only if f is real-valued a.e. If f is real-valued, then the definition of essential image shows that λ_0 is not in the essential image if λ_0 is nonreal. Conversely if every nonreal λ_0 is outside the essential image, then to each such λ_0 we can associate a number $\epsilon_{\lambda_0} > 0$ for which $f^{-1}(\{\lambda \in \mathbb{C} \mid |\lambda - \lambda_0| < \epsilon_{\lambda_0}\})$ has μ measure 0. Countably many of the open sets $\{\lambda \in \mathbb{C} \mid |\lambda - \lambda_0| < \epsilon_{\lambda_0}\}$ cover the complement of \mathbb{R} in \mathbb{C} , and their inverse images under f have μ measure 0. Therefore the inverse image under f of the union has μ measure 0, and $\mu(f^{-1}(\mathbb{R}^c)) = 0$. That is, f is real-valued a.e. This proves (a), and the arguments for (b) and (c) are completely analogous. \square

The power of the Spectral Theorem comes through the functional calculus that it implies for working with operators. We shall prove the relevant theorem and then give five illustrations of how it is used.

Theorem 4.57 (functional calculus). Fix a bounded normal operator A on a complex separable Hilbert space H . Then there exists one and only one way to define a system of operators $\varphi(A)$ for every bounded Borel function φ on $\sigma(A)$ such that

- (a) $z(A) = A$ for the function $\varphi(z) = z$, and $1(A) = I$ for the constant function 1,
- (b) $\varphi \mapsto \varphi(A)$ is an algebra homomorphism into $\mathcal{B}(H, H)$,
- (c) $\varphi(A)^* = \overline{\varphi}(A)$,
- (d) $\lim_n \varphi_n(A)x = \varphi(A)x$ for all $x \in H$ whenever $\varphi_n \rightarrow \varphi$ pointwise with $\{\varphi_n\}$ uniformly bounded.

The operators $\varphi(A)$ have the additional properties that

- (e) $\varphi(A)$ is normal, and all the operators $\varphi(A)$ commute,
- (f) $\|\varphi(A)\| \leq \|\varphi\|_{\text{sup}}$,
- (g) $\lim_n \varphi_n(A) = \varphi(A)$ in the operator-norm topology whenever $\varphi_n \rightarrow \varphi$ uniformly,
- (h) $\sigma(\varphi(A)) \subseteq (\varphi(\sigma(A)))^{\text{cl}}$,
- (i) **(spectral mapping property)** $\sigma(\varphi(A)) = \varphi(\sigma(A))$ if φ is continuous.

PROOF OF EXISTENCE. Apply Theorem 4.54 to the singleton set $\{A\}$, obtaining a finite measure space (S, μ) , a unitary operator $U : H \rightarrow L^2(S, \mu)$, and an L^∞ function f_A on S such that $UAU^{-1} = M_{f_A}$. Examining the proofs of Theorems 4.53 and 4.54, we see that we can take S to be a certain compact Hausdorff space \mathcal{A}_m^* , μ to be a regular Borel measure on S , and the function f_A to be the Gelfand transform \widehat{A} , therefore continuous. In the construction of Theorem 4.53, the measure μ has the property that $\int_S |\widehat{B}|^2 d\mu = \|Bz\|_H^2$ for every B in \mathcal{A} , where z is a cyclic vector. Therefore $B \neq 0$ implies $\int_S |\widehat{B}|^2 d\mu > 0$. Since $|\widehat{B}|^2$ is the most general continuous function ≥ 0 on S , μ assigns positive measure to every nonempty open set.

For any bounded Borel function φ on $\sigma(A)$, the function $\varphi \circ f_A$ is a well-defined function on S since Proposition 4.43a shows that the image of $\widehat{A} = f_A$ is $\sigma(A)$. The function $\varphi \circ f_A$ is a bounded Borel function since φ^{-1} of an open set in \mathbb{C} is a Borel set of \mathbb{C} and since f_A^{-1} of a Borel set of \mathbb{C} is a Borel set of S . Thus it makes sense to define

$$\varphi(A) = U^{-1}M_{\varphi \circ f_A}U.$$

Then we see that properties (a) through (i) are satisfied for any given normal A on H if they are valid in the special case of any M_f on $L^2(S, \mu)$ with f continuous, S compact Hausdorff, μ a regular Borel measure assigning positive measure to every nonempty open set, and $\varphi(M_f)$ defined for arbitrary bounded Borel functions φ on the image of f by

$$\varphi(M_f) = M_{\varphi \circ f}.$$

Properties (a) through (c) for multiplication operators are immediate, (d) follows by dominated convergence, (e) and (f) are immediate, and (g) follows directly from (f). We are left with properties (h) and (i).

Lemma 4.55 identifies the spectrum of a multiplication operator by an L^∞ function with the essential image of the function. Using this identification, we see that (h) and (i) follow in our special case if it is proved for f continuous that

$$\begin{aligned} \text{essential image of } \varphi \circ f &\subseteq (\varphi(\text{essential image of } f))^{\text{cl}}, \quad \varphi \text{ bounded Borel, } (*) \\ \text{essential image of } \varphi \circ f &= \varphi(\text{essential image of } f), \quad \varphi \text{ continuous. } (**) \end{aligned}$$

Let us see that these follow if we prove that

$$\begin{aligned} \text{essential image of } \psi &\subseteq (\text{image } \psi)^{\text{cl}} \quad \text{for } \psi : S \rightarrow \mathbb{C} \text{ bounded Borel, } (\dagger) \\ \text{essential image of } \psi &= \text{image } \psi \quad \text{for } \psi : S \rightarrow \mathbb{C} \text{ continuous. } (\dagger\dagger) \end{aligned}$$

In fact, if (\dagger) and $(\dagger\dagger)$ hold, then for $(*)$ we have

$$\begin{aligned} \text{essential image}(\varphi \circ f) &\subseteq (\text{image}(\varphi \circ f))^{\text{cl}} && \text{by } (\dagger) \text{ for } \varphi \circ f \\ &= (\varphi(\text{image } f))^{\text{cl}} \\ &= (\varphi(\text{essential image } f))^{\text{cl}} && \text{by } (\dagger\dagger) \text{ for } f. \end{aligned}$$

For $(**)$ we have

$$\begin{aligned} \text{essential image}(\varphi \circ f) &= \text{image}(\varphi \circ f) && \text{by } (\dagger\dagger) \text{ for } \varphi \circ f \\ &= \varphi(\text{image } f) \\ &= \varphi(\text{essential image } f) && \text{by } (\dagger\dagger) \text{ for } f. \end{aligned}$$

Thus it is enough to prove (\dagger) and $(\dagger\dagger)$. For (\dagger) let λ_0 be in the essential image of ψ . Then for each $n \geq 1$, $\mu(\psi^{-1}\{\lambda \mid |\lambda - \lambda_0| < \frac{1}{n}\}) > 0$, and hence $\psi^{-1}\{\lambda \mid |\lambda - \lambda_0| < \frac{1}{n}\} \neq \emptyset$. Thus there exists $\lambda = \lambda_n$ with λ_n in the image of ψ such that $|\lambda - \lambda_0| < \frac{1}{n}$, and λ_0 is exhibited as a member of $(\text{image } \psi)^{\text{cl}}$.

For $(\dagger\dagger)$ we first show that the image of ψ lies in the essential image of ψ if ψ is continuous. Thus let λ_0 be in the image of ψ . Then $\psi^{-1}\{\lambda \mid |\lambda - \lambda_0| < \epsilon\}$ is nonempty, and it is open since ψ is continuous. Since nonempty open sets of S have positive μ measure, we conclude that λ_0 is in the essential image of ψ . Then

$$\begin{aligned} \text{image } \psi &\subseteq \text{essential image } \psi && \text{by what we have just proved} \\ &\subseteq (\text{image } \psi)^{\text{cl}} && \text{by } (\dagger) \\ &= \text{image } \psi && \text{since } S \text{ is compact and } \psi \text{ is continuous,} \end{aligned}$$

and $(\dagger\dagger)$ follows. This completes the proof of existence and the list of properties in Theorem 4.57. \square

PROOF OF UNIQUENESS. Properties (a) through (c) determine $\varphi(A)$ whenever φ is a polynomial function of z and \bar{z} . By the Stone–Weierstrass Theorem any continuous φ on a compact set such as $\sigma(A)$ is the uniform limit of such polynomials, and hence (d) implies that $\varphi(A)$ is determined whenever φ is continuous.

The indicator function of a compact subset of \mathbb{C} is the decreasing pointwise limit of a sequence of continuous functions of compact support, and hence (d) implies that $\varphi(A)$ is determined whenever φ is the indicator function of a compact set. Applying (b) twice, we see that $\varphi(A)$ is determined whenever φ is the indicator function of any finite disjoint union of differences of compact sets. Such sets form²³ the smallest algebra of sets containing the compact subsets of

²³By Lemma 11.2 of *Basic*.

$\sigma(A)$. Another application of (d), together with the Monotone Class Lemma,²⁴ shows that $\varphi(A)$ is determined whenever φ is the indicator function of any Borel subset of $\sigma(A)$. Any bounded Borel function on $\sigma(A)$ is the uniform limit of finite linear combinations of indicator functions of Borel sets, and hence one more application of (b) and (d) shows that $\varphi(A)$ is determined whenever φ is a bounded Borel function on $\sigma(A)$. \square

Corollary 4.58. If H is a complex separable Hilbert space, then every positive semidefinite operator in $\mathcal{B}(H, H)$ has a unique positive semidefinite square root.

REMARKS. This is an important application of the Spectral Theorem and the functional calculus. It is already important when applied to operators of the form A^*A with A in $\mathcal{B}(H, H)$. For example the corollary allows us in the definition of trace-class operator before Proposition 2.8 to drop the assumption that the operator is compact; it is enough to assume that it is bounded.

PROOF. If A is positive semidefinite, then $\sigma(A) \subseteq [0, \infty)$ by Corollary 4.56b. The usual square root function $\sqrt{\cdot}$ on $[0, \infty)$ is bounded on $\sigma(A)$, and we can form \sqrt{A} by Theorem 4.57. Then (a) and (b) in Theorem 4.57 imply that $(\sqrt{A})^2 = A$, and (i) implies that \sqrt{A} is positive semidefinite. This proves existence.

For uniqueness let B be positive semidefinite with $B^2 = A$. Because of the uniqueness assertion in Theorem 4.57, we have at our disposal the maximal abelian self-adjoint subalgebra of $\mathcal{B}(H, H)$ that is recalled from Theorem 4.53 and used to define operators $\varphi(A)$ in the proof of Theorem 4.57. Let \mathcal{A}_0 be the smallest C^* algebra in $\mathcal{B}(H, H)$ containing I , A , and B , and extend \mathcal{A}_0 to a maximal abelian self-adjoint subalgebra \mathcal{A} of $\mathcal{B}(H, H)$. We use this \mathcal{A} to define \sqrt{A} . On the compact Hausdorff space, $\widehat{\sqrt{A}}$ and \widehat{B} are both nonnegative square roots of \widehat{A} and must be equal. Since the Gelfand transform for \mathcal{A} is one-one, $B = \sqrt{A}$. \square

Corollary 4.59. Let H be a complex separable Hilbert space, and let A and B be bounded normal operators on H such that A commutes with B and B^* . Then each $\varphi(A)$, for φ a bounded Borel function on $\sigma(A)$, commutes with B and B^* .

PROOF. As in the proof of the previous corollary, we have at our disposal the maximal abelian self-adjoint subalgebra \mathcal{A} of $\mathcal{B}(H, H)$ that is used to define operators $\varphi(A)$. We choose one containing I , A , and B . Then $\varphi(A)$ is in \mathcal{A} and hence commutes with B and B^* . \square

Corollary 4.60. Let A be a bounded normal operator on a complex separable Hilbert space, let $\varphi_2 : \sigma(A) \rightarrow \mathbb{C}$ be a continuous function,

²⁴Lemma 5.43 of *Basic*.

and let $\varphi_1 : \varphi_2(\sigma(A)) \rightarrow \mathbb{C}$ be a bounded Borel function. Then $\varphi_1(\varphi_2(A)) = (\varphi_1 \circ \varphi_2)(A)$.

REMARK. If $\varphi_2(z) = \bar{z}$, this corollary recovers property (c) in Theorem 4.57.

PROOF. The uniqueness in Theorem 4.57 shows that the operators $\varphi(\varphi_2(A))$ form the unique system defined for bounded Borel functions $\varphi : \sigma(\varphi_2(A)) \rightarrow \mathbb{C}$ such that $z(\varphi_2(A)) = \varphi_2(A)$, $1(\varphi_2(A)) = 1$, $\varphi \mapsto \varphi(\varphi_2(A))$ is an algebra homomorphism, $\varphi(\varphi_2(A))^* = \overline{\varphi}(\varphi_2(A))$, and $\lim \varphi_n(\varphi_2(A))x = \varphi(\varphi_2(A))x$ for all x whenever $\varphi_n \rightarrow \varphi$ pointwise and boundedly on $\sigma(\varphi_2(A))$.

We now consider the system formed from $\psi(A)$, specialize to functions $\psi = \varphi \circ \varphi_2$, and make use of the properties of $\psi(A)$ as stated in the existence half of the theorem. Theorem 4.57i shows that $\sigma(\varphi_2(A)) = \varphi_2(\sigma(A))$. We have $(z \circ \varphi_2)(A) = \varphi_2(A)$ trivially and $(1 \circ \varphi_2)(A) = 1(A) = 1$ by (a) for the system $\psi(A)$. The map $\varphi \mapsto (\varphi \circ \varphi_2)(A)$ is an algebra homomorphism as a special case of (b) for $\psi(A)$. The formula $(\varphi \circ \varphi_2)(A)^* = \overline{\varphi \circ \varphi_2}(A) = (\overline{\varphi} \circ \varphi_2)(A)$ is a special case of (c) for $\psi(A)$. And the formula $\lim(\varphi_n \circ \varphi_2)(A)x = (\varphi \circ \varphi_2)(A)x$ is a special case of (d) for $\psi(A)$. Therefore the system $(\varphi \circ \varphi_2)(A)$ has the properties that uniquely determine the system $\varphi(\varphi_2(A))$, and we must have $\varphi(\varphi_2(A)) = (\varphi \circ \varphi_2)(A)$ for every bounded Borel function φ on $\sigma(\varphi_2(A))$. \square

Corollary 4.61. If A is a bounded normal operator on a complex separable Hilbert space, then there exists a sequence $\{S_n\}$ of bounded linear operators of the form $S_n = \sum_{i=1}^{N_n} c_{i,n} E_{i,n}$ converging to A in the operator-norm topology and having the property that each $E_{i,n}$ is an orthogonal projection of the form $\varphi(A)$.

PROOF. Choose a sequence of simple Borel functions s_n on $\sigma(A)$ converging uniformly to the function z , and let $S_n = s_n(A)$. Then apply Theorem 4.57. \square

Corollary 4.62. If A is a bounded normal operator on a complex separable Hilbert space H of dimension > 1 , then there exists a nontrivial orthogonal projection that commutes with every bounded normal operator that commutes with A and A^* . Hence there is a nonzero proper closed vector subspace K of H such that $B(K) \subseteq K$ for every bounded normal operator B commuting with A and A^* .

PROOF. This is a special case of Corollary 4.61. \square

This completes our list of illustrations of the functional calculus associated with the Spectral Theorem. We now prove a result mentioned near the end of Section 10, showing how the spectrum of an operator relates to spaces of maximal ideals.

Proposition 4.63. Let A be a bounded normal operator on a complex separable Hilbert space H , and let \mathcal{A} be the smallest C^* algebra of $\mathcal{B}(H, H)$ containing I , A , and A^* . Then the maximal ideal space \mathcal{A}_m^* is canonically homeomorphic to the spectrum $\sigma(A)$.

PROOF. Let $B \mapsto \widehat{B}$ be the Gelfand transform for \mathcal{A} , carrying \mathcal{A} to $C(\mathcal{A}_m^*)$. Proposition 4.43a shows that the image of \widehat{A} in \mathbb{C} is $\sigma(A)$, and Corollary 4.49 shows that this version of $\sigma(A)$ is the same as the one obtained from $\mathcal{B}(H, H)$. Therefore we obtain a map $C(\sigma(A)) \rightarrow C(\mathcal{A}_m^*)$ by the definition $f \mapsto f \circ \widehat{A}$. This map is an algebra homomorphism respecting conjugation, and it satisfies $\|f\|_{\text{sup}} = \|f \circ \widehat{A}\|_{\text{sup}}$ since the function \widehat{A} is onto $\sigma(A)$. This equality of norms implies that the map $f \mapsto f \circ \widehat{A}$ is one-one.

To see that $f \mapsto f \circ \widehat{A}$ is onto $C(\mathcal{A}_m^*)$, we observe that the operators $p(A, A^*)$, for p a polynomial in z and \bar{z} , are dense in \mathcal{A} since I , A , and A^* generate \mathcal{A} . Using that $(\widehat{\cdot})$ is a norm-preserving isomorphism of \mathcal{A} onto $C(\mathcal{A}_m^*)$, we see that the members $p(\widehat{A}, \widehat{A}^*)$ of $C(\mathcal{A}_m^*)$ are dense in $C(\mathcal{A}_m^*)$. Since $C(\sigma(A))$ is complete and $f \mapsto f \circ \widehat{A}$ is norm preserving, the image is closed. Therefore $f \mapsto f \circ \widehat{A}$ carries $C(\sigma(A))$ onto $C(\mathcal{A}_m^*)$.

Hence we have a canonical isomorphism of commutative C^* algebras $C(\sigma(A))$ and $C(\mathcal{A}_m^*)$. The maximal ideal spaces must be canonically homeomorphic. The maximal ideal space of $C(\sigma(A))$ contains $\sigma(A)$ because of the point evaluations but can be no larger than $\sigma(A)$ since the Stone Representation Theorem (Theorem 4.15) shows that the necessarily closed image of $\sigma(A)$ is dense in $(C(\sigma(A)))_m^*$. \square

FURTHER REMARKS. A version of the Spectral Theorem is valid also for *unbounded* self-adjoint operators on a complex separable Hilbert space. Such operators are of importance since they enable one to use functional analysis directly with linear differential operators, which may be expected to be unbounded. The operator L in the Sturm–Liouville theory of Chapter I is an example of the kind of operator that one wants to handle directly. The subject has to address a large number of technical details, particularly concerning domains of operators, and the definitions have to be made just right. The prototype of an unbounded self-adjoint operator is the multiplication operator M_f on our usual $L^2(S, \mu)$ corresponding to an unbounded real-valued function f that is finite almost everywhere; the domain of M_f is the dense vector subspace of members of L^2 whose product with f is in L^2 . Just as in this example, the domain of an unbounded self-adjoint operator is forced by the definitions to be a dense but proper vector subspace of the whole Hilbert space. Once one is finally able to state the Spectral Theorem for unbounded self-adjoint operators precisely, the result is proved by reducing it to Theorem 4.54. Specifically if T is an unbounded self-adjoint operator on H , then one shows that $(T + i)^{-1}$ is a globally defined bounded normal operator.

Application of Theorem 4.54 to $(T + i)^{-1}$ yields an L^∞ function g such that the unitary operator $U : H \rightarrow L^2(S, \mu)$ carries $(T + i)^{-1}$ to g . One wants T to be carried to f , and hence the definition should force $1/(f + i) = g$. In other words, f is defined by the equation $f = 1/g - i$. One checks that the unitary operator U from H to L^2 indeed carries T to M_f . For a discussion of the use of the Spectral Theorem in connection with partial differential equations, the reader can look at Parts 2 and 3 of Dunford–Schwartz's *Linear Operators*.

BIBLIOGRAPHICAL REMARKS. The exposition in Section 3–6 and Section 8–9 is based on that in Part 1 of Dunford–Schwartz's *Linear Operators*. The exposition in Section 7 is based on that in Treves's *Topological Vector Spaces, Distributions and Kernels*.

12. Problems

1. Let X be a Banach space, and let Y be a closed vector subspace. Take as known (from Problem 4 in Chapter XII of *Basic*) that X/Y becomes a normed linear space under the definition $\|x + Y\| = \inf_{y \in Y} \|x + y\|$ and that the resulting norm is complete. Prove that the topology on X/Y obtained this way coincides with the quotient topology on X/Y as the quotient of a topological vector space by a closed vector subspace.
2. Let $T : X \rightarrow Y$ be a linear function between Banach spaces such that $T(X)$ is finite-dimensional and $\ker(T)$ is closed. Prove that T is continuous.
3. Using the result of Problem 1, derive the Interior Mapping Theorem for Banach spaces from the special case in which the mapping is one-one.
4. If X is a finite-dimensional normed linear space, why must the norm topology coincide with the weak topology?
5. Let H be a separable infinite-dimensional Hilbert space. Give an example of a sequence $\{x_n\}$ in H with $\|x_n\| = 1$ for all n and with $\{x_n\}$ tending to 0 weakly.
6. In a σ -finite measure space (S, μ) , suppose that the sequence $\{f_n\}$ tends weakly to f in $L^2(S, \mu)$ and that $\lim_n \|f_n\|_2 = \|f\|_2$. Prove that $\{f_n\}$ tends to f in the norm topology of $L^2(S, \mu)$.
7. Let X be a normed linear space, let $\{x_n\}$ be a sequence in X with $\{\|x_n\|\}$ bounded, and let x_0 be in X . Prove that if $\lim_n x^*(x_n) = x^*(x_0)$ for all x^* in a dense subset of X^* , then $\{x_n\}$ tends to x_0 weakly.
8. Fix p with $0 < p < 1$. It was shown in Section 1 that the set of Borel functions f on $[0, 1]$ with $\int_{[0,1]} |f|^p dx < \infty$, with two functions identified when they are equal almost everywhere, forms a topological vector space $L^p([0, 1])$ under the metric $d(f, g) = \int_{[0,1]} |f - g| dx$. Put $D(f) = \int_{[0,1]} |f|^p dx$.

- (a) Show for each positive integer n that any function f with $D(f) = 1$ can be written as $f = \frac{1}{n}(f_1 + \cdots + f_n)$ with $D(f_j) = n^{-(1-p)}$.
- (b) Deduce from (a) that if f has $D(f) = 1$, then an arbitrarily large multiple of f can be written as a convex combination of functions f_j with $D(f_j) \leq 1$.
- (c) Deduce from (b) for each $\varepsilon > 0$ that the smallest convex set containing all f 's with $D(f) \leq \varepsilon$ is all of $L^p([0, 1])$.
- (d) Why must $L^p([0, 1])$ fail to be locally convex?
- (e) Prove that $L^p([0, 1])$ has no nonzero continuous linear functionals.
9. Let U be a nonempty open set in \mathbb{R}^N , and let $\{K_p\}_{p \geq 0}$ be an exhausting sequence of compact subsets of U with $K_0 = \emptyset$. Let M be the set of all monotone increasing sequences of integers $m_p \geq 0$ tending to infinity, and let E be the set of all monotone decreasing sequences of real numbers $\varepsilon_p > 0$ tending to 0. For each pair $(m, \varepsilon) = (\{m_p\}, \{\varepsilon_p\})$ with $m \in M$ and $\varepsilon \in E$, define a seminorm $\|\cdot\|_{m, \varepsilon}$ on $C_{\text{com}}^\infty(U)$ by

$$\|\varphi\|_{m, \varepsilon} = \sup_{p \geq 0} \varepsilon_p^{-1} \left(\sup_{x \notin K_p} \sup_{|\alpha| \leq m_p} |(D^\alpha \varphi)(x)| \right).$$

Denote the inductive limit topology on $C_{\text{com}}^\infty(U)$ by \mathcal{T} and the topology defined with the above uncountable family of seminorms by \mathcal{T}' .

- (a) Verify for φ in $C^\infty(U)$ that $\|\varphi\|_{m, \varepsilon} < \infty$ for all pairs (m, ε) if and only if φ is in $C_{\text{com}}^\infty(U)$.
- (b) Prove that the identity mapping $(C_{\text{com}}^\infty(U), \mathcal{T}) \rightarrow (C_{\text{com}}^\infty(U), \mathcal{T}')$ is continuous.
- (c) For $p \geq 0$, fix $\psi_p \geq 0$ in $C_{\text{com}}^\infty(U)$ with $\sum_p \psi_p = 1$, $\psi_0 \neq 0$ on K_2 , and

$$\psi_p(x) \begin{cases} \neq 0 \text{ for } x \text{ in } K_{p+2} - K_{p+1}^0, \\ = 0 \text{ for } x \text{ in } (K_{p+3}^0)^c \text{ and for } x \text{ in } K_p. \end{cases}$$

A basic open neighborhood N of 0 in $(C_{\text{com}}^\infty(U), \mathcal{T})$ is a convex circled set with 0 as an internal point satisfying conditions of the following form: for each $p \geq 0$, there exist an integer n_p and a real $\delta_p > 0$ such that a member φ of $C_{K_{p+3}}^\infty$ is in $N \cap C_{K_{p+3}}^\infty$ if and only if $\sup_{x \in K_{p+3}} \sup_{|\alpha| \leq n_p} |D^\alpha \varphi(x)| < \delta_p$. Prove that there exists a pair (m, ε) such that $\|\varphi\|_{m, \varepsilon} < 1$ implies that $2^{p+1} \psi_p \varphi$ is in $N \cap C_{K_{p+3}}^\infty$ for all $p \geq 0$.

- (d) With notation as in (c), show that the function $\varphi = \sum_{p \geq 0} 2^{-(p+1)} (2^{p+1} \psi_p \varphi)$ is in N whenever $\|\varphi\|_{m, \varepsilon} < 1$. Conclude that the identity mapping from $(C_{\text{com}}^\infty(U), \mathcal{T}')$ to $(C_{\text{com}}^\infty(U), \mathcal{T})$ is continuous and that \mathcal{T} and \mathcal{T}' are therefore the same.
- (e) Exhibit a sequence of closed nowhere dense subsets of $C_{\text{com}}^\infty(U)$ with union $C_{\text{com}}^\infty(U)$, thereby showing that the hypotheses of the Baire Category Theorem must not be satisfied in $C_{\text{com}}^\infty(U)$.

10. Prove or disprove: If H is an infinite-dimensional separable Hilbert space, then $\mathcal{B}(H, H)$ is separable in the operator-norm topology.
11. Let S be a compact Hausdorff space, let μ be a regular Borel measure on S , and regard $\mathcal{A} = \{\text{multiplications by } C(S)\}$ as a subalgebra of $\mathcal{M}(L^2(S, \mu))$. Prove that the commuting algebra \mathcal{A}' of \mathcal{A} within $\mathcal{B}(L^2(S, \mu), L^2(S, \mu))$ is $\mathcal{M}(L^2(S, \mu))$.
12. Prove that if A is a bounded normal operator on a separable complex Hilbert space H , then $\|A\| = \sup_{\|x\| \leq 1} |(Ax, x)_H|$.
13. Let H be a separable complex Hilbert space, let \mathcal{A} be a commutative C^* subalgebra of $\mathcal{B}(H, H)$ with identity, and suppose that \mathcal{A} has a cyclic vector. Prove that there exist a regular Borel measure μ on \mathcal{A}_m^* and a unitary operator $U : H \rightarrow L^2(\mathcal{A}_m^*, \mu)$ such that

$$UAU^{-1} = \{\text{multiplications by } C(\mathcal{A}_m^*)\} \subseteq \mathcal{M}(L^2(\mathcal{A}_m^*, \mu)).$$

14. Let A be a bounded normal operator on a separable complex Hilbert space H , and let \mathcal{A} be the smallest C^* subalgebra of $\mathcal{B}(H, H)$ containing I , A , and A^* . Suppose that \mathcal{A} has a cyclic vector. Prove that there exists a Borel measure on the spectrum $\sigma(A)$ and a unitary mapping $U : H \rightarrow L^2(\sigma(A), \mu)$ such that

$$UAU^{-1} = \{\text{multiplications by } C(\sigma(A))\} \subseteq \mathcal{M}(L^2(\sigma(A), \mu))$$

and such that UAU^{-1} is the multiplication operator M_z .

15. Form the multiplication operator M_x on $L^2([0, 1])$, and let \mathcal{A} be the smallest C^* subalgebra of $\mathcal{B}(L^2([0, 1]), L^2([0, 1]))$ containing I and M_x .
- Prove that the function 1 is a cyclic vector for \mathcal{A} .
 - Identify the spectrum $\sigma(M_x)$.
 - Prove in the context of the functional calculus of the Spectral Theorem that the operator $\varphi(M_x)$ is M_φ for every bounded Borel function φ on the spectrum $\sigma(M_x)$.
16. Let A and B be bounded normal operators on a separable complex Hilbert space H such that A commutes with B and B^* . Let \mathcal{A} be the smallest C^* subalgebra of $\mathcal{B}(H, H)$ containing I , A , A^* , B , and B^* .
- Prove that \mathcal{A}_m^* is canonically homeomorphic to the subset $\sigma(A, B)$ of $\sigma(A) \times \sigma(B) \subseteq \mathbb{C}^2$ given by $\sigma(A, B) = \{(\widehat{A}(\ell), \widehat{B}(\ell))\}_{\ell \in \mathcal{A}_m^*}$.
 - Prove under the identification of (a) that \widehat{A} is identified with the function z_1 and \widehat{B} is identified with z_2 .

Problems 17–20 concern the set of extreme points in particular closed subsets of locally convex topological vector spaces.

17. Let S be a compact Hausdorff space, and let K be the set of all regular Borel measures on S with $\mu(S) \leq 1$. Give K the weak-star topology relative to $C(S)$. Prove that the extreme points of K are 0 and the point masses of total measure 1.
18. In $L^1([0, 1])$, suppose that f has norm 1 and that E is a Borel subset such that $\int_E |f| dx > 0$ and $\int_{E^c} |f| dx > 0$. Let f_1 be f on E and be 0 on E^c , and let f_2 be f on E^c and be 0 on E .
- Prove that f is a nontrivial convex combination of $\|f_1\|_1^{-1} f_1$ and $\|f_2\|_1^{-1} f_2$.
 - Conclude that the closed unit ball of $L^1([0, 1])$ has no extreme points.
19. Let S be a compact Hausdorff space, and let K_1 be the set of all regular Borel measures on S with $\mu(S) = 1$. Give K_1 the weak-star topology relative to $C(S)$. Let F be a homeomorphism of S . Within K_1 , let K be the subset of members μ of K_1 that are F invariant in the sense that $\mu(E) = \mu(F^{-1}(E))$ for all Borel sets E .
- Prove that K is a compact convex subset of $M(S)$ in the weak-star topology relative to $C(S)$.
 - A member μ of K is said to be **ergodic** if every Borel set E such that $F(E) = E$ has the property that $\mu(E) = 0$ or $\mu(E) = 1$. Prove that every extreme point of K is ergodic.
 - Is every ergodic measure in K necessarily an extreme point?
20. Regard the set \mathbb{Z} of integers as a measure space with the counting measure imposed. As in Section 8, a complex-valued function $f(n)$ on \mathbb{Z} is said to be **positive definite** if $\sum_{j,k} c(j) f(j-k) \overline{c(k)} \geq 0$ for all complex-valued functions $c(n)$ on the integers with finite support.
- Prove that every positive definite function f has $f(0) \geq 0$, $f(-n) = \overline{f(n)}$, and $|f(n)| \leq f(0)$.
 - Prove that a bounded sequence in $L^\infty(\mathbb{Z})$ converges weak-star relative to $L^1(\mathbb{Z})$ if and only if it converges pointwise.
 - In view of (a), the set K of positive definite functions f with $f(1) = 1$ is a subset of the closed unit ball of $L^\infty(\mathbb{Z})$. Prove that the set K is convex and is compact in the weak-star topology relative to $L^1(\mathbb{Z})$.
 - Prove that every function $f_\theta(n) = e^{in\theta}$ with θ real is an extreme point of K .
 - Take for granted the fact that every positive definite function on \mathbb{Z} is the sequence of Fourier coefficients of some Borel measure on the circle. (The corresponding fact for positive definite functions on \mathbb{R}^N is proved in Problems 8–12 of Chapter VIII of *Basic*.) Prove that the set K has no other extreme points besides the ones in (d).

Problems 21–25 elaborate on the Stone Representation Theorem, Theorem 4.15. The first of the problems gives a direct proof, without using the Gelfand–Mazur Theorem, that every multiplicative linear functional is continuous in the context of Theorem 4.15.

21. Let S be a nonempty set, and let \mathcal{A} be a uniformly closed subalgebra of $B(S)$ containing the constants and stable under complex conjugation. Let C be a complex number with $|C| > 1$, let f be a member of \mathcal{A} with $\|f\|_{\text{sup}} \leq 1$, and let ℓ be a multiplicative linear functional on \mathcal{A} .
- Show that $\sum_{n=0}^{\infty} (f/C)^n$ converges and that its sum x provides an inverse to $1 - (f/C)$ under multiplication.
 - By applying ℓ to the identity $(1 - (f/C))x = 1$, prove that $\ell(f) = C$ is impossible.
 - Conclude from (b) that $\|\ell\| \leq 1$, hence that ℓ is automatically bounded.
22. Let S be a compact Hausdorff space, and let ℓ be a multiplicative linear functional on $C(S)$ such that $\ell(\bar{f}) = \overline{\ell(f)}$ for all f in $C(S)$. Prove that ℓ is the evaluation e_s at some point s of S .
23. Let S and T be two compact Hausdorff spaces, and let $U : C(S) \rightarrow C(T)$ be an algebra homomorphism that carries 1 to 1 and respects complex conjugation.
- Prove that there exists a unique continuous map $u : T \rightarrow S$ such that $(Uf)(t) = f(u(t))$ for every $t \in T$ and $f \in C(S)$.
 - Prove that if U is one-one, then u is onto.
 - Prove that if U is an isomorphism, then u is a homeomorphism.
24. Let X be a compact Hausdorff space, and let \mathcal{A} and \mathcal{B} be uniformly closed subalgebras of $B(X)$ containing the constants and stable under complex conjugation. Suppose that $\mathcal{A} \subseteq \mathcal{B}$. Suppose that S, p, U and T, q, V are data such that S and T are compact Hausdorff spaces, $p : X \rightarrow S$ and $q : X \rightarrow T$ are functions with dense image, and $U : \mathcal{A} \rightarrow C(S)$ and $V : \mathcal{B} \rightarrow C(T)$ are algebra isomorphisms carrying 1 to 1 and respecting complex conjugations such that for every $x \in X$, $(Uf)(p(x)) = f(x)$ for all $f \in \mathcal{A}$ and $(Vg)(q(x)) = g(x)$ for all $g \in \mathcal{B}$. Prove that there exists a unique continuous map $\Phi : T \rightarrow S$ such that $p = \Phi \circ q$. Prove also that this map satisfies $(Uf)(\Phi(t)) = (Vf)(t)$ for all f in \mathcal{A} .
25. Formulate and prove a uniqueness statement to complement the existence statement in Theorem 4.15.

Problems 26–30 concern inductive limits. As mentioned in a footnote in the text, “direct limit” is a construction in category theory that is useful within several different settings. These problems concern the setting of topological spaces and continuous maps between them. For this setting a direct limit is something attached to a **directed system** of topological spaces and continuous maps. For the latter let (I, \leq) be a directed set, and suppose that W_i is a topological space for each i in I . Suppose that a one-one continuous map $\psi_{ji} : W_i \rightarrow W_j$ is defined whenever $i \leq j$, and suppose that these maps satisfy $\psi_{ii} = 1$ and $\psi_{ki} = \psi_{kj} \circ \psi_{ji}$ whenever $i \leq j \leq k$. A **direct limit** of this directed system consists of a topological space W and continuous maps $q_i : W_i \rightarrow W$ for each i in I satisfying the following universal mapping property: whenever continuous maps $\varphi_i : W_i \rightarrow Z$ are given for each i such that $\varphi_j \circ \psi_{ji} = \varphi_i$

for $i \leq j$, then there exists a unique continuous map $\Phi : W \rightarrow Z$ such that $\varphi_i = \Phi \circ q_i$ for all i .

26. Suppose that a directed system of topological spaces and continuous maps is given with notation as above. Let $\coprod_i W_i$ denote the disjoint union of the spaces W_i , topologized so that each W_i appears as an open subset of the disjoint union. Define an equivalence relation \sim on $\coprod_i W_i$ as follows: if x_i is in W_i and x_j is in W_j , then $x_i \sim x_j$ means that there is some k with $i \leq k$ and $j \leq k$ such that $\psi_{ki}(x_i) = \psi_{kj}(x_j)$.
- (a) Prove that \sim is an equivalence relation.
- (b) Prove that elements x_i in W_i and x_j in W_j have $x_i \sim x_j$ if and only if every l with $i \leq l$ and $j \leq l$ has $\psi_{li}(x_i) = \psi_{lj}(x_j)$.
27. Define W to be the quotient $\coprod_i W_i / \sim$, and give W the quotient topology. Let $q : \coprod_i W_i \rightarrow W$ be the quotient map. Prove that W and the system of maps $q|_{W_i}$ form a direct limit of the given directed system.
28. Prove that if $(V, \{p_i\})$ and $(W, \{q_i\})$ are two direct limits of the given system, then there exists a unique homeomorphism $F : V \rightarrow W$ such that $q_i = F \circ p_i$ for all i in I .
29. Suppose that each map $\psi_i : W_i \rightarrow W_j$ is a homeomorphism onto an open subset.
- (a) Prove that the quotient map $q : \coprod_i W_i \rightarrow W$ carries open sets to open sets.
- (b) Prove that the direct limit W is Hausdorff if each given W_i is Hausdorff.
- (c) Prove that the direct limit W is locally compact Hausdorff if each W_i is locally compact Hausdorff.
- (d) Give an example in which each W_i is compact Hausdorff but the direct limit W is not compact.
30. Let I be a nonempty index set, and let S_0 be a finite subset. Suppose that a locally compact Hausdorff space X_i is given for each $i \in I$ and that a compact open subset K_i is specified for each $i \notin S_0$. For each finite subset S of I containing S_0 , define

$$X(S) = \left(\prod_{i \in S} X_i \right) \times \left(\prod_{i \notin S} K_i \right),$$

giving it the product topology. If S_1 and S_2 are two finite subsets of I containing S_0 such that $S_1 \subseteq S_2$, then the inclusion $\psi_{S_2, S_1} : X(S_1) \rightarrow X(S_2)$ is a homeomorphism onto an open set, and these homeomorphisms are compatible under composition. The resulting direct limit X is called the **restricted direct product** of the X_i 's with respect to the K_i 's. Prove that X is locally compact Hausdorff and that elements of X may be regarded as tuples (x_i) for which x_i is in X_i for all i while x_i is in K_i for all but finitely many i .

CHAPTER V

Distributions

Abstract. This chapter makes a detailed study of distributions, which are continuous linear functionals on vector spaces of smooth scalar-valued functions. The three spaces of smooth functions that are studied are the space $C_{\text{com}}^{\infty}(U)$ of smooth functions with compact support in an open set U , the space $C^{\infty}(U)$ of all smooth functions on U , and the space of Schwartz functions $S(\mathbb{R}^N)$ on \mathbb{R}^N . The corresponding spaces of continuous linear functionals are denoted by $\mathcal{D}'(U)$, $\mathcal{E}'(U)$, and $\mathcal{S}'(\mathbb{R}^N)$.

Section 1 examines the inclusions among the spaces of smooth functions and obtains the conclusion that the corresponding restriction mappings on distributions are one-one. It extends from $\mathcal{E}'(U)$ to $\mathcal{D}'(U)$ the definition given earlier for support, it shows that the only distributions of compact support in U are the ones that act continuously on $C^{\infty}(U)$, it gives a formula for these in terms of derivatives and compactly supported complex Borel measures, and it concludes with a discussion of operations on smooth functions.

Sections 2–3 introduce operations on distributions and study properties of these operations. Section 2 briefly discusses distributions given by functions, and it goes on to work with multiplications by smooth functions, iterated partial derivatives, linear partial differential operators with smooth coefficients, and the operation $(\cdot)^{\vee}$ corresponding to $x \mapsto -x$. Section 3 discusses convolution at length. Three techniques are used—the realization of distributions of compact support in terms of derivatives of complex measures, an interchange-of-limits result for differentiation in one variable and integration in another, and a device for localizing general distributions to distributions of compact support.

Section 4 reviews the operation of the Fourier transform on tempered distributions; this was introduced in Chapter III. The two main results are that the Fourier transform of a distribution of compact support is a smooth function whose derivatives have at most polynomial growth and that the convolution of a distribution of compact support and a tempered distribution is a tempered distribution whose Fourier transform is the product of the two Fourier transforms.

Section 5 establishes a fundamental solution for the Laplacian in \mathbb{R}^N for $N > 2$ and concludes with an existence theorem for distribution solutions to $\Delta u = f$ when f is any distribution of compact support.

1. Continuity on Spaces of Smooth Functions

Distributions are continuous linear functionals on vector spaces of smooth functions. Their properties are deceptively simple-looking and enormously helpful. Some of their power is hidden in various interchanges of limits that need to be

carried out to establish their basic properties. The result is a theory that is easy to implement and that yields results quickly. In the last section of this chapter, we shall see an example of this phenomenon when we show how it gives information about solutions of partial differential equations involving the Laplacian.

The three vector spaces of scalar-valued smooth functions that we shall consider in the text¹ of this chapter are $C^\infty(U)$, $\mathcal{S}(\mathbb{R}^N)$, and $C_{\text{com}}^\infty(U)$, where U is a nonempty open set in \mathbb{R}^N . Topologies for these spaces were introduced in Section IV.2, Section III.1, and Section IV.7, respectively. Let $\{K_p\}$ be an exhausting sequence of compact subsets of U , i.e., a sequence such that $K_p \subseteq K_{p+1}$ for all p and such that $U = \bigcup_{p=1}^\infty K_p$.

The vector space $C^\infty(U)$ of all smooth functions on U is given by a separating family of seminorms such that a countable subfamily suffices. The members of the subfamily may be taken to be $\|f\|_{p,\alpha} = \sup_{x \in K_p} |D^\alpha f(x)|$, where $1 \leq p < \infty$ and where α varies over all differentiation multi-indices.² The space of continuous linear functionals is denoted by $\mathcal{E}'(U)$, and the members of this space are called “distributions of compact support” for reasons that we recall in a moment.

The vector space $\mathcal{S}(\mathbb{R}^N)$ of all Schwartz functions is another space given by a separating family of seminorms such that a countable subfamily suffices. The members of the subfamily may be taken to be $\|f\|_{\alpha,\beta} = \sup_{x \in \mathbb{R}^N} |x^\alpha D^\beta f(x)|$, where α and β vary over all differentiation multi-indices.³ The space of continuous linear functionals is denoted by $\mathcal{S}'(\mathbb{R}^N)$, and the members of this space are called “tempered distributions.”

The vector space $C_{\text{com}}^\infty(U)$ of all smooth functions of compact support on U is given by the inductive limit topology obtained from the vector subspaces $C_{K_p}^\infty$. The space $C_{K_p}^\infty$ consists of the smooth functions with support contained in K_p , the topology on $C_{K_p}^\infty$ being given by the countable family of seminorms $\|f\|_{p,\alpha} = \sup_{x \in K_p} |D^\alpha f(x)|$. The space of continuous linear functionals is traditionally⁴ written $\mathcal{D}'(U)$, and the members of this space are called simply “distributions.” Since the field of scalars is a locally convex topological vector space, Proposition 4.29 shows that the members of $\mathcal{D}'(U)$ may be viewed as arbitrary sequences of consistently defined continuous linear functionals on the spaces $C_{K_p}^\infty$.

¹A fourth space, the space of periodic smooth functions on \mathbb{R}^N , is considered in Problems 12–19 at the end of the chapter and again in the problems at the end of Chapter VII.

²The notation for the seminorms in Chapter IV was chosen for the entire separating subfamily and amounted to $\|f\|_{K_p, D^\alpha}$. The subscripts have been simplified to take into account the nature of the countable subfamily.

³The notation for the seminorms in Chapter III was chosen for the entire separating subfamily and amounted to $\|f\|_{x^\alpha, x^\beta}$. The subscripts have been simplified to take into account the nature of the countable subfamily.

⁴The tradition dates back to Laurent Schwartz’s work, in which $\mathcal{D}(U)$ was the notation for $C_{\text{com}}^\infty(U)$ and $\mathcal{D}'(U)$ denoted the space of continuous linear functionals.

For the spaces of smooth functions, there are continuous inclusions

$$\begin{aligned} C_{\text{com}}^{\infty}(U) &\subseteq C^{\infty}(U) && \text{for all } U, \\ C_{\text{com}}^{\infty}(\mathbb{R}^N) &\subseteq \mathcal{S}(\mathbb{R}^N) \subseteq C^{\infty}(\mathbb{R}^N) && \text{for } U = \mathbb{R}^N. \end{aligned}$$

We observed in Section IV.2 that $C_{\text{com}}^{\infty}(U) \subseteq C^{\infty}(U)$ has dense image, and it follows that $\mathcal{S}(\mathbb{R}^N) \subseteq C^{\infty}(\mathbb{R}^N)$ has dense image. Proposition 4.12 showed that $C_{\text{com}}^{\infty}(\mathbb{R}^N) \subseteq \mathcal{S}(\mathbb{R}^N)$ has dense image.

If $i : A \rightarrow B$ denotes one of these inclusions and T is a continuous linear functional on B , then $T \circ i$ is a continuous linear functional on A , and we can regard $T \circ i$ as the restriction of T to A . Since i has dense image, $T \circ i$ cannot be 0 unless T is 0. Thus each restriction map $T \mapsto T \circ i$ as above is one-one. We therefore have *one-one* restriction maps

$$\begin{aligned} \mathcal{E}'(U) &\rightarrow \mathcal{D}'(U) && \text{for all } U, \\ \mathcal{E}'(\mathbb{R}^N) &\rightarrow \mathcal{S}'(\mathbb{R}^N) \rightarrow \mathcal{D}'(\mathbb{R}^N) && \text{for } U = \mathbb{R}^N. \end{aligned}$$

This fact justifies using the term “distribution” for any member of \mathcal{D}' and for using the term “distribution” with an appropriate modifier for members of \mathcal{E}' and \mathcal{S}' .

As in Section III.1 it will turn out often to be useful to write the effect of a distribution T on a function φ as $\langle T, \varphi \rangle$, rather than as $T(\varphi)$, and we shall adhere to this convention systematically for the moment.⁵

We introduced in Section IV.2 the notion of “support” for any member of $\mathcal{E}'(U)$, and we now extend that discussion to $\mathcal{D}'(U)$. We saw in Proposition 4.10 that if T is an arbitrary linear functional on $C_{\text{com}}^{\infty}(U)$ and if U' is the union of all open subsets U_{γ} of U such that T vanishes on $C_{\text{com}}^{\infty}(U_{\gamma})$, then T vanishes on $C_{\text{com}}^{\infty}(U')$. We accordingly define the **support** of any distribution to be the complement in U of the union of all open sets U_{γ} such that T vanishes on $C_{\text{com}}^{\infty}(U_{\gamma})$. If T has empty support, then $T = 0$ because T vanishes on $C_{\text{com}}^{\infty}(U)$ and because $C_{\text{com}}^{\infty}(U)$ is dense in the domain of T . Proposition 4.11 showed that the members of $\mathcal{E}'(U)$ have compact support in this sense; we shall see in Theorem 5.1 that no other members of $\mathcal{D}'(U)$ have compact support.

An example of a member of $\mathcal{E}'(U)$ was given in Section IV.2: Take finitely many complex Borel measures ρ_{α} of compact support within U , the indexing being by multi-indices α with $|\alpha| \leq m$, and put $\langle T, \varphi \rangle = \sum_{|\alpha| \leq m} \int_U D^{\alpha} \varphi(x) d\rho_{\alpha}(x)$. Then T is in $\mathcal{E}'(U)$, and the support of T is contained in the union of the supports of the ρ_{α} 's. Theorem 5.1 below gives a converse, but it is necessary in general to allow the ρ_{α} 's to have support a little larger than the support of the given distribution T .

⁵A different convention is to write $\int_U \varphi(x) dT(x)$ in place of $\langle T, \varphi \rangle$. This notation emphasizes an analogy between distributions and measures and is especially useful when more than one \mathbb{R}^N variable is in play. This convention will provide helpful motivation in one spot in Section 3.

Theorem 5.1. If T is a member of $\mathcal{D}'(U)$ with support contained in a compact subset K of U , then T is in $\mathcal{E}'(U)$. Moreover, if K' is any compact subset of U whose interior contains K , then there exist a positive integer m and, for each multi-index α with $|\alpha| \leq m$, a complex Borel measure ρ_α supported in K' such that

$$\langle T, \varphi \rangle = \sum_{|\alpha| \leq m} \int_{K'} D^\alpha \varphi d\rho_\alpha \quad \text{for all } \varphi \in C^\infty(U).$$

REMARK. Problems 8–10 at the end of the chapter discuss the question of taking $K' = K$ under additional hypotheses.

PROOF. Let ψ be a member of $C_{\text{com}}^\infty(U)$ with values in $[0, 1]$ that is 1 on a neighborhood of K and is 0 on K'^c ; such a function exists by Proposition 3.5f. If φ is in $C_{\text{com}}^\infty(U)$, then we can write $\varphi = \psi\varphi + (1 - \psi)\varphi$ with $\psi\varphi$ in $C_{K'}^\infty$ and with $(1 - \psi)\varphi$ in $C_{\text{com}}^\infty(K^c)$. The assumption about the support of T makes $\langle T, (1 - \psi)\varphi \rangle = 0$, and therefore

$$\langle T, \varphi \rangle = \langle T, \psi\varphi \rangle + \langle T, (1 - \psi)\varphi \rangle = \langle T, \psi\varphi \rangle \quad \text{for all } \varphi \text{ in } C_{\text{com}}^\infty(U). \quad (*)$$

Since the inclusion $C_{K'}^\infty \rightarrow C_{\text{com}}^\infty(U)$ is continuous, we can define a continuous linear functional T_1 on $C_{K'}^\infty$ by $T_1(\phi) = \langle T, \phi \rangle$ for ϕ in $C_{K'}^\infty$. For any φ in $C_{\text{com}}^\infty(U)$, $\phi = \psi\varphi$ is in $C_{K'}^\infty$, and (*) gives $\langle T, \varphi \rangle = \langle T, \psi\varphi \rangle = T_1(\psi\varphi)$. The continuity of T_1 on $C_{K'}^\infty$ means that there exist m and C such that

$$|T_1(\phi)| \leq C \sum_{|\alpha| \leq m} \sup_{x \in K'} |D^\alpha \phi(x)| \quad \text{for all } \phi \in C_{K'}^\infty. \quad (**)$$

Let M be the number of multi-indices α with $|\alpha| \leq m$.

We introduce the Banach space X of M -tuples of continuous complex-valued functions on K' , the norm for X being the largest of the norms of the components. The Banach-space dual of this space is the space of M -tuples of continuous linear functionals on the components, thus the space of M -tuples of complex Borel measures on K' .

We can embed $C_{K'}^\infty$ as a vector subspace of X by mapping ϕ to the M -tuple with components $D^\alpha \phi$ for $|\alpha| \leq m$. We transfer T_1 from $C_{K'}^\infty$ to its image subspace within X , and the result, which we still call T_1 , is a linear functional continuous relative to the norm on X as a consequence of (**). Applying the Hahn–Banach Theorem, we extend T_1 to a continuous linear functional \tilde{T}_1 on all of X without an increase in norm. Then \tilde{T}_1 is given on X by an M -tuple of complex Borel measures ρ'_α on K' , i.e., $\tilde{T}_1(\{f_\alpha\}_{|\alpha| \leq m}) = \sum_{|\alpha| \leq m} \int_{K'} f_\alpha d\rho'_\alpha$. Therefore any φ in $C_{\text{com}}^\infty(U)$ has

$$\langle T, \varphi \rangle = T_1(\psi\varphi) = \tilde{T}_1(\{D^\alpha(\psi\varphi)\}_{|\alpha| \leq m}) = \sum_{|\alpha| \leq m} \int_{K'} D^\alpha(\psi\varphi) d\rho'_\alpha. \quad (\dagger)$$

The right side of (\dagger) is continuous on $C^\infty(U)$, and therefore T extends to a member of $\mathcal{E}'(U)$. The formula in the theorem follows by expanding out each $D^\alpha(\psi\varphi)$ in (\dagger) by the Leibniz rule for differentiation of products, grouping the derivatives of ψ with the complex measures, and reassembling the expression with new complex measures ρ_α . \square

In Chapters VII and VIII we shall be interested also in a notion related to support, namely the notion of “singular support.” If f is a locally integrable function on the open set U , then f defines a member T_f of $\mathcal{D}'(U)$ by

$$\langle T_f, \varphi \rangle = \int_U f \varphi dx \quad \text{for } \varphi \in C_{\text{com}}^\infty(U).$$

If U' is an open subset of U and T is a distribution on U , we say that T **equals a locally integrable function** on U' if there is some locally integrable function f on U' such that $\langle T, \varphi \rangle = \langle T_f, \varphi \rangle$ for all φ in $C_{\text{com}}^\infty(U)$. We say that T **equals a smooth function** on U' if this condition is satisfied for some f in $C^\infty(U')$. In the latter case the member of $C^\infty(U')$ is certainly unique.

The **singular support** of a member T of $\mathcal{D}'(U)$ is the complement of the union of all open subsets U' of U such that T equals a smooth function on U' . The uniqueness of the smooth function on such a subset implies that if T equals the smooth function f_1 on U'_1 and equals the smooth function f_2 on U'_2 , then $f_1(x) = f_2(x)$ for x in $U'_1 \cap U'_2$. In fact, T equals the smooth function $f_1|_{U'_1 \cap U'_2}$ on $U'_1 \cap U'_2$ and also equals the smooth function $f_2|_{U'_1 \cap U'_2}$ there. The uniqueness forces $f_1|_{U'_1 \cap U'_2} = f_2|_{U'_1 \cap U'_2}$. Taking the union of all the open subsets on which T equals a smooth function, we see that T is a smooth function on the complement of its singular support.

EXAMPLE. Take $U = \mathbb{R}^1$, and define

$$\langle T, \varphi \rangle = \lim_{\varepsilon \downarrow 0} \int_{|x| \geq \varepsilon} \frac{\varphi(x) dx}{x} \quad \text{for } \varphi \in C_{\text{com}}^\infty(\mathbb{R}^1).$$

To see that this is well defined, we choose η in $C_{\text{com}}^\infty(\mathbb{R}^1)$ with η identically 1 on the support of φ and with $\eta(x) = \eta(-x)$ for all x . Taylor's Theorem gives $\varphi(x) = \varphi(0) + xR(x)$ with R in $C^\infty(\mathbb{R}^1)$. Multiplying by $\eta(x)$ and integrating for $|x| \geq \varepsilon$, we obtain

$$\int_{|x| \geq \varepsilon} \frac{\varphi(x) dx}{x} = \varphi(0) \int_{|x| \geq \varepsilon} \frac{\eta(x) dx}{x} + \int_{|x| \geq \varepsilon} R(x) \eta(x) dx.$$

The first term on the right side is 0 for every ε , and therefore

$$\langle T, \varphi \rangle = \int_{\mathbb{R}^1} R(x) \eta(x) dx.$$

It follows that T is in $\mathcal{D}'(\mathbb{R}^1)$. On any function compactly supported in $\mathbb{R}^1 - \{0\}$, the original integral defining T is convergent. Thus T equals the function $1/x$ on $\mathbb{R}^1 - \{0\}$. Since $1/x$ is nowhere zero on $\mathbb{R}^1 - \{0\}$, the (ordinary) support of T has to be a closed subset of \mathbb{R}^1 containing $\mathbb{R}^1 - \{0\}$. Therefore T has support \mathbb{R}^1 . On the other hand, T does not equal a function on all of \mathbb{R}^1 , and T has $\{0\}$ as its singular support.

Starting in Section 2, we shall examine various operations on distributions. Operations on distributions will be defined by duality from corresponding operations on smooth functions. For that reason it is helpful to know about continuity of various operations on spaces of smooth functions. These we study now.

We begin with multiplication by smooth functions and with differentiation. If ψ is in $C^\infty(U)$, then multiplication $\varphi \mapsto \psi\varphi$ carries $C_{\text{com}}^\infty(U)$ into itself and also $C^\infty(U)$ into itself. The same is true of any iterated partial derivative operator $\varphi \mapsto D^\alpha\varphi$. We shall show that these operations are continuous. A multiplication $\varphi \mapsto \psi\varphi$ need not carry $\mathcal{S}(\mathbb{R}^N)$ into itself, and we put aside $\mathcal{S}(\mathbb{R}^N)$ for further consideration later.

The kind of continuity result for $C^\infty(U)$ that we are studying tends to follow from an easy computation with seminorms, and it is often true that the same argument can be used to handle also $C_{\text{com}}^\infty(U)$. Here is the general fact.

Lemma 5.2. Suppose that $L : C^\infty(U) \rightarrow C^\infty(U)$ is a continuous linear map that carries $C_{\text{com}}^\infty(U)$ into $C_{\text{com}}^\infty(U)$ in such a way that for each compact $K \subseteq U$, C_K^∞ is carried into $C_{K'}^\infty$ for some compact $K' \supseteq K$. Then L is continuous as a linear map from $C_{\text{com}}^\infty(U)$ into $C_{\text{com}}^\infty(U)$.

PROOF. Proposition 4.29b shows that it is enough to prove for each K that the composition of $L : C_K^\infty \rightarrow C_{K'}^\infty$ followed by the inclusion of $C_{K'}^\infty$ into $C_{\text{com}}^\infty(U)$ is continuous, and we know that the inclusion is continuous. Fix K , choose K_p in the exhausting sequence containing the corresponding K' , and let α be a multi-index. By the continuity of $L : C^\infty(U) \rightarrow C^\infty(U)$, there exist a constant C , some integer q with $q \geq p$, and finitely many multi-indices β_i such that $\|L(\varphi)\|_{p,\alpha} \leq C \sum_i \|\varphi\|_{q,\beta_i}$. Since $L(\varphi)$ has support in $K' \subseteq K_p$ and φ has support in $K \subseteq K' \subseteq K_p \subseteq K_q$, this inequality shows that $\sup_{x \in K'} |D^\alpha(L(\varphi))(x)| \leq C \sum_i \sup_{x \in K} |D^{\beta_i}\varphi(x)|$. Hence $L : C_K^\infty \rightarrow C_{K'}^\infty$ is continuous, and the lemma follows. \square

Proposition 5.3. If ψ is in $C^\infty(U)$, then $\varphi \mapsto \psi\varphi$ is continuous from $C^\infty(U)$ to $C^\infty(U)$ and from $C_{\text{com}}^\infty(U)$ to $C_{\text{com}}^\infty(U)$. If α is any differentiation multi-index, then $\varphi \mapsto D^\alpha\varphi$ is continuous from $C^\infty(U)$ to $C^\infty(U)$ and from $C_{\text{com}}^\infty(U)$ to $C_{\text{com}}^\infty(U)$.

PROOF. The Leibniz rule for differentiation of products gives $D^\alpha(\psi\varphi) = \sum_{\beta \leq \alpha} c_\beta(D^{\beta-\alpha}\psi)(D^\beta\varphi)$ for certain integers c_β . Then

$$\|\psi\varphi\|_{p,\alpha} \leq \sum_{\beta \leq \alpha} c_\beta m_\beta \|\varphi\|_{p,\beta},$$

where $m_\beta = \sup_{x \in K_p} |D^{\beta-\alpha}\psi(x)|$, and it follows that $\varphi \mapsto \psi\varphi$ is continuous from $C^\infty(U)$ into itself. Taking $K' = K$ in Lemma 5.2, we see that $\varphi \mapsto \psi\varphi$ is continuous from $C_{\text{com}}^\infty(U)$ into itself.

Since $\|D^\alpha\varphi\|_{p,\beta} = \|\varphi\|_{p,\alpha+\beta}$, the function $\varphi \mapsto D^\alpha\varphi$ is continuous from $C^\infty(U)$ into itself, and Lemma 5.2 with $K' = K$ shows that $\varphi \mapsto D^\alpha\varphi$ is continuous from $C_{\text{com}}^\infty(U)$ into itself. \square

We can combine these two operations into the operation of a **linear partial differential operator**

$$P(x, D) = \sum_{|\alpha| \leq m} c_\alpha(x) D^\alpha \quad \text{with all } c_\alpha \text{ in } C^\infty(U)$$

by means of the formula $P(x, D)\varphi = \sum_{|\alpha| \leq m} c_\alpha(x) D^\alpha\varphi$. It is to be understood that the operator has smooth coefficients. It is immediate from Proposition 5.3 that $P(x, D)$ is continuous from $C^\infty(U)$ into itself and from $C_{\text{com}}^\infty(U)$ into itself.

An operator $P(x, D)$ as above is said to be of **order** m if some $c_\alpha(x)$ with $|\alpha| = m$ has c_α not identically 0. The operator reduces to an operator of the form $P(D)$ if the coefficient functions c_α are all constant functions.

We introduce the **transpose operator** $P(x, D)^{\text{tr}}$ by the formula

$$P(x, D)^{\text{tr}}\varphi(x) = \sum_{|\alpha| \leq m} (-1)^{|\alpha|} D^\alpha(c_\alpha(x)\varphi(x)).$$

Expanding out the terms $D^\alpha(c_\alpha(x)\varphi(x))$ by means of the Leibniz rule, we see that $P(x, D)^{\text{tr}}$ is some linear partial differential operator of the form $Q(x, D)$. The next proposition gives the crucial property of the transpose operator.

Proposition 5.4. Suppose that $P(x, D)$ is a linear partial differential operator on U . If u and v are in $C^\infty(U)$ and at least one of them is in $C_{\text{com}}^\infty(U)$, then

$$\int_U (P(x, D)^{\text{tr}}u(x))v(x) dx = \int_U u(x)(P(x, D)v(x)) dx.$$

PROOF. It is enough to prove that the partial derivative operator D_j with respect to x_j satisfies $\int_U (D_j u)v dx = -\int_U u(D_j v) dx$ since iteration of this formula gives the result of the proposition. Moving everything to one side of the equation

and putting $w = uv$, we see that it is enough to prove that $\int_{\mathbb{R}^N} I_U D_j w \, dx = 0$ if w is in $C_{\text{com}}^\infty(U)$, where I_U is the indicator function of U . We drop the I_U from the integration since $D_j w$ is 0 off U , and thus it is enough to prove that $\int_{\mathbb{R}^N} D_j w \, dx = 0$ for w in $C_{\text{com}}^\infty(\mathbb{R}^N)$. By Fubini's Theorem the integral may be computed as an iterated integral. The integral on the inside extends over the set where x_j is arbitrary in \mathbb{R} and the other variables take on particular values, say $x_i = c_i$ for $i \neq j$. The integral on the outside extends over all choices of the c_i for $i \neq j$. The inside integral is already 0, because for suitable a and b , it is of the form $\int_a^b D_j w \, dx_j = [w]_{x_j=a}^{x_j=b} = 0 - 0 = 0$. \square

Next let us consider convolution, taking $U = \mathbb{R}^N$. We shall be interested in the function $\psi * \varphi$ given by

$$\psi * \varphi(x) = \int_{\mathbb{R}^N} \psi(x-y)\varphi(y) \, dy = \int_{\mathbb{R}^N} \psi(y)\varphi(x-y) \, dy,$$

under the assumption that ψ and φ are in $C^\infty(\mathbb{R}^N)$ and that one of them has compact support.

A simple device of localization helps with the analysis of this function: If K is the support of ψ , then the values of $\psi * \varphi(x)$ for x in a bounded open set S depend only on the value of φ on the bounded open set of differences $S - K$. Consequently we can replace φ by $\eta\varphi$, where η is a member of $C_{\text{com}}^\infty(\mathbb{R}^N)$ that is 1 on $S - K$, and the values of $\psi * \varphi(x)$ will match those of $\psi * (\eta\varphi)(x)$ for x in S . The latter function is the convolution of two smooth functions of compact support and is smooth by Proposition 3.5c. Therefore $\psi * \varphi$ is always in $C^\infty(\mathbb{R}^N)$ if ψ is in $C_{\text{com}}^\infty(\mathbb{R}^N)$ and φ is in $C^\infty(\mathbb{R}^N)$. We shall use this same device later in treating convolution of distributions.

Proposition 5.5. If ψ is in $C_{\text{com}}^\infty(\mathbb{R}^N)$ and φ is in $C^\infty(\mathbb{R}^N)$, then

- (a) $D^\alpha(\psi * \varphi) = (D^\alpha\psi) * \varphi = \psi * (D^\alpha\varphi)$,
- (b) convolution of three functions in $C^\infty(\mathbb{R}^N)$ is associative when at least two of the three functions have compact support,
- (c) convolution with ψ is continuous from $C^\infty(\mathbb{R}^N)$ into itself and from $C_{\text{com}}^\infty(\mathbb{R}^N)$ into itself,
- (d) convolution with φ is continuous from $C_{\text{com}}^\infty(\mathbb{R}^N)$ into $C^\infty(\mathbb{R}^N)$.

PROOF. For (a), let K be the support of ψ . Concentrating on x 's lying in a bounded open set S , choose a function η in $C_{\text{com}}^\infty(\mathbb{R}^N)$ that is 1 on $S - K$, and then $\psi * \varphi(x) = \psi * (\eta\varphi)(x)$ for x in S . Proposition 3.5c says that

$$D^\alpha(\psi * (\eta\varphi))(x) = (D^\alpha\psi) * (\eta\varphi)(x) = \psi * D^\alpha(\eta\varphi)(x)$$

for all x in \mathbb{R}^N , and consequently

$$D^\alpha(\psi * \varphi)(x) = (D^\alpha\psi) * \varphi(x) = \psi * D^\alpha\varphi(x)$$

for all x in S . Since S is arbitrary, (a) follows. The proof of (b) is similar.

For (c), again let K be the support of ψ , and apply (a). Then

$$\begin{aligned} \|\psi * \varphi\|_{p,\alpha} &= \sup_{x \in K_p} |D^\alpha(\psi * \varphi)(x)| = \sup_{x \in K_p} |\psi * (D^\alpha \varphi)(x)| \\ &\leq \sup_{x \in K_p} \int_K |\psi(y)| |D^\alpha \varphi(x - y)| dy \leq \|\psi\|_1 \sup_{z \in K_p - K} |D^\alpha \varphi(z)|, \end{aligned}$$

and the right side is $\leq \|\psi\|_1 \|\varphi\|_{q,\alpha}$ if q is large enough so that $K_p - K \subseteq K_q$. This proves the continuity on $C^\infty(\mathbb{R}^N)$, and the continuity on $C_{\text{com}}^\infty(\mathbb{R}^N)$ then follows from Lemma 5.2.

For (d), Proposition 4.29b shows that it is enough to prove that $\psi \mapsto \psi * \varphi$ is continuous from C_K^∞ into $C^\infty(\mathbb{R}^N)$ for each compact set K . The same estimate as for (c) gives

$$\|\psi * \varphi\|_{p,\alpha} \leq \|\psi\|_1 \|\varphi\|_{q,\alpha} \leq |K| \|\varphi\|_{q,\alpha} (\sup_{x \in K} |\psi(x)|)$$

if q is large enough so that $K_p - K \subseteq K_q$. The result follows. \square

2. Elementary Operations on Distributions

In this section we take up operations on distributions. If f is a locally integrable function on the open set U , we defined the member T_f of $\mathcal{D}'(U)$ by

$$\langle T_f, \varphi \rangle = \int_U f \varphi dx$$

for φ in $C_{\text{com}}^\infty(U)$. If f vanishes outside a compact subset of U , then T_f is in $\mathcal{E}'(U)$, extending to operate on all of $C^\infty(U)$ by the same formula.

Starting from certain continuous operations L on smooth functions, we want to extend these operations to operations on distributions. So that we can regard L as an extension from smooth functions to distributions, we insist on having $L(T_f) = T_{L(f)}$ if f is smooth. To tie the definition of L on distributions T_f to the definition on general distributions T , we insist that L be the “transpose” of some continuous operation M on functions, i.e., that $\langle L(T), \varphi \rangle = \langle T, M(\varphi) \rangle$. Taking $T = T_f$ in this equation, we see that we must have $\int_U L(f) \varphi dx = \int_U f M(\varphi) dx$. On the other hand, once we have found a continuous M on smooth functions with $\int_U L(f) \varphi dx = \int_U f M(\varphi) dx$, then we can make the definition $\langle L(T), \varphi \rangle = \langle T, M(\varphi) \rangle$ for the effect of L on distributions. In particular the operator M on smooth functions is unique if it exists. We write $L^{\text{tr}} = M$ for it. In summary, our

procedure⁶ is to find, if we can, a continuous operator L^{tr} on smooth functions such that

$$\int_U L(f)\varphi \, dx = \int_U fL^{\text{tr}}(\varphi) \, dx$$

and then to define

$$\langle L(T), \varphi \rangle = \langle T, L^{\text{tr}}(\varphi) \rangle.$$

We begin with the operations of multiplication, whose continuity is addressed in Proposition 5.3. If L is multiplication by the function ψ in $C^\infty(U)$, then we can take $L^{\text{tr}} = L$ because $\int_U L(f)\varphi \, dx = \int_U (\psi f)\varphi \, dx = \int_U f(\psi\varphi) \, dx = \int_U fL^{\text{tr}}(\varphi)$ if f and φ are in $C^\infty(U)$ and one of them has compact support. Thus our definition of multiplication of a distribution T by ψ in $C^\infty(U)$ is

$$\langle \psi T, \varphi \rangle = \langle T, \psi\varphi \rangle.$$

Here we assume either that T is in $\mathcal{D}'(U)$ and φ is in $C_{\text{com}}^\infty(U)$ or else that T is in $\mathcal{E}'(U)$ and φ is in $C^\infty(U)$. Briefly we say that at least one of T and φ has compact support.

The operation of multiplication by a function can be used to localize the effect of a distribution in a way that is useful in the definition below of convolution of distributions. First observe that if T is in $\mathcal{D}'(U)$ and η is in $C_{\text{com}}^\infty(U)$, then the support of ηT is contained in the support of η ; in fact, if φ is any member of $C_{\text{com}}^\infty(U \cap \text{support}(\eta)^c)$, then $\eta\varphi = 0$ and hence $\langle \eta T, \varphi \rangle = \langle T, \eta\varphi \rangle = 0$. In particular, ηT is in $\mathcal{E}'(U)$. On the other hand, we lose no information about T by this operation if we allow all possible η 's, because if T is in $\mathcal{D}'(U)$ and if φ is a member of $C_{\text{com}}^\infty(U)$ with support in a compact subset K of U , then $\varphi = \eta\varphi$ and hence $\langle T, \varphi \rangle = \langle T, \eta\varphi \rangle = \langle \eta T, \varphi \rangle$.

Next we consider differentiation, which is a continuous operation by Proposition 5.3. When L gives the iterated derivative D^α of a distribution, we can take the operation L^{tr} on smooth functions to be $(-1)^{|\alpha|}$ times D^α . The definition is then

$$\langle D^\alpha T, \varphi \rangle = (-1)^{|\alpha|} \langle T, D^\alpha \varphi \rangle.$$

Again we assume that at least one of T and φ has compact support.

Putting these definitions together yields the definition of the operation of a linear partial differential operator $P(x, D)$ with smooth coefficients on distributions. The formula is

$$\langle P(x, D)T, \varphi \rangle = \langle T, P(x, D)^{\text{tr}}\varphi \rangle,$$

⁶Another way of proceeding is to use topologies on $\mathcal{E}'(U)$ and $\mathcal{D}'(U)$ such that $C_{\text{com}}^\infty(U)$ is dense in $\mathcal{E}'(U)$ and $C^\infty(U)$ is dense in $\mathcal{D}'(U)$. The approach in the text avoids the use of such topologies on spaces of distributions, and it will not be necessary to consider them.

where $P(x, D)^{\text{tr}}$ is the transpose differential operator defined in Section 1. This definition is forced to satisfy $P(x, D)T = T_{P(x, D)f}$ on smooth f .

For further operations let us specialize to the setting that $U = \mathbb{R}^N$. The first is the operation of acting by -1 in the domain. For a function φ , we define $\varphi^\vee(x) = \varphi(-x)$. It is easy to check that this operation is continuous on $C^\infty(\mathbb{R}^N)$ and on $C_{\text{com}}^\infty(\mathbb{R}^N)$. Since $\int_{\mathbb{R}^N} f^\vee \varphi dx = \int_{\mathbb{R}^N} f \varphi^\vee dx$ by a change of variables, the operator L^{tr} corresponding to $L(f) = f^\vee$ is just L itself. Thus the corresponding operation $T \mapsto T^\vee$ on distributions is given by

$$\langle T^\vee, \varphi \rangle = \langle T, \varphi^\vee \rangle.$$

The operation $(\cdot)^\vee$ has the further property that $(\varphi^\vee)^\vee = \varphi$ and $(T^\vee)^\vee = T$.

3. Convolution of Distributions

The next operation, again in the setting of \mathbb{R}^N , is the convolution of two distributions. Convolution is considerably more complicated than the operations considered so far because it involves two variables.

The method of Section 2 starts off easily enough. An easy change of variables shows that any three smooth functions, two of which have compact support, satisfy $\int_{\mathbb{R}^N} (\psi * f)\varphi dx = \int_{\mathbb{R}^N} (\psi)(f^\vee * \varphi) dx$, where $f^\vee(-x) = f(-x)$. This means that $\int_{\mathbb{R}^N} L(\psi)\varphi dx = \int_{\mathbb{R}^N} \psi L^{\text{tr}}(\varphi) dx$, where $L(\psi) = \psi * f$ and $L^{\text{tr}}(\varphi) = f^\vee * \varphi$. Thus Section 2 says to define $T * f$ by $\langle T * f, \varphi \rangle = \langle T, f^\vee * \varphi \rangle$. To handle the other convolution variable, however, we have to know that $T * f$ is a smooth function and that the passage from f to $T * f$ is continuous, and neither of these facts is immediately apparent. In addition, there are several cases to handle, depending on which two of the functions f , ψ , and φ at the start have compact support.

Sorting out all these matters could be fairly tedious, but there is a model for what happens that will help us anticipate the results. We shall follow the path that the model suggests. Then afterward, if we were to want to do so, it would be possible to go back and see that all the arguments with transposes in the style of Section 2 can be carried through with the tools that we have had to establish anyway.

The model takes a cue from Theorem 5.1, which says that members of $\mathcal{E}'(\mathbb{R}^N)$ are given by integration with compactly supported complex Borel measures and derivatives of them. In particular our definitions ought to specialize to familiar constructions when they are given by compactly supported positive Borel measures. In the case of measures, convolution is discussed in Problem 5 of Chapter VIII of *Basic*. The definition and results are as follows:

- (i) $(\mu_1 * \mu_2)(E) = \int_{\mathbb{R}^N} \mu_1(E - x) d\mu_2(x)$ by definition,
- (ii) $\int_{\mathbb{R}^N} \varphi d(\mu_1 * \mu_2) = \int_{\mathbb{R}^N} \int_{\mathbb{R}^N} \varphi(x + y) d\mu_1(x) d\mu_2(y)$ for $\varphi \in C_{\text{com}}(\mathbb{R}^N)$,

- (iii) $\mu_1 * \mu_2 = \mu_2 * \mu_1$,
 (iv) $\varphi dx * \mu$ is the continuous function $(\varphi dx * \mu)(x) = \int_{\mathbb{R}^N} \varphi(x-y) d\mu(y) = \int_{\mathbb{R}^N} (\varphi^\vee)_{-x} d\mu$ for $\varphi \in C_{\text{com}}(\mathbb{R}^N)$, where the subscript $-x$ refers to the translate $h_t(y) = h(y+t)$.

The measures and the function φ in these properties are all assumed compactly supported, but some relaxation of this condition is permissible. For example the function φ can be allowed to be any continuous scalar-valued function on \mathbb{R}^N .

In defining convolution of distributions and establishing its properties, we shall face three kinds of technical problems: One is akin to Fubini's Theorem and will be handled for $\mathcal{E}'(\mathbb{R}^N)$ by appealing to Theorem 5.1 and using the ordinary form of Fubini's Theorem with measures. A second is a regularity question—showing that certain integrations in one variable of functions of two variables lead to smooth functions of the remaining variable—and will be handled for $\mathcal{E}'(\mathbb{R}^N)$ by Lemma 5.6 below. A third is the need to work with $\mathcal{D}'(\mathbb{R}^N)$, not just $\mathcal{E}'(\mathbb{R}^N)$, and will be handled by the localization device $T \mapsto \eta T$ mentioned in Section 2. We begin with the lemma that addresses the regularity question.

Lemma 5.6. Let K be a compact metric space, and let μ be a Borel measure on K . Suppose that $\Phi = \Phi(x, y)$ is a scalar-valued function on $\mathbb{R}^N \times K$ such that $\Phi(\cdot, y)$ is smooth for each y in K , and suppose further that every iterated partial derivative $D_x^\alpha \Phi$ in the first variable is continuous on $\mathbb{R}^N \times K$. Then the function

$$F(x) = \int_K \Phi(x, y) d\mu(y)$$

is smooth on \mathbb{R}^N and satisfies $D^\alpha F(x) = \int_K D_x^\alpha \Phi(x, y) d\mu(y)$ for every multi-index α .

REMARKS. The lemma gives us a new proof of the smoothness shown in Section 1 for $\psi * \varphi$ when ψ is in $C_{\text{com}}^\infty(\mathbb{R}^N)$ and φ is in $C^\infty(\mathbb{R}^N)$. In fact, we write the convolution as $\psi * \varphi(x) = \int_{\mathbb{R}^N} \varphi(x-y)\psi(y) dy$ and apply the lemma with μ equal to Lebesgue measure on the compact set $\text{support}(\psi)$ and with $F(x) = \psi * \varphi(x)$ and $\Phi(x, y) = \varphi(x-y)\psi(y)$.

PROOF. In the proof we may assume without loss of generality that Φ is real-valued. We begin by showing that F is continuous. If $x_n \rightarrow x_0$, then the uniform continuity of Φ on the compact set $\{x_n\}_{n \geq 0} \times K$ implies that $\lim_n \Phi(x_n, y) = \Phi(x_0, y)$ uniformly. Dominated convergence allows us to conclude that $\lim_n \int_K \Phi(x_n, y) d\mu(y) = \int_K \Phi(x_0, y) d\mu(y)$. Therefore F is continuous.

Let B be a (large) closed ball in \mathbb{R}^N , and suppose that x is a member of B that is at distance at least 1 from B^c . If e_j denotes the j^{th} standard basis vector of \mathbb{R}^N

and if $|h| < 1$, then the Mean Value Theorem gives

$$\frac{\Phi(x + he_j, y) - \Phi(x, y)}{h} = \frac{\partial \Phi}{\partial x_j}(c, y)$$

for some c on the line segment between x and $x + h$. If $\epsilon > 0$ is given, choose the δ of uniform continuity of $\frac{\partial \Phi}{\partial x_j}$ on the compact set $B \times K$. We may assume that $\delta < 1$. For $|h| < \delta$ and for y in K , we have

$$\left| \frac{\Phi(x + he_j, y) - \Phi(x, y)}{h} - \frac{\partial \Phi}{\partial x_j}(x, y) \right| = \left| \frac{\partial \Phi}{\partial x_j}(c, y) - \frac{\partial \Phi}{\partial x_j}(x, y) \right| < \epsilon,$$

the inequality holding since (c, y) and (x, y) are both in $B \times K$ and are at distance at most δ from one another. As a consequence, if L is any compact subset of \mathbb{R}^N , then

$$\lim_{h \rightarrow 0} \frac{\Phi(x + he_j, y) - \Phi(x, y)}{h} = \frac{\partial \Phi}{\partial x_j}(x, y)$$

uniformly for (x, y) in $L \times K$. Because of this uniform convergence we have

$$\lim_{h \rightarrow 0} \int_K \frac{\Phi(x + he_j, y) - \Phi(x, y)}{h} d\mu(y) = \int_K \frac{\partial \Phi}{\partial x_j}(x, y) d\mu(y).$$

The integral on the left side equals $h^{-1}[F(x + he_j, y) - F(x, y)]$, and the limit relation therefore shows that $\frac{\partial}{\partial x_j} \int_K \Phi(x, y) d\mu(y)$ exists and equals $\int_K \frac{\partial \Phi}{\partial x_j}(x, y) d\mu(y)$.

This establishes the formula $D^\alpha F(x) = \int_K D_x^\alpha \Phi(x, y) d\mu(y)$ for α equal to the multi-index that is 1 in the j^{th} place and 0 elsewhere. The remainder of the proof makes the above argument into an induction. If we have established the formula $D^\alpha F(x) = \int_K D_x^\alpha \Phi(x, y) d\mu(y)$ for a certain α , then the first paragraph of the proof shows that $D^\alpha F$ is continuous. The second paragraph of the proof shows for each partial derivative operator D_j in one of the x variables that the operator $D^\beta = D_j D^\alpha$ has $D^\beta F(x) = \int_K D_x^\beta \Phi(x, y) d\mu(y)$. The lemma follows. \square

For our definitions let us begin with the convolution of two members of $\mathcal{E}'(\mathbb{R}^N)$. As indicated at the start of the section, we shall jump right to the final formula. The justification via formulas for transpose operations can be done afterward if desired. If we use notation that treats distributions like measures, the formula (ii) above suggests trying

$$\langle S * T, \varphi \rangle = \int_{\mathbb{R}^N} \int_{\mathbb{R}^N} \varphi(x + y) dT(y) dS(x) = \langle S, \langle T, \varphi_x \rangle \rangle = \langle T, \langle S, \varphi_y \rangle \rangle,$$

where the subscript again indicates a translation: $\varphi_x(z) = \varphi(z + x)$. The outside distribution acts on the subscripted variable, and the inside distribution acts on the hidden variable. To make this into a rigorous definition, however, we have to check that $\langle T, \varphi_x \rangle$ and $\langle S, \varphi_y \rangle$ are smooth, that the last equality in the above display is valid, and that the resulting dependence on φ is continuous. We carry out these steps in the next proposition.

Proposition 5.7. Let S and T be in $\mathcal{E}'(\mathbb{R}^N)$, and let φ be in $C^\infty(\mathbb{R}^N)$. Then

- (a) the functions $x \mapsto \langle T, \varphi_x \rangle$ and $y \mapsto \langle S, \varphi_y \rangle$ are smooth on \mathbb{R}^N ,
- (b) $D^\alpha(x \mapsto \langle T, \varphi_x \rangle) = \langle T, (D^\alpha \varphi)_x \rangle$,
- (c) the function $\varphi \mapsto \langle T, \varphi_x \rangle$ is continuous from $C^\infty(\mathbb{R}^N)$ into itself and from $C_{\text{com}}^\infty(\mathbb{R}^N)$ into itself,
- (d) $\langle S, \langle T, \varphi_x \rangle \rangle = \langle T, \langle S, \varphi_y \rangle \rangle$,
- (e) the function $\varphi \mapsto \langle S, \langle T, \varphi_x \rangle \rangle$ is continuous from $C^\infty(\mathbb{R}^N)$ into the scalars,
- (f) the formula

$$\langle S * T, \varphi \rangle = \langle S, \langle T, \varphi_x \rangle \rangle = \langle T, \langle S, \varphi_y \rangle \rangle$$

determines a well-defined member of $\mathcal{E}'(\mathbb{R}^N)$ such that $S * T = T * S$,

- (g) the supports of S , T , and $S * T$ are related by

$$\text{support}(S * T) \subseteq \text{support}(S) + \text{support}(T).$$

PROOF. Let expressions for S and T in Theorem 5.1 be

$$\langle S, \varphi \rangle = \sum_\alpha \int_{\mathbb{R}^N} D^\alpha \varphi(x) d\rho_\alpha(x) \quad \text{and} \quad \langle T, \varphi \rangle = \sum_\beta \int_{\mathbb{R}^N} D^\beta \varphi(y) d\sigma_\beta(y),$$

the sums both being over finite sets of multi-indices and the complex measures being supported on some compact subset of \mathbb{R}^N . Then

$$\langle T, \varphi_x \rangle = \sum_\beta \int_{\mathbb{R}^N} D^\beta \varphi(x + y) d\sigma_\beta(y). \quad (*)$$

If we apply Lemma 5.6 with $\Phi(x, y) = D^\beta \varphi(x + y)$ and treat y as varying over the union of the compact supports of the σ_β 's, then we see that each term in the sum over β is a smooth function of x . Hence $x \mapsto \langle T, \varphi_x \rangle$ is smooth, and symmetrically $y \mapsto \langle S, \varphi_y \rangle$ is smooth. This proves (a).

Applying to (*) the conclusions of Lemma 5.6 about passing the derivative operator D^α under the integral sign, we obtain

$$D^\alpha(x \mapsto \langle T, \varphi_x \rangle) = \sum_\beta \int_{\mathbb{R}^N} D^{\alpha+\beta} \varphi(x + y) d\sigma_\beta(y) = \langle T, (D^\alpha \varphi)_x \rangle.$$

This proves (b).

If K denotes a subset of \mathbb{R}^N containing the supports of all the σ_β 's, then

$$|D^\alpha \langle T, \varphi_x \rangle| \leq \sum_\beta \sup_{y \in K} |D^{\alpha+\beta} \varphi(x + y)| \|\sigma_\beta\|,$$

where $\|\sigma_\beta\|$ denotes the total-variation norm of σ_β . Hence

$$\sup_{x \in L} |D^\alpha \langle T, \varphi_x \rangle| \leq \sum_{\beta} \sup_{z \in K+L} |D^{\alpha+\beta} \varphi(z)| \|\sigma_\beta\|.$$

This proves (c) for $C^\infty(\mathbb{R}^N)$. Combining this same inequality with Lemma 5.2, we obtain (c) for $C_{\text{com}}^\infty(\mathbb{R}^N)$.

The formula for $\langle S, \cdot \rangle$ and the identity (*) together give

$$\begin{aligned} \langle S, \langle T, \varphi_x \rangle \rangle &= \sum_{\alpha, \beta} \int_{\mathbb{R}^N} \int_{\mathbb{R}^N} D^\alpha D^\beta \varphi_x(y) d\sigma_\beta(y) d\rho_\alpha(x) \\ &= \sum_{\alpha, \beta} \int_{\mathbb{R}^N} \int_{\mathbb{R}^N} D^{\alpha+\beta} \varphi(x+y) d\sigma_\beta(y) d\rho_\alpha(x). \end{aligned} \quad (**)$$

By Fubini's Theorem the right side is equal to

$$\sum_{\alpha, \beta} \int_{\mathbb{R}^N} \int_{\mathbb{R}^N} D^{\alpha+\beta} \varphi(x+y) d\rho_\alpha(x) d\sigma_\beta(y) = \langle T, \langle S, \varphi_y \rangle \rangle.$$

This proves (d).

Conclusion (e) is immediate from (c) and the continuity of S on $C^\infty(\mathbb{R}^N)$. Thus $S * T$ is in $\mathcal{E}'(\mathbb{R}^N)$. The equality in (d) shows that $S * T = T * S$. This proves (f).

Finally let L be the compact set $\text{support}(S) + \text{support}(T)$, and suppose that φ is in $C_{\text{com}}^\infty(L^c)$. Let $d > 0$ be the distance from $\text{support}(\varphi)$ to L , and let D be the function giving the distance to a set. Define

$$L_S = \{x \mid D(x, \text{support}(S)) \leq \frac{1}{3}d\}$$

and
$$L_T = \{x \mid D(x, \text{support}(T)) \leq \frac{1}{3}d\}.$$

If x_S is in L_S and x_T is in L_T , then $|x_S - s| \leq \frac{1}{3}d$ and $|x_T - t| \leq \frac{1}{3}d$ for some s in $\text{support}(S)$ and t in $\text{support}(T)$. Thus $|(x_S + x_T) - (s + t)| \leq \frac{2}{3}d$. Hence $x_S + x_T$ is at distance $\leq \frac{2}{3}d$ from L . Since every member of $\text{support}(\varphi)$ is at distance $\geq d$ from L , $x_S + x_T$ is not in $\text{support}(\varphi)$. Therefore

$$(L_S + L_T) \cap \text{support}(\varphi) = \emptyset. \quad (\dagger)$$

Also, $\text{support}(S) \subseteq (L_S)^o$ and $\text{support}(T) \subseteq (L_T)^o$. Since L_S contains a neighborhood of $\text{support}(S)$, Theorem 5.1 allows us to express S in terms of complex Borel measures ρ_α supported in L_S . Similarly we can express T in terms of complex Borel measures σ_β supported in L_T . By (\dagger) the integrand in $(**)$ is identically 0 on $L_S + L_T$, and hence $\langle S, \langle T, \varphi_x \rangle \rangle = 0$. Thus $\langle S * T, \varphi \rangle = 0$ for all φ in $C_{\text{com}}^\infty(L^c)$, and we conclude that $\text{support}(S * T) \subseteq L = \text{support}(S) + \text{support}(T)$. This proves (g). \square

Proposition 5.7 establishes facts about the convolution of two members of $\mathcal{E}'(\mathbb{R}^N)$ as a member of $\mathcal{E}'(\mathbb{R}^N)$. If one of the two members is in fact a smooth function of compact support, then the corresponding results about convolution of measures suggest that the convolution should be a smooth function. The necessary tools for carrying out a proof are already in place in Proposition 5.7 and Theorem 5.1.

Corollary 5.8. If S is in $\mathcal{E}'(\mathbb{R}^N)$, f is in $C_{\text{com}}^\infty(\mathbb{R}^N)$, and φ is in $C^\infty(\mathbb{R}^N)$, then

$$\langle S * T_f, \varphi \rangle = \langle S, f^\vee * \varphi \rangle.$$

Moreover, $S * T_f$ is given by the C^∞ function $y \mapsto \langle S, (f^\vee)_{-y} \rangle$, i.e.,

$$S * T_f = T_F \quad \text{with } F(y) = \langle S, (f^\vee)_{-y} \rangle.$$

REMARKS. For S in $\mathcal{E}'(\mathbb{R}^N)$ and f in $C_{\text{com}}^\infty(\mathbb{R}^N)$, we write $S * f$ for the $C_{\text{com}}^\infty(\mathbb{R}^N)$ function F of the corollary such that $S * T_f = T_F$. The specific formula that we shall use to simplify notation is

$$S * T_f = T_{S*f},$$

with the right side written as T_{S*f} rather than T_{S*T_f} .

PROOF. Proposition 5.7f gives

$$\begin{aligned} \langle S * T_f, \varphi \rangle &= \langle S, \langle T_f, \varphi_x \rangle \rangle = \langle S, \int_{\mathbb{R}^N} f(y) \varphi(x+y) dy \rangle \\ &= \langle S, \int_{\mathbb{R}^N} f(-y) \varphi(x-y) dy \rangle = \langle S, f^\vee * \varphi \rangle. \end{aligned} \quad (*)$$

This proves the first displayed formula. For the rest let S be written according to Theorem 5.1 as $\langle S, \psi \rangle = \sum_\alpha \int_{\mathbb{R}^N} D^\alpha \psi d\rho_\alpha$. Then

$$\begin{aligned} \langle S, f^\vee * \varphi \rangle &= \sum_\alpha \int_{\mathbb{R}^N} D^\alpha (f^\vee * \varphi)(x) d\rho_\alpha(x) \\ &= \sum_\alpha \int_{\mathbb{R}^N} (D^\alpha f^\vee * \varphi)(x) d\rho_\alpha(x) \\ &= \sum_\alpha \int_{\mathbb{R}^N} \int_{\mathbb{R}^N} D^\alpha f^\vee(x-y) \varphi(y) dy d\rho_\alpha(x) \\ &= \int_{\mathbb{R}^N} \left[\sum_\alpha \int_{\mathbb{R}^N} (D^\alpha f^\vee)_{-y} d\rho_\alpha(x) \right] \varphi(y) dy \\ &= \int_{\mathbb{R}^N} \langle S, (f^\vee)_{-y} \rangle \varphi(y) dy, \end{aligned}$$

the next-to-last equality following from Fubini's Theorem. Combining this calculation with (*), we see that $S * T_f = T_F$ with $F(y) = \langle S, (f^\vee)_{-y} \rangle$. The function F is smooth by Proposition 5.7a. \square

Corollary 5.9. Convolution of members of $\mathcal{E}'(\mathbb{R}^N)$ is consistent with convolution of members of $C_{\text{com}}^\infty(\mathbb{R}^N)$ in the sense that if f and g are in $C_{\text{com}}^\infty(\mathbb{R}^N)$, then $T_g * T_f$ is given by the C^∞ function $T_g * f$, and this function equals $g * f$.

PROOF. The first conclusion is the result of Corollary 5.8 with $S = T_g$. For the second conclusion Corollary 5.8 gives $T_g * T_f = T_F$ with $F(y) = \langle T_g, (f^\vee)_{-y} \rangle = \int_{\mathbb{R}^N} g(x) f^\vee(x - y) dx = \int_{\mathbb{R}^N} g(x) f(y - x) dy = (g * f)(y)$. Hence $T_{T_g * f} = T_{g * f}$, and the second conclusion follows. \square

Corollary 5.10. If T is in $\mathcal{E}'(\mathbb{R}^N)$ and φ is in $C_{\text{com}}^\infty(\mathbb{R}^N)$, then

$$(T^\vee * \varphi)(x) = \langle T, \varphi_x \rangle.$$

PROOF. Corollary 5.8 gives $(T^\vee * \varphi)(x) = \langle T^\vee, (\varphi^\vee)_{-x} \rangle$, and the latter is equal to $\langle T, ((\varphi^\vee)_{-x})^\vee \rangle = \langle T, \varphi_x \rangle$. \square

Corollary 5.11. If S and T are in $\mathcal{E}'(\mathbb{R}^N)$ and φ is in $C_{\text{com}}^\infty(\mathbb{R}^N)$, then

$$\langle S * T, \varphi \rangle = \langle S, T^\vee * \varphi \rangle.$$

PROOF. Proposition 5.7f and Corollary 5.10 give $\langle S * T, \varphi \rangle = \langle S, \langle T, \varphi_x \rangle \rangle = \langle S, T^\vee * \varphi \rangle$. \square

Corollary 5.12. If T is in $\mathcal{E}'(\mathbb{R}^N)$, then the map $\varphi \mapsto T^\vee * \varphi$ is continuous from $C_{\text{com}}^\infty(\mathbb{R}^N)$ into itself and extends continuously to a map of $C^\infty(\mathbb{R}^N)$ into itself under the definition

$$(T^\vee * \varphi)(x) = \langle T, \varphi_x \rangle.$$

The derivatives of $T^\vee * \varphi$ satisfy $D^\alpha(T^\vee * \varphi) = T^\vee * D^\alpha \varphi$, and also $(T^\vee * \varphi)^\vee = T * \varphi^\vee$.

PROOF. The equality $(T^\vee * \varphi)(x) = \langle T, \varphi_x \rangle$ restates Corollary 5.10, and the statements about continuity follow from Proposition 5.7c. For the derivatives we use Proposition 5.7b to write $D^\alpha(T^\vee * \varphi)(x) = D^\alpha \langle T, \varphi_x \rangle = \langle T, (D^\alpha \varphi)_x \rangle = (T^\vee * D^\alpha \varphi)(x)$. Finally $(T^\vee * \varphi)^\vee(x) = (T^\vee * \varphi)(-x) = \langle T, \varphi_{-x} \rangle = \langle T^\vee, (\varphi_{-x})^\vee \rangle = \langle T^\vee, (\varphi^\vee)_x \rangle = (T * \varphi^\vee)(x)$. \square

Since $T^\vee * \varphi$ is now well defined for T in \mathcal{E}' and φ in $C^\infty(\mathbb{R}^N)$, we can use the same formula as in Corollary 5.11 to make a definition of convolution of two arbitrary distributions when only one of the two distributions being convolved has compact support. Specifically if S is in $\mathcal{D}'(\mathbb{R}^N)$ and T is in $\mathcal{E}'(\mathbb{R}^N)$, we define $S * T$ in $\mathcal{D}'(\mathbb{R}^N)$ by the first equality of

$$\langle S * T, \varphi \rangle = \langle S, T^\vee * \varphi \rangle = \langle S, \langle T, \varphi_x \rangle \rangle \quad \text{for } \varphi \in C_{\text{com}}^\infty(\mathbb{R}^N),$$

the second equality holding by Corollary 5.12. Corollary 5.12 shows also that $S * T$ has the necessary property of being continuous on $C_{\text{com}}^\infty(\mathbb{R}^N)$, and Corollary 5.11 shows that this definition extends the definition of $S * T$ when S and T are in $\mathcal{E}'(\mathbb{R}^N)$.

What is missing with this definition of $S * T$ is any additional relationship that arises for distributions that equal smooth functions. For example:

- Does this new definition make $T_f * T = T_{T*f}$ when T is compactly supported and f does not have compact support?
- Is $S * T_f$ equal to a function when f is compactly supported and S is not?
- If so, are the formulas of Corollaries 5.8, 5.9, and 5.10 valid?
- If so, can we equally well define $S * T$ by $\langle S * T, \varphi \rangle = \langle T, S^\vee * \varphi \rangle = \langle T, \langle S, \varphi_y \rangle \rangle$ when T is compactly supported and S is not?

The answers to these questions are all affirmative. To get at the proofs, we introduce a technique of localization for members of $\mathcal{D}'(\mathbb{R}^N)$. Proposition 5.13 below is a quantitative statement of what we need. We apply the technique to obtain smoothness of functions of the form $\langle S, \varphi_y \rangle$ when S is in $\mathcal{D}'(\mathbb{R}^N)$ and φ is in $C_{\text{com}}^\infty(\mathbb{R}^N)$; this step does not make use of the above enlarged definition of $S * T$. Then we gradually make the connection with the new definition of convolution and establish all the desired properties.

Proposition 5.13. Let N be a bounded open set in \mathbb{R}^N . Let S be in $\mathcal{D}'(\mathbb{R}^N)$, and let φ be in $C_{\text{com}}^\infty(\mathbb{R}^N)$. If $\eta \in C_{\text{com}}^\infty(\mathbb{R}^N)$ is identically 1 on the set of differences $\text{support}(\varphi) - N$, then $\langle S, \varphi_y \rangle = \langle \eta S, \varphi_y \rangle$ for y in N . Consequently $y \mapsto \langle S, \varphi_y \rangle$ is in $C^\infty(\mathbb{R}^N)$. Moreover, $D^\alpha(y \mapsto \langle S, \varphi_y \rangle) = \langle S, (D^\alpha \varphi)_y \rangle$, and the linear map $\varphi \mapsto \langle S, \varphi_y \rangle$ of $C_{\text{com}}^\infty(\mathbb{R}^N)$ into $C^\infty(\mathbb{R}^N)$ is continuous.

PROOF. Let y be in N . If $x + y$ is in $\text{support}(\varphi)$, then x is in $\text{support}(\varphi) - N$, and $\eta(x) = 1$. Hence $\eta(x)\varphi(x + y) = \varphi(x + y)$. If $x + y$ is not in $\text{support}(\varphi)$, then $\eta(x)\varphi(x + y) = \varphi(x + y)$ because both sides are 0. Hence $\eta\varphi_y = \varphi_y$ for y in N , and $\langle S, \varphi_y \rangle = \langle S, \eta\varphi_y \rangle = \langle \eta S, \varphi_y \rangle$. The function $y \mapsto \langle \eta S, \varphi_y \rangle$ is smooth by Proposition 5.7a, and hence $y \mapsto \langle S, \varphi_y \rangle$ is smooth on N . Since N is arbitrary, $y \mapsto \langle S, \varphi_y \rangle$ is smooth everywhere.

For the derivative formula Proposition 5.7b gives us $D^\alpha(y \mapsto \langle \eta S, \varphi_y \rangle) = \langle \eta S, (D^\alpha \varphi)_y \rangle$ for y in N . For y in N , $\langle \eta S, \varphi_y \rangle = \langle S, \varphi_y \rangle$ and $\langle \eta S, (D^\alpha \varphi)_y \rangle = \langle S, (D^\alpha \varphi)_y \rangle$. Therefore $D^\alpha(y \mapsto \langle S, \varphi_y \rangle) = \langle S, (D^\alpha \varphi)_y \rangle$ for y in N . Since N is arbitrary, $D^\alpha(y \mapsto \langle S, \varphi_y \rangle) = \langle S, (D^\alpha \varphi)_y \rangle$ everywhere.

For the asserted continuity of $\varphi \mapsto \langle S, \varphi_y \rangle$, it is enough to prove that this map carries C_K^∞ continuously into $C^\infty(\mathbb{R}^N)$ for each compact set K . If N is a bounded open set on which we are to make some C^∞ estimates, choose $\eta \in C_{\text{com}}^\infty(\mathbb{R}^N)$ so as to be identically 1 on the set of differences $K - N$. We have just seen that $\langle S, \varphi_y \rangle = \langle \eta S, \varphi_y \rangle$ for all y in N . Proposition 5.7c shows that $\psi \mapsto \langle \eta S, \psi_y \rangle$ is continuous from $C_{\text{com}}^\infty(\mathbb{R}^N)$ into $C_{\text{com}}^\infty(\mathbb{R}^N)$, hence from C_K^∞ into $C_{\text{com}}^\infty(\mathbb{R}^N)$, hence from C_K^∞ into $C^\infty(\mathbb{R}^N)$. Therefore $\varphi \mapsto \langle S, \varphi_y \rangle$ is continuous from C_K^∞ into $C^\infty(\mathbb{R}^N)$. \square

Corollary 5.14. Let S be in $\mathcal{D}'(\mathbb{R}^N)$, T be in $\mathcal{E}'(\mathbb{R}^N)$, and φ be in $C_{\text{com}}^\infty(\mathbb{R}^N)$. Then

$$\langle S * T, \varphi \rangle = \langle S, T^\vee * \varphi \rangle = \langle S, \langle T, \varphi_x \rangle \rangle = \langle T, \langle S, \varphi_y \rangle \rangle.$$

Moreover, $D^\alpha(S * T) = (D^\alpha S) * T = S * (D^\alpha T)$ for every multi-index α .

REMARKS. The first two equalities follow by definition of $S * T$ and by application of Corollary 5.12. The new statements in the corollary are the third equality and the derivative formula. The right side $\langle T, \langle S, \varphi_y \rangle \rangle$ of the displayed equation is well defined, since Proposition 5.13 shows that $\langle S, \varphi_y \rangle$ is in $C^\infty(\mathbb{R}^N)$.

PROOF. Let N be a bounded open set containing $\text{support}(T)$, and choose a function $\eta \in C_{\text{com}}^\infty(\mathbb{R}^N)$ that is identically 1 on the set of differences $\text{support}(\varphi) - N$. Proposition 5.7g shows that

$$\begin{aligned} \text{support}(T^\vee * \varphi) &\subseteq \text{support}(\varphi) + \text{support}(T^\vee) \\ &= \text{support}(\varphi) - \text{support}(T) \\ &\subseteq \text{support}(\varphi) - N, \end{aligned}$$

and the fact that η is identically 1 on $\text{support}(\varphi) - N$ implies that

$$(\eta)(T^\vee * \varphi) = T^\vee * \varphi. \quad (*)$$

Meanwhile, Proposition 5.13 shows that

$$\langle S, \varphi_y \rangle = \langle \eta S, \varphi_y \rangle \quad (**)$$

for all y in N , hence for all y in $\text{support}(T)$. Therefore

$$\begin{aligned} \langle T, \langle S, \varphi_y \rangle \rangle &= \langle T, \langle \eta S, \varphi_y \rangle \rangle && \text{by (**)} \\ &= \langle T, (\eta S)^\vee * \varphi \rangle && \text{by Corollary 5.10} \\ &= \langle \eta S * T, \varphi \rangle && \text{by Corollary 5.11} \\ &= \langle \eta S, T^\vee * \varphi \rangle && \text{by Corollary 5.10} \\ &= \langle S, \eta(T^\vee * \varphi) \rangle && \text{by definition} \\ &= \langle S, T^\vee * \varphi \rangle && \text{by (*).} \end{aligned} \quad (\dagger)$$

For one of the derivative formulas, we have

$$\langle D^\alpha(S * T), \varphi \rangle = (-1)^{|\alpha|} \langle S * T, D^\alpha \varphi \rangle = (-1)^{|\alpha|} \langle S, \langle T, (D^\alpha \varphi)_x \rangle \rangle.$$

Proposition 5.7b shows that this expression is equal to

$$(-1)^{|\alpha|} \langle S, D^\alpha \langle T, \varphi_x \rangle \rangle = \langle D^\alpha S, \langle T, \varphi_x \rangle \rangle,$$

and the definition of convolution shows that the latter expression is equal to $\langle (D^\alpha S) * T, \varphi \rangle$. Hence $D^\alpha(S * T) = (D^\alpha S) * T$. For the other derivative formula we have

$$\langle D^\alpha(S * T), \varphi \rangle = (-1)^{|\alpha|} \langle S * T, D^\alpha \varphi \rangle = (-1)^{|\alpha|} \langle T, \langle S, (D^\alpha \varphi)_y \rangle \rangle.$$

Proposition 5.13 shows that this expression is equal to

$$(-1)^{|\alpha|} \langle T, D^\alpha \langle S, \varphi_y \rangle \rangle = \langle D^\alpha T, \langle S, \varphi_y \rangle \rangle,$$

and step (†) shows that the latter expression is equal to

$$\langle S, (D^\alpha T)^\vee * \varphi \rangle = \langle S * (D^\alpha T), \varphi \rangle.$$

Hence $D^\alpha(S * T) = S * (D^\alpha T)$. \square

For S in $\mathcal{D}'(\mathbb{R}^N)$ and φ in $C_{\text{com}}^\infty(\mathbb{R}^N)$, we now define

$$(S^\vee * \varphi)(y) = \langle S, \varphi_y \rangle.$$

Corollary 5.8 shows that this definition is consistent with our earlier definition when S is in the subset $\mathcal{E}'(\mathbb{R}^N)$ of $\mathcal{D}'(\mathbb{R}^N)$. Proposition 5.13 shows that the linear map $\varphi \mapsto S * \varphi$ is continuous from $C_{\text{com}}^\infty(\mathbb{R}^N)$ into $C^\infty(\mathbb{R}^N)$.

Corollary 5.15. Let S be in $\mathcal{D}'(\mathbb{R}^N)$, T be in $\mathcal{E}'(\mathbb{R}^N)$, and φ be in $C_{\text{com}}^\infty(\mathbb{R}^N)$. Then

$$\langle S * T, \varphi \rangle = \langle S, T^\vee * \varphi \rangle = \langle S, \langle T, \varphi_x \rangle \rangle = \langle T, \langle S, \varphi_y \rangle \rangle = \langle T, S^\vee * \varphi \rangle,$$

and $(S * T)^\vee = S^\vee * T^\vee$.

PROOF. The displayed line just adds the above definition to the conclusion of Corollary 5.14. For the other formula we use Corollary 5.12 to write $\langle (S * T)^\vee, \varphi \rangle = \langle S * T, \varphi^\vee \rangle = \langle S, T^\vee * \varphi^\vee \rangle = \langle S, (T * \varphi)^\vee \rangle = \langle S^\vee, T * \varphi \rangle = \langle S^\vee * T^\vee, \varphi \rangle$. \square

With the symmetry that has been established in Corollary 5.15, we allow ourselves to write $T * S$ for $S * T$ when S is in $\mathcal{D}'(\mathbb{R}^N)$ and T is in $\mathcal{E}'(\mathbb{R}^N)$. This notation is consistent with the equality $S * T = T * S$ established in Proposition 5.7f when S and T both have compact support.

Corollary 5.16. Suppose that S is in $\mathcal{D}'(\mathbb{R}^N)$, that f is in $C^\infty(\mathbb{R}^N)$, and that at least one of S and f has compact support. If φ is in $C_{\text{com}}^\infty(\mathbb{R}^N)$, then

$$\langle S * T_f, \varphi \rangle = \langle S, f^\vee * \varphi \rangle.$$

Moreover, $S * T_f$ is given by the C^∞ function $y \mapsto \langle S, (f^\vee)_{-y} \rangle$, i.e.,

$$S * T_f = T_F \quad \text{with } F(y) = \langle S, (f^\vee)_{-y} \rangle.$$

REMARK. If *both* S and f have compact support, Corollary 5.16 reduces to Corollary 5.8.

PROOF. First suppose that S has compact support. Theorem 5.1 allows us to write S as $\langle S, \psi \rangle = \sum_\alpha \int_{\mathbb{R}^N} D^\alpha \psi \, d\rho_\alpha$, with the sum involving only finitely many terms and with the complex Borel measures ρ_α compactly supported. Applying Corollary 5.15 to $S * T_f$ and using the definition of $S^\vee * \varphi$, we obtain

$$\begin{aligned} \langle S * T_f, \varphi \rangle &= \int_{\mathbb{R}^N} f(y) (S^\vee * \varphi)(y) \, dy \\ &= \int_{\mathbb{R}^N} f(y) \sum_\alpha \int_{\mathbb{R}^N} D^\alpha \varphi_y(x) \, d\rho_\alpha(x) \, dy \\ &= \int_{\mathbb{R}^N} \sum_\alpha \int_{\mathbb{R}^N} f(y) D^\alpha \varphi(x+y) \, d\rho_\alpha(x) \, dy. \end{aligned}$$

Since φ and the ρ_α 's are compactly supported, we may freely interchange the order of integration to see that the above expression is equal to

$$\begin{aligned} &\sum_\alpha \int_{\mathbb{R}^N} \left[\int_{\mathbb{R}^N} f(y) D^\alpha \varphi(x+y) \, dy \right] d\rho_\alpha(x) \\ &= \sum_\alpha \int_{\mathbb{R}^N} (f^\vee * D^\alpha \varphi)(x) \, d\rho_\alpha(x) \\ &= \sum_\alpha \int_{\mathbb{R}^N} (D^\alpha (f^\vee) * \varphi)(x) \, d\rho_\alpha(x) \\ &= \sum_\alpha \int_{\mathbb{R}^N} \left[\int_{\mathbb{R}^N} D^\alpha (f^\vee)(x-y) \varphi(y) \, dy \right] d\rho_\alpha(x) \\ &= \int_{\mathbb{R}^N} \left[\sum_\alpha \int_{\mathbb{R}^N} D^\alpha (f^\vee)(x-y) \, d\rho_\alpha(x) \right] \varphi(y) \, dy \\ &= \int_{\mathbb{R}^N} \langle S, (f^\vee)_{-y} \rangle \varphi(y) \, dy \\ &= \langle T_F, \varphi \rangle, \end{aligned}$$

as asserted.

Next suppose instead that f has compact support. Then

$$\langle S * T_f, \varphi \rangle = \langle S, (T_f)^\vee * \varphi \rangle = \langle S, T_{f^\vee} * \varphi \rangle = \langle S, f^\vee * \varphi \rangle. \quad (*)$$

We are to show that this expression is equal to

$$\langle T_F, \varphi \rangle = \langle T_{\langle S, (f^\vee)_{-y} \rangle}, \varphi \rangle = \int_{\mathbb{R}^N} \langle S, (f^\vee)_{-y} \rangle \varphi(y) \, dy. \quad (**)$$

We introduce a member η of $C_{\text{com}}^\infty(\mathbb{R}^N)$ that is identically 1 on the set of sums $\text{support}(f^\vee) + \text{support}(\varphi)$. Since ηS is in $\mathcal{E}'(\mathbb{R}^N)$, Corollary 5.8 shows that

$$\langle \eta S, f^\vee * \varphi \rangle = \int_{\mathbb{R}^N} \langle \eta S, (f^\vee)_{-y} \rangle \varphi(y) dy = \int_{\mathbb{R}^N} \langle S, \eta (f^\vee)_{-y} \rangle \varphi(y) dy.$$

In view of (*) and (**), it is therefore enough to prove the two identities

$$\langle \eta S, f^\vee * \varphi \rangle = \langle S, f^\vee * \varphi \rangle \quad (\dagger)$$

and

$$\int_{\mathbb{R}^N} \langle S, \eta (f^\vee)_{-y} \rangle \varphi(y) dy = \int_{\mathbb{R}^N} \langle S, (f^\vee)_{-y} \rangle \varphi(y) dy. \quad (\dagger\dagger)$$

Since $\text{support}(f^\vee * \varphi) \subseteq \text{support}(f^\vee) + \text{support}(\varphi)$, we have $\eta(f^\vee * \varphi) = f^\vee * \varphi$ and therefore $\langle \eta S, f^\vee * \varphi \rangle = \langle S, \eta(f^\vee * \varphi) \rangle = \langle S, f^\vee * \varphi \rangle$. This proves (\dagger).

To prove ($\dagger\dagger$), it is enough to show that $\eta(f^\vee)_{-y} = (f^\vee)_{-y}$ for every y in $\text{support}(\varphi)$. For a given y in $\text{support}(\varphi)$, there is nothing to prove at points x where $(f^\vee)_{-y}(x) = 0$. If $(f^\vee)_{-y}(x) \neq 0$, then $f^\vee(x - y) \neq 0$ and $x - y$ is in $\text{support}(f^\vee)$. Hence $x = y + (x - y)$ is in $\text{support}(\varphi) + \text{support}(f^\vee)$, and $\eta(x)(f^\vee)_{-y}(x) = (f^\vee)_{-y}(x)$. This proves ($\dagger\dagger$). \square

Corollary 5.17. Convolution of two distributions, one of which has compact support, is consistent with convolution of smooth functions, one of which has compact support, in the sense that if f and g are smooth and one of them has compact support, then $T_g * T_f$ is given by the C^∞ function $T_g * f$ and by the C^∞ function $T_f * g$, and these functions equal $g * f$.

PROOF. We apply Corollary 5.16 with $S = T_g$, and we find that $T_g * T_f$ is given by the smooth function that carries y to $\langle T_g, (f^\vee)_{-y} \rangle$. In turn, this latter expression equals $\int_{\mathbb{R}^N} g(x)(f^\vee)_{-y}(x) dx = \int_{\mathbb{R}^N} g(x)f^\vee(x - y) dx = \int_{\mathbb{R}^N} g(x)f(y - x) dx = (g * f)(y)$. Hence $T_g * f = g * f$. Reversing the roles of f and g , we obtain $T_f * g = f * g = g * f$. \square

Corollary 5.18. If R , S , and T are distributions and ψ and φ are smooth functions, then

- (a) $(T * \psi) * \varphi = T * (\psi * \varphi)$ provided at least two of T , ψ , and φ have compact support,
- (b) $(S * T) * \varphi = (S * \varphi) * T$ provided at least two of S , T , and φ have compact support,
- (c) $R * (S * T) = (R * S) * T$ provided at least two of R , S , and T have compact support.

PROOF. Let η be in $C_{\text{com}}^\infty(\mathbb{R}^N)$. We make repeated use of Corollaries 5.15 through 5.17 in each part. For (a), we use associativity of convolution of smooth functions (Proposition 5.5b) to write

$$\begin{aligned}\langle T * T_{\psi * \varphi}, \eta \rangle &= \langle T, (\psi * \varphi)^\vee * \eta \rangle = \langle T, (\psi^\vee * \varphi^\vee) * \eta \rangle \\ &= \langle T, \psi^\vee * (\varphi^\vee * \eta) \rangle = \langle T * T_\psi, \varphi^\vee * \eta \rangle \\ &= \langle (T * T_\psi) * T_\varphi, \eta \rangle.\end{aligned}$$

Thus $T * T_{\psi * \varphi} = (T * T_\psi) * T_\varphi$. Since $T * T_{\psi * \varphi} = T_{T * (\psi * \varphi)}$ and $(T * T_\psi) * T_\varphi = T_{T * \psi} * T_\varphi = T_{(T * \psi) * \varphi}$, we obtain $T * (\psi * \varphi) = (T * \psi) * \varphi$. This proves (a).

For (b), we use (a) to write

$$\begin{aligned}\langle (S * T) * T_\varphi, \eta \rangle &= \langle S * T, \varphi^\vee * \eta \rangle = \langle S, T^\vee * (\varphi^\vee * \eta) \rangle \\ &= \langle S, (T^\vee * \varphi^\vee) * \eta \rangle = \langle S, (T * \varphi)^\vee * \eta \rangle \\ &= \langle S, (T * T_\varphi)^\vee * \eta \rangle = \langle S * (T * T_\varphi), \eta \rangle.\end{aligned}$$

Thus $(S * T) * T_\varphi = S * (T * T_\varphi)$. Since $(S * T) * T_\varphi = T_{(S * T) * \varphi}$ and $S * (T * T_\varphi) = S * T_{T * \varphi} = T_{S * (T * \varphi)}$, we obtain $(S * T) * \varphi = S * (T * \varphi)$.

For (c), we use (b) to write

$$\begin{aligned}\langle R * (S * T), \eta \rangle &= \langle R, (S * T)^\vee * \eta \rangle = \langle R, (S^\vee * T^\vee) * \eta \rangle \\ &= \langle R, S^\vee * (T^\vee * \eta) \rangle = \langle R * S, T^\vee * \eta \rangle \\ &= \langle (R * S) * T, \eta \rangle.\end{aligned}$$

Thus $R * (S * T) = (R * S) * T$, and (c) is proved. \square

We conclude with a special property of one particular distribution. The **Dirac distribution** at the origin is the member of $\mathcal{E}'(\mathbb{R}^N)$ given by $\langle \delta, \varphi \rangle = \varphi(0)$. It has support $\{0\}$. The proposition below shows that the differentiation operation D^α on distributions equals convolution with the distribution $D^\alpha \delta$.

Proposition 5.19. If T is in $\mathcal{D}'(\mathbb{R}^N)$ and if δ denotes the Dirac distribution at the origin, then $\delta * T = T$. Consequently $D^\alpha \delta * T = D^\alpha T$ for every multi-index α .

PROOF. For φ in $C_{\text{com}}^\infty(\mathbb{R}^N)$, Corollary 5.14 gives $\langle \delta * T, \varphi \rangle = \langle \delta, \langle T, \varphi_x \rangle \rangle = \langle T, \varphi \rangle$, and therefore $\delta * T = T$. Applying D^α and using the second conclusion of Corollary 5.14, we obtain $D^\alpha(\delta * T) = \delta * (D^\alpha T) = D^\alpha T$. \square

4. Role of Fourier Transform

The final tool we need in order to make the theory of distributions useful for linear partial differential equations is the Fourier transform. Let us write \mathcal{F} for the Fourier transform on the various places it acts, its initial definition being $\mathcal{F}(f)(\xi) = \int_{\mathbb{R}^N} f(x)e^{-2\pi i x \cdot \xi} dx$ on $L^1(\mathbb{R}^N)$. Since the Schwartz space $\mathcal{S}(\mathbb{R}^N)$ is contained in $L^1(\mathbb{R}^N)$, this definition of \mathcal{F} is applicable on $\mathcal{S}(\mathbb{R}^N)$, and it was shown in *Basic* that \mathcal{F} is one-one from $\mathcal{S}(\mathbb{R}^N)$ onto itself. We continue to use the same angular-brackets notation for $\mathcal{S}'(\mathbb{R}^N)$ as for $\mathcal{D}'(\mathbb{R}^N)$ and $\mathcal{E}'(\mathbb{R}^N)$. Then, as a consequence of Corollary 3.3b, the Fourier transform is well defined on elements T of $\mathcal{S}'(\mathbb{R}^N)$ under the definition $\langle \mathcal{F}(T), \varphi \rangle = \langle T, \mathcal{F}(\varphi) \rangle$ for $\varphi \in \mathcal{S}(\mathbb{R}^N)$, and Proposition 3.4 shows that \mathcal{F} is one-one from $\mathcal{S}'(\mathbb{R}^N)$ onto itself. On tempered distributions that are L^1 or L^2 functions, \mathcal{F} agrees with the usual definitions on functions. For f in L^1 , the verification comes down to the multiplication formula:

$$\langle \mathcal{F}T_f, \varphi \rangle = \langle T_f, \mathcal{F}\varphi \rangle = \int f(x)(\mathcal{F}\varphi)(x) dx = \int (\mathcal{F}f)(x)\varphi(x) dx = \langle T_{\mathcal{F}f}, \varphi \rangle.$$

For f in L^2 , we choose a sequence $\{f_n\}$ in $L^1 \cap L^2$ tending to f in L^2 , obtain $\langle \mathcal{F}T_{f_n}, \varphi \rangle = \langle T_{\mathcal{F}f_n}, \varphi \rangle$ for each n , and then check by continuity that we can pass to the limit.

The formulas that are used to establish the effect of \mathcal{F} on $\mathcal{S}(\mathbb{R}^N)$ come from the behavior of differentiation and multiplication by polynomials on Fourier transforms and are

$$D^\alpha(\mathcal{F}f)(x) = \mathcal{F}((-2\pi i)^{|\alpha|} x^\alpha f)(x)$$

and
$$x^\beta(\mathcal{F}f)(x) = \mathcal{F}((2\pi i)^{-|\beta|} D^\beta f)(x).$$

Let us define the effect of D^α and multiplication by x^β on tempered distributions and then see how the Fourier transform interacts with these operations. If φ is in $\mathcal{S}(\mathbb{R}^N)$, then $D^\alpha \varphi$ is in $\mathcal{S}(\mathbb{R}^N)$, and hence it makes sense to define $D^\alpha T$ for $T \in \mathcal{S}'(\mathbb{R}^N)$ by $\langle D^\alpha T, \varphi \rangle = (-1)^\alpha \langle T, D^\alpha \varphi \rangle$. The product of an arbitrary smooth function on \mathbb{R}^N by a Schwartz function need not be a Schwartz function, and thus the product of an arbitrary smooth function and a tempered distribution need not make sense as a tempered distribution. However, the product of a polynomial and a Schwartz function is a Schwartz function, and thus we can define $x^\beta T$ for $T \in \mathcal{S}'(\mathbb{R}^N)$ by $\langle x^\beta T, \varphi \rangle = \langle T, x^\beta \varphi \rangle$. The formulas for the Fourier transform are then

$$\mathcal{F}(D^\alpha T) = (2\pi i)^{|\alpha|} x^\alpha \mathcal{F}(T)$$

and
$$\mathcal{F}(x^\beta T) = (-2\pi i)^{-|\beta|} D^\beta \mathcal{F}(T).$$

In fact, we compute that $\langle \mathcal{F}(D^\alpha T), \varphi \rangle = \langle D^\alpha T, \mathcal{F}\varphi \rangle = (-1)^{|\alpha|} \langle T, D^\alpha \mathcal{F}\varphi \rangle = (-1)^{|\alpha|} \langle T, \mathcal{F}((-2\pi i)^{|\alpha|} x^\alpha \varphi) \rangle = (2\pi i)^{|\alpha|} \langle \mathcal{F}(T), x^\alpha \varphi \rangle = (2\pi i)^{|\alpha|} \langle x^\alpha \mathcal{F}(T), \varphi \rangle$ and that $\langle \mathcal{F}(x^\beta T), \varphi \rangle = \langle x^\beta T, \mathcal{F}\varphi \rangle = \langle T, x^\beta \mathcal{F}\varphi \rangle = \langle T, \mathcal{F}((2\pi i)^{-|\beta|} D^\beta \varphi) \rangle = (2\pi i)^{-|\beta|} \langle \mathcal{F}(T), D^\beta \varphi \rangle = (-2\pi i)^{-|\beta|} \langle D^\beta \mathcal{F}(T), \varphi \rangle$.

We have seen that the restriction map carries $\mathcal{E}'(\mathbb{R}^N)$ in one-one fashion into $\mathcal{S}'(\mathbb{R}^N)$. Therefore we can identify members of $\mathcal{E}'(\mathbb{R}^N)$ with certain members of $\mathcal{S}'(\mathbb{R}^N)$ when it is convenient to do so, and in particular the Fourier transform becomes a well-defined one-one map of $\mathcal{E}'(\mathbb{R}^N)$ into $\mathcal{S}'(\mathbb{R}^N)$. (The Fourier transform is not usable, however, with $\mathcal{D}'(\mathbb{R}^N)$.) The somewhat surprising fact is that the Fourier transform of a member of $\mathcal{E}'(\mathbb{R}^N)$ is actually a smooth function, not just a distribution. We shall prove this fact as a consequence of Theorem 5.1, which has expressed distributions of compact support in terms of complex measures of compact support.

Theorem 5.20. If T is a member of $\mathcal{E}'(\mathbb{R}^N)$ with support in a compact subset K of \mathbb{R}^N , then the tempered distribution $\mathcal{F}(T)$ equals a smooth function that extends to an entire holomorphic function on \mathbb{C}^N . The value of this function at $z \in \mathbb{C}^N$ is given by

$$\mathcal{F}(T)(z) = \langle T, e^{-2\pi iz \cdot (\cdot)} \rangle,$$

and there is a positive integer m such that this function satisfies

$$|D^\beta(\mathcal{F}T)(\xi)| \leq C_\beta(1 + |\xi|)^m$$

for $\xi \in \mathbb{R}^N$ and for every multi-index β .

REMARK. The estimate shows that the product of $\langle T, e^{-2\pi iz \cdot (\cdot)} \rangle$ by a Schwartz function is again a Schwartz function, hence that the tempered distribution $\mathcal{F}(T)$ is indeed given by a certain smooth function.

PROOF. Fix a compact set K' whose interior contains K . Theorem 5.1 allows us to write

$$\langle T, \varphi_0 \rangle = \sum_{|\alpha| \leq m} \int_{K'} D^\alpha \varphi_0 d\rho_\alpha$$

for all $\varphi_0 \in C^\infty(\mathbb{R}^N)$. Replacing φ_0 by $e^{-2\pi iz \cdot (\cdot)}$ gives

$$\langle T, e^{-2\pi iz \cdot (\cdot)} \rangle = \sum_{|\alpha| \leq m} \int_{K'} D_\xi^\alpha e^{-2\pi iz \cdot \xi} d\rho_\alpha(\xi),$$

which shows that $z \mapsto \langle T, e^{-2\pi iz \cdot (\cdot)} \rangle$ is holomorphic in \mathbb{C}^N and gives the estimate

$$|D_x^\beta \langle T, e^{-2\pi ix \cdot (\cdot)} \rangle| \leq \sum_{|\alpha| \leq m} \int_{\xi \in K'} |D_x^\beta D_\xi^\alpha e^{-2\pi ix \cdot \xi}| d|\rho_\alpha|(\xi) \leq C_\beta(1 + |x|)^m.$$

Replacing φ_0 by $\mathcal{F}\varphi$ with φ in $C_{\text{com}}^\infty(\mathbb{R}^N)$ gives

$$\begin{aligned} \langle \mathcal{F}(T), \varphi \rangle &= \langle T, \mathcal{F}\varphi \rangle = \sum_{|\alpha| \leq m} \int_{\xi \in K'} D_\xi^\alpha \mathcal{F}\varphi(\xi) d\rho_\alpha(\xi) \\ &= \sum_{|\alpha| \leq m} \int_{\xi \in K'} D_\xi^\alpha \int_{x \in \mathbb{R}^N} e^{-2\pi ix \cdot \xi} \varphi(x) dx d\rho_\alpha(\xi) \end{aligned}$$

$$\begin{aligned}
&= \sum_{|\alpha| \leq m} \int_{\xi \in K'} \int_{x \in \mathbb{R}^N} D_\xi^\alpha e^{-2\pi i x \cdot \xi} \varphi(x) dx d\rho_\alpha(\xi) \\
&= \int_{x \in \mathbb{R}^N} \left(\sum_{|\alpha| \leq m} \int_{\xi \in K'} D_\xi^\alpha e^{-2\pi i x \cdot \xi} d\rho_\alpha(\xi) \right) \varphi(x) dx \\
&= \int_{x \in \mathbb{R}^N} \langle T, e^{-2\pi i x \cdot (\cdot)} \rangle \varphi(x) dx.
\end{aligned}$$

Both sides are continuous functions of the Schwartz-space variable φ on the dense subset $C_{\text{com}}^\infty(\mathbb{R}^N)$, and hence the formula extends to be valid for φ in $\mathcal{S}(\mathbb{R}^N)$. This proves that $\mathcal{F}(T)$ is given on $\mathcal{S}(\mathbb{R}^N)$ by the function $x \mapsto \langle T, e^{-2\pi i x \cdot (\cdot)} \rangle$. The estimate on D_x^β of this function has been obtained above, and the theorem follows. \square

EXAMPLE. There is an important instance of the formula of the proposition that can be established directly without appealing to the proposition. The Dirac distribution δ at the origin, defined by $\langle \delta, \varphi \rangle = \varphi(0)$, has Fourier transform $\mathcal{F}(\delta)$ equal to the constant function 1 because $\langle \mathcal{F}(\delta), \varphi \rangle = \langle \delta, \mathcal{F}(\varphi) \rangle = \mathcal{F}(\varphi)(0) = \int_{\mathbb{R}^N} \varphi dx = \langle T_1, \varphi \rangle$, where T_1 denotes the distribution equal to the smooth function 1. Therefore $\mathcal{F}(D^\alpha \delta) = (2\pi i)^{|\alpha|} x^\alpha T_1$, i.e., $\mathcal{F}(D^\alpha \delta)$ equals the function $x \mapsto (2\pi i)^{|\alpha|} x^\alpha$. The formula of the proposition when $T = D^\alpha \delta$ says that this function equals $(D^\alpha \delta)(e^{-2\pi i x \cdot (\cdot)})$, and we can see this equality directly because $\langle D^\alpha \delta, e^{-2\pi i x \cdot (\cdot)} \rangle = (-1)^{|\alpha|} \langle \delta, D^\alpha e^{-2\pi i x \cdot (\cdot)} \rangle = (-1)^{|\alpha|} (-2\pi i)^{|\alpha|} x^\alpha \langle \delta, e^{-2\pi i x \cdot (\cdot)} \rangle = (2\pi i)^{|\alpha|} x^\alpha$.

We know that the convolution of two distributions is meaningful if one of them has compact support. Since the (pointwise) product of two general tempered distributions is undefined, we might not at first expect that the Fourier transform could be helpful with understanding this kind of convolution. However, Theorem 5.20 says that there is reason for optimism: the product of the Fourier transform of a distribution of compact support by a tempered distribution is indeed defined. This is the clue that suggests the second theorem of this section.

Theorem 5.21. If S is in $\mathcal{E}'(\mathbb{R}^N)$ and T is in $\mathcal{S}'(\mathbb{R}^N)$, then $S * T$ is in $\mathcal{S}'(\mathbb{R}^N)$, and $\mathcal{F}(S * T) = \mathcal{F}(S)\mathcal{F}(T)$.

PROOF. We know that $S * T$ is in $\mathcal{D}'(\mathbb{R}^N)$, and we shall check that $S * T$ is actually in $\mathcal{S}'(\mathbb{R}^N)$, so that $\mathcal{F}(S * T)$ is defined: We start with φ in $C_{\text{com}}^\infty(\mathbb{R}^N)$ and the identity $\langle S * T, \varphi \rangle = \langle S, T^\vee * \varphi \rangle = \langle S^\vee, T * \varphi^\vee \rangle$. Since S has compact support, there is a compact set K and there are constants C and m such that

$$\begin{aligned}
|\langle S * T, \varphi \rangle| &\leq C \sum_{|\alpha| \leq m} \sup_{x \in K} |D^\alpha (T * \varphi^\vee)(x)| = C \sum_{|\alpha| \leq m} \sup_{x \in K} |T * D^\alpha (\varphi^\vee)(x)| \\
&= C \sum_{|\alpha| \leq m} \sup_{x \in K} |\langle T, ((D^\alpha (\varphi^\vee))^\vee)_x \rangle| = C \sum_{|\alpha| \leq m} \sup_{x \in K} |\langle T, (D^\alpha \varphi)_x \rangle|.
\end{aligned}$$

Since T is tempered, there exist constants C' , m' , and k such that the right side is

$$\leq CC' \sum_{\substack{|\alpha| \leq m, \\ |\beta| \leq m'}} \sup_{x \in K, y \in \mathbb{R}^N} |(1 + |y|^2)^k D^\beta (D^\alpha \varphi)_x(y)|;$$

in turn, this expression is estimated by Schwartz-space norms for φ , and thus $S * T$ is in $\mathcal{S}'(\mathbb{R}^N)$.

Now let φ and ψ be Schwartz functions with φ and $\mathcal{F}(\psi)$ in $C_{\text{com}}^\infty(\mathbb{R}^N)$. Then

$$\begin{aligned} \langle \mathcal{F}(T_\varphi * T), \psi \rangle &= \langle T_\varphi * T, \mathcal{F}(\psi) \rangle = \langle T, \varphi^\vee * \mathcal{F}(\psi) \rangle \\ &= \langle \mathcal{F}(T), \mathcal{F}^{-1}(\varphi^\vee * \mathcal{F}(\psi)) \rangle = \langle \mathcal{F}(T), (\mathcal{F}^{-1}(\varphi^\vee)) \mathcal{F}^{-1}(\mathcal{F}(\psi)) \rangle \\ &= \langle \mathcal{F}(T), \mathcal{F}^{-1}(\varphi^\vee) \psi \rangle = \langle \mathcal{F}(T), (\mathcal{F}(\varphi)) \psi \rangle = \langle \mathcal{F}(\varphi) \mathcal{F}(T), \psi \rangle, \end{aligned}$$

the next-to-last equality following since $\mathcal{F}^{-1}(\varphi^\vee) = \mathcal{F}(\varphi)$ by the Fourier inversion formula. Since the ψ 's with $\mathcal{F}(\psi)$ in $C_{\text{com}}^\infty(\mathbb{R}^N)$ are dense in $\mathcal{S}(\mathbb{R}^N)$,

$$\mathcal{F}(T_\varphi * T) = \mathcal{F}(\varphi) \mathcal{F}(T). \quad (*)$$

Finally let φ and ψ be in $C_{\text{com}}^\infty(\mathbb{R}^N)$. Corollary 5.18 gives $T_\varphi * (S * T) = (T_\varphi * S) * T$. Taking the Fourier transform of both sides and applying (*) three times, we obtain

$$\begin{aligned} \mathcal{F}(\varphi) \mathcal{F}(S * T) &= \mathcal{F}(T_\varphi * (S * T)) = \mathcal{F}((T_\varphi * S) * T) \\ &= \mathcal{F}(T_\varphi * S) \mathcal{F}(T) = \mathcal{F}(\varphi) \mathcal{F}(S) \mathcal{F}(T). \end{aligned}$$

Hence we have $\langle \mathcal{F}(\varphi) \mathcal{F}(S * T), \psi \rangle = \langle \mathcal{F}(\varphi) \mathcal{F}(S) \mathcal{F}(T), \psi \rangle$ and therefore

$$\langle \mathcal{F}(S * T), \mathcal{F}(\varphi) \psi \rangle = \langle \mathcal{F}(S) \mathcal{F}(T), \mathcal{F}(\varphi) \psi \rangle \quad \text{for all } \varphi \in C_{\text{com}}^\infty(\mathbb{R}^N).$$

The set of functions $\mathcal{F}(\varphi)$ is dense in $\mathcal{S}(\mathbb{R}^N)$. Moreover, if $\eta_k \rightarrow \eta$ in $\mathcal{S}(\mathbb{R}^N)$, then $\eta_k \psi \rightarrow \eta \psi$ in $\mathcal{S}(\mathbb{R}^N)$. Choosing a sequence of φ 's for which $\mathcal{F}(\varphi)$ tends in $\mathcal{S}(\mathbb{R}^N)$ to a function in $C_{\text{com}}^\infty(\mathbb{R}^N)$ that is 1 on the support of ψ , we obtain

$$\langle \mathcal{F}(S * T), \psi \rangle = \langle \mathcal{F}(S) \mathcal{F}(T), \psi \rangle.$$

Since the set of ψ 's is dense in $\mathcal{S}(\mathbb{R}^N)$, we conclude that $\mathcal{F}(S * T) = \mathcal{F}(S) \mathcal{F}(T)$. \square

5. Fundamental Solution of Laplacian

The availability of distributions makes it possible to write familiar partial differential equations in a general but convenient notation. For example consider the equation $\Delta u = f$ in \mathbb{R}^N , where Δ is the Laplacian. We regard f as known and u as unknown. Ordinarily we might think of f as some function, possibly with some smoothness properties, and we are seeking a solution u that is another function. However, we can regard any locally integrable function f as a distribution T_f and seek a distribution T with $\Delta T = T_f$. In this sense the equation $\Delta u = f$ in the sense of distributions includes the equation in the ordinary sense of functions.

In this section we shall solve this equation when the distribution on the right side has compact support. To handle existence, the technique is to exhibit a **fundamental solution** for the Laplacian, i.e., a solution of the equation $\Delta T = \delta$, where δ is the Dirac distribution at 0, and then to use the rules of Sections 2–3 for manipulating distributions.⁷ The argument for this special case will avoid using the full power of Theorem 5.21, but a generalization to other “elliptic” operators with constant coefficients that we consider in Chapter VII will call upon the full theorem.

In this section we shall make use of Green’s formula for a ball, as in Proposition 3.14. As we observed in a footnote when applying the proposition in the proof of Theorem 3.16, the result as given in that proposition directly extends from balls to the difference of two balls. The extended result is as follows: If B_R and B_ϵ are closed concentric balls of radii $\epsilon < R$ and if u and v are C^2 functions on a neighborhood of $E = B_R \cap (B_\epsilon)^c$, then

$$\int_E (u \Delta v - v \Delta u) dx = \int_{\partial E} \left(u \frac{\partial v}{\partial \mathbf{n}} - v \frac{\partial u}{\partial \mathbf{n}} \right) d\sigma,$$

where $d\sigma$ is “surface-area” measure on ∂E and the indicated derivatives are directional derivatives pointing outward from E in the direction of a unit normal vector.

Theorem 5.22. In \mathbb{R}^N with $N > 2$, let T be the tempered distribution $-\Omega_{N-1}^{-1} (N-2)^{-1} |x|^{-(N-2)} dx$, where Ω_{N-1} is the area of the unit sphere S^{N-1} . Then $\Delta T = \delta$, where δ is the Dirac distribution at 0.

REMARK. The statement uses the name $f(x) dx$ for a certain distribution, rather than T_f , for the sake of readability.

⁷Although a fundamental solution for the Laplacian is being shown to exist, it is not unique. One can add to it the distribution T_f for any smooth function f that is harmonic in all of \mathbb{R}^N .

PROOF. We are to prove that each φ in $C_{\text{com}}^\infty(\mathbb{R}^N)$ satisfies $\langle \Delta T, \varphi \rangle = \langle \delta, \varphi \rangle$, i.e., that the second equality holds in the chain of equalities

$$\varphi(0) = \langle \delta, \varphi \rangle = \langle \Delta T, \varphi \rangle = \langle T, \Delta \varphi \rangle = -\frac{1}{\Omega_{N-1}(N-2)} \int_{\mathbb{R}^N} \frac{\Delta \varphi(x) dx}{|x|^{N-2}}.$$

We apply Green's formula as above with the closed balls B_R and B_ϵ centered at the origin, with R chosen large enough so that $\text{support}(\varphi) \subseteq B_R^\circ$, with $u = |x|^{-(N-2)}$, and with $v = \varphi$. Writing r for $|x|$ and observing that $\Delta u = 0$ on $B_R - B_\epsilon$ and that $\frac{\partial \varphi}{\partial \mathbf{n}} = -\nabla \varphi \cdot \frac{x}{r}$ on the boundary of B_ϵ , we obtain

$$\int_{\partial B_\epsilon} \left(-r^{-(N-2)} \frac{x \cdot \nabla \varphi}{r} - \left((\varphi) \left(-\frac{d}{dr} (r^{-(N-2)}) \right) \right) \right) \epsilon^{N-1} d\omega = \int_{B_R - B_\epsilon} r^{-(N-2)} \Delta \varphi dx.$$

On the left side the first term has $|x \cdot \nabla \varphi|/r$ bounded; hence its absolute value is at most a constant times $\int_{\partial B_\epsilon} \epsilon d\omega$, which tends to 0 as ϵ decreases to 0. The second term on the left side is $-(N-2)\epsilon^{-(N-1)} \int_{\partial B_\epsilon} \varphi \epsilon^{N-1} d\omega$, and it tends, as ϵ decreases to 0, to $-(N-2)\Omega_{N-1}\varphi(0)$. The result in the limit as ϵ decreases to 0 is that

$$-(N-2)\Omega_{N-1}\varphi(0) = \int_{\mathbb{R}^N} r^{-(N-2)} \Delta \varphi dx,$$

and the theorem follows. \square

Corollary 5.23. In \mathbb{R}^N with $N > 2$, let T be the tempered distribution $-\Omega_{N-1}^{-1}(N-2)^{-1}|x|^{-(N-2)} dx$, where Ω_{N-1} is the area of the unit sphere S^{N-1} . If f is in $\mathcal{E}'(\mathbb{R}^N)$, then $u = T * f$ is a tempered distribution and is a solution of $\Delta u = f$.

PROOF. Let δ be the Dirac distribution at 0, so that $\Delta T = \delta$ by Theorem 5.22. Theorem 5.21 shows that $T * f$ is a tempered distribution, and Corollaries 5.14 and 5.19 give $\Delta(T * f) = (\Delta T) * f = \delta * f = f$, as required. \square

BIBLIOGRAPHICAL REMARKS. The development in Sections 2–4 is adapted from Hörmander's Volume I of *The Analysis of Linear Partial Differential Equations*.

6. Problems

1. Prove that if U and V are open subsets of \mathbb{R}^N with $U \subseteq V$, then the inclusion $C_{\text{com}}^\infty(U) \rightarrow C_{\text{com}}^\infty(V)$ is continuous.
2. Prove that if φ is in $C_{\text{com}}^\infty(U)$, then the map $\psi \mapsto \psi\varphi$ of $C^\infty(U)$ into $C_{\text{com}}^\infty(U)$ is continuous.

3. Let U be a nonempty open set in \mathbb{R}^N . Any member T_U of $\mathcal{E}'(U)$ extends to a member T of $\mathcal{E}'(\mathbb{R}^N)$ under the definition $\langle T, \varphi \rangle = \langle T_U, \varphi|_U \rangle$ for $\varphi \in C^\infty(\mathbb{R}^N)$. Prove that this is truly an extension in the sense that if φ_1 is in $C^\infty(U)$ and if φ is in $C^\infty(\mathbb{R}^N)$ and agrees with φ_1 in a neighborhood of the support of T_U , then $\langle T, \varphi \rangle = \langle T_U, \varphi|_U \rangle = \langle T_U, \varphi_1 \rangle$.
4. Prove the following variant of Theorem 5.1: Let K and K' be closed balls of \mathbb{R}^N with K contained in the interior of K' . If T is a member of $\mathcal{E}'(\mathbb{R}^N)$ with support in K , then there exist a positive integer m and members g_α of $L^2(K', dx)$ for each multi-index α with $|\alpha| \leq m$ such that

$$\langle T, \varphi \rangle = \sum_{|\alpha| \leq m} \int_{K'} (D^\alpha \varphi) g_\alpha dx \quad \text{for all } \varphi \in C^\infty(\mathbb{R}^N).$$

5. Let K be a compact metric space, and let μ be a Borel measure on K . Suppose that $\Phi = \Phi(x, y)$ is a scalar-valued function on $\mathbb{R}^N \times K$ such that $\Phi(\cdot, y)$ is smooth for each y in K , and suppose further that every iterated partial derivative $D_1^\alpha \Phi$ in the first variable is continuous on $\mathbb{R}^N \times K$. Define

$$F(x) = \int_K \Phi(x, y) d\mu(y).$$

- (a) Prove that any T in $\mathcal{E}'(\mathbb{R}^N)$ satisfies $\langle T, F \rangle = \int_K \langle T, \Phi(\cdot, y) \rangle d\mu(y)$.
- (b) Suppose that Φ has compact support in $\mathbb{R}^N \times K$. Prove that any S in $\mathcal{D}'(\mathbb{R}^N)$ satisfies $\langle S, F \rangle = \int_K \langle S, \Phi(\cdot, y) \rangle d\mu(y)$.
6. Suppose that T is a distribution on an open set U in \mathbb{R}^N such that $\langle T, \varphi \rangle \geq 0$ whenever φ is a member of $C_{\text{com}}^\infty(U)$ that is ≥ 0 . Prove that there is a Borel measure $\mu \geq 0$ on U such that $\langle T, \varphi \rangle = \int_U \varphi d\mu$ for all φ in $C_{\text{com}}^\infty(U)$.
7. Verify the formula of Theorem 5.22 for $\varphi(x) = e^{-\pi|x|^2}$, namely that

$$\int_{\mathbb{R}^N} |x|^{-(N-2)} (\Delta \varphi)(x) dx = -\Omega_{N-1} (N-2) \varphi(0)$$

for this φ , by evaluating the integral in spherical coordinates.

Problems 8–11 deal with special situations in which the conclusion of Theorem 5.1 can be improved to say that a distribution with support in a set K is expressible as the sum of iterated partial derivatives of finite complex Borel measures supported in K .

8. This problem classifies distributions on \mathbb{R}^1 supported at $\{0\}$. By Proposition 3.5f let η be a member of $C_{\text{com}}^\infty(\mathbb{R}^1)$ with values in $[0, 1]$ that is identically 1 for $|x| \leq \frac{1}{2}$ and is 0 for $|x| \geq 1$. Suppose that T is a distribution with support at $\{0\}$. Choose constants C , M , and n such that $|\langle T, \varphi \rangle| \leq C \sum_{k=0}^n \sup_{|x| \leq M} |D^k \varphi(x)|$ for all φ in $C^\infty(\mathbb{R}^1)$.
- (a) For $\varepsilon > 0$, define $\eta_\varepsilon(x) = \eta(\varepsilon^{-1}x)$. Prove for each $k \geq 0$ that there is a constant C_k independent of ε such that $\sup_x |(\frac{d}{dx})^k \eta_\varepsilon(x)| \leq C_k \varepsilon^{-k}$.

- (b) Using the assumption that T has support at $\{0\}$, prove that $\langle T, \varphi \rangle = \langle T, \eta_\varepsilon \varphi \rangle$ for every φ in $C^\infty(\mathbb{R}^1)$.
- (c) Suppose that φ is of the form $\varphi(x) = \psi(x)x^{n+1}$ with ψ in $C^\infty(\mathbb{R}^1)$. By applying (b) and estimating $|\langle T, \eta_\varepsilon \varphi \rangle|$ by means of the Leibniz rule and (a), prove that this special kind of φ has $T(\varphi) = 0$.
- (d) Using a Taylor expansion involving derivatives through order n and a remainder term, prove for general φ in $C^\infty(\mathbb{R}^1)$ that $\langle T, \varphi \rangle$ is a linear combination of $\varphi(0), D^1\varphi(0), \dots, D^n\varphi(0)$, hence that T is a linear combination of $\delta, D^1\delta, \dots, D^n\delta$.
9. By suitably adapting the argument in the previous problem, show that every distribution on \mathbb{R}^N that is supported at $\{0\}$ is a finite linear combination of the distributions $D^\alpha\delta$, where δ is the Dirac distribution at 0.
10. Let the members x of \mathbb{R}^N be written as pairs (x', x'') with x' in \mathbb{R}^L and x'' in \mathbb{R}^{N-L} . Suppose that T is a compactly supported distribution on \mathbb{R}^N that is supported in \mathbb{R}^L . By using a Taylor expansion in the variables x'' with coefficients involving x' and by adapting the argument for the previous two problems, prove that T is a finite sum of the form $\langle T, \varphi \rangle = \sum_{|\alpha| \leq n} \langle T_\alpha, (D^\alpha \varphi)|_{\mathbb{R}^L} \rangle$, the sum being over multi-indices α involving only x'' variables and each T_α being in $\mathcal{E}'(\mathbb{R}^L)$. (Educational note: The operators D^α of this kind are called **transverse derivatives** to \mathbb{R}^L . The result is that T is a finite sum of transverse derivatives of compactly supported distributions on \mathbb{R}^L .)
11. Using the result of Problem 9, prove the following uniqueness result to accompany Corollary 5.23: if f is a distribution of compact support in \mathbb{R}^N with $N > 2$, then any two tempered distributions u on \mathbb{R}^N that solve $\Delta u = f$ differ by a polynomial function annihilated by Δ . Is this uniqueness still valid if u is allowed to be *any* distribution that solves $\Delta u = f$?

Problems 12–13 introduce a notion of **periodic distribution** as any continuous linear functional on the space of periodic smooth functions on \mathbb{R}^N . Write T for the circle $\mathbb{R}/2\pi\mathbb{Z}$, and let $C^\infty(T^N)$ be the complex vector space of all smooth functions on \mathbb{R}^N that are periodic of period 2π in each variable. Regard $C^\infty(T^N)$ as a vector subspace of $C^\infty((-2\pi, 2\pi)^N)$, and give it the relative topology. Then define $\mathcal{P}'(T^N)$ to be the space of restrictions to $C^\infty(T^N)$ of members of $\mathcal{E}'((-2\pi, 2\pi)^N)$. For S in $\mathcal{P}'(T^N)$, define the **Fourier series** of S to be the trigonometric series $\sum_{k \in \mathbb{Z}^N} c_k e^{ik \cdot x}$ with $c_k = \langle S, e^{-ik \cdot x} \rangle$.

12. Prove that the Fourier coefficients c_k for such an S satisfy $|c_k| \leq C(1 + |k|^2)^{m/2}$ for some constant C and positive integer m .
13. Prove that any trigonometric series $\sum_{k \in \mathbb{Z}^N} c_k e^{ik \cdot x}$ in which the c_k 's satisfy $|c_k| \leq C(1 + |k|^2)^{m/2}$ for some constant C and positive integer m is the Fourier series of some member S of $\mathcal{P}'(T^N)$.

Problems 14–19 establish the **Schwartz Kernel Theorem** in the setting of periodic

functions. We make use of Problems 25–34 in Chapter III concerning Sobolev spaces $L_k^2(T^N)$ of periodic functions. As a result of those problems, the metric on $C^\infty(T^N)$ may be viewed as given by the separating family of seminorms $\|\cdot\|_{L_k^2(T^N)}$, $k \geq 0$, and $C^\infty(T^N)$ is a complete metric space. The Schwartz Kernel Theorem says that any bilinear function $B : C^\infty(T^N) \times C^\infty(T^N) \rightarrow \mathbb{C}$ that is separately continuous in the two variables is given by “integration with” a distribution on $T^N \times T^N \cong T^{2N}$. The analogous assertion about signed measures is false.

14. Let $B : C^\infty(T^N) \times C^\infty(T^N) \rightarrow \mathbb{C}$ be a function that is bilinear in the sense of being linear in each argument when the other argument is fixed, and suppose that B is continuous in each variable. The continuity in the first variable means that for each $\psi \in C^\infty(T^N)$, there is an integer k and there is some constant $C_{\psi,k}$ such that $|B(\varphi, \psi)| \leq C_{\psi,k} \|\varphi\|_{L_k^2(T^N)}$ for all $\varphi \in C^\infty(T^N)$, and a similar inequality governs the behavior in the ψ variable for each φ . For integers $k \geq 0$ and $M \geq 0$, define

$$E_{k,M} = \{\psi \in C^\infty(T^N) \mid |B(\varphi, \psi)| \leq M \|\varphi\|_{L_k^2(T^N)} \text{ for all } \varphi \in C^\infty(T^N)\}.$$

- (a) Prove that each $E_{k,M}$ is closed and that the union of these sets on k and M is $C^\infty(T^N)$.
 (b) Apply the Baire Category Theorem, and prove as a consequence that there exist an integer $k \geq 0$ and a constant C such that

$$|B(\varphi, \psi)| \leq C \|\varphi\|_{L_k^2(T^N)} \|\psi\|_{L_k^2(T^N)}$$

for all φ and ψ in $C^\infty(T^N)$.

15. Let B be as in Problem 14, and suppose that k and C are chosen as in Problem 14b. Fix an integer $K > N/2$, and define $k' = k + K$. Prove that

$$|B(D^\alpha \varphi, D^\beta \psi)| \leq C \|\varphi\|_{L_{k'}^2(T^N)} \|\psi\|_{L_{k'}^2(T^N)}$$

for all φ and ψ in $C^\infty(T^N)$ and all multi-indices α and β with $|\alpha| \leq K$ and $|\beta| \leq K$.

16. Let B, C, K , and k' be as in Problem 15. Put $b_{lm} = B(e^{il \cdot (\cdot)}, e^{im \cdot (\cdot)})$ for l and m in \mathbb{Z}^N , and for each pair of multi-indices (α, β) with $|\alpha| \leq k'$ and $|\beta| \leq k'$, define

$$F_{\alpha,\beta}(x, y) = \sum_{l,m \in \mathbb{Z}^N} \frac{b_{lm} (-i)^{|\alpha|+|\beta|} l^\alpha m^\beta e^{-il \cdot x} e^{-im \cdot y}}{\left(\sum_{|\alpha'| \leq k'} l^{2\alpha'} \right) \left(\sum_{|\beta'| \leq k'} m^{2\beta'} \right)}$$

for $(x, y) \in T^N \times T^N$. Prove that this series is convergent in $L^2(T^N \times T^N)$.

17. With B , C , K , and k' be as in Problem 15 and with $F_{\alpha,\beta}$ as in Problem 16 for $|\alpha| \leq k'$ and $|\beta| \leq k'$, define

$$B'(\varphi, \psi) = \sum_{\substack{|\alpha| \leq k' \\ |\beta| \leq k'}} (2\pi)^{-2N} \int_{[-\pi, \pi]^N \times [-\pi, \pi]^N} F_{\alpha,\beta}(x, y) (D^\alpha \varphi)(x) (D^\beta \psi)(y) dx dy$$

for φ and ψ in $C^\infty(T^N)$. Prove that B' is well defined for all φ and ψ in $C^\infty(T^N)$ and that $B'(e^{il \cdot(\cdot)}, e^{im \cdot(\cdot)}) = B(e^{il \cdot(\cdot)}, e^{im \cdot(\cdot)})$ for all l and m in \mathbb{Z}^N .

18. With B' as in the previous problem, prove that $B'(\varphi, \psi) = B(\varphi, \psi)$ for all φ and ψ in $C^\infty(T^N)$, and conclude that there exists a distribution S in $\mathcal{P}'(T^{2N})$ such that

$$B(\varphi, \psi) = \langle S, \varphi \otimes \psi \rangle$$

for all φ and ψ in $C^\infty(T^N)$ if $\varphi \otimes \psi$ is defined by $(\varphi \otimes \psi)(x, y) = \varphi(x)\psi(y)$.

19. Let η be a function in $C_{\text{com}}^\infty(\mathbb{R}^1)$ with values in $[0, 1]$ that is 1 for $|x| \leq \frac{1}{2}$ and is 0 for $|x| \geq 1$. For f continuous on T^1 , the Hilbert transform

$$(H(\eta f))(x) = \lim_{\varepsilon \downarrow 0} \frac{1}{\pi} \int_{|y| \geq \varepsilon} \frac{\eta(x-y)f(x-y) dy}{y}$$

exists as an $L^2(\mathbb{R}^1)$ limit.

- (a) Let $C(T^1)$ be the space of continuous periodic functions on \mathbb{R} of period 2π , and give it the supremum norm. Taking into account that H , as an operator from $L^2(\mathbb{R}^1)$ to itself, has norm 1, prove that

$$B(f, g) = \int_{-\pi}^{\pi} (H(\eta f))(x) (\eta g)(x) dx$$

is bilinear on $C(T^1) \times C(T^1)$ and is continuous in each variable.

- (b) Prove that there is no complex Borel measure $\rho(x, y)$ on $[-\pi, \pi]^2$ such that $B(f, g) = \int_{[-\pi, \pi]^2} f(x)g(y) d\rho(x, y)$ for all f and g in $C(T^1)$.

CHAPTER VI

Compact and Locally Compact Groups

Abstract. This chapter investigates several ways that groups play a role in real analysis. For the most part the groups in question have a locally compact Hausdorff topology.

Section 1 introduces topological groups, their quotient spaces, and continuous group actions. Topological groups are groups that are topological spaces in such a way that multiplication and inversion are continuous. Their quotient spaces by subgroups are of interest when they are Hausdorff, and this is the case when the subgroups are closed. Many examples are given, and elementary properties are established for topological groups and their quotients by closed subgroups.

Sections 2–4 investigate translation-invariant regular Borel measures on locally compact groups and invariant measures on their quotient spaces. Section 2 deals with existence and uniqueness in the group case. A left Haar measure on a locally compact group G is a nonzero regular Borel measure invariant under left translations, and right Haar measures are defined similarly. The theorem is that left and right Haar measures exist on G , and each kind is unique up to a scalar factor. Section 3 addresses the relationship between left Haar measures and right Haar measures, which do not necessarily coincide. The relationship is captured by the modular function, which is a certain continuous homomorphism of the group into the multiplicative group of positive reals. The modular function plays a role in constructing Haar measures for complicated groups out of Haar measures for subgroups. Of special interest are “unimodular” locally compact groups G , i.e., those for which the left Haar measures coincide with the right Haar measures. Every compact group, and of course every locally compact abelian group, is unimodular. Section 4 concerns translation-invariant measures on quotient spaces G/H . For the setting in which G is a locally compact group and H is a closed subgroup, the theorem is that G/H has a nonzero regular Borel measure invariant under the action of G if and only if the restriction to H of the modular function of G coincides with the modular function of H . In this case the G invariant measure is unique up to a scalar factor. Section 5 introduces convolution on unimodular locally compact groups G . Familiar results valid for the additive group of Euclidean space, such as those concerning convolution of functions in various L^p classes, extend to be valid for such groups G .

Sections 6–8 concern the representation theory of compact groups. Section 6 develops the elementary theory of finite-dimensional representations and includes some examples, Schur orthogonality, and properties of characters. Section 7 contains the Peter–Weyl Theorem, giving an orthonormal basis of L^2 in terms of irreducible representations and concluding with an Approximation Theorem showing how to approximate continuous functions on a compact group by trigonometric polynomials. Section 8 shows that infinite-dimensional unitary representations of compact groups decompose canonically according to the irreducible finite-dimensional representations of the group. An example is given to show how this theorem may be used to take advantage of the symmetry in analyzing a bounded operator that commutes with a compact group of unitary operators. The same principle applies in analyzing partial differential operators.

1. Topological Groups

The theme of this chapter is the interaction of real analysis with groups. We shall work with topological groups, their quotients, and continuous group actions, all of which are introduced in this section. A **topological group** is a group G with a Hausdorff topology such that multiplication, as a mapping $G \times G \rightarrow G$, and inversion, as a mapping $G \rightarrow G$, are continuous. A **homomorphism** of topological groups is a continuous group homomorphism. An **isomorphism** of topological groups is a group isomorphism that is a homeomorphism of topological spaces.

EXAMPLES.

- (1) Any **discrete group**, i.e., any group with the discrete topology.
- (2) The additive group \mathbb{R} or \mathbb{C} with the usual metric topology. The group operation is addition, and the inversion operation is negation.
- (3) The multiplicative groups $\mathbb{R}^\times = \mathbb{R} - \{0\}$ and $\mathbb{C}^\times = \mathbb{C} - \{0\}$, with the relative topology from \mathbb{R} or \mathbb{C} .
- (4) Any subgroup of a topological group, with the relative topology. Thus, for example, the circle $\{z \in \mathbb{C} \mid |z| = 1\}$ is a subgroup of \mathbb{C}^\times .
- (5) Any product of topological groups, with the product topology. Thus, for example, the additive groups \mathbb{R}^N and \mathbb{C}^N are topological groups. So is the countable product of two-element groups, each with the discrete topology; in this case the topological space in question is homeomorphic to the standard Cantor set in $[0, 1]$.
- (6) The **general linear group** $GL(N, \mathbb{C})$ of all nonsingular N -by- N complex matrices, with matrix multiplication as group operation. The topology is the relative topology from \mathbb{C}^{N^2} . Each entry in a matrix product is a polynomial in the $2N^2$ entries of the two matrices being multiplied and is therefore continuous; thus matrix multiplication is continuous. Inversion is defined on the set where the determinant polynomial is not 0 and is given, according to Cramer's rule, in each entry by the quotient of a polynomial function and the determinant function; thus inversion is continuous. By (4), the general linear group $GL(N, \mathbb{R})$ is a topological group.
- (7) The additive group of any topological vector space in the sense of Section IV.1. The additive groups of normed linear spaces are special cases.

In working with topological groups, we shall use expressions like

$$\begin{aligned} aU &= \{au \mid u \in U\} & \text{and} & & Ub &= \{ub \mid u \in U\}, \\ U^{-1} &= \{u^{-1} \mid u \in U\} & \text{and} & & UV &= \{uv \mid u \in U, v \in V\}. \end{aligned}$$

In any topological group every left translation $y \mapsto xy$ and every right translation $y \mapsto yx$ is a homeomorphism. The continuity of each translation follows by restriction from the continuity of multiplication, and the continuity of the inverse of a translation follows because the inverse of a translation is translation by the inverse element. For an abstract topological group, we write 1 for the identity element.

Continuity of the multiplication mapping $G \times G \rightarrow G$ at $(1, 1)$ implies, for any open neighborhood V of the identity in G , that there is an open neighborhood U of the identity for which $UU \subseteq V$. Inversion, being a continuous operation of order two, carries open sets to open sets; therefore if U is an open neighborhood of the identity, so is $U \cap U^{-1}$. Combining these facts, we see that if V is an open neighborhood of the identity, then there is an open neighborhood U of the identity such that $UU^{-1} \subseteq V$.

Conversely if whenever V is an open neighborhood of the identity, there is an open neighborhood U of the identity such that $UU^{-1} \subseteq V$, then it follows that the mapping $(x, y) \mapsto xy^{-1}$ is continuous at $(x, y) = (1, 1)$. If also all translations are homeomorphisms, then $(x, y) \mapsto xy^{-1}$ is continuous, and it follows easily that $x \mapsto x^{-1}$ and $(x, y) \mapsto xy$ are continuous.

Proposition 6.1. If G is a topological group, then G is regular as a topological space.

PROOF. We are to separate by disjoint open sets a point x and a closed set F with $x \notin F$. Since translations are homeomorphisms, we may assume x to be 1 . Then $V = F^c$ is an open neighborhood of 1 , and we can choose an open neighborhood U of 1 such that $UU \subseteq V$. Let us see that $U^{\text{cl}} \subseteq V$. From $UU \subseteq V$ and $1 \in U$, we have $U \subseteq V$. Thus let y be in $U^{\text{cl}} - U$. Since y is then a limit point of U and since $U^{-1}y$ is an open neighborhood of y , $U^{-1}y$ meets U . If z is in $U^{-1}y \cap U$, then $z = u^{-1}y$ for some u in U , and so $y = uz$ is in $UU \subseteq V$. Thus $U^{\text{cl}} \subseteq V$ and $U^{\text{cl}} \cap F = \emptyset$. Consequently G is regular. \square

If H is a subgroup of G , then the **quotient space** G/H of **left cosets** aH results from the equivalence relation that $a \sim b$ if there is some h in H with $a = bh$. The quotient space is given the quotient topology. Quotient spaces of topological groups are sometimes called **homogeneous spaces**.

Proposition 6.2. Let G be a topological group, let H be a *closed* subgroup, and let $q : G \rightarrow G/H$ be the quotient map. Then q is an open map, and G/H is a Hausdorff regular space such that the action of G on G/H given by $(g, aH) \mapsto (ga)H$ is continuous. Moreover,

- (a) G separable implies G/H separable,
- (b) G locally compact implies G/H locally compact,

- (c) G is compact if and only if H and G/H are compact,
- (d) H normal in the group-theoretic sense implies that G/H is a topological group.

PROOF. Let U be open. To show that $q(U)$ is open, we are to show that $q^{-1}(q(U))$ is open. But $q^{-1}(q(U)) = \bigcup_{h \in H} Uh$, which is open, being the union of open sets. Hence q is open.

To consider the action of G on H , we start from the continuous open mapping $1 \times q : G \times G \rightarrow G \times (G/H)$ given by $(g, a) \mapsto (g, aH)$. This descends to a well-defined one-one mapping $\tilde{q} : (G \times G)/(1 \times H) \rightarrow G \times (G/H)$ given by $(g, a)(1 \times H) \mapsto (g, aH)$, and the quotient topology is defined in such a way that this is continuous. The image under \tilde{q} of an open set is the same as the image under $1 \times q$ of the same open set, and this is open. Therefore \tilde{q} is a homeomorphism.

The mapping $(g, a) \mapsto (ga)H$ is the composition of multiplication $(g, a) \mapsto ga$ followed by q and is therefore continuous. Hence it descends to a continuous map $(g, a)(1 \times H) \mapsto (ga)H$. If \tilde{q}^{-1} is followed by this continuous map, the resulting map is $(g, aH) \mapsto (ga)H$, which is the action of G on G/H . Hence the action is continuous.

To see that G/H is regular, we are to separate by disjoint open sets a point x in G/H and a closed set F with $x \notin F$. The continuity of the action shows that we may assume x to be $1H$. Then $M = F^c$ is an open neighborhood of $1H$ in G/H , and the continuity of the action at $(1, 1H)$ shows that we can choose an open neighborhood U of 1 in G and an open neighborhood N of $1H$ in G/H such that $UN \subseteq M$. Let us see that $N^{\text{cl}} \subseteq M$. Using the identity element of U , we see that $N \subseteq M$. Thus let y be in $N^{\text{cl}} - N$. Since y is then a limit point of N and since $U^{-1}y$ is an open neighborhood of y (q being open), $U^{-1}y$ meets N . If z is in $U^{-1}y \cap N$, then $z = u^{-1}y$ for some u in U , and so $y = uz$ is in $UN \subseteq M$. Thus $N^{\text{cl}} \subseteq M$ and $N^{\text{cl}} \cap F = \emptyset$. Consequently G/H is regular.

To see that G/H is Hausdorff, consider the inverse image under q of a coset xH . This inverse image is xH as a subset of G , and this subset is closed in G since H is closed and translations are homeomorphisms. Thus G/H is \mathbf{T}_1 , as well as regular, and consequently it is Hausdorff.

Conclusion (a) follows from the fact that q is open, since the image under q of a countable base of open sets is therefore a countable base for G/H . Conclusion (b) is similarly immediate; the image of a compact neighborhood of a point is a compact neighborhood of the image point.

In (c), let G be compact. Then H is compact as a closed subset of a compact set, and G/H is compact as the continuous image of a compact set. In the converse direction let \mathcal{U} be an open cover of G . For each x in G , \mathcal{U} is an open cover of the subset xH of G , which is compact since it is homeomorphic to H . Let \mathcal{V}_x be a

finite subcover of xH , and let

$$V_x = \{y \in G \mid yH \text{ is covered by } \mathcal{V}_x\}.$$

We show that V_x is open in G . Let W_x be the open union of the members of \mathcal{V}_x . If y is in V_x , then yh is in W_x for all h in H . For each such h , we use the continuity of multiplication to find open neighborhoods U_h of 1 and N_h of h in G such that $U_h y N_h \subseteq W_x$. As h varies, the sets N_h cover H . If $\{N_{h_1}, \dots, N_{h_m}\}$ is a finite subcover, then each set $(U_{h_1} \cap \dots \cap U_{h_m}) y N_{h_j}$ lies in W_x and hence so does $(U_{h_1} \cap \dots \cap U_{h_m}) y H$. Thus $(U_{h_1} \cap \dots \cap U_{h_m}) y$ lies in V_x , and V_x is open.

The definition of V_x makes $V_x H = V_x$, and thus $q^{-1} q V_x = X_x$. The open sets V_x together cover G , and hence the open sets $q V_x$ cover G/H . Since G/H is compact, some finite subcollection $\{q V_{x_1}, \dots, q V_{x_n}\}$ covers G/H . The equality $q^{-1} q V_{x_j} = V_{x_j}$ for all j implies that $\{V_{x_1}, \dots, V_{x_n}\}$ is an open cover of G . Then $\bigcup_{j=1}^n \mathcal{V}_{x_j}$ is a finite subcollection of \mathcal{U} that covers G . This proves (c).

In (d), suppose that H is group-theoretically normal, and let V be an open neighborhood of 1 in G/H . Choose, by the continuity of the action on G/H , an open neighborhood U of 1 in G and an open neighborhood N of $1H$ in G/H such that $UN \subseteq V$. Then qU and N are open neighborhoods of the identity in G/H such that $(qU)N \subseteq V$. Hence multiplication in G/H is continuous at $(1, 1)$. Since the map $G \rightarrow G/H$ given for fixed aH by $g \mapsto (ga)H$ is continuous, the descended map $gH \mapsto (gH)(aH)$ is continuous. Thus left translations are continuous on G/H , and multiplication on G/H is continuous everywhere. To see continuity of inversion on G/H , let V be an open neighborhood of 1 in G/H , and let U be an open neighborhood of 1 in G with $U^{-1} \subseteq q^{-1}(V)$. Then $q(U^{-1}) \subseteq V$, and inversion is continuous at the identity. Since left and right translations are continuous on G/H , inversion is continuous everywhere. This completes the proof. \square

Proposition 6.3. If G is a topological group, then

- (a) any open subgroup H of G is closed and the quotient G/H has the discrete topology,
- (b) any discrete subgroup H of G (i.e., any subgroup whose relative topology is the discrete topology) is closed.

REMARK. Despite (a), a closed subgroup need not be open. For example, the closed subgroup \mathbb{Z} of integers is not open in the additive group \mathbb{R} .

PROOF. For (a), if H is an open subgroup, then every subset xH of G is open in G . Then the formula $H = G - \bigcup_{x \notin H} xH$ shows that H is closed. Also, since $G \rightarrow G/H$ is an open map, the openness of the subset xH of G implies that every one-element set $\{xH\}$ in G/H is open. Thus G/H has the discrete topology.

For (b), choose by discreteness an open neighborhood V of 1 in G such that $H \cap V = \{1\}$. By continuity of multiplication, choose an open neighborhood U of 1 with $UU \subseteq V$. If H is not closed, let x be a limit point of H that is not in H . Then the neighborhood $U^{-1}x$ of x must contain a member h of H , and h cannot equal x since x is not in H . Write $u^{-1}x = h$ with $u \in U$. Then $u = xh^{-1}$ is a limit point of H that is not in H , and we can find $h' \neq 1$ in H such that h' is in Uu . But $Uu \subseteq UU \subseteq V$, and so h' is in $H \cap V = \{1\}$, contradiction. We conclude that H contains all its limit points and is therefore closed. \square

A **compact group** is a topological group whose topology is compact Hausdorff. Similarly a **locally compact group** is a topological group whose topology is locally compact Hausdorff. Among the examples at the beginning of this section, the following are locally compact: any group with the discrete topology, the additive groups \mathbb{R} and \mathbb{C} , the multiplicative groups \mathbb{R}^\times and \mathbb{C}^\times , the circle as a subgroup of \mathbb{C}^\times , the additive groups \mathbb{R}^N and \mathbb{C}^N , the general linear groups $GL(N, \mathbb{R})$ and $GL(N, \mathbb{C})$, and the additive groups of finite-dimensional topological vector spaces. An arbitrary direct product of compact groups, with the product topology, is a compact group. Similarly any *finite* direct product of locally compact groups is a locally compact group.

A number of interesting subgroups of $GL(N, \mathbb{R})$ and $GL(N, \mathbb{C})$ are defined as the sets of matrices where certain polynomials vanish. Since polynomials are continuous, these subgroups are closed in $GL(N, \mathbb{R})$ or $GL(N, \mathbb{C})$. The next proposition says that they provide further examples of locally compact groups.

Proposition 6.4. Any closed subgroup of a locally compact group is a locally compact in the relative topology.

PROOF. Let G be the given locally compact group, and let H be the closed subgroup. As a subgroup of a topological group, H is a topological group. For local compactness, choose a compact neighborhood U_h in G of any element h of H . Then $U_h \cap H$ is a compact set in H since H is closed, and it is a neighborhood of h in the relative topology. Thus h has a compact neighborhood, and H is a locally compact group. \square

EXAMPLES OF CLOSED SUBGROUPS OF $GL(N, \mathbb{R})$ AND $GL(N, \mathbb{C})$.

(1) Affine group of the line. This consists of all matrices $\begin{pmatrix} a & b \\ 0 & 1 \end{pmatrix}$ with a and b real and with $a > 0$.

(2) Upper triangular group over \mathbb{R} or \mathbb{C} . This consist of all matrices whose entries on the diagonal are all nonzero, whose entries above the diagonal are arbitrary, and whose entries below the diagonal are 0.

(3) Commutator subgroup of previous example. This consists of all matrices whose entries on the diagonal are all 1, whose entries above the diagonal are arbitrary in \mathbb{R} or \mathbb{C} , and whose entries below the diagonal are 0.

(4) Special linear group $SL(N, \mathbb{F})$ with \mathbb{F} equal to \mathbb{R} or \mathbb{C} . This consists of all N -by- N matrices with determinant 1.

(5) Symplectic group $Sp(N, \mathbb{F})$ with \mathbb{F} equal to \mathbb{R} or \mathbb{C} . This consists of all $2N$ -by- $2N$ matrices g with determinant 1 such that $g^{\text{tr}} \begin{pmatrix} 0 & 1_N \\ -1_N & 0 \end{pmatrix} g = \begin{pmatrix} 0 & 1_N \\ -1_N & 0 \end{pmatrix}$.

(6) Unitary group $U(N)$. This consists of all N -by- N complex matrices g that are **unitary** in the sense that $\bar{g}^{\text{tr}} g = 1$. The group is compact; the compactness of the topology follows since the members of $U(N)$ form a closed bounded subset of a Euclidean space. The group $SU(N)$ is the subgroup of all g in $U(N)$ with determinant 1; it is a closed subgroup of $U(N)$ and hence is compact.

(7) Orthogonal group $O(N)$ and rotation group $SO(N)$. The group $O(N)$ consists of all N -by- N real matrices that are **orthogonal** in the sense that $g^{\text{tr}} g = 1$; it is the intersection¹ of the unitary group $U(N)$ with $GL(n, \mathbb{R})$. Members of $O(N)$ have determinant ± 1 . The subgroup $SO(N)$ consists of those members of $O(N)$ with determinant 1, i.e., the **rotations**. The groups $O(N)$ and $SO(N)$ are compact.

Proposition 6.5. If G is a locally compact group, then

- (a) any compact neighborhood V of 1 with $V = V^{-1}$ has the property that $H = \bigcup_{n=1}^{\infty} V^n$ is a σ -compact open subgroup,
- (b) G is normal as a topological space.

PROOF. The set V^n is the result of applying the multiplication mapping to $V \times \cdots \times V$ with n factors. This mapping is continuous, and hence V^n is compact. Thus H is σ -compact. Since $V^n V^m = V^{m+n}$, H is closed under multiplication. Since $V = V^{-1}$, we have $V^n = (V^{-1})^n = (V^n)^{-1}$, and H is closed under inversion. Thus H is a subgroup. Since V is a neighborhood of 1, Vx is a neighborhood of x . Therefore V^{n+1} is a neighborhood of each member of V^n , and H is open. This proves (a).

Let H be as in (a). The subspace H of G is σ -compact and hence Lindelöf, and Tychonoff's Lemma² shows that it is normal as a topological subspace. Let $\{x_\alpha\}$ be a complete system of coset representatives for H in G , so that $G = \bigcup_\alpha x_\alpha H$ is exhibited as the disjoint union of open closed sets, each of which is topologically normal. If E and F are disjoint closed sets in G , then $E \cap x_\alpha H$ and $F \cap x_\alpha H$ are disjoint closed sets in $x_\alpha H$. Hence there exist disjoint open sets U_α and V_α in $x_\alpha H$ such that $E \cap x_\alpha H \subseteq U_\alpha$ and $F \cap x_\alpha H \subseteq V_\alpha$. Then $U = \bigcup_\alpha U_\alpha$ and

¹This fact provides justification for using the term "unitary" in Proposition 2.6 even when $\mathbb{F} = \mathbb{R}$.

²Proposition 10.9 of *Basic*.

$V = \bigcup_{\alpha} V_{\alpha}$ are disjoint open sets in G such that $E \subseteq U$ and $F \subseteq V$. This proves (b). \square

The final proposition of the section shows that members of $C_{\text{com}}(G)$ are uniformly continuous in a certain sense that can be defined without the aid of a metric.

Proposition 6.6. If G is a locally compact group and f is in $C_{\text{com}}(G)$, then for any $\epsilon > 0$, there is an open neighborhood W of the identity with $W = W^{-1}$ such that $xy^{-1} \in W$ implies $|f(x) - f(y)| < \epsilon$.

PROOF. Let S be the support of f , and let $\epsilon > 0$ be given. For each y in S , let U_y be an open neighborhood of y such that $x \in U_y$ implies $|f(x) - f(y)| < \epsilon/2$. Since $U_y y^{-1}$ is a neighborhood of 1, we can find an open neighborhood V_y of 1 with $V_y = V_y^{-1}$ and $V_y V_y \subseteq U_y y^{-1}$. As y varies through S , the sets $V_y y$ form an open cover of S . Let $\{V_{y_1} y_1, \dots, V_{y_n} y_n\}$ be a finite subcover, and put $W = V_{y_1} \cap \dots \cap V_{y_n}$. This will be the required neighborhood of 1.

To see that W has the property asserted, let xy^{-1} be in W . If $f(x) = f(y) = 0$, then $|f(x) - f(y)| < \epsilon$. If $f(y) \neq 0$, then for some k , y is in $V_{y_k} y_k \subseteq U_{y_k} y_k^{-1} y_k = U_{y_k}$ and thus $|f(y_k) - f(y)| < \epsilon/2$. Also, $x = (xy^{-1})y$ is in $W V_{y_k} y_k \subseteq V_{y_k} V_{y_k} y_k \subseteq U_{y_k} y_k^{-1} y_k \subseteq U_{y_k}$ and thus $|f(x) - f(y_k)| < \epsilon/2$. Hence $|f(x) - f(y)| < \epsilon$. Finally if $f(x) \neq 0$, then $W = W^{-1}$ implies that yx^{-1} is in W , the roles of x and y are interchanged, and the proof that $|f(x) - f(y)| < \epsilon$ goes through as above. \square

Corollary 6.7. If G is a locally compact group and f is in $C_{\text{com}}(G)$, then the map of $G \times G$ into $C(G)$ given by $(g, g') \mapsto f(g(\cdot)g')$ is continuous.

PROOF. We first prove two special cases. If $g_0 \in G$ and $\epsilon > 0$ are given, then Proposition 6.6 produces an open neighborhood W of the identity such that $\sup_{x \in G} |f(gx) - f(g_0x)| < \epsilon$ for gg_0^{-1} in W , and hence $g \mapsto f(g(\cdot))$ is continuous. Applying this result to the function \tilde{f} given by $\tilde{f}(x) = f(x^{-1})$ and using continuity of the inversion map $x \mapsto x^{-1}$ within G , we see that $g' \mapsto f((\cdot)g')$ is continuous.

Now we reduce the general case to these two special cases. If (g_0, g'_0) is given in $G \times G$, then

$$\begin{aligned} |f(gxg') - f(g_0xg'_0)| &\leq |f(gxg') - f(g_0xg')| + |f(g_0xg') - f(g_0xg'_0)| \\ &\leq \sup_{x \in G} |f(gx) - f(g_0x)| + \sup_{x \in G} |f(xg') - f(xg'_0)|. \end{aligned}$$

The two special cases show that the right side tends to 0 as (g, g') tends to (g_0, g'_0) , and the corollary follows. \square

If G is a group and X is a set, a **group action** of G on X is a function $G \times X \rightarrow X$, often written $(g, x) \mapsto gx$, such that

- (i) $1x = x$ for all x in X ,
- (ii) $g_1(g_2x) = (g_1g_2)x$ for all x in X and all g_1 and g_2 in G .

If G is a topological group and X has a Hausdorff topology, a **continuous group action** is a group action such that the map $(g, x) \mapsto gx$ is continuous. In this case we say that G acts continuously on X . The fundamental example is the action of G on the quotient space G/H by a closed subgroup: $(g, g'H) \mapsto (gg')H$.

An **orbit** for a group action of G on X is any subset Gx of X . The action is **transitive** if there is just one orbit, i.e., if $Gx = X$ for some, or equivalently every, x in X . This is the situation with the fundamental example above. The action of the general linear group $GL(N, \mathbb{R})$ on \mathbb{R}^N by matrix multiplication is a continuous group action that is not transitive; it has two orbits, one open and the other closed.

Let G act continuously on X , fix x_0 in X , and let H be the subgroup of elements h in G with $hx_0 = x_0$. This is the **isotropy subgroup** at x_0 . It is a closed subgroup, being the inverse image in G of the closed set $\{x_0\}$ under the continuous function $g \mapsto gx_0$. Proposition 6.2 shows that the quotient topology on the set G/H of left cosets is Hausdorff. Since G/H has the quotient topology, the continuous map $G \rightarrow Gx_0$ given by $g \mapsto gx_0$ descends to a one-one continuous map $G/H \rightarrow Gx_0$. In favorable cases the map $G/H \rightarrow Gx_0$ is a homeomorphism with its image, and Problems 2–4 at the end of the chapter give sufficient conditions for it to be a homeomorphism. Sometimes the ability to do serious analysis on X depends on having the map be a homeomorphism. A case in which it is not a homeomorphism is the action of the discrete additive line G on the ordinary line $X = \mathbb{R}$ by translation.

2. Existence and Uniqueness of Haar Measure

The point of view in *Basic* in approaching the Riesz Representation Theorem for a locally compact Hausdorff space X was that the steps in the construction of Lebesgue measure work equally well with X . The only thing that is missing is some device to encode geometric data—to provide a generalization of length. That missing ingredient is captured by any positive linear functional on $C_{\text{com}}(X)$, but there is no universal source of interesting such functionals.

For the next few sections we shall impose additional structure on X , assuming now that X is a locally compact group in the sense of Section 1. We shall see in this case that a nonzero positive linear functional always exists with the property that it takes equal values on a function and any left translate of the function. In other words the positive linear functional has the same kind of invariance

property under translation as the Riemann integral. The corresponding regular Borel measure, which is Lebesgue measure in the case of the line, is called a (left) “Haar measure” and is the main object of study in Sections 2–5 of this chapter.

Several examples of locally compact groups were given in Section 1. Among them are the circle group, the additive group \mathbb{R}^N , and the general linear groups $GL(N, \mathbb{C})$ and $GL(N, \mathbb{R})$, which consist of all N -by- N nonsingular matrices and have matrix multiplication as the group operation. Proposition 6.4 showed that any closed subgroup of a locally compact group is itself a locally compact group. Special linear groups, unitary groups, orthogonal groups, and rotation groups are among the examples that were mentioned.

Thus let G be a locally compact group. We shall write the group multiplicatively except when we are dealing with special examples where a different notation is more suitable. Ordinarily no special symbol will be used for a translation map in G . Thus left translations are simply the homeomorphisms $x \mapsto gx$ for g in G , and right translations are the maps $x \mapsto xg$.

Let us consider these as special cases of what any continuous mapping does. The notation will be clearer if we distinguish the domain from the image. Thus let Φ be a continuous mapping of a locally compact Hausdorff space X into a locally compact Hausdorff space Y . The mapping Φ carries subsets of X to subsets of Y by the rule $\Phi(E) = \{\Phi(x) \mid x \in E\}$.

If Φ is a homeomorphism, it preserves the topological character of sets. Thus compact sets go to compact sets, G_δ 's go to G_δ 's, and so on. Consequently Borel sets map to Borel sets, and Baire sets map to Baire sets.

By contrast a scalar-valued function f on Y **pulls back** to the scalar-valued function f^Φ on X given by $f^\Phi(x) = f(\Phi(x))$, with continuity being preserved. A Borel measure μ on X **pushes forward** to a measure μ_Φ on Y given by $\mu_\Phi(E) = \mu(\Phi^{-1}(E))$; the measure μ_Φ is defined on Borel sets but need not be finite on compact sets. If Φ is a homeomorphism, however, then μ_Φ is a Borel measure, and regularity of μ implies regularity of μ_Φ .

Of great importance for current purposes is the effect of Φ on integration, where the effect is that of a change of variables. The formula is

$$\boxed{\int_X f^\Phi d\mu = \int_Y f d\mu_\Phi}$$

if f is a Borel function ≥ 0 , for example. To prove this formula, we first take f to be the indicator function I_E of a subset E of Y . On the left side we have $I_E^\Phi(x) = I_E(\Phi(x)) = I_{\Phi^{-1}(E)}(x)$. Hence the left side equals $\int_X I_E^\Phi d\mu = \mu(\Phi^{-1}(E)) = \mu^\Phi(E)$, which in turn equals the right side $\int_Y I_E d\mu_\Phi$. Linearity allows us to extend this conclusion to nonnegative simple functions, and monotone convergence allows us to pass to Borel functions ≥ 0 .

An important consequence of the boxed formula is the formula

$$(F d\mu)_\Phi = F^{\Phi^{-1}} d\mu_\Phi.$$

In fact, if we set $f = F^{\Phi^{-1}} I_E$ in the boxed formula, then we obtain $\int_X F I_E^\Phi d\mu = \int_Y F^{\Phi^{-1}} I_E d\mu_\Phi$. Thus $\int_{\Phi^{-1}(E)} F d\mu = \int_E F^{\Phi^{-1}} d\mu_\Phi$ and $(F d\mu)_\Phi(E) = (F d\mu)(\Phi^{-1}(E)) = \int_{\Phi^{-1}(E)} F d\mu = \int_E F^{\Phi^{-1}} d\mu_\Phi = (F^{\Phi^{-1}} d\mu_\Phi)(E)$.

The Euclidean change-of-variables formula³ is a special case of the boxed formula, and the content of the theorem amounts to an explicit identification of μ_Φ . Let $\varphi : U \rightarrow \varphi(U)$ be a diffeomorphism with $\det \varphi'(x)$ nowhere 0. If $y = \varphi(x)$, then the formula gives $dy = |\det \varphi'(x)| dx$. Since $dy = d(\varphi(x)) = (dx)_{\varphi^{-1}}$, the formula is saying that $(dx)_{\varphi^{-1}} = |\det \varphi'(x)| dx$. We recover the usual Euclidean integration formula by applying the boxed formula with $\Phi = \varphi^{-1}$, $X = \varphi(U)$, $Y = U$, $d\mu = dy$, and $d\mu_{\varphi^{-1}} = |\det \varphi'(x)| dx$, and then by letting $F = f^{\varphi^{-1}}$. The result is $\int_{\varphi(U)} F(y) dy = \int_U F(\varphi(x)) |\det \varphi'(x)| dx$, as it should be.

The rule for composition for points and sets is that $(\Psi \circ \Phi)(x) = \Psi(\Phi(x))$ and $(\Psi \circ \Phi)(E) = \Psi(\Phi(E))$. But for functions and measures the rules are $f^{\Psi \circ \Phi} = (f^\Psi)^\Phi$ and $\mu_{\Psi \circ \Phi} = (\mu_\Phi)^\Psi$. In other words, when Φ is followed by Ψ in operating on points and sets, Φ is again followed by Ψ in pushing forward measures, but Ψ is followed by Φ in pulling back functions. In the special case that $X = Y = G$, this feature will mean that certain expressions that we might want to write as triple products do not automatically satisfy an expected associativity property without some adjustment to the notation.

First consider left translation. On points, left translation L_h by h sends x to hx , and left translation by g sends this to $g(hx) = (gh)x$. The behavior on sets is similar. On functions and measures we therefore have $f^{L_{gh}} = f^{L_g L_h} = (f^{L_h})^{L_g}$ and $\mu_{L_{gh}} = \mu_{L_g L_h} = (\mu_{L_h})^{L_g}$. To obtain group actions on functions and measures, we therefore define

$$(gf)(x) = f^{L_g^{-1}}(x) = f(g^{-1}x) \quad \text{and} \quad (g\mu)(E) = \mu_{L_g}(E) = \mu(g^{-1}E)$$

for g in G . With these definitions we have $g(hf) = (gh)f$ and $g(h\mu) = (gh)\mu$, consistently with the formulas for a group action.

With right translation the effect on points is that right translation by h sends x to xh , and right translation by g sends this to $(xh)g = x(hg)$. The behavior on sets is similar. We want the same kind of formula with functions and measures, and to get it we define

$$(fg)(x) = f(xg^{-1}) \quad \text{and} \quad (\mu g)(E) = \mu(Eg^{-1})$$

³Theorem 6.32 of *Basic*.

for g in G . With these definitions we have $(fh)g = f(hg)$ and $(\mu h)g = \mu(hg)$. These are the formulas of what we might view as a “right group action.”

A nonzero regular Borel measure on G invariant under all left translations is called a **left Haar measure** on G . A **right Haar measure** on G is a nonzero regular Borel measure invariant under all right translations. The main theorem, whose proof will occupy much of the remainder of this section, is as follows.

Theorem 6.8. If G is a locally compact group, then G has a left Haar measure, and it is unique up to a multiplicative constant. Similarly G has a right Haar measure, and it is unique up to a multiplicative constant.

Before coming to the proof, we give some examples. Checking the invariance in each case involves using the boxed formula above for some homeomorphism Φ . In Euclidean situations we can often evaluate μ_Φ directly by the change-of-variables formula for multiple integrals. In an abelian group the left and right Haar measures are the same, and we speak simply of Haar measure; but this need not be true in nonabelian groups, as one of the examples will illustrate.

EXAMPLES.

(1) $G = \mathbb{R}^N$ under addition. Lebesgue measure is a Haar measure.

(2) $G = GL(N, \mathbb{R})$. Problem 4 in Chapter VI of *Basic* showed that if M_N is the N^2 -dimensional Euclidean space of all real N -by- N matrices and if dx refers to its Lebesgue measure, then

$$\int_{M_N} f(gx) \frac{dx}{|\det x|^N} = \int_{M_N} f(x) \frac{dx}{|\det x|^N}$$

for each nonsingular matrix g and Borel function $f \geq 0$. In the formula, gx is the matrix product of g and x . Problem 10 in the same chapter showed that the zero locus of any polynomial that is not identically zero has Lebesgue measure 0. Thus the set where $\det x = 0$ has measure 0, and we can rewrite the above formula as

$$\int_{GL(N, \mathbb{R})} f(gx) \frac{dx}{|\det x|^N} = \int_{GL(N, \mathbb{R})} f(x) \frac{dx}{|\det x|^N},$$

where dx is still Lebesgue measure on the underlying Euclidean space of all N -by- N matrices. This formula says that $\frac{dx}{|\det x|^N}$ is a left Haar measure on $GL(N, \mathbb{R})$. This measure happens to be also a right Haar measure.

(3) $G = \left\{ \begin{pmatrix} a & b \\ 0 & 1 \end{pmatrix} \right\}$ with real entries and $a > 0$. Then $a^{-2} da db$ is a left Haar measure and $a^{-1} da db$ is a right Haar measure. To check the first of these assertions, let φ be left translation by $\begin{pmatrix} a_0 & b_0 \\ 0 & 1 \end{pmatrix}$. Since $\begin{pmatrix} a_0 & b_0 \\ 0 & 1 \end{pmatrix} \begin{pmatrix} a & b \\ 0 & 1 \end{pmatrix} = \begin{pmatrix} a_0 a & a_0 b + b_0 \\ 0 & 1 \end{pmatrix}$,

we can regard φ as the vector function $\varphi \begin{pmatrix} a \\ b \end{pmatrix} = \begin{pmatrix} a_0 a \\ a_0 b + b_0 \end{pmatrix}$ with $\varphi' \begin{pmatrix} a \\ b \end{pmatrix} = \begin{pmatrix} a_0 & 0 \\ 0 & a_0 \end{pmatrix}$ and $|\det \varphi' \begin{pmatrix} a \\ b \end{pmatrix}| = a_0^2$. Then $(da db)_{\varphi^{-1}} = a_0^2 da db$ and $(a^{-2} da db)_{\varphi^{-1}} = (a^{-2})^\varphi (da db)_{\varphi^{-1}} = (a_0 a)^{-2} a_0^2 da db = a^{-2} da db$. So $a^{-2} da db$ is indeed a left Haar measure. By a similar argument, $a^{-1} da db$ is a right Haar measure.

We shall begin the proof of Theorem 6.8 with uniqueness. The argument will use Fubini's Theorem for certain Borel measures on G , and we need to make two adjustments to make Fubini's Theorem apply. One is to work with Baire sets, rather than Borel sets, so that the product σ -algebra from the Baire sets of G times the Baire sets of G is the σ -algebra of Baire sets for $G \times G$.⁴ The other is to arrange that the spaces we work with are σ -compact. The device for achieving the σ -compactness is Proposition 6.5, which shows that G always has an open σ -compact subgroup H . Imagine that we understand the restriction of a left Haar measure μ to H . We form the left cosets gH , all of which are open in G . Any compact set is covered by all these cosets, and there is a finite subcover. That means that any compact set K is contained in the union of finitely many cosets gH , say in $g_1 H \cup \dots \cup g_n H$. We can compute μ on any gH by translating the set by g^{-1} . This fact and the formula $\mu(K) = \sum_{j=1}^n \mu(K \cap g_j H)$ together show that we can compute $\mu(K)$ from a knowledge of μ on H . Thus there is no loss of generality in the uniqueness question in assuming that G is σ -compact.

PROOF OF UNIQUENESS IN THEOREM 6.8. As remarked above, G has a σ -compact open subgroup H , and it is enough to prove the uniqueness for H . Changing notation, we may assume that our given group is σ -compact. We work with Baire sets in this argument.

Let μ_1 and μ_2 be left Haar measures. Then the sum $\mu = \mu_1 + \mu_2$ is a left Haar measure, and $\mu(E) = 0$ implies $\mu_1(E) = 0$. By the Radon–Nikodym Theorem,⁵ there exists a Baire function $h_1 \geq 0$ such that $\mu_1 = h_1 d\mu$. Fix g in G . By the left invariance of μ_1 and μ , we have

$$\begin{aligned} \int_G f(x) h_1(g^{-1}x) d\mu(x) &= \int_G f(gx) h_1(x) d\mu(x) = \int_G f(gx) d\mu_1(x) \\ &= \int_G f(x) d\mu_1(x) = \int_G f(x) h_1(x) d\mu(x) \end{aligned}$$

for every Baire function $f \geq 0$. Therefore the measures $h_1(g^{-1}x) d\mu(x)$ and $h_1(x) d\mu(x)$ are equal, and $h_1(g^{-1}x) = h_1(x)$ for almost every $x \in G$ (with respect to $d\mu$). We can regard $h_1(g^{-1}x)$ and $h_1(x)$ as functions of $(g, x) \in G \times G$,

⁴Proposition 11.17 of *Basic*.

⁵Theorem 9.16 of *Basic*.

and these are Baire functions since the group operations are continuous. For each g , they are equal for almost every x . By Fubini's Theorem they are equal for almost every pair (g, x) (with respect to the product measure), and then for almost every x they are equal for almost every g . Pick one such x , say x_0 . Then it follows that $h_1(x) = h_1(x_0)$ for almost every x . Thus $d\mu_1 = h_1(x_0) d\mu$. So $d\mu_1$ is a multiple of $d\mu$, and so is $d\mu_2$. \square

Now we turn our attention to existence. The shortest and best-motivated known proof dates from 1940 and modifies Haar's original argument in two ways that we shall mention. First let us consider that original argument, in which the setting is a locally compact separable metric topological group. In trying to construct an invariant measure, there is not much to work with, the situation being so general. We can get an idea how to proceed by examining \mathbb{R}^N , where we are trying to construct Lebesgue measure out of almost nothing. We do have some rough comparisons of size because of the compactness. If we take a compact geometric rectangle and an open geometric rectangle, the latter centered at the origin, the compactness ensures that finitely many translates of the open rectangle together cover the compact rectangle. The smallest such number of translates is a rough estimate of the ratio of their Lebesgue measures. This integer estimate in some sense becomes more refined as the open rectangle gets smaller, but the integer in question grows in size also. To take this scaling factor into account, we compare this integer ratio with the integer ratio for some standard compact rectangle as the open rectangle gets small. This ratio of two integer ratios appears to be a good approximation to the ratio of the measure of the general compact rectangle to the measure of the standard compact rectangle. In fact, one easily shows that this ratio of ratios is bounded above and below as the open rectangle shrinks in size through a sequence of rectangles to a point. The Bolzano–Weierstrass Theorem gives a convergent subsequence for the ratio of ratios. It turns out that this convergence has to be addressed only for countably many of the compact rectangles, and this we can do by the Cantor diagonal process. Then we obtain a value for the measure of each compact rectangle in the countable set and, as a result, for all compact rectangles. It then has to be shown that we can build a measure out of this definition of the measure on compact rectangles.

Two things are done to modify the above argument to obtain a general proof for locally compact groups. One is to replace the Cantor diagonal process by an application of the Tychonoff Product Theorem. The other is to bypass the long process of constructing a measure on Borel sets from its values on compact sets by instead using positive linear functionals and applying the Riesz Representation Theorem. Once an initial comparison can be made with continuous functions of compact support, rather than compact sets and open sets, the path to the theorem is fairly clear. It is Lemma 6.9 below that says that the initial comparison can be

carried out with such functions. For a locally compact group G , let $C_{\text{com}}^+(G)$ be the set of nonnegative elements in $C_{\text{com}}(G)$.

Lemma 6.9. If f and φ are nonzero members of $C_{\text{com}}^+(G)$, then there exist a positive integer n , finitely many members g_1, \dots, g_n of G , and real numbers c_1, \dots, c_n all > 0 such that

$$f(x) \leq \sum_{j=1}^n c_j \varphi(g_j x) \quad \text{for all } x.$$

REMARK. We let $H(f, \varphi)$ be the infimum of all finite sums $\sum_j c_j$ as in the statement of the lemma. The expression $H(f, \varphi)$ is called the value of the **Haar covering function** at f and φ .

PROOF. Fix $c > \|f\|_{\text{sup}}/\|\varphi\|_{\text{sup}}$. The set $U = \{x \mid c\varphi(x) > \|f\|_{\text{sup}}\}$ is open and nonempty, and the sets hU , for $h \in G$, form an open cover of the support of f . Choose a finite subcover, writing

$$\text{support}(f) \subseteq h_1 U \cup \dots \cup h_n U.$$

For $1 \leq j \leq n$, we then have

$$\begin{aligned} h_j U &= \{x \mid h_j^{-1} x \in U\} = \{x \mid c\varphi(h_j^{-1} x) > \|f\|_{\text{sup}}\} \\ &\subseteq \{x \mid f(x) \leq \sum_{j=1}^n c\varphi(h_j^{-1} x)\}. \end{aligned}$$

Hence

$$\text{support}(f) \subseteq \{x \mid f(x) \leq \sum_{j=1}^n c\varphi(h_j^{-1} x)\}.$$

The lemma follows with $g_j = h_j^{-1}$ and with all c_j equal to c . \square

Lemma 6.10. The Haar covering function has the properties that

- (a) $H(gf, \varphi) = H(f, \varphi)$ for g in G ,
- (b) $H(f_1 + f_2, \varphi) \leq H(f_1, \varphi) + H(f_2, \varphi)$,
- (c) $H(cf, \varphi) = cH(f, \varphi)$ for $c > 0$,
- (d) $f_1 \leq f_2$ implies $H(f_1, \varphi) \leq H(f_2, \varphi)$,
- (e) $H(f, \psi) \leq H(f, \varphi)H(\varphi, \psi)$,
- (f) $H(f, \varphi) \geq \|f\|_{\text{sup}}/\|\varphi\|_{\text{sup}}$.

PROOF. Properties (a) through (d) are completely elementary. For (e), the inequalities $f(x) \leq \sum_i c_i \varphi(g_i x)$ and $\varphi(x) \leq \sum_j d_j \psi(h_j x)$ together imply that $f(x) \leq \sum_{i,j} c_i d_j \psi(h_j g_i x)$. Therefore

$$H(f, \psi) \leq \inf \sum_{i,j} c_i d_j = \left(\inf \sum_i c_i \right) \left(\inf \sum_j d_j \right) = H(f, \varphi)H(\varphi, \psi).$$

For (f), the fact that a continuous real-valued function on a compact set attains its maximum value allows us to choose y such that $f(y) = \|f\|_{\text{sup}}$. Then $\|f\|_{\text{sup}} = f(y) \leq \sum_j c_j \varphi(g_j y) \leq \sum_j c_j \|\varphi\|_{\text{sup}}$ and hence $\|f\|_{\text{sup}} / \|\varphi\|_{\text{sup}} \leq \sum_j c_j$. Taking the infimum over systems of constants c_j gives $\|f\|_{\text{sup}} / \|\varphi\|_{\text{sup}} \leq H(f, \varphi)$. \square

Following the outline above, we now perform the normalization. Fix a nonzero member f_0 of $C_{\text{com}}^+(G)$. If φ and f are nonzero members of $C_{\text{com}}^+(G)$, define

$$\ell_\varphi(f) = H(f, \varphi) / H(f_0, \varphi).$$

After listing some elementary properties of ℓ_φ , we shall prove in effect that ℓ_φ is close to being additive if the support of φ is small.

Lemma 6.11. $\ell_\varphi(f)$ has the properties that

- (a) $0 < \frac{1}{H(f_0, f)} \leq \ell_\varphi(f) \leq H(f, f_0)$,
- (b) $\ell_\varphi(gf) = \ell_\varphi(f)$ for g in G ,
- (c) $\ell_\varphi(f_1 + f_2) \leq \ell_\varphi(f_1) + \ell_\varphi(f_2)$,
- (d) $\ell_\varphi(cf) = c\ell_\varphi(f)$ if $c > 0$ is a constant.

PROOF. Properties (b), (c), and (d) are immediate from (a), (b), and (c) of Lemma 6.10. For (a), we apply Lemma 6.10e with φ there equal to f_0 and with ψ there equal to φ , and the resulting inequality is $H(f, \varphi) \leq H(f, f_0)H(f_0, \varphi)$. Thus $\ell_\varphi(f) \leq H(f, f_0)$. Then we apply Lemma 6.10e with f there equal to f_0 , φ there equal to f , and ψ there equal to φ . The resulting inequality is $H(f_0, \varphi) \leq H(f_0, f)H(f, \varphi)$. Thus $1/H(f_0, f) \leq \ell_\varphi(f)$. \square

Lemma 6.12. If f_1 and f_2 are nonzero members of $C_{\text{com}}^+(G)$ and if $\epsilon > 0$ is given, then there exists an open neighborhood V of the identity in G such that

$$\ell_\varphi(f_1) + \ell_\varphi(f_2) \leq \ell_\varphi(f_1 + f_2) + \epsilon$$

for every nonzero φ in $C_{\text{com}}^+(G)$ whose support is contained in V .

PROOF. Let K be the support of $f_1 + f_2$, and let F be a member of $C_{\text{com}}(G)$ with values in $[0, 1]$ such that F is 1 on K . The number $\epsilon > 0$ is given in the statement of the lemma, and we let δ be a positive number to be specified. Define $f = f_1 + f_2 + \delta F$, $h_1 = f_1/f$, and $h_2 = f_2/f$, with the convention that h_1 and h_2 are 0 on the set where f is 0.

The functions h_1 and h_2 are continuous: In fact, there is no problem on the open set where $f(x) \neq 0$. At a point x where $f(x) = 0$, the functions h_1 and h_2 are continuous unless x is a limit point of the set where $f_1 + f_2$ is not 0. This

set is contained in K , and thus x must be in K . On the other hand, F is 1 on K , and hence f is $\geq \delta$ on K . Hence there are no points x where h_1 or h_2 fails to be continuous.

Let $\eta > 0$ be another number to be specified. By Proposition 6.6 let V be an open neighborhood of the identity such that $V = V^{-1}$ and also

$$|h_1(x) - h_1(y)| < \eta \quad \text{and} \quad |h_2(x) - h_2(y)| < \eta$$

whenever xy^{-1} is in V . If $\varphi \in C_{\text{com}}^+(G)$ has support in V and if positive constants c_j and group elements g_j are chosen such that $f(x) \leq \sum_j c_j \varphi(g_j x)$ for all x , then every x for which $\varphi(g_j x) > 0$ has the property that

$$|h_1(g_j^{-1}) - h_1(x)| < \eta \quad \text{and} \quad |h_2(g_j^{-1}) - h_2(x)| < \eta.$$

Hence

$$f_1(x) = f(x)h_1(x) \leq \sum_j c_j \varphi(g_j x) h_1(x) \leq \sum_j (c_j (h_1(g_j^{-1}) + \eta)) \varphi(g_j x).$$

Consequently

$$H(f_1, \varphi) \leq \sum_j (c_j (h_1(g_j^{-1}) + \eta)).$$

Similarly

$$H(f_2, \varphi) \leq \sum_j (c_j (h_2(g_j^{-1}) + \eta)).$$

Adding, we obtain

$$H(f_1, \varphi) + H(f_2, \varphi) \leq \sum_j (c_j (h_1(g_j^{-1}) + h_2(g_j^{-1}) + 2\eta)) \leq \sum_j c_j (1 + 2\eta)$$

since $h_1 + h_2 \leq 1$. Taking the infimum over the c_j 's and the g_j 's gives

$$H(f_1, \varphi) + H(f_2, \varphi) \leq H(f, \varphi)(1 + 2\eta).$$

Therefore

$$\begin{aligned} & \ell_\varphi(f_1) + \ell_\varphi(f_2) \\ & \leq \ell_\varphi(f)(1 + 2\eta) \\ & \leq (\ell_\varphi(f_1 + f_2) + \delta \ell_\varphi(F))(1 + 2\eta) \quad \text{by (c) and (d) in Lemma 6.11} \\ & \leq \ell_\varphi(f_1 + f_2) + (\delta H(F, f_0) + 2\delta \eta H(F, f_0) + 2\eta H(f_1 + f_2, f_0)), \end{aligned}$$

the last inequality holding by Lemma 6.11a. This proves the inequality of the lemma if δ and η are chosen small enough that

$$\delta H(F, f_0) + 2\delta \eta H(F, f_0) + 2\eta H(f_1 + f_2, f_0) < \epsilon. \quad \square$$

Lemma 6.13. There exists a nonzero positive linear functional ℓ on $C_{\text{com}}(G)$ such that $\ell(f) = \ell(gf)$ for all $g \in G$ and $f \in C_{\text{com}}(G)$.

PROOF. For each nonzero f in $C_{\text{com}}^+(G)$, let S_f be the closed interval $[1/H(f_0, f), H(f, f_0)]$. Let S be the compact Hausdorff space

$$S = \prod_{\substack{f \in C_{\text{com}}^+(G), \\ f \neq 0}} S_f.$$

A member of S is a function that assigns to each nonzero member f of $C_{\text{com}}^+(G)$ a real number in the closed interval S_f , and $\ell_\varphi(f)$ is such a function, according to Lemma 6.11a. For each open neighborhood V of the identity in G , define

$$E_V = \{\ell_\varphi \mid \varphi \in C_{\text{com}}^+(G), \varphi \neq 0, \text{support}(\varphi) \subseteq V\}$$

as a nonempty subset of S . If $V \subseteq V'$, then $E_V \subseteq E_{V'}$ and hence also $E_V^{\text{cl}} \subseteq E_{V'}^{\text{cl}}$. Thus if V_1, \dots, V_n are open neighborhoods of the identity, then

$$E_{V_1 \cap \dots \cap V_n}^{\text{cl}} \subseteq E_{V_1}^{\text{cl}} \cap \dots \cap E_{V_n}^{\text{cl}}.$$

Consequently the closed sets E_V^{cl} have the finite-intersection property. Since S is compact, they have nonempty intersection. Let ℓ be a point of S lying in their intersection. For ℓ to be in E_V^{cl} for a particular V means that for each $\epsilon > 0$ and each finite set f_1, \dots, f_n of nonzero members of $C_{\text{com}}^+(G)$, there is a nonzero φ in $C_{\text{com}}^+(G)$ with support in V such that

$$|\ell(f_j) - \ell_\varphi(f_j)| < \epsilon \quad \text{for } 1 \leq j \leq n. \quad (*)$$

On the nonzero functions in $C_{\text{com}}^+(G)$, let us observe the following facts:

- (i) $\ell(f) \geq 0$ and $\ell(f_0) = 1$, the latter because $\ell_\varphi(f_0) = 1$ for all φ .
- (ii) $\ell(f) = \ell(gf)$ for $g \in G$, since for any $\epsilon > 0$, $|\ell(f) - \ell(gf)| \leq |\ell(f) - \ell_\varphi(f)| + |\ell_\varphi(f) - \ell_\varphi(gf)| + |\ell_\varphi(gf) - \ell(gf)| < 2\epsilon$ by Lemma 6.11b if V and φ are as in (*) for the two functions f and gf .
- (iii) $\ell(f_1 + f_2) = \ell(f_1) + \ell(f_2)$ because if $\epsilon > 0$ is given, if V is chosen for this ϵ according to Lemma 6.12, and if φ is chosen for f_1, f_2 , and f as in (*), then we have $\ell(f_1 + f_2) \leq \ell_\varphi(f_1 + f_2) + \epsilon \leq \ell_\varphi(f_1) + \ell_\varphi(f_2) + \epsilon \leq \ell(f_1) + \ell(f_2) + 3\epsilon$ and $\ell(f_1) + \ell(f_2) \leq \ell_\varphi(f_1) + \ell_\varphi(f_2) + 2\epsilon \leq \ell_\varphi(f_1 + f_2) + 3\epsilon \leq \ell(f_1 + f_2) + 4\epsilon$, the next-to-last inequality holding by Lemma 6.12.
- (iv) $\ell(cf) = c\ell(f)$ for $c > 0$ because if V and φ are as in (*) for $\epsilon > 0$ and the two functions f and cf , then we have $\ell(cf) \leq \ell_\varphi(cf) + \epsilon = c\ell_\varphi(f) + \epsilon \leq c\ell(f) + (c+1)\epsilon$ and $c\ell(f) \leq c\ell_\varphi(f) + c\epsilon = \ell_\varphi(cf) + c\epsilon \leq \ell(cf) + (c+1)\epsilon$.

Because of (iii) and (iv), ℓ extends to a linear functional on $C_{\text{com}}(G)$, and this linear functional is positive by (i) and satisfies the invariance condition $\ell(f) = \ell(gf)$ by (ii). \square

PROOF OF EXISTENCE IN THEOREM 6.8. Fix a nonzero function f_0 in $C_{\text{com}}^+(G)$, and let μ be the measure given by the Riesz Representation Theorem as corresponding to the positive linear functional ℓ in Lemma 6.13. If K_0 is a nonempty compact G_δ and if $\{f_n\}$ is a decreasing sequence in $C_{\text{com}}(G)$ with pointwise limit I_{K_0} , then we have $\int_G g f_n d\mu = \int_G f_n d\mu$ for all $g \in G$ and all n . Passing to the limit and applying dominated convergence gives $\int_G g I_{K_0} d\mu = \int_G I_{K_0} d\mu$. Now $g I_{K_0}(x) = I_{K_0}(g^{-1}x) = I_{gK_0}(x)$, and hence $\mu(gK_0) = \mu(K_0)$ for all g . In other words, the regular Borel measures $g^{-1}\mu$ and μ agree on compact G_δ 's. This equality is enough⁶ to force the equality $g^{-1}\mu = \mu$ for all g . Finally μ is not the 0 measure since $\int_G f_0 d\mu = 1$. \square

3. Modular Function

We continue with G as a locally compact group. From now on, we shall often denote particular left and right Haar measures on G by $d_l x$ and $d_r x$, respectively.

An important property of left and right Haar measures is that

any nonempty open set has nonzero Haar measure.

In fact, in the case of a left Haar measure, if any compact set is given, finitely many left translates of the given open set together cover the compact set. If the open set had 0 measure, so would its left translates and so would every compact set. Then the measure would be identically 0 by regularity. A similar argument applies to any right Haar measure. We shall occasionally make use of this property without explicit mention.

Actually, left Haar measure and right Haar measure have the same sets of measure 0, as will follow from Proposition 6.15c below. Thus we are completely justified in using the expression “nonzero Haar measure” above.

Fix a left Haar measure $d_l x$. Since left translations on G commute with right translations, $d_l(\cdot g)$ is a left Haar measure for any $g \in G$. Left Haar measures are proportional, and we therefore define the **modular function** $\Delta : G \rightarrow \mathbb{R}^+$ of G by

$$d_l(\cdot g) = \Delta(g^{-1}) d_l(\cdot).$$

Lemma 6.14. For any regular Borel measure μ on G , any g_0 in G , and any p with $1 \leq p < \infty$, the limit relations

$$\lim_{g \rightarrow g_0} \int_G |f(gx) - f(g_0x)|^p d\mu(x) = 0$$

and
$$\lim_{g \rightarrow g_0} \int_G |f(xg) - f(xg_0)|^p d\mu(x) = 0$$

⁶Propositions 11.19 and 11.18 of *Basic*.

hold for each f in $C_{\text{com}}(G)$. In particular,

$$g \mapsto \int_G f(gx) d\mu(x) \quad \text{and} \quad g \mapsto \int_G f(xg) d\mu(x)$$

are continuous scalar-valued functions for such f .

PROOF. Corollary 6.7 shows that $g \mapsto f(g(\cdot))$ is continuous from G into $C(G)$. Let $\epsilon > 0$ be given, and choose a neighborhood N of g_0 such that $\sup_{x \in G} |f(gx) - f(g_0x)| \leq \epsilon$ for g in N . If K is a compact neighborhood of g_0 , then the set of products $K \text{ support}(f)$ is compact, being the continuous image of a compact subset of $G \times G$ under multiplication. It therefore has finite μ measure, say C . When g is in $K \cap N$, we have

$$\int_G |f(gx) - f(g_0x)|^p d\mu(x) \leq \epsilon^p \mu(K \text{ support}(f)) = C\epsilon^p,$$

and the first limit relation follows. Taking $p = 1$, we have

$$\left| \int_G f(gx) d\mu(x) - \int_G f(g_0x) d\mu(x) \right| \leq \int_G |f(gx) - f(g_0x)| d\mu(x),$$

and we have just seen that the right side tends to 0 as g tends to g_0 . This proves the first conclusion about continuity of scalar-valued functions.

For the other limit relation and continuity result, we replace f by the function \tilde{f} with $\tilde{f}(x) = f(x^{-1})$, and we apply to \tilde{f} what has just been proved, taking into account the continuity of the inversion mapping on G . \square

Proposition 6.15. The modular function Δ for G has the properties that

- (a) $\Delta : G \rightarrow \mathbb{R}^+$ is a continuous group homomorphism,
- (b) $\Delta(g) = 1$ for g in any compact subgroup of G ,
- (c) $d_l(x^{-1})$ and $\Delta(x) d_l x$ are right Haar measures and are equal,
- (d) $d_r(x^{-1})$ and $\Delta(x)^{-1} d_r x$ are left Haar measures and are equal,
- (e) $d_r(g \cdot) = \Delta(g) d_r(\cdot)$ for any right Haar measure on G .

PROOF. For (a), we take $d\mu(x) = d_l x$ in Lemma 6.14 and see that the function $g \mapsto \int_G f(xg) d_l x = \int_G f(x) d_l(xg^{-1}) = \Delta(g) \int_G f(x) d_l x$ is continuous if f is in $C_{\text{com}}(G)$. Since there exist functions f in $C_{\text{com}}(G)$ with $\int_G f(x) d_l x \neq 0$, $g \mapsto \Delta(g)$ is continuous. The homomorphism property follows from the fact that $\Delta(hg) d_l x = d_l(x(hg)^{-1}) = d_l((xg^{-1})h^{-1}) = \Delta(h) d_l(xg^{-1}) = \Delta(h)\Delta(g) d_l x$.

For (b), the image under Δ of any compact subgroup of G is a compact subgroup of \mathbb{R}^+ and hence is $\{1\}$.

In (c), put $d\mu(x) = \Delta(x) d_l x$. This is a regular Borel measure since Δ is continuous by (a). Since Δ is a homomorphism, we have

$$\begin{aligned} \int_G f(xg) d\mu(x) &= \int_G f(xg) \Delta(x) d_l x = \int_G f(x) \Delta(xg^{-1}) d_l(xg^{-1}) \\ &= \int_G f(x) \Delta(x) \Delta(g^{-1}) \Delta(g) d_l x \\ &= \int_G f(x) \Delta(x) d_l x = \int_G f(x) d\mu(x). \end{aligned}$$

Hence $d\mu(x)$ is a right Haar measure. Meanwhile, $d_l(x^{-1})$ is a right Haar measure because

$$\begin{aligned} \int_G f(xg) d_l(x^{-1}) &= \int_G f(x^{-1}g) d_lx = \int_G f((g^{-1}x)^{-1}) d_lx \\ &= \int_G f(x^{-1}) d_lx = \int_G f(x) d_l(x^{-1}). \end{aligned}$$

Thus Theorem 6.8 for right Haar measures implies that $d_l(x^{-1}) = c\Delta(x) d_lx$ for some constant $c > 0$. Changing x to x^{-1} in this formula, we obtain

$$d_lx = c\Delta(x^{-1}) d_l(x^{-1}) = c^2\Delta(x^{-1})\Delta(x) d_lx = c^2 d_lx.$$

Hence $c = 1$, and (c) is proved.

For (d) and (e) there is no loss of generality in assuming that $d_r x = d_l(x^{-1}) = \Delta(x) d_lx$, in view of (c). Conclusion (d) is immediate from this identity if we replace x by x^{-1} . For (e) we have

$$\begin{aligned} \int_G f(x) d_r(gx) &= \int_G f(g^{-1}x) d_r x = \int_G f(g^{-1}x)\Delta(x) d_lx = \int_G f(x)\Delta(gx) d_lx \\ &= \Delta(g) \int_G f(x)\Delta(x) d_lx = \Delta(g) \int_G f(x) d_r x, \end{aligned}$$

and we conclude that $d_r(g \cdot) = \Delta(g) d_r(\cdot)$. \square

The locally compact group G is said to be **unimodular** if every left Haar measure is a right Haar measure (and vice versa). In this case we can speak of **Haar measure** on G .

In view of Proposition 6.15e, G is unimodular if and only if $\Delta(t) = 1$ for all $t \in G$. Locally compact abelian groups are of course unimodular. Proposition 6.15b shows that compact groups are unimodular.

Any commutator $ghg^{-1}h^{-1}$ in G is carried to 1 by the modular function Δ . Consequently any group that is generated by commutators, such as $SL(N, \mathbb{R})$, is unimodular. More generally any group that is generated by commutators, elements of the center, and elements of finite order is unimodular; $GL(N, \mathbb{R})$ is an example.

Theorem 6.16. Let G be a separable locally compact group, and let S and T be closed subgroups such that $S \cap T$ is compact, multiplication $S \times T \rightarrow G$ is an open map, and the set of products ST exhausts G except possibly for a set of Haar measure 0. Let Δ_T and Δ_G denote the modular functions of T and G . Then the left Haar measures on G , S , and T can be normalized so that

$$\int_G f(x) d_lx = \int_{S \times T} f(st) \frac{\Delta_T(t)}{\Delta_G(t)} d_l s d_l t$$

for all Borel functions $f \geq 0$ on G .

REMARK. The assumption of separability avoids all potential problems with using Fubini's Theorem in the course of the proof. Problems 21–22 at the end of the chapter give a condition under which multiplication $S \times T \rightarrow G$ is an open map, and they provide examples.

PROOF. Let $\Omega \subseteq G$ be the set of products ST , and let $K = S \cap T$. The group $S \times T$ acts continuously on Ω by $(s, t)\omega = s\omega t^{-1}$, and the isotropy subgroup at 1 is $\text{diag } K$. Thus the map $(s, t) \mapsto st^{-1}$ descends to a map $(S \times T)/\text{diag } K \rightarrow \Omega$. This map is a homeomorphism since multiplication $S \times T \rightarrow G$ is assumed to be an open map.

Hence any Borel measure on Ω can be reinterpreted as a Borel measure on $(S \times T)/\text{diag } K$. We apply this observation to the restriction of a left Haar measure $d_l x$ for G from G to Ω , obtaining a Borel measure $d\mu$ on $(S \times T)/\text{diag } K$. On Ω , we have

$$d_l(s_0 x t_0^{-1}) = \Delta_G(t_0) d_l x,$$

and the action unwinds to

$$d\mu((s_0, t_0)(s, t)(\text{diag } K)) = \Delta_G(t_0) d\mu((s, t)(\text{diag } K)) \quad (*)$$

on $(S \times T)/\text{diag } K$. Using the Riesz Representation Theorem, define a measure $d\tilde{\mu}(s, t)$ on $S \times T$ in terms of a positive linear functional on $C_{\text{com}}(S \times T)$ by

$$\int_{S \times T} f(s, t) d\tilde{\mu}(s, t) = \int_{(S \times T)/\text{diag } K} \left[\int_K f(sk, tk) dk \right] d\mu((s, t)(\text{diag } K)),$$

where dk is a Haar measure on K normalized to have total mass 1. From (*) it follows that

$$d\tilde{\mu}(s_0 s, t_0 t) = \Delta_G(t_0) d\tilde{\mu}(s, t).$$

The same proof as for the uniqueness in Theorem 6.8 shows that any two Borel measures on $S \times T$ with this property are proportional, and $\Delta_G(t) d_l s d_l t$ is such a measure. Therefore

$$d\tilde{\mu}(s, t) = \Delta_G(t) d_l s d_l t$$

for a suitable normalization of $d_l s d_l t$.

The resulting formula is

$$\int_{\Omega} f(x) d_l x = \int_{S \times T} f(st^{-1}) \Delta_G(t) d_l s d_l t$$

for all Borel functions $f \geq 0$ on Ω . On the right side the change of variables $t \mapsto t^{-1}$ makes the right side become

$$\int_{S \times T} f(st) \Delta_G(t)^{-1} d_l s \Delta_T(t) d_l t,$$

according to Proposition 6.15c, and we can replace Ω by G on the left side since the complement of Ω in G has measure 0 by assumption. This completes the proof. \square

4. Invariant Measures on Quotient Spaces

If H is a closed subgroup of G , then we can ask whether G/H has a nonzero G invariant Borel measure. Theorem 6.18 below will give a necessary and sufficient condition for this existence, but we need some preparation. Fix a left Haar measure d_lh for H . If f is in $C_{\text{com}}(G)$, define

$$f^\#(g) = \int_H f(gh) d_lh.$$

This function is invariant under right translation by H , and we can define

$$f^{\#\#}(gH) = f^\#(g).$$

The function $f^{\#\#}$ has compact support on G/H .

Lemma 6.17. The map $f \mapsto f^{\#\#}$ carries $C_{\text{com}}(G)$ onto $C_{\text{com}}(G/H)$, and a nonnegative member of $C_{\text{com}}(G/H)$ has a nonnegative preimage in $C_{\text{com}}(G)$.

PROOF. Let $\pi : G \rightarrow G/H$ be the quotient map. Let $F \in C_{\text{com}}(G/H)$ be given, and let K be a compact set in G/H with $F = 0$ off K . We first produce a compact set \tilde{K} in G with $\pi(\tilde{K}) = K$. For each coset in K , select an inverse image x and let N_x be a compact neighborhood of x in G . Since π is open, π of the interior of N_x is open. These open sets cover K , and a finite number of them suffices. Then we can take \tilde{K} to be the intersection of the closed set $\pi^{-1}(K)$ with the compact union of the finitely many N_x 's.

Next let K_H be a compact neighborhood of 1 in H . Since nonempty open sets always have positive Haar measure, the left Haar measure on H is positive on K_H . Let \tilde{K}' be the compact set $\tilde{K}' = \tilde{K}K_H$, so that $\pi(\tilde{K}') = \pi(\tilde{K}) = K$. Choose $f_1 \in C_{\text{com}}(G)$ with $f_1 \geq 0$ everywhere and with $f_1 = 1$ on \tilde{K}' . If g is in \tilde{K}' , then $\int_H f_1(gh) d_lh$ is \geq the H measure of K_H , and hence $f_1^{\#\#}$ is > 0 on K . Define

$$f(g) = \begin{cases} f_1(g) \frac{F(\pi(g))}{f_1^{\#\#}(\pi(g))} & \text{if } \pi(g) \in K, \\ 0 & \text{otherwise.} \end{cases}$$

Then $f^{\#\#}$ equals F on K and equals 0 off K , and therefore $f^{\#\#} = F$ everywhere.

Certainly f has compact support. To see that f is continuous, it suffices to check that the two formulas for $f(g)$ fit together continuously at points g of the

closed set $\pi^{-1}(K)$. It is enough to check points where $f(g) \neq 0$. Say $g_\alpha \rightarrow g$ for a net $\{g_\alpha\}$. We must have $F(\pi(g)) \neq 0$. Since F is continuous, $F(\pi(g_\alpha)) \neq 0$ eventually. Thus for all α sufficiently large, $f(g_\alpha)$ is given by the first of the two formulas. Thus f is continuous. \square

Theorem 6.18. Let G be a locally compact group, let H be a closed subgroup, and let Δ_G and Δ_H be the respective modular functions. Then a necessary and sufficient condition for G/H to have a nonzero G invariant regular Borel measure is that the restriction to H of Δ_G equal Δ_H . In this case such a measure $d\mu(gH)$ is unique up to a scalar, and it can be normalized so that

$$\int_G f(g) d_l g = \int_{G/H} \left[\int_H f(gh) d_l h \right] d\mu(gH)$$

for all $f \in C_{\text{com}}(G)$.

PROOF. Let $d\mu(gH)$ be a nonzero invariant regular Borel measure on G/H . Using the function $f^{\#\#}$ defined above, we can define a measure $d\tilde{\mu}(g)$ on G via a linear functional on $C_{\text{com}}(G)$ by

$$\int_G f(g) d\tilde{\mu}(g) = \int_{G/H} f^{\#\#}(gH) d\mu(gH).$$

Since $f \mapsto f^{\#\#}$ commutes with left translation by G , $d\tilde{\mu}$ is a left Haar measure on G . By Theorem 6.8, $d\tilde{\mu}$ is unique up to a scalar; hence $d\mu(gH)$ is unique up to a scalar.

Under the assumption that G/H has a nonzero invariant Borel measure, we have just seen in essence that we can normalize the measure so that the boxed formula holds. If we replace f in the boxed formula by $f(\cdot h_0)$, then the left side is multiplied by $\Delta_G(h_0)$, and the right side is multiplied by $\Delta_H(h_0)$. Hence $\Delta_G|_H = \Delta_H$ is necessary for existence.

Let us prove that this condition is sufficient for existence. If h in $C_{\text{com}}(G/H)$ is given, we can choose f in $C_{\text{com}}(G)$ by Lemma 6.17 such that $f^{\#\#} = h$. Then we define $L(h) = \int_G f(g) d_l g$. If L is well defined, then it is a linear functional, Lemma 6.17 shows that it is positive, and L certainly is the same on a function as on its G translates. By the Riesz Representation Theorem, L defines a G invariant Borel measure $d\mu(gH)$ on G/H such that the boxed formula holds.

Thus all we need to do is see that L is well defined if $\Delta_G|_H = \Delta_H$. We are thus to prove that if $f \in C_{\text{com}}(G)$ has $f^{\#\#} = 0$, then $\int_G f(g) d_l g = 0$. Let ψ be in $C_{\text{com}}(G)$. Since Fubini's Theorem is applicable to continuous functions of compact support, we have

$$\begin{aligned} 0 &= \int_G \psi(g) f^{\#\#}(g) d_l g \\ &= \int_G \left[\int_H \psi(g) f(gh) d_l h \right] d_l g \end{aligned}$$

$$\begin{aligned}
&= \int_H \left[\int_G \psi(g) f(gh) d_l g \right] d_l h \\
&= \int_H \left[\int_G \psi(gh^{-1}) f(g) d_l g \right] \Delta_G(h) d_l h && \text{by definition of } \Delta_G \\
&= \int_G f(g) \left[\int_H \psi(gh^{-1}) \Delta_G(h) d_l h \right] d_l g \\
&= \int_G f(g) \left[\int_H \psi(gh) \Delta_G(h)^{-1} \Delta_H(h) d_l h \right] d_l g && \text{by Proposition 6.15c} \\
&= \int_G f(g) \psi^\#(g) d_l g && \text{since } \Delta_G|_H = \Delta_H.
\end{aligned}$$

By Lemma 6.17 we can choose $\psi \in C_{\text{com}}(G)$ such that $\psi^{\#\#} = 1$ on the image in G/H of the support of f . Then the right side of the above display is $\int_G f(g) d_l g$, and the conclusion is that this is 0. Thus L is well defined, and existence is proved. \square

EXAMPLE. Let $G = SL(2, \mathbb{R})$, and let \mathcal{H} be the upper half plane in \mathbb{C} , namely $\{z \mid \text{Im } z > 0\}$. The group G acts continuously on \mathcal{H} by linear fractional transformations, the action being

$$\begin{pmatrix} a & b \\ c & d \end{pmatrix} (z) = \frac{az + b}{cz + d}.$$

This action is transitive since

$$\begin{pmatrix} y^{1/2} & xy^{-1/2} \\ 0 & y^{-1/2} \end{pmatrix} (i) = x + iy \quad \text{if } y > 0, \quad (*)$$

and the subgroup that leaves i fixed, by direct computation, is the rotation subgroup K , which consists of the matrices $\begin{pmatrix} \cos \theta & -\sin \theta \\ \sin \theta & \cos \theta \end{pmatrix}$. The mapping of G to \mathcal{H} given by $g \mapsto g(i)$ therefore descends to a one-one continuous map of G/K onto \mathcal{H} , and Problem 3 at the end of the chapter shows that this map is a homeomorphism. The group G is generated by commutators and hence is unimodular, and the subgroup K is unimodular, being compact. Theorem 6.18 therefore says that \mathcal{H} has a G -invariant Borel measure that is unique up to a scalar factor. Let us see for $p = -2$ that the measure $y^p dx dy$ is invariant under the subgroup acting in (*). We have

$$\begin{pmatrix} y_0^{1/2} & x_0 y_0^{-1/2} \\ 0 & y_0^{-1/2} \end{pmatrix} (x + iy) = y_0(x + iy) + x_0 = (y_0 x + x_0) + iy_0 y. \quad (**)$$

If φ denotes left translation by the matrix on the left in (**), then $(dx dy)_{\varphi^{-1}} = y_0^2 dx dy$. Hence $(y^{-2} dx dy)_{\varphi^{-1}} = (y^{-2})^\varphi (dx dy)_{\varphi^{-1}} = (y_0^{-2} y^{-2}) (y_0^2 dx dy) = y^{-2} dx dy$, and $y^{-2} dx dy$ is preserved by every matrix in (**). The group G is generated by the matrices in (**) and the one additional matrix $\begin{pmatrix} 0 & 1 \\ -1 & 0 \end{pmatrix}$. Since

$$\begin{pmatrix} 0 & 1 \\ -1 & 0 \end{pmatrix} (x + iy) = \frac{1}{(-1)(x + iy)} = \frac{-x + iy}{x^2 + y^2},$$

$\begin{pmatrix} 0 & 1 \\ -1 & 0 \end{pmatrix}$ sends $y^{-2} dx dy$ to $\left(\frac{y}{x^2+y^2}\right)^{-2} |\det J| dx dy$, where J is the Jacobian matrix of $F(x, y) = \left(\frac{-x}{x^2+y^2}, \frac{y}{x^2+y^2}\right)$, namely $J = \begin{pmatrix} \frac{x^2-y^2}{(x^2+y^2)^2} & \frac{2xy}{(x^2+y^2)^2} \\ \frac{-2xy}{(x^2+y^2)^2} & \frac{x^2-y^2}{(x^2+y^2)^2} \end{pmatrix}$. Calculation gives $|\det J| = (x^2 + y^2)^{-2}$, and therefore $\begin{pmatrix} 0 & 1 \\ -1 & 0 \end{pmatrix}$ sends $y^{-2} dx dy$ to itself. Consequently $y^{-2} dx dy$ is, up to a multiplicative constant, the one and only G -invariant measure on \mathcal{H} .

5. Convolution and L^p Spaces

We turn our attention to the way that Haar measure arises in real analysis. This section will introduce convolution, and aspects of Fourier analysis in the setting of various kinds of locally compact groups will be touched upon in later sections and in the problems at the end of that chapter. In most such applications of Haar measure to Fourier analysis, one assumes that the group under study is unimodular, even if some of its closed subgroups are not.

Thus let G be a locally compact group. We assume throughout this section that G is unimodular. We can then write dx for a two-sided Haar measure on G . Proposition 6.15c shows that we have $\int_G f(x^{-1}) dx = \int_G f(x) dx$ for all Borel functions $f \geq 0$. We abbreviate $L^p(G, dx)$ as $L^p(G)$.

Proposition 6.19. Let G be unimodular, let $1 \leq p < \infty$, and let f be a Borel function in L^p . Then $g \mapsto gf$ and $g \mapsto fg$ are continuous functions from G into L^p .

PROOF. Lemma 6.14 gives the result for f in $C_{\text{com}}(G)$. Proposition 11.21 of *Basic* shows that $C_{\text{com}}(G)$ is dense in $L^p(G)$. Given $g_0 \in G$ and $\epsilon > 0$, find h in $C_{\text{com}}(G)$ with $\|f - h\|_p \leq \epsilon$. Then

$$\begin{aligned} \|gf - g_0f\|_p &\leq \|gf - gh\|_p + \|gh - g_0h\|_p + \|g_0h - g_0f\|_p \\ &= 2\|f - h\|_p + \|gh - g_0h\|_p \quad \text{by left invariance of } dx \\ &\leq 2\epsilon + \|gh - g_0h\|_p, \end{aligned}$$

and hence $\limsup_{g \rightarrow g_0} \|gf - g_0f\|_p \leq 2\epsilon$. Since ϵ is arbitrary, we see that gf tends to g_0f in $L^p(G)$ as g tends to g_0 . Similarly fg tends to fg_0 in $L^p(G)$ as g tends to g_0 . \square

A key tool for real analysis on G is convolution, just as it was with \mathbb{R}^N . On a formal level the **convolution** $f * h$ of two functions f and h is

$$(f * h)(x) = \int_G f(xy^{-1})h(y) dy = \int_G f(y)h(y^{-1}x) dy.$$

The formal equality of the two integrals comes about by changing y into y^{-1} in the first integral and then replacing xy by y . If G is abelian, then $xy^{-1} = y^{-1}x$; thus the first integral for $f * h$ equals the second integral for $h * f$, and the conclusion is that convolution is commutative. However, convolution is not commutative if G is nonabelian.

To make mathematical sense out of $f * h$, we adapt the corresponding known discussion⁷ for the special case $G = \mathbb{R}^N$. Let us begin with the case that f and h are nonnegative Borel functions on G . The question is whether $f * h$ is meaningful as a Borel function ≥ 0 . In fact, $(x, y) \mapsto f(xy^{-1})$ is the composition of the continuous function $F : G \times G \rightarrow G$ given by $F(x, y) = xy^{-1}$, followed by the Borel function $f : G \rightarrow [0, +\infty]$. If U is open in $[0, +\infty]$, then $f^{-1}(U)$ is in $\mathcal{B}(G)$, and an argument like the one for Proposition 6.8 shows that $(f \circ F)^{-1}(U) = F^{-1}(f^{-1}(U))$ is in $\mathcal{B}(G \times G)$. Then the product $(x, y) \mapsto f(xy^{-1})g(y)$ is a Borel function, and we would like to use Fubini's Theorem to conclude that $x \mapsto (f * h)(x)$ is a Borel function ≥ 0 . Unfortunately we do not know whether the σ -algebras match properly, specifically whether $\mathcal{B}(G \times G) = \mathcal{B}(G) \times \mathcal{B}(G)$.

On the other hand, this kind of product relation does hold for Baire sets. We therefore repeat the above argument with nonnegative Baire functions in place of nonnegative Borel functions. Now the only possible difficulty comes from the fact that Haar measure on G might not be σ -finite. This problem is easily handled by the same kind of localization argument as with the proof of uniqueness for Theorem 6.8: Suppose that G is not σ -compact and that $f \geq 0$ is a Baire function on G . If E is any subset of $[0, +\infty]$, then $f^{-1}(E)$ and $f^{-1}(E^c)$ are disjoint Baire sets. Since any two Baire sets that fail to be σ -bounded have nonempty intersection, only one of $f^{-1}(E)$ and $f^{-1}(E^c)$ can fail to be σ -bounded. It follows that there is exactly one member c of $[0, +\infty]$ for which $f^{-1}(c)$ is not σ -bounded. So as to avoid unimportant technicalities, let us assume for all Baire functions under discussion that this value is 0, i.e., that each Baire function considered in some convolution vanishes off some σ -bounded set. Any σ -bounded set is contained in some σ -compact open subgroup G_0 of G , and thus the convolution effectively takes place on the σ -compact open subgroup G_0 ; the convolution is 0 outside G_0 .

Proposition 6.20. Suppose that f and h are nonnegative Baire functions on G , each vanishing off a σ -bounded subset of G . Let $1 \leq p \leq \infty$, and let p' be the dual index. Then convolution is finite almost everywhere in the following cases, and then the indicated inequalities of norms are satisfied:

- (a) for f in $L^1(G)$ and h in $L^p(G)$, and then $\|f * h\|_p \leq \|f\|_1 \|h\|_p$,
- for f in $L^p(G)$ and h in $L^1(G)$, and then $\|f * h\|_p \leq \|f\|_p \|h\|_1$,

⁷The discussion in question appears in Section VI.2 of *Basic*.

- (b) for f in $L^p(G)$ and h in $L^{p'}(G)$, and then $\|f * h\|_{\text{sup}} \leq \|f\|_p \|h\|_{p'}$,
 for f in $L^{p'}(G)$ and h in $L^p(G)$, and then $\|f * h\|_{\text{sup}} \leq \|f\|_{p'} \|h\|_p$.

Consequently $f * h$ is defined in the above situations even if the scalar-valued functions f and h are not necessarily ≥ 0 , and the estimates on the norm of $f * h$ are still valid. In case (b), the function $f * h$ is actually continuous.

REMARK. The proof of the continuity in (b) will show actually that $f * h$ is uniformly continuous in a certain sense.

PROOF. The argument for measurability has been given above. The argument for the norm inequalities is proved in the same way⁸ as in the special case that $G = \mathbb{R}^N$. Namely, we use Minkowski's inequality for integrals to handle (a), and we use Hölder's inequality to handle (b).

Now consider the question of continuity in (b). At least one of the indices p and p' is finite. First suppose that p is finite. We observe for $g \in G$ that $g(f * h)(x) = (f * h)(g^{-1}x) = \int_G f(g^{-1}xy^{-1})h(y) dy = \int_G (gf)(xy^{-1})h(y) dy = (gf) * h(x)$. Then we use the bound $\|f * h\|_{\text{sup}} \leq \|f\|_p \|h\|_{p'}$ to make the estimate, for $g \in G$, that

$$\begin{aligned} \|g(f * h) - (f * h)\|_{\text{sup}} &= \|(gf) * h - f * h\|_{\text{sup}} \\ &= \|(gf - f) * h\|_{\text{sup}} \leq \|gf - f\|_p \|h\|_{p'}. \end{aligned}$$

Proposition 6.19 shows that the right side tends to 0 as g tends to 1, and hence $\lim_{g \rightarrow 1} (f * h)(g^{-1}x) = (f * h)x$. If instead p' is finite, we argue similarly with right translations of h , finding first that $(f * h)g = f * (hg)$ and then that $\|(f * h)g - (f * h)\|_{\text{sup}} \leq \|f\|_p \|hg - h\|_{p'}$. Application of Proposition 6.19 therefore shows that $\lim_{g \rightarrow 1} (f * h)(xg^{-1}) = (f * h)(x)$. \square

Corollary 6.21. Convolution makes $L^1(G)$ into an associative algebra (possibly without identity) in such a way that the norm satisfies $\|f * h\|_1 \leq \|f\|_1 \|h\|_1$ for all f and h in $L^1(G)$.

PROOF. The norm inequality was proved in Proposition 6.20a, and it justifies the interchange of integrals in the calculation

$$\begin{aligned} ((f_1 * f_2) * f_3)(x) &= \int_G \int_G f_1(y) f_2(y^{-1}z) f_3(z^{-1}x) dy dz \\ &= \int_G \int_G f_1(y) f_2(y^{-1}z) f_3(z^{-1}x) dz dy \\ &= \int_G \int_G f_1(y) f_2(z) f_3(z^{-1}y^{-1}x) dz dy \quad \text{under } z \mapsto yz \\ &= (f_1 * (f_2 * f_3))(x), \end{aligned}$$

which in turn proves associativity. \square

⁸Propositions 6.14 and 9.10 of *Basic*.

We shall need the following result in proving the Peter–Weyl Theorem in Section 7.

Proposition 6.22. Let G be a compact group, let f be in $L^1(G)$, and let h be in $L^2(G)$. Put $F(x) = \int_G f(y)h(y^{-1}x) dy$. Then F is the limit in $L^2(G)$ of a sequence of functions, each of which is a finite linear combination of left translates of h .

REMARK. For a comparable result in \mathbb{R}^N , see Corollary 6.17 of *Basic*. We know from Proposition 6.15b that compact groups are unimodular.

For the proof we require a lemma.

Lemma 6.23. Let G be a compact group, and let h be in $L^2(G)$. For any $\epsilon > 0$, there exist finitely many $y_i \in G$ and Borel sets $E_i \subseteq G$ such that the E_i disjointly cover G and

$$\|h(y^{-1}x) - h(y_i^{-1}x)\|_{2,x} < \epsilon \quad \text{for all } i \text{ and for all } y \in E_i.$$

PROOF. By Proposition 6.19 choose an open neighborhood U of 1 such that $\|h(gx) - h(x)\|_{2,x} < \epsilon$ whenever g is in U . For each $z_0 \in G$, we have $\|h(gz_0x) - h(z_0x)\|_{2,x} < \epsilon$ whenever g is in U . The set Uz_0 is an open neighborhood of z_0 , and such sets cover G as z_0 varies. Find a finite subcover, say Uz_1, \dots, Uz_n , and let $U_i = Uz_i$. Define $F_j = U_j - \bigcup_{i=1}^{j-1} U_i$ for $1 \leq j \leq n$. Then the lemma follows with $y_i = z_i^{-1}$ and $E_i = F_i^{-1}$. \square

PROOF OF PROPOSITION 6.22. Given $\epsilon > 0$, choose y_i and E_i as in Lemma 6.23, and put $c_i = \int_{E_i} f(y) dy$. Then

$$\begin{aligned} \left\| \int_G f(y)h(y^{-1}x) dy - \sum_i c_i h(y_i^{-1}x) \right\|_{2,x} \\ \leq \left\| \sum_i \int_{E_i} |f(y)| |h(y^{-1}x) - h(y_i^{-1}x)| dy \right\|_{2,x} \\ \leq \sum_i \int_{E_i} |f(y)| \|h(y^{-1}x) - h(y_i^{-1}x)\|_{2,x} dy \\ \leq \sum_i \int_{E_i} |f(y)| \epsilon dy = \epsilon \|f\|_1. \end{aligned} \quad \square$$

6. Representations of Compact Groups

The subject of functional analysis always suggests trying to replace a mathematical problem about functions by a problem about a space of functions and working at solving the latter. By way of example, this point of view is what lay behind our approach in Section I.2 to certain kinds of boundary-value problems

by using the method of separation of variables. In some of the cases of separation of variables we considered, as well as in other situations arising in nature, the problem has some symmetry to it, and that symmetry gets passed along to the space of functions under study. Mathematically the symmetry is captured by a group, since the set of symmetries is associative and is closed under composition and inversion. The subject of representation theory deals with exploiting such symmetry, at least in cases for which the problem about functions is linear.

We shall begin with a definition and some examples of finite-dimensional representations of an arbitrary topological group, and then we shall develop a certain amount of theory of finite-dimensional representations under the assumption that the group is compact. The main theorem in this situation is the Peter–Weyl Theorem, which we take up in the next section. In Section 8 we introduce infinite-dimensional representations because vector spaces of functions that arise in analysis problems are frequently infinite-dimensional; in that section we study what happens when the group is compact, but a considerable body of mathematics beyond the scope of this book investigates what can happen for a noncompact group.

Historically the original representations that were studied were matrix representations. An N -by- N **matrix representation** of a topological group G is a continuous homomorphism Φ of G into the group $GL(N, \mathbb{C})$ of invertible complex matrices. In other words, $\Phi(g)$ is an N -by- N invertible complex matrix for each g in G , the matrices are related by the condition that $\Phi(gh)_{ij} = \sum_{k=1}^N \Phi(g)_{ik} \Phi(h)_{kj}$, and the functions $g \mapsto \Phi(g)_{ij}$ are continuous.

Eventually it was realized that sticking to matrices obscures what is really happening. For one thing the group $GL(N, \mathbb{C})$ is being applied to the space \mathbb{C}^N of column vectors, and some vector subspaces of \mathbb{C}^N seem more important than others when they are really not. Instead, it is better to replace \mathbb{C}^N by a finite-dimensional complex vector space V and consider continuous homomorphisms of G into the group $GL_{\mathbb{C}}(V)$ of invertible linear transformations on V . Specifying an ordered basis of V allows one to identify $GL_{\mathbb{C}}(V)$ with $GL(N, \mathbb{C})$, and then the homomorphism gets identified with a matrix representation. In the special case that $V = \mathbb{C}^N$, this identification can be taken to be the usual identification of linear functions and matrices. The point, however, is that it is unwise to emphasize one particular ordered basis in advance, and it is better to work with a general finite-dimensional complex vector space.

Thus we define a **finite-dimensional representation** of a topological group G on a finite-dimensional complex vector space V to be a continuous homomorphism Φ of G into $GL_{\mathbb{C}}(V)$. The continuity condition means that in any basis of V the matrix entries of $\Phi(g)$ are continuous for $g \in G$. It is equivalent to say that $g \mapsto \Phi(g)v$ is a continuous function from G into V for each v in V , i.e., that for each v in V , if $\Phi(g)v$ is expanded in terms of a basis of V , then each

entry is a continuous function of g . The vector space V is allowed to be \mathbb{C}^N in the definition, and thus matrix representations are part of the theory.

Before coming to a list examples, let us dispose of two easy kinds of examples that immediately suggest themselves.

For any G the **trivial representation** of G on V is the representation Φ of G for which $\Phi(g) = 1$ for all $g \in G$. Sometimes when the term “trivial representation” is used, it is understood that $V = \mathbb{C}$; sometimes the case $V = \mathbb{C}$ is indicated by referring to the “trivial 1-dimensional representation.”

If G is a group of real or complex invertible N -by- N matrices, then G is a subgroup of $GL(N, \mathbb{C})$, and the relative topology from $GL(N, \mathbb{C})$ makes G into a topological group. The inclusion mapping Φ of G into $GL(N, \mathbb{C})$ is a representation known as the **standard representation** of G . The following question then arises: If G is such a group, why consider representations of G when we already have one? The answer, from an analyst’s point of view, is that representations are thrust on us by some mathematical problem that we want to solve, and we have to work with what we are given; other representations than the standard one may occur in the process.

EXAMPLES OF FINITE-DIMENSIONAL REPRESENTATIONS.

(1) One-dimensional representations. A continuous homomorphism of a topological group G into the multiplicative group \mathbb{C}^\times of nonzero complex numbers is a representation because we can regard \mathbb{C}^\times as $GL(1, \mathbb{C})$. Of special interest are the representations of this kind that take values in the unit circle $\{e^{i\theta}\}$. These are called **multiplicative characters**.

(a) The exponential functions that arise in Fourier series are examples; the group G in this case is the circle group S^1 , namely the quotient of \mathbb{R} modulo the subgroup $2\pi\mathbb{Z}$ of multiples of 2π , and for each integer n , the function $x \mapsto e^{inx}$ is a multiplicative character of \mathbb{R} that descends to a well-defined multiplicative character of S^1 .

(b) The exponential functions that arise in the definition of the Fourier transform on \mathbb{R}^N , namely $x \mapsto e^{ix \cdot y}$, are multiplicative characters of the additive group \mathbb{R}^N .

(c) Let J_m be the cyclic group $\{0, 1, 2, \dots, m-1\}$ of integers modulo m under addition, and let $\zeta_m = e^{2\pi i/m}$. For each integer n and for k in J_m , the formula $\chi_n(k) = (\zeta_m^n)^k$ defines a multiplicative character χ_n of J_m . These multiplicative characters are distinct for $0 \leq n \leq m-1$.

(d) If G is the symmetric group \mathfrak{S}_n on n letters, then the sign mapping $\sigma \mapsto \text{sgn } \sigma$ is a multiplicative character.

(e) The integer powers of the determinant are multiplicative characters of the unitary group $U(N)$.

(2) Some representations of the symmetric group \mathfrak{S}_3 on three letters.

(a) The trivial character and the sign character defined in Example 1d above are the only multiplicative characters.

(b) For each permutation σ , let $\Phi(\sigma)$ be the 3-by-3 matrix of the linear transformation carrying the standard ordered basis (e_1, e_2, e_3) of \mathbb{C}^3 to the ordered basis $(e_{\sigma(1)}, e_{\sigma(2)}, e_{\sigma(3)})$. To check that Φ is indeed a representation, we start from $\Phi(\sigma)e_j = e_{\sigma(j)}$; applying $\Phi(\tau)$ to both sides, we obtain $\Phi(\tau)\Phi(\sigma)e_j = \Phi(\tau)e_{\sigma(j)} = e_{\tau(\sigma(j))} = \Phi(\tau\sigma)e_j$, and we conclude that $\Phi(\tau)\Phi(\sigma) = \Phi(\tau\sigma)$. The vector $e_1 + e_2 + e_3$ is fixed by each $\Phi(\sigma)$, and therefore the 1-dimensional vector subspace $\mathbb{C}(e_1 + e_2 + e_3)$ is “invariant” in the sense of being carried to itself under $\Phi(\mathfrak{S}_3)$.

(c) Place an equilateral triangle in the plane \mathbb{R}^2 with its center at the origin and with vertices given in polar coordinates by $(r, \theta) = (1, 0)$, $(1, 2\pi/3)$, and $(1, 4\pi/3)$. Let the vertices be numbered 1, 2, 3, and let $\Phi(\sigma)$ be the matrix of the linear transformation carrying vertex j to vertex $\sigma(j)$ for each j . Then Φ is given on the transpositions $(1\ 2)$ and $(2\ 3)$ by

$$\Phi((1\ 2)) = \begin{pmatrix} -1/2 & \sqrt{3}/2 \\ \sqrt{3}/2 & 1/2 \end{pmatrix} \quad \text{and} \quad \Phi((2\ 3)) = \begin{pmatrix} 1 & 0 \\ 0 & -1 \end{pmatrix}$$

and is given on any product of these two transpositions by the corresponding product of the above two matrices. The eigenspaces for $\Phi((2\ 3))$ are $\mathbb{C}e_1$ and $\mathbb{C}e_2$, and these subspaces are not eigenspaces for $\Phi((1\ 2))$. Consequently the only vector subspaces carried to themselves by $\Phi(\mathfrak{S}_3)$ are the trivial ones, namely 0 and \mathbb{C}^2 . The functions on \mathfrak{S}_3 of the form $\sigma \mapsto \Phi(\sigma)_{ij}$ will play a role similar to the role of the functions $x \mapsto e^{inx}$ in Fourier series, and we record their values here:

σ	$\Phi(\sigma)_{11}$	$\Phi(\sigma)_{12}$	$\Phi(\sigma)_{21}$	$\Phi(\sigma)_{22}$
(1)	1	0	0	1
(123)	-1/2	$-\sqrt{3}/2$	$\sqrt{3}/2$	-1/2
(132)	-1/2	$\sqrt{3}/2$	$-\sqrt{3}/2$	-1/2
(12)	-1/2	$\sqrt{3}/2$	$\sqrt{3}/2$	1/2
(23)	1	0	0	-1
(13)	-1/2	$-\sqrt{3}/2$	$-\sqrt{3}/2$	1/2

(3) A family of representations of the unitary group $G = U(N)$. Let V consist of all polynomials in $z_1, \dots, z_N, \bar{z}_1, \dots, \bar{z}_N$ homogeneous of degree k , i.e., having every monomial of total degree k , and let

$$\Phi(g)P \left(\begin{pmatrix} z_1 \\ \vdots \\ z_N \end{pmatrix}, \begin{pmatrix} \bar{z}_1 \\ \vdots \\ \bar{z}_N \end{pmatrix} \right) = P \left(g^{-1} \begin{pmatrix} z_1 \\ \vdots \\ z_N \end{pmatrix}, \bar{g}^{-1} \begin{pmatrix} \bar{z}_1 \\ \vdots \\ \bar{z}_N \end{pmatrix} \right).$$

The vector subspace V' of **holomorphic polynomials** (those with no \bar{z} 's) is carried to itself by all $\Phi(g)$, and therefore V' is an **invariant subspace** in the sense of

being carried to itself by $\Phi(G)$. The restriction of the $\Phi(g)$'s to V' is thus itself a representation. When $k = 1$, this representation on V' may at first seem to be the standard representation of $U(N)$, but it is not. In fact, V' for $k = 1$ consists of all linear combinations of the N linear functionals

$$\begin{pmatrix} z_1 \\ \vdots \\ z_N \end{pmatrix} \mapsto z_1 \quad \text{through} \quad \begin{pmatrix} z_1 \\ \vdots \\ z_N \end{pmatrix} \mapsto z_N.$$

In other words, V' is actually the space of all linear functionals on \mathbb{C}^N . The definition of Φ by $\Phi(g)\ell(z) = \ell(g^{-1}z)$ for $z \in \mathbb{C}^N$ and for ℓ in the space of linear functionals involves no choice of basis. The representation on V' when $N = 1$ is the “contragredient” of the standard representation, in a sense that will be defined for any representation in Example 6 below.

(4) A family of representations of the special unitary group $G = SU(2)$ of all 2-by-2 unitary matrices of determinant 1, namely all matrices $\begin{pmatrix} \alpha & \beta \\ -\bar{\beta} & \bar{\alpha} \end{pmatrix}$ with $|\alpha|^2 + |\beta|^2 = 1$. Let V be the space of homogeneous holomorphic polynomials of degree n in z_1 and z_2 , let Φ be the representation defined in the same way as in Example 3, and let V' be the space of all holomorphic polynomials in z of degree n with

$$\Phi' \left(\begin{pmatrix} \alpha & \beta \\ -\bar{\beta} & \bar{\alpha} \end{pmatrix} \right) Q(z) = (\bar{\beta}z + \alpha)^n Q \left(\frac{\bar{\alpha}z - \beta}{\bar{\beta}z + \alpha} \right).$$

Define $E : V \rightarrow V'$ by $(EP)(z) = P \begin{pmatrix} z \\ 1 \end{pmatrix}$. Then E is an invertible linear mapping and satisfies $E\Phi(g) = \Phi'(g)E$ for all g , and we say that E exhibits Φ and Φ' as **equivalent** (i.e., isomorphic).

(5) A family of representations for G equal to the orthogonal group $O(N)$ or the rotation subgroup $SO(N)$. Let V consist of all polynomials in x_1, \dots, x_N homogeneous of degree k , and let

$$\Phi(g)P \left(\begin{pmatrix} x_1 \\ \vdots \\ x_N \end{pmatrix} \right) = P \left(g^{-1} \begin{pmatrix} x_1 \\ \vdots \\ x_N \end{pmatrix} \right).$$

Then Φ is a representation. When we want to emphasize the degree, let us write Φ_k and V_k . Define the Laplacian operator as usual by

$$\Delta = \frac{\partial^2}{\partial x_1^2} + \cdots + \frac{\partial^2}{\partial x_N^2}.$$

This carries V_k to V_{k-2} , and one checks easily that it satisfies $\Delta\Phi_k(g) = \Phi_{k-2}(g)\Delta$. This commutativity property implies that the kernel of Δ is an invariant subspace of V_k , the space of homogeneous **harmonic polynomials** of degree k .

(6) **Contragredient representation.** Let G be any topological group, and let Φ be a finite-dimensional representation of G on the complex vector space V . The **contragredient** of Φ is the representation Φ^c of G on the space of all linear functionals on V defined by $(\Phi^c(g)\ell)(v) = \ell(\Phi(g^{-1})v)$ for any linear functional ℓ and any v in V .

Having given a number of examples, let us return to a general topological group G . An important equivalent definition of finite-dimensional representation is that Φ is a continuous group action of G on a finite-dimensional complex vector space V by linear transformations. In this case the assertion about continuity is that the map $G \times V \rightarrow V$ is continuous jointly, rather than continuous only as a function of the first variable.

Let us deduce the joint continuity from continuity in the first variable. To do so, it is enough to verify continuity of $G \times V \rightarrow V$ at $g = 1$ and $v = 0$. Let $\dim_{\mathbb{C}} V = N$. The topology on V is obtained, as was spelled out above, by choosing an ordered basis and identifying V with \mathbb{C}^N . The resulting topology makes V into a topological vector space, and the topology does not depend on the choice of ordered basis; the independence of basis follows from the fact that every linear mapping on \mathbb{C}^N is continuous. Thus we fix an ordered basis (v_1, \dots, v_N) and regard the map $\{c_i\}_{i=1}^N \mapsto \sum_{i=1}^N c_i v_i$ as a homeomorphism of \mathbb{C}^N onto V . Put $\|\sum_{i=1}^N c_i v_i\| = (\sum_{i=1}^N |c_i|^2)^{1/2}$. Given $\epsilon > 0$, choose for each i between 1 and N a neighborhood U_i of 1 in G such that $\|\Phi(g)v_i - v_i\| < \epsilon$ for $g \in U_i$. If g is in $\bigcap_{i=1}^N U_i$ and if $v = \sum_i c_i v_i$ has $\|v\| < \epsilon$, then

$$\begin{aligned} \|\Phi(g)v\| &\leq \|\Phi(g)(\sum c_i v_i) - (\sum c_i v_i)\| + \|v\| \\ &\leq \sum |c_i| \|\Phi(g)v_i - v_i\| + \|v\| \\ &\leq (\sum |c_i|^2)^{1/2} N^{1/2} + \|v\| \quad \text{by the Schwarz inequality} \\ &\leq (N^{1/2} + 1)\epsilon. \end{aligned}$$

This proves the joint continuity at $(g, v) = (1, 0)$, and the joint continuity everywhere follows by translation in the two variables separately.

A representation on a *nonzero* finite-dimensional complex vector space V is **irreducible** if it has no invariant subspaces other than 0 and V . Every 1-dimensional representation is irreducible, and we observed that Example 2c is irreducible. We observed also that Examples 2b and 3 are not irreducible.

A representation Φ on the finite-dimensional complex vector space V is called **unitary** if an inner product, always assumed Hermitian, has been specified for V and if each $\Phi(g)$ is unitary relative to that inner product (i.e., has $\Phi(g)^* \Phi(g) = 1$ and hence $\Phi(g)^* = \Phi(g)^{-1}$ for all $g \in G$). On the level of the inner product for V , a unitary representation has the property that $(\Phi(g)u, v) = (u, \Phi(g)^* v) = (u, \Phi(g)^{-1} v) = (u, \Phi(g^{-1})v)$.

The question of whether a representation is unitary is important for analysis because it gets at the notion of exploiting symmetries by using representation theory. Specifically for a unitary representation the orthogonal complement U^\perp of an invariant vector subspace U is an invariant subspace because

$$(\Phi(g)u^\perp, u) = (u^\perp, \Phi(g^{-1})u) \in (u^\perp, U) = 0 \quad \text{for } u^\perp \in U^\perp, u \in U.$$

Thus when an analysis problem leads us to a unitary representation and we locate an invariant vector subspace, the orthogonal complement will be an invariant vector subspace also. In this way the analysis problem may have been subdivided into two simpler problems.

Now let us suppose that the topological group G is compact. One of the critical properties of such a group for representation theory is that G has, up to a scalar multiple, a unique two-sided Haar measure, i.e., a nonzero regular Borel measure that is invariant under all left and right translations. This result was proved in Theorem 6.8 and Proposition 6.15b. Let us normalize this Haar measure so that it has total measure 1. Since the normalized measure is unambiguous, we usually write integrals with respect to normalized Haar measure by expressions like $\int_G f(x) dx$, dropping any name like μ from the notation. Also, we write $L^1(G)$ and $L^2(G)$ in place of $L^1(G, dx)$ and $L^2(G, dx)$.

We shall want to use convolution of functions on G , and we therefore need to confront the technical problem that the measurability in Fubini's Theorem can break down with Borel measurable functions if G is not separable. For this reason we shall stick to Baire measurable functions, where no such difficulty occurs.⁹ In particular the spaces $L^1(G)$ and $L^2(G)$ will be understood to have the Baire sets as the relevant σ -algebras.¹⁰

The prototypes for the theory with G compact are the cases that G is the circle group S^1 and that G is a finite group, such as the symmetric group \mathfrak{S}_3 . The Haar measure is $\frac{1}{2\pi} dx$ in the first case, where this time we retain the convention that dx is Lebesgue measure. The Haar measure is $\frac{1}{6}$ times the counting measure in the second case, the $\frac{1}{6}$ having the effect of making the total measure be 1.

Proposition 6.24. If Φ is a representation of a compact group G on a finite-dimensional complex vector space V , then V admits an inner product such that Φ is unitary.

⁹Corollary 11.16 of *Basic* shows that every continuous function of compact support on a locally compact Hausdorff space is Baire measurable.

¹⁰Problem 3 at the end of Chapter XI of *Basic* shows for any regular Borel measure on a compact Hausdorff space that every Borel measurable function can be adjusted on a Borel set of measure 0 to be Baire measurable. Consequently the spaces $L^1(G)$ and $L^2(G)$ as Banach spaces are unaffected by specifying Baire measurability rather than Borel measurability if the Borel measure is regular.

PROOF. Let $\langle \cdot, \cdot \rangle$ be any Hermitian inner product on V , and define

$$(u, v) = \int_G \langle \Phi(x)u, \Phi(x)v \rangle dx.$$

It is straightforward to see that (\cdot, \cdot) has the required properties. \square

Corollary 6.25. If Φ is a representation of a compact group G on a finite-dimensional complex vector space V , then Φ is the direct sum of irreducible representations. In other words, $V = V_1 \oplus \cdots \oplus V_k$, with each V_j an invariant vector subspace on which Φ acts irreducibly.

REMARK. The “direct-sum” notation $V = V_1 \oplus \cdots \oplus V_k$ means that each element of V has a unique expansion as a linear combination of k vectors, one from each V_j . If G is the *noncompact* group of all complex matrices $\begin{pmatrix} a & b \\ 0 & 1 \end{pmatrix}$, then the standard representation of G on \mathbb{C}^2 has $\mathbb{C}e_1$ as an invariant subspace, but there is no other invariant subspace V' such that $\mathbb{C}^2 = \mathbb{C}e_1 \oplus V'$. Thus the corollary breaks down if the hypothesis of compactness is dropped completely.

PROOF. Form (\cdot, \cdot) as in Proposition 6.24. Find an invariant subspace $U \neq 0$ of minimal dimension and take its orthogonal complement U^\perp . Since the representation is unitary relative to (\cdot, \cdot) , U^\perp is an invariant subspace. Repeating the argument with U^\perp and iterating, we obtain the required decomposition. \square

Proposition 6.26 (Schur’s Lemma, part 1). Suppose that Φ and Φ' are irreducible representations of a compact group G on finite-dimensional complex vector spaces V and V' , respectively. If $L : V \rightarrow V'$ is a linear map such that $\Phi'(g)L = L\Phi(g)$ for all $g \in G$, then L is one-one onto or $L = 0$.

PROOF. We see easily that $\ker L$ and image L are invariant subspaces of V and V' , respectively, and then the only possibilities are the ones listed. \square

Corollary 6.27 (Schur’s Lemma, part 2). Suppose Φ is an irreducible representation of a compact group G on a finite-dimensional complex vector space V . If $L : V \rightarrow V$ is a linear map such that $\Phi(g)L = L\Phi(g)$ for all $g \in G$, then L is scalar.

REMARK. This is the first place where we make use of the fact that the scalars are complex, not real.

PROOF. Let λ be an eigenvalue of L . Then $L - \lambda I$ is not one-one onto, but it does commute with $\Phi(g)$ for all $g \in G$. By Proposition 6.26, $L - \lambda I = 0$. \square

Corollary 6.28. Every irreducible finite-dimensional representation of a compact abelian group G is given, up to equivalence, by a multiplicative character.

PROOF. If G is abelian and Φ is irreducible, we apply Corollary 6.27 with $L = \Phi(g_0)$ and see that $\Phi(g_0)$ is scalar. All the members of $\Phi(G)$ are therefore scalar, and every vector subspace is invariant. For irreducibility the representation must then be 1-dimensional. Fixing a basis $\{v\}$ of the 1-dimensional vector space and forming the corresponding 1-by-1 matrices, we obtain a multiplicative character. \square

EXAMPLE 1a, CONTINUED. For the circle group $S^1 = \mathbb{R}/2\pi\mathbb{Z}$, we observed that we obtain a family of multiplicative characters parametrized by the integers, the n^{th} such character being

$$x \mapsto e^{inx}.$$

The corresponding 1-dimensional representation is $x \mapsto$ multiplication by e^{inx} . In the next corollary we shall prove that the multiplicative characters are orthogonal in $L^2(S^1)$ in the same sense that the exponential functions are orthogonal. The known completeness of the orthonormal system of exponential functions therefore gives a proof, though not the simplest proof, that the exponential functions are the only multiplicative characters of S^1 . A simpler proof can be constructed via real-variable theory by making direct use of the multiplicative property and the continuity.

EXAMPLES 2a AND 2c, CONTINUED. We noted that the trivial character and the sign character are the only multiplicative characters of \mathfrak{S}_3 . These are the following two functions of $\sigma \in \mathfrak{S}_3$:

σ	$\Phi = 1$	$\Phi = \text{sign}$
(1)	1	1
(123)	1	1
(132)	1	1
(12)	1	-1
(23)	1	-1
(13)	1	-1

For this example the corollary below will say that these two functions on \mathfrak{S}_3 , together with the four functions listed earlier for Example 2c, form an orthogonal set of six functions. They are not quite orthonormal since the four functions f listed earlier have $\|f\|_2 = \sqrt{\frac{1}{2}}$ relative to the *normalized* counting measure. The interpretation of $\sqrt{\frac{1}{2}}$ is that its square is the reciprocal of the dimension of the underlying vector space.

Corollary 6.29 (Schur orthogonality relations).

(a) Let Φ and Φ' be inequivalent irreducible unitary representations of a compact group G on finite-dimensional complex vector spaces V and V' , respectively, and let the understood inner products be denoted by (\cdot, \cdot) . Then

$$\int_G (\Phi(x)u, v) \overline{(\Phi'(x)u', v')} dx = 0 \quad \text{for all } u, v \in V \text{ and } u', v' \in V.$$

(b) Let Φ be an irreducible unitary representation on a finite-dimensional complex vector space V , and let the understood inner product be denoted by (\cdot, \cdot) . Then

$$\int_G (\Phi(x)u_1, v_1) \overline{(\Phi(x)u_2, v_2)} dx = \frac{(u_1, u_2) \overline{(v_1, v_2)}}{\dim V} \quad \text{for } u_1, v_1, u_2, v_2 \in V.$$

REMARK. The proof of (b) will make use of the notion of the “trace” of a square matrix or of a linear map from a finite-dimensional vector space V to itself. For an n -by- n square matrix A the **trace** is the sum of the diagonal entries. This is $(-1)^{n-1}$ times the coefficient of λ^{n-1} in the polynomial $\det(A - \lambda I)$. Because of the multiplicative property of the determinant, this polynomial is the same for A as for BAB^{-1} if B is invertible. Hence A and BAB^{-1} have the same trace. Then it follows that the **trace** $\text{Tr } L$ of a linear map L from V to itself is well defined as the trace of the matrix of the linear map relative to any basis. For further background about the trace, see Section II.5.

PROOF. (a) Let $l : V' \rightarrow V$ be any linear map, and form the linear map

$$L = \int_G \Phi(x)l\Phi'(x^{-1}) dx.$$

(This integration can be regarded as occurring for matrix-valued functions and is to be handled entry-by-entry.) Because of the left invariance of dx , we obtain $\Phi(y)L\Phi'(y^{-1}) = L$, so that $\Phi(y)L = L\Phi'(y)$ for all $y \in G$. By Proposition 6.26 and the assumed inequivalence, $L = 0$. Thus $(Lv', v) = 0$. For the particular choice of l as $l(w') = (w', u')u$, we have

$$\begin{aligned} 0 &= (Lv', v) = \int_G (\Phi(x)l\Phi'(x^{-1})v', v) dx \\ &= \int_G (\Phi(x)(\Phi'(x^{-1})v', u')u, v) dx = \int_G (\Phi(x)u, v) \overline{(\Phi'(x^{-1})v', u')} dx, \end{aligned}$$

and (a) results since $(\Phi'(x^{-1})v', u') = \overline{(\Phi'(x)u', v')}$.

(b) We proceed in the same way, starting from $l : V \rightarrow V$, and obtain $L = \lambda I$ from Corollary 6.27. Taking the trace of both sides, we find that

$$\lambda \dim V = \text{Tr } L = \text{Tr } l,$$

so that $\lambda = (\text{Tr } l) / \dim V$. Thus

$$(Lv_2, v_1) = \frac{\text{Tr } l}{\dim V} \overline{(v_1, v_2)}.$$

Choose $l(w) = (w, u_2)u_1$, so that $\text{Tr } l = (u_1, u_2)$. Then

$$\begin{aligned} \frac{(u_1, u_2)\overline{(v_1, v_2)}}{\dim V} &= \frac{\text{Tr } l}{\dim V} \overline{(v_1, v_2)} = (Lv_2, v_1) = \int_G (\Phi(x)l\Phi(x^{-1})v_2, v_1) dx \\ &= \int_G (\Phi(x)(\Phi(x^{-1})v_2, u_2)u_1, v_1) dx = \int_G (\Phi(x)u_1, v_1)(\Phi(x^{-1})v_2, u_2) dx, \end{aligned}$$

and (b) results since $(\Phi(x^{-1})v_2, u_2) = \overline{(\Phi(x)u_2, v_2)}$. \square

We can interpret Corollary 6.29 as follows. Let $\{\Phi^{(\alpha)}\}$ be a maximal set of mutually inequivalent finite-dimensional irreducible unitary representations of the compact group G . For each $\Phi^{(\alpha)}$, choose an orthonormal basis for the underlying vector space, and let $\Phi_{ij}^{(\alpha)}(x)$ be the matrix of $\Phi^{(\alpha)}(x)$ in this basis. Then the functions $\{\Phi_{ij}^{(\alpha)}(x)\}_{i,j,\alpha}$ form an orthogonal set in the space $L^2(G)$ of square integrable functions on G . In fact, if $d^{(\alpha)}$ denotes the **degree** of $\Phi^{(\alpha)}$ (i.e., the dimension of the underlying vector space), then $\{(d^{(\alpha)})^{1/2}\Phi_{ij}^{(\alpha)}(x)\}_{i,j,\alpha}$ is an orthonormal set in $L^2(G)$. The Peter–Weyl Theorem in the next section will generalize Parseval’s Theorem in the subject of Fourier series by showing that this orthonormal set is an orthonormal basis.

We can use Schur orthogonality to get a qualitative idea of the decomposition into irreducible representations in Corollary 6.25 when Φ is a given finite-dimensional representation of the compact group G . By Proposition 6.24 there is no loss of generality in assuming that Φ is unitary. If Φ is a unitary finite-dimensional representation of G , a **matrix coefficient** of Φ is any function on G of the form $(\Phi(x)u, v)$. The **character** or **group character** of Φ is the function

$$\chi_\Phi(x) = \text{Tr } \Phi(x) = \sum_j (\Phi(x)u_j, u_j),$$

where $\{u_j\}$ is an orthonormal basis. This function depends only on the equivalence class of Φ and satisfies

$$\chi_\Phi(gxg^{-1}) = \chi_\Phi(x) \quad \text{for all } g, x \in G.$$

If Φ is the direct sum of representations Φ_1, \dots, Φ_n , then

$$\chi_\Phi = \chi_{\Phi_1} + \dots + \chi_{\Phi_n}.$$

Any multiplicative character is the group character of the corresponding 1-dimensional representation.

EXAMPLE 4, CONTINUED. Characters for $SU(2)$. Let Φ_n be the representation of $SU(2)$ on the homogeneous holomorphic polynomials of degree n in z_1 and z_2 . A basis for V consists of the monomials $z_1^k z_2^{n-k}$ for $0 \leq k \leq n$, and we easily check that Φ of the diagonal matrix $t_\theta = \text{diag}(e^{i\theta}, e^{-i\theta})$ has $z_1^k z_2^{n-k}$ as an eigenvector with eigenvalue $e^{i(n-2k)\theta}$. Therefore

$$\chi_{\Phi_n}(t_\theta) = \text{Tr } \Phi_n(t_\theta) = e^{in\theta} + e^{i(n-2)\theta} + \dots + e^{-in\theta}.$$

Every element of $SU(2)$ is conjugate to some matrix t_θ , and therefore this formula determines χ_{Φ_n} on all of $SU(2)$.

Corollary 6.30. If G is a compact group, then the character χ of an irreducible finite-dimensional representation has L^2 norm satisfying $\|\chi\|_2 = 1$. If χ and χ' are characters of inequivalent irreducible finite-dimensional representations, then $\int_G \chi(x) \overline{\chi'(x)} dx = 0$.

PROOF. These formulas are immediate from Corollary 6.29 since characters are sums of matrix coefficients. \square

Now let Φ be a given finite-dimensional representation of G , and write Φ as the direct sum of irreducible representations Φ_1, \dots, Φ_n . If τ is an irreducible finite-dimensional representation of G , then the sum formula for characters, together with Corollary 6.30, shows that $\int_G \chi_\Phi(x) \overline{\chi_\tau(x)} dx$ is the number of summands Φ_i equivalent to τ . Evidently this integer is independent of the decomposition of Φ into irreducible representations. It is called the **multiplicity** of τ in Φ .

7. Peter–Weyl Theorem

The goal of this section is to extend Parseval's Theorem for the circle group $S^1 = \mathbb{R}/2\pi\mathbb{Z}$ to a theorem valid for all compact groups. The extension is the Peter–Weyl Theorem. We continue with the notation of the previous section, letting G be the group, dx be a two-sided Haar measure normalized to have total measure one, and, in cases when G is not separable, working with Baire measurable functions rather than Borel measurable functions.

For S^1 , we observed in Corollary 6.28 that the irreducible finite-dimensional representations are 1-dimensional, hence are given by multiplicative characters. The exponential functions $x \mapsto e^{inx}$ are examples of multiplicative characters, and it is an exercise in real-variable theory, not hard, to prove that there are no other examples. The matrix coefficients of the 1-dimensional representations are just the same exponential functions $x \mapsto e^{inx}$. The Peter–Weyl Theorem specialized to this group says that the vector space of finite linear combinations

of exponential functions is dense in $L^2(S^1)$; the statement is a version of Fejér's Theorem for L^2 but without the precise detail of Fejér's Theorem. In view of the known orthogonality of the exponential functions, an equivalent formulation of the result for S^1 is that $\{e^{inx}\}_{n=-\infty}^{\infty}$ is a maximal orthonormal set in $L^2(S^1)$. By Hilbert-space theory, $\{e^{inx}\}_{n=-\infty}^{\infty}$ is an orthonormal basis of $L^2(S^1)$. For general compact G , the Peter–Weyl Theorem asserts that the vector space of finite linear combinations of all matrix coefficients of all irreducible finite-dimensional representations is again dense in $L^2(G)$. The new ingredient is that we must allow irreducible representations of dimension > 1 ; indeed, examination of the group \mathfrak{S}_3 shows that the 1-dimensional representations are not enough. An equivalent formulation in terms of orthonormal bases will be given in Corollary 6.32 below and will use Schur orthogonality (Corollary 6.29).

Theorem 6.31 (Peter–Weyl Theorem). If G is a compact group, then the linear span of all matrix coefficients for all finite-dimensional irreducible unitary representations of G is dense in $L^2(G)$.

PROOF. If $h(x) = (\Phi(x)u, v)$ is such a matrix coefficient, then the following functions of x are also matrix coefficients for the same representation:

$$\begin{aligned}\overline{h(x^{-1})} &= (\Phi(x)v, u), \\ h(gx) &= (\Phi(x)u, \Phi(g^{-1})v), \\ h(xg) &= (\Phi(x)\Phi(g)u, v).\end{aligned}$$

Then the closure U in $L^2(G)$ of the linear span of all matrix coefficients of all finite-dimensional irreducible unitary representations is stable under the map $h(x) \mapsto \overline{h(x^{-1})}$ and under left and right translation. Arguing by contradiction, suppose that $U \neq L^2(G)$. Then $U^\perp \neq 0$, and U^\perp is closed under $h(x) \mapsto \overline{h(x^{-1})}$ and under left and right translation.

We first prove that there is a nonzero continuous function in U^\perp . Thus let $H \neq 0$ be in U^\perp . For each open neighborhood N of 1 that is a G_δ , we define

$$f_N(x) = \frac{1}{|N|}(I_N * H)(x) = \frac{1}{|N|} \int_G I_N(y)H(y^{-1}x) dy,$$

where I_N is the indicator function of N and $|N|$ is the Haar measure of N . Since I_N and H are in $L^2(G)$, Proposition 6.20 shows that f_N is continuous. As N shrinks to $\{1\}$, the functions f_N tend to H in L^2 by the usual approximate-identity argument; hence some f_N is not 0. Finally each linear combination of left translates of H is in U^\perp , and f_N is therefore in U^\perp by Proposition 6.22.

Thus U^\perp contains a nonzero continuous function. Using translations and scalar multiplications, we can adjust this function so that it becomes a continuous function F_1 in U^\perp with $F_1(1)$ real and nonzero. Set

$$F_2(x) = \int_G F_1(yxy^{-1}) dy.$$

Then F_2 is continuous, $F_2(gxg^{-1}) = F_2(x)$ for all $g \in G$, and $F_2(1) = F_1(1)$ is real and nonzero. To see that F_2 is in U^\perp , we argue as follows: Corollary 6.7 shows that the map $(g, g') \mapsto F_1(g(\cdot)g')$ is continuous from $G \times G$ into $C(G)$, and hence the restriction $y \mapsto F_1(y(\cdot)y^{-1})$ is continuous from G into $C(G)$. The domain is compact, and therefore the image is compact, hence totally bounded. Consequently if $\epsilon > 0$ is given, then there exist y_1, \dots, y_n such that each $y \in G$ has some y_j such that $\|F_1(y(\cdot)y^{-1}) - F_1(y_j(\cdot)y_j^{-1})\|_{\text{sup}} < \epsilon$. Let E_j be the subset of y 's such that j is the first index for which this happens, and let $|E_j|$ be its Haar measure. Then

$$\begin{aligned} & \left| \int_G F_1(yxy^{-1}) dy - \sum_j |E_j| F_1(y_jxy_j^{-1}) \right| \\ &= \left| \sum_j \int_{E_j} [F_1(yxy^{-1}) - F_1(y_jxy_j^{-1})] dy \right| \\ &\leq \sum_j \int_{E_j} |F_1(yxy^{-1}) - F_1(y_jxy_j^{-1})| dy \leq \sum_j \epsilon \int_{E_j} dy = \epsilon, \end{aligned}$$

and we see that F_2 is the uniform limit of finite linear combinations of group conjugates of F_1 . Each such finite linear combination is in U^\perp , and hence F_2 is in U^\perp .

Finally put

$$F(x) = F_2(x) + \overline{F_2(x^{-1})}.$$

Then F is continuous and is in U^\perp , $F(gxg^{-1}) = F(x)$ for all $g \in G$, $F(1) = 2F_2(1)$ is real and nonzero, and $F(x) = \overline{F(x^{-1})}$. In particular, F is not the 0 function in $L^2(G)$.

Form the continuous function $K(x, y) = F(x^{-1}y)$ and the integral operator

$$Tf(x) = \int_G K(x, y)f(y) dy = \int_G F(x^{-1}y)f(y) dy \quad \text{for } f \in L^2(G).$$

Then $K(x, y) = \overline{K(y, x)}$ and $\int_{G \times G} |K(x, y)|^2 dx dy < \infty$. Also, T is not 0 since $F \neq 0$. The Hilbert–Schmidt Theorem (Theorem 2.4) applies to T as a linear operator from $L^2(G)$ to itself, and there must be a real nonzero eigenvalue λ , the corresponding eigenspace $V_\lambda \subseteq L^2(G)$ being finite dimensional.

Let us see that the subspace V_λ is invariant under left translation by g , which we write as $(L(g)f)(x) = f(g^{-1}x)$. In fact, f in V_λ implies

$$\begin{aligned} TL(g)f(x) &= \int_G F(x^{-1}y)f(g^{-1}y) dy = \int_G F(x^{-1}gy)f(y) dy \\ &= Tf(g^{-1}x) = \lambda f(g^{-1}x) = \lambda L(g)f(x). \end{aligned}$$

By Proposition 6.19, $g \mapsto L(g)f$ is continuous from G into $L^2(G)$, and therefore L is a representation of G in the finite-dimensional space V_λ . By dimensionality, V_λ contains an irreducible invariant subspace $W_\lambda \neq 0$.

Let (f_1, \dots, f_n) be an ordered orthonormal basis of W_λ . The matrix coefficients for W_λ are the functions

$$h_{ij}(x) = (L(x)f_j, f_i) = \int_G f_j(x^{-1}y) \overline{f_i(y)} dy$$

and by definition are in U . Since F is in U^\perp , we have

$$\begin{aligned} 0 &= \int_G F(x) \overline{h_{ii}(x)} dx = \int_G \int_G F(x) \overline{f_i(x^{-1}y)} f_i(y) dy dx \\ &= \int_G \int_G F(x) \overline{f_i(x^{-1}y)} f_i(y) dx dy \\ &= \int_G \int_G F(yx^{-1}) \overline{f_i(x)} f_i(y) dx dy \\ &= \int_G \left[\int_G F(x^{-1}y) f_i(y) dy \right] \overline{f_i(x)} dx && \text{since } F(gxg^{-1}) = F(x) \\ &= \int_G [Tf_i(x)] \overline{f_i(x)} dx = \lambda \int_G |f_i(x)|^2 dx \end{aligned}$$

for all i , in contradiction to the fact that $W_\lambda \neq 0$. We conclude that $U^\perp = 0$ and therefore that $U = L^2(G)$. \square

Corollary 6.32. If $\{\Phi^{(\alpha)}\}$ is a maximal set of mutually inequivalent finite-dimensional irreducible unitary representations of a compact group G and if $\{(d^{(\alpha)})^{1/2} \Phi_{ij}^{(\alpha)}(x)\}_{i,j,\alpha}$ is a corresponding orthonormal set of matrix coefficients, then $\{(d^{(\alpha)})^{1/2} \Phi_{ij}^{(\alpha)}(x)\}_{i,j,\alpha}$ is an orthonormal basis of $L^2(G)$. Consequently any f in $L^2(G)$ has the property that

$$\|f\|_2^2 = \sum_\alpha \sum_{i,j} d_\alpha |(f, \Phi_{ij}^{(\alpha)})|^2,$$

where (\cdot, \cdot) is the L^2 inner product.

REMARK. The displayed formula, which extends Parseval's Theorem from S^1 to the compact group G , is called the **Plancherel formula** for G .

PROOF. The linear span of the orthonormal set in question equals the linear span of all matrix coefficients for all finite-dimensional irreducible unitary representations of G . Theorem 6.31 implies that the orthonormal set is maximal. Hilbert-space theory then shows that the orthonormal set is an orthonormal basis and that Parseval's equality holds, and the latter fact yields the corollary. \square

As is implicit in the proof of Corollary 6.32, the partial sums in the expansion of f in terms of the orthonormal set of normalized matrix coefficients are converging to f in $L^2(G)$. The next result along these lines gives an analog of Fejér's Theorem for Fourier series of continuous functions. Taking a cue from the theory of Fourier series, let us refer to any finite linear combination of the functions $\Phi_{ij}^{(\alpha)}(x)$ in the above corollary as a **trigonometric polynomial**.

Corollary 6.33 (Approximation Theorem). There exists a net $T^{(\beta)}$ of uniformly bounded linear operators from $C(G)$ into itself such that for every f in $C(G)$, $T^{(\beta)}f$ is a trigonometric polynomial for each β and $\lim_{\beta} T^{(\beta)}f = f$ uniformly on G .

PROOF. The directed set will consist of pairs $\beta = (N, \epsilon)$, where N is an open G_{δ} containing the identity of G and where $1 \geq \epsilon > 0$, and the partial ordering is that $(N, \epsilon) \leq (N', \epsilon')$ if $N \supseteq N'$ and $\epsilon \geq \epsilon'$. If $\beta = (N, \epsilon)$ is given, let $|N|$ be the Haar measure of N , and let $\psi_N = |N|^{-1}I_N$ be the positive multiple of the indicator function of N that makes ψ_N have $\|\psi_N\|_1 = 1$. Since ψ_N is in $L^2(G)$, Theorem 6.31 shows that we can find a trigonometric polynomial φ_{β} such that $\|\psi_N - \varphi_{\beta}\|_2 \leq \epsilon$. The operator $T^{(\beta)}$ will be given by convolution: $T^{(\beta)}f = \varphi_{\beta} * f$.

Since $\|\psi_N - \varphi_{\beta}\|_1 \leq \|\psi_N - \varphi_{\beta}\|_2 \leq \epsilon \leq 1$, we have $\|\varphi_{\beta}\|_1 \leq 2$. Therefore the operator norm of $T^{(\beta)}$ on $C(G)$ is ≤ 2 .

To see that $T^{(\beta)}f$ converges uniformly to f , we use a variant of a familiar argument with approximate identities. We write

$$\|T^{(\beta)}f - f\|_{\text{sup}} \leq \|(\varphi_{\beta} - \psi_N) * f\|_{\text{sup}} + \|\psi_N * f - f\|_{\text{sup}}.$$

The first term on the right is $\leq \|\varphi_{\beta} - \psi_N\|_1 \|f\|_{\text{sup}} \leq \|\varphi_{\beta} - \psi_N\|_2 \|f\|_{\text{sup}} \leq \epsilon \|f\|_{\text{sup}}$. For the second term we have

$$\begin{aligned} |\psi_N * f(x) - f(x)| &= \left| \int_G \psi_N(y)[f(y^{-1}x) - f(x)] dy \right| \\ &\leq \int_G \psi_N(y) |f(y^{-1}x) - f(x)| dy \\ &= |N|^{-1} \int_N |f(y^{-1}x) - f(x)| dy \\ &\leq \sup_{y \in N} |f(y^{-1}x) - f(x)|, \end{aligned}$$

and Proposition 6.6 shows that this expression tends to 0 as N shrinks to $\{1\}$.

Finally we show that $T^{(\beta)}f$ is a trigonometric polynomial, i.e., that there are only finitely many irreducible representations Φ , up to equivalence, such that the L^2 inner product $(T^{(\beta)}f, \Phi_{ij})$ can be nonzero. This inner product is equal to

$$\begin{aligned} \int_G (\varphi_{\beta} * f)(x) \overline{\Phi_{ij}(x)} dx &= \iint_{G \times G} \varphi_{\beta}(xy^{-1}) f(y) \overline{\Phi_{ij}(x)} dx dy \\ &= \iint_{G \times G} \varphi_{\beta}(x) f(y) \overline{\Phi_{ij}(xy)} dx dy \\ &= \sum_k \iint_{G \times G} \varphi_{\beta}(x) f(y) \overline{\Phi_{ik}(x)} \overline{\Phi_{kj}(y)} dx dy \\ &= \sum_k \int_G f(y) \overline{\Phi_{kj}(y)} \left[\int_G \varphi_{\beta}(x) \overline{\Phi_{ik}(x)} dx \right] dy, \end{aligned}$$

and Schur orthogonality (Corollary 6.29) shows that the expression in brackets is 0 unless Φ is equivalent to one of the irreducible representations whose matrix coefficients contribute to φ_{β} . \square

8. Fourier Analysis Using Compact Groups

In the discussion of the representation theory of compact groups in the previous two sections, all the representations were finite dimensional. A number of applications of compact groups to analysis, however, involve naturally arising infinite-dimensional representations, and a theory of such representations is needed. We address this problem now, and we illustrate how the theory of infinite-dimensional representations can be used to simplify analysis problems having a compact group of symmetries.

We continue with the notation of the previous two sections, letting G be the compact group and dx be a two-sided Haar measure normalized to have total measure one. In cases in which G is not separable, we work with Baire measurable functions rather than Borel measurable functions.

Recall from Section II.4 and Proposition 2.6 that if V is a complex Hilbert space with inner product (\cdot, \cdot) and norm $\|\cdot\|$, then a unitary operator U on V is a bounded linear operator from V into itself such that U^* is a two-sided inverse of U , or equivalently is a linear operator from V to itself that preserves norms and is onto V , or equivalently is a linear operator from V to itself that preserves inner products and is onto V .

From the definition the unitary operators on V form a group. Unlike what happens with the N -by- N unitary group $U(N)$, this group is not compact if V is infinite-dimensional. A **unitary representation** of G on the complex Hilbert space V is a homomorphism of G into the group of unitary operators on V such that a certain continuity property holds. Continuity is a more subtle matter in the present context than it was in the finite-dimensional case because not all possible definitions of continuity are equivalent here. The continuity property we choose is that the group action $G \times V \rightarrow V$, given by $g \times v \mapsto \Phi(g)v$, is continuous. When Φ is unitary, this property is equivalent to **strong continuity**, namely that $g \mapsto \Phi(g)v$ is continuous for every v in V .

Let us see this equivalence. Strong continuity results from fixing the V variable in the definition of continuity of the group action, and therefore continuity of the group action implies strong continuity. In the reverse direction the triangle inequality and the equality $\|\Phi(g)\| = 1$ give

$$\begin{aligned} \|\Phi(g)v - \Phi(g_0)v_0\| &\leq \|\Phi(g)(v - v_0)\| + \|\Phi(g)v_0 - \Phi(g_0)v_0\| \\ &= \|v - v_0\| + \|\Phi(g)v_0 - \Phi(g_0)v_0\|, \end{aligned}$$

and it follows that strong continuity implies continuity of the group action.

With this definition of continuity in place, an example of a unitary representation is the **left-regular representation** of G on the complex Hilbert space $L^2(G)$, given by $(l(g)f)(x) = f(g^{-1}x)$. Strong continuity is satisfied according

to Proposition 6.19. The **right-regular representation** of G on $L^2(G)$, given by $(r(g)f)(x) = f(xg)$, also satisfies this continuity property.

In working with a unitary representation Φ of G on V , it is helpful to define $\Phi(f)$ for f in $L^1(G)$ as a smeared-out version of the various $\Phi(x)$'s for x in G . Formally $\Phi(f)$ is to be $\int_G f(x)\Phi(x) dx$. But to avoid integrating functions whose values are in an infinite-dimensional space, we define $\Phi(f)$ as follows: The function $\int_G f(x)(\Phi(x)v, v') dx$ of v and v' is linear in v , conjugate linear in v' , and bounded in the sense that $|\int_G f(x)(\Phi(x)v, v') dx| \leq \|f\|_1 \|v\| \|v'\|$. Hilbert-space theory shows as a consequence¹¹ that there exists a unique linear operator $\Phi(f)$ such that

$$(\Phi(f)v, v') = \int_G f(x)(\Phi(x)v, v') dx \quad \text{for all } v \text{ and } v' \text{ in } V$$

and that this operator is bounded with

$$\|\Phi(f)\| \leq \|f\|_1.$$

From the existence and uniqueness of $\Phi(f)$, it follows that $\Phi(f)$ depends linearly on f .

Let us digress for a moment to consider $\Phi(f)$ if Φ happens to be finite-dimensional. If $\{u_i\}$ is an ordered orthonormal basis of the underlying finite-dimensional vector space, then the matrix corresponding to $\Phi(f)$ in this basis has (i, j) th entry $(\Phi(f)u_i, u_j) = \int_G f(x)(\Phi(x)u_i, u_j) dx$. The expression

$$\sum_{i,j} |(\Phi(f)u_i, u_j)|^2 = \sum_{i,j} \left| \int_G f(x)(\Phi(x)u_i, u_j) dx \right|^2$$

is, on the one hand, the kind of term that appears in the Plancherel formula in Corollary 6.32 and, on the other hand, is what in Section II.5 was called the Hilbert–Schmidt norm squared $\|\Phi(f)\|_{\text{HS}}^2$ of $\Phi(f)$. It has to be independent of the basis here in order to yield consistent formulas as we change orthonormal bases, and that independence of basis was proved in Section II.5. Using the Hilbert–Schmidt norm, we can rewrite the **Plancherel formula** in Corollary 6.32 as

$$\|f\|^2 = \sum_{\alpha} d_{\alpha} \|\Phi^{(\alpha)}(f)\|_{\text{HS}}^2.$$

Unlike the formula in Corollary 6.32, this formula is canonical, not depending on any choice of bases.

¹¹See the remarks near the beginning of Section XII.3 of *Basic*.

Returning from our digression, let us again allow Φ to be infinite-dimensional. The mapping $f \mapsto \Phi(f)$ for f in $L^1(G)$ has two other properties of note. The first is that

$$\Phi(f)^* = \Phi(f^*),$$

where $f^*(x) = \overline{f(x^{-1})}$. To prove this formula, we simply write everything out:

$$\begin{aligned} (\Phi(f)^*v, v') &= (v, \Phi(f)v') = \int_G (v, f(x)\Phi(x)v') dx \\ &= \int_G \overline{f(x)}(v, \Phi(x)v') dx = \int_G \overline{f(x^{-1})}(v, \Phi(x^{-1})v') dx \\ &= \int_G f^*(x)(\Phi(x)v, v') dx = (\Phi(f^*)v, v'). \end{aligned}$$

The other property concerns convolution and is that

$$\Phi(f * h) = \Phi(f)\Phi(h).$$

The formal computation to prove this is

$$\begin{aligned} \Phi(f * h) &= \int_G \int_G f(xy^{-1})h(y)\Phi(x) dy dx = \int_G \int_G f(xy^{-1})h(y)\Phi(x) dx dy \\ &= \int_G \int_G f(x)h(y)\Phi(xy) dx dy = \int_G \int_G f(x)h(y)\Phi(x)\Phi(y) dx dy \\ &= \Phi(f)\Phi(h). \end{aligned}$$

To make this computation rigorous, we put the appropriate inner products in place and use Fubini's Theorem to justify the interchange of order of integration:

$$\begin{aligned} &(\Phi(f * h)v, v') \\ &= \int_G \int_G f(xy^{-1})h(y)(\Phi(x)v, v') dy dx = \int_G \int_G f(xy^{-1})h(y)(\Phi(x)v, v') dx dy \\ &= \int_G \int_G f(x)h(y)(\Phi(xy)v, v') dx dy = \int_G \int_G f(x)h(y)(\Phi(x)\Phi(y)v, v') dx dy \\ &= \int_G \int_G f(x)h(y)(\Phi(y)v, \Phi(x)^*v') dx dy \\ &= \int_G \int_G f(x)h(y)(\Phi(y)v, \Phi(x)^*v') dy dx = \int_G f(x)(\Phi(h)v, \Phi(x)^*v') dx \\ &= \int_G f(x)(\Phi(x)\Phi(h)v, v') dx = (\Phi(f)\Phi(h)v, v'). \end{aligned}$$

This kind of computation translating a formal argument about $\Phi(f)$ into a rigorous argument is one that we shall normally omit from now on.

An important instance of a convolution $f * h$ is the case that f and h are characters of irreducible finite-dimensional representations. The formula in this case is

$$\chi_\tau * \chi_{\tau'} = \begin{cases} d_\tau^{-1} \chi_\tau & \text{if } \tau \cong \tau' \text{ and } d_\tau \text{ is the degree of } \tau, \\ 0 & \text{if } \tau \text{ and } \tau' \text{ are inequivalent.} \end{cases}$$

This follows by expanding the characters in terms of matrix coefficients and computing the integrals using Schur orthogonality (Corollary 6.29).

If $f \geq 0$ vanishes outside an open neighborhood N of 1 that is a G_δ in G and if $\int_G f(x) dx = 1$, then $(\Phi(f)v - v, v') = \int_G f(x)(\Phi(x)v - v, v') dx$. When $\|v'\| \leq 1$, the Schwarz inequality therefore gives

$$|(\Phi(f)v - v, v')| \leq \int_N f(x) \|\Phi(x)v - v\| \|v'\| dx \leq \sup_{x \in N} \|\Phi(x)v - v\|.$$

Taking the supremum over v' with $\|v'\| \leq 1$ allows us to conclude that

$$\|\Phi(f)v - v\| \leq \sup_{x \in N} \|\Phi(x)v - v\|.$$

We shall make use of this inequality shortly.

An **invariant subspace** for a unitary representation Φ on V is, just as in the finite-dimensional case, a vector subspace U such that $\Phi(g)U \subseteq U$ for all $g \in G$. This notion is useful mainly when U is a closed subspace. In any event if U is invariant, so is the closed orthogonal complement U^\perp since $u^\perp \in U^\perp$ and $u \in U$ imply that

$$(\Phi(g)u^\perp, u) = (u^\perp, \Phi(g)^*u) = (u^\perp, \Phi(g)^{-1}u) = (u^\perp, \Phi(g^{-1})u)$$

is in $(u^\perp, U) = 0$. If $V \neq 0$, the representation is **irreducible** if its only closed invariant subspaces are 0 and V .

Two unitary representations of G , Φ on V and Φ' on V' , are said to be **equivalent** if there is a bounded linear $E : V \rightarrow V'$ with a bounded inverse such that $\Phi'(g)E = E\Phi(g)$ for all $g \in G$.

Theorem 6.34. If Φ is a unitary representation of the compact group G on a complex Hilbert space V , then V is the orthogonal sum of finite-dimensional irreducible invariant subspaces.

REMARK. The new content of the theorem is for the case that V is infinite dimensional. The theorem says that if one takes the union of orthonormal bases for each of certain finite-dimensional irreducible invariant subspaces, then the result is an orthonormal basis of V .

PROOF. By Zorn's Lemma, choose a maximal orthogonal set of finite-dimensional irreducible invariant subspaces, and let U be the closure of the sum. Arguing by contradiction, suppose that U is not all of V . Then U^\perp is a nonzero closed invariant subspace. Fix $v \neq 0$ in U^\perp . For each open neighborhood N of 1 that is a G_δ in G , let f_N be the indicator function of N divided by the measure of N . Then f_N is an integrable function ≥ 0 with integral 1. It is immediate from

the definition of $(\Phi(f_N)v, u)$ that $\Phi(f_N)v$ is in U^\perp for every N and every $u \in U$. The inequality $\|\Phi(f_N)v - v\| \leq \sup_{x \in N} \|\Phi(x)v - v\|$ and strong continuity of Φ show that $\Phi(f_N)v$ tends to v as N shrinks to $\{1\}$. Hence some $\Phi(f_N)v$ is not 0. Fix such an N .

Choose by the Peter–Weyl Theorem (Theorem 6.31) a function h in the linear span of all matrix coefficients for all finite-dimensional irreducible unitary representations such that $\|f_N - h\|_2 \leq \frac{1}{2} \|\Phi(f_N)v\| / \|v\|$. Then

$$\begin{aligned} \|\Phi(f_N)v - \Phi(h)v\| &= \|\Phi(f_N - h)v\| \leq \|f_N - h\|_1 \|v\| \\ &\leq \|f_N - h\|_2 \|v\| \leq \frac{1}{2} \|\Phi(f_N)v\|. \end{aligned}$$

Hence

$$\|\Phi(h)v\| \geq \|\Phi(f_N)v\| - \|\Phi(f_N)v - \Phi(h)v\| \geq \frac{1}{2} \|\Phi(f_N)v\| > 0,$$

and $\Phi(h)v$ is not 0.

The function h lies in some finite-dimensional vector subspace S of $L^2(G)$ that is invariant under left translation. Let h_1, \dots, h_n be a basis of S , and write $h_j(g^{-1}x) = \sum_{i=1}^n c_{ij}(g)h_i(x)$. The formal computation

$$\begin{aligned} \Phi(g)\Phi(h_j)v &= \Phi(g) \int_G h_j(x)\Phi(x)v \, dx = \int_G h_j(x)\Phi(gx)v \, dx \\ &= \int_G h_j(g^{-1}x)\Phi(x)v \, dx = \sum_{i=1}^n c_{ij}(g) \int_G h_i(x)\Phi(x)v \, dx \\ &= \sum_{i=1}^n c_{ij}(g)\Phi(h_i)v \end{aligned}$$

suggests that the vector subspace $\sum_{j=1}^n \mathbb{C}\Phi(h_j)v$, which is finite dimensional and lies in U^\perp , is an invariant subspace for Φ containing the nonzero vector $\Phi(h)v$. To justify the formal computation, we argue as in the proof of the formula $\Phi(f * h) = \Phi(f)\Phi(h)$, redoing the calculation with an inner product with v' in place throughout. The existence of this subspace of U^\perp contradicts the maximality of U and proves the theorem. \square

Corollary 6.35. Every irreducible unitary representation of a compact group is finite dimensional.

PROOF. This is immediate from Theorem 6.34. \square

Corollary 6.36. Let Φ be a unitary representation of the compact group G on a complex Hilbert space V . For each irreducible unitary representation τ of G , let E_τ be the orthogonal projection on the sum of all irreducible invariant subspaces of V that are equivalent to τ . Then E_τ is given by $d_\tau \Phi(\overline{\chi_\tau})$, where d_τ is the degree of τ and χ_τ is the character of τ , and the image of E_τ is the orthogonal

sum of irreducible invariant subspaces that are equivalent to τ . Moreover, if τ and τ' are inequivalent, then $E_\tau E_{\tau'} = E_{\tau'} E_\tau = 0$. Finally every v in V satisfies

$$v = \sum_{\tau} E_\tau v,$$

with the sum an infinite sum over a set of representatives τ of all equivalence classes of irreducible unitary representations of G and taken in the sense of convergence in the Hilbert space.

REMARK. For each τ , the projection E_τ is called the orthogonal projection on the **isotypic subspace** of type τ .

PROOF. Let τ be irreducible with degree d_τ , and put $E'_\tau = d_\tau \Phi(\overline{\chi_\tau})$. Our formulas for characters and for operators $\Phi(f)$ give us the two formulas

$$\begin{aligned} E'_\tau E'_{\tau'} &= d_\tau d_{\tau'} \Phi(\overline{\chi_\tau}) \Phi(\overline{\chi_{\tau'}}) = d_\tau d_{\tau'} \Phi(\overline{\chi_\tau * \chi_{\tau'}}) = 0 \quad \text{if } \tau \not\cong \tau', \\ E'^2_\tau &= d_\tau^2 \Phi(\overline{\chi_\tau * \chi_\tau}) = d_\tau \Phi(\overline{\chi_\tau}) = E'_\tau. \end{aligned}$$

The first of these says that $E'_\tau E'_{\tau'} = E'_{\tau'} E'_\tau = 0$ if τ and τ' are inequivalent, and the second says that E'_τ is a projection. In fact, E'_τ is self adjoint and is therefore an orthogonal projection. To see the self-adjointness, we let $\{u_i\}$ be an orthonormal basis of the vector space on which τ operates by unitary transformations. Then $\overline{\chi_\tau}^*(x) = \chi_\tau(x^{-1}) = \sum_i (\tau(x^{-1})u_i, u_i) = \sum_i \overline{(u_i, \tau(x^{-1})u_i)} = \sum_i \overline{(\tau(x)u_i, u_i)} = \overline{\chi_\tau(x)}$. Therefore

$$E'^*_\tau = d_\tau \Phi(\overline{\chi_\tau})^* = d_\tau \Phi(\overline{\chi_\tau}^*) = d_\tau \Phi(\overline{\chi_\tau}) = E'_\tau,$$

and the projection $E_{\tau'}$ is an orthogonal projection.

Let U be an irreducible finite-dimensional subspace of V on which $\Phi|_U$ is equivalent to τ , and let u_1, \dots, u_n be an orthonormal basis of U . If we write $\Phi(x)u_j = \sum_{i=1}^n \Phi_{ij}(x)u_i$, then $\Phi_{ij}(x) = (\Phi(x)u_j, u_i)$ and $\chi_\tau(x) = \sum_{i=1}^n \Phi_{ii}(x)$. Thus a formal computation with Schur orthogonality gives

$$E'_\tau u_j = d_\tau \int_G \overline{\chi_\tau(x)} \Phi(x)u_j dx = d_\tau \int_G \sum_{i,k} \overline{\Phi_{kk}(x)} \Phi_{ij}(x)u_i dx = u_j,$$

and we can justify this computation by using inner products with v' throughout. As a result, we see that E'_τ is the identity on every irreducible subspace of type τ .

Now let us apply E'_τ to a Hilbert space orthogonal sum $V = \sum V_\alpha$ of the kind in Theorem 6.34. We have just seen that E'_τ is the identity on V_α if V_α is of type τ . If V_α is of type τ' with τ' not equivalent to τ , then E'_τ is the identity on V_α , and we have $E'_\tau u = E'_\tau E'_{\tau'} u = 0$ for all $u \in V_\alpha$. Consequently E'_τ is 0 on V_α , and we conclude that $E'_\tau = E_\tau$. This completes the proof. \square

EXAMPLE. The right-regular representation r of G on $L^2(G)$. Let τ be an abstract irreducible unitary representation of G , let (u_1, \dots, u_n) be an ordered orthonormal basis of the space on which τ acts, and form matrices relative to

this basis that realize each $\tau(x)$. The formula is $\tau_{ij}(x) = (\tau(x)u_j, u_i)$. The computation $(r(g)\tau_{ij})(x) = \tau_{ij}(xg) = \sum_k \tau_{ik}(x)\tau_{kj}(g) = \sum_{i'} \tau_{i'j}(g)\tau_{ii'}(x)$ shows that the matrix coefficients corresponding to a fixed row, those with i fixed and j varying, form an invariant subspace for r . The matrix of this representation is $[\tau_{i'j}(g)]$, and thus the representation is irreducible of type τ . Since these spaces are orthogonal to one another by Schur orthogonality, the dimension of the image of E_τ is at least d_τ^2 . On the other hand, Corollary 6.32 says that such matrix coefficients relative to an orthonormal basis, as τ varies through representatives of all equivalence classes of irreducible representations, form a maximal orthogonal system in $L^2(G)$. The coefficients corresponding to any τ' not equivalent to τ are in the image of $E_{\tau'}$ and are not of type τ . Therefore the orthogonal sum of the spaces of matrix coefficients for each fixed row equals the image of E_τ , and the dimension of the image equals d_τ^2 . The corollary tells us that the formula for the projection is $E_\tau f = r(d_\tau \overline{\chi_\tau})f$. To see what this is concretely, we use the definitions to compute that $(E_\tau f, h) = (r(d_\tau \overline{\chi_\tau})f, h) = \int_G d_\tau \overline{\chi_\tau}(x)(r(x)f, h) dx = \int_G \int_G d_\tau \overline{\chi_\tau}(x)(r(x)f)(y)h(y) dy dx = \int_G \int_G d_\tau \overline{\chi_\tau}(x)f(yx)h(y) dy dx = \int_G \int_G d_\tau \chi_\tau(x^{-1})f(yx)\overline{h(y)} dx dy = (f * d_\tau \chi_\tau, h)$. Therefore the orthogonal projection is given by $E_\tau f = f * d_\tau \chi_\tau$.

Corollary 6.36 is a useful result in taking advantage of symmetries in analysis problems. Imagine that the problem is to understand some linear operator on the space in question, and suppose that the space carries a representation of a compact group that commutes with the operator. This is exactly the situation with some of the examples of separation of variables in partial differential equations as in Section I.2. The idea is that under mild assumptions, the operator carries each isotypic subspace to itself. Hence the problem gets reduced to an understanding of the linear operator on each of the isotypic subspaces.

In order to have a concrete situation for purposes of illustration, let us assume that the linear operator is bounded, has domain the whole Hilbert space, and carries the space into itself. The following proposition then applies.

Proposition 6.37. Let $T : V \rightarrow V$ be a bounded linear operator on the Hilbert space V , and suppose that Φ is a unitary representation of the compact group G on V such that $T\Phi(g) = \Phi(g)T$ for all g in G . Let τ be an abstract irreducible unitary representation of G , and let E_τ be the orthogonal projection of V on the isotypic subspace of type τ . Then $TE_\tau = E_\tau T$.

PROOF. For v and v' in V , $(TE_\tau v, v')$ is equal to

$$\begin{aligned} (E_\tau v, T^*v') &= d_\tau \int_G \chi_\tau(x)(\Phi(x)v, T^*v') dx = d_\tau \int_G \chi_\tau(x)(T\Phi(x)v, v') dx \\ &= d_\tau \int_G \chi_\tau(x)(\Phi(x)Tv, v') dx = (E_\tau Tv, v') dx, \end{aligned}$$

and the result follows. \square

EXAMPLE. The Fourier transform on $L^2(\mathbb{R}^N)$ commutes with each member ρ of the orthogonal group $O(N)$ because if f has Fourier transform \widehat{f} , then $\widehat{f}(\rho y) = \int_{\mathbb{R}^N} f(x) e^{-2\pi i x \cdot \rho y} dx = \int_{\mathbb{R}^N} f(x) e^{-2\pi i \rho^{-1} x \cdot y} dx = \int_{\mathbb{R}^N} f(\rho x) e^{-2\pi i x \cdot y} dx$ says that $x \mapsto f(\rho x)$ has Fourier transform $y \mapsto \widehat{f}(\rho y)$. Proposition 6.37 says that the Fourier transform carries each isotypic subspace of $L^2(\mathbb{R}^N)$ under $O(N)$ into itself. Let us return to Example 5 in Section 6, in which we dealt with the vector space V_k of all polynomials on \mathbb{R}^N homogeneous of degree k . We saw that the vector subspace H_k of harmonic polynomials homogeneous of degree k is an invariant subspace under $O(N)$. In fact, more is true. One can show that H_k is irreducible and that the Laplacian Δ carries V_k onto $|x|^2 V_{k-2}$. It follows from the latter fact that the space of restrictions to the unit sphere S^{N-1} of all polynomials is the same as the space of restrictions to S^{N-1} of all harmonic polynomials, with each irreducible representation H_k of $O(N)$ occurring with multiplicity 1. Applying the Stone–Weierstrass Theorem on S^{N-1} and untangling matters, we find for $L^2(S^{N-1})$ that the isotypic subspaces under $O(N)$ are the restrictions of the members of H_k , each having multiplicity 1. Passing to $L^2(\mathbb{R}^N)$ and thinking in terms of spherical coordinates, we see that each relevant τ for $L^2(\mathbb{R}^N)$ is the representation on some H_k and that the image of E_τ is the space of L^2 functions that are finite linear combinations $\sum_j h_j f_j(|x|)$ of products of a member of H_k and a function of $|x|$, the members of H_k being linearly independent. According to the proposition, this image is carried to itself by the Fourier transform. The restriction of the Fourier transform to this image still commutes with members of $O(N)$, and the idea is to use Schur’s Lemma (Corollary 6.27) to show that the Fourier transform has to send any $h_j(x) f(|x|)$ to $h_j(x) g(|x|)$; the details are carried out in Problem 14 at the end of the chapter. Thus we can see on the basis of general principles that the Fourier transform formula reduces to a single 1-dimensional integral on each space corresponding to some H_k . Armed with this information, one can look for a specific integral formula, and the actual formula turns out to involve an integration and classical Bessel functions.¹²

CONCLUDING REMARKS. Proposition 6.37 and the above example are concerned with understanding a particular bounded linear operator, but realistic applications are more concerned with linear operators that are unbounded. For example, when the domain of a linear partial differential operator can be arranged in such a way that the operator is self adjoint and a compact group of symmetries operates, then one wants to exploit the symmetry group in order to express the space of all functions annihilated by the operator as the limit of the sum of those functions in an isotypic subspace. In mathematical physics the very hope that this kind of reduction is possible has itself been useful, even without knowing in advance the differential operator and the group of symmetries. The reason

¹²Bessel functions were defined in Section IV.8 of *Basic*.

is that numerical invariants of the compact group, such as the dimensions of some of the irreducible representations, appear in physical data. One can look for an appropriate group yielding those numerical invariants. This approach worked long ago in analyzing spin, it worked more recently in attempts to classify elementary particles, and it has been used still more recently in order to guess at the role of group theory in string theory.

9. Problems

1. Let G be a topological group.
 - (a) Prove that the connected component of the identity element of G , i.e., the union of all connected sets containing the identity, is a closed subgroup that is group-theoretically normal. This subgroup is called the **identity component** of G .
 - (b) Give an example of a topological group whose identity component is not open.
2. The rotation group $SO(N)$ acts continuously on the the unit sphere S^{N-1} in \mathbb{R}^N by matrix multiplication.
 - (a) Prove that the subgroup fixing the first standard basis vector is isomorphic to $SO(N - 1)$.
 - (b) Prove that the action by $SO(N)$ is transitive on S^{N-1} for $N \geq 2$.
 - (c) Deduce that there is a homeomorphism $SO(N)/SO(N - 1) \rightarrow S^{N-1}$ for $N \geq 2$ that respects the action by $SO(N)$.
3. Let G be a separable locally compact group, and suppose that G has a continuous transitive group action on a locally compact Hausdorff space X . Suppose that x_0 is in X and that H is the (closed) subgroup of G fixing x_0 , so that there is a one-one continuous map π of G/H onto X . Using the Baire Category Theorem for locally compact Hausdorff spaces (Problem 3 of Chapter X of *Basic*), prove that π is an open map and that π is therefore a homeomorphism.
4. Let G_1 and G_2 be separable locally compact groups, and let $\pi : G_1 \rightarrow G_2$ be a continuous one-one homomorphism onto. Prove that π is a homeomorphism.
5. Let $T^2 = \{(e^{i\theta}, e^{i\varphi})\}$. The line \mathbb{R}^1 acts on T^2 by

$$(x, (e^{i\theta}, e^{i\varphi})) \mapsto (e^{i\theta+ix}, e^{i\varphi+ix\sqrt{2}}).$$

Let p be the point $(1, 1)$ of T^2 corresponding to $\theta = \varphi = 0$. The mapping of \mathbb{R}^1 into T^2 given by $x \mapsto xp$ is one-one. Is it a homeomorphism? Explain.

6. Let G be a noncompact locally compact group, and let V be a bounded open set. By using the fact that G cannot be covered by finitely many left translates of V , prove that G must have infinite left Haar measure, i.e., that a Haar measure for a locally compact group can be finite only if the group is compact.

7. (a) Suppose that G is a compact group, λ is a left Haar measure, ρ is a right Haar measure, and E is a Baire set. By evaluating $\int_{G \times G} I_E(xy) d(\rho \times \lambda)(x, y)$ as an iterated integral in each order, prove that $\lambda(E)\rho(G) = \lambda(G)\rho(E)$.
- (b) Deduce the uniqueness of Haar measure for compact groups, together with the unimodularity, from (a) and the existence of left and right Haar measures for the group.
8. Suppose that $\{G_n\}_{n=1}^{\infty}$ is a sequence of separable compact groups. Let $G^{(n)} = G_1 \times \cdots \times G_n$, and let G be the direct product of all G_n . Let $\mu_n, \mu^{(n)}$, and μ be Haar measures on $G_n, G^{(n)}$, and G , all normalized to have total measure 1.
- (a) Why is $\mu^{(n)}$ equal to the product measure $\mu_1 \times \cdots \times \mu_n$?
- (b) Show that $\mu^{(n)}$ defines a measure on a certain σ -algebra of Borel sets of G that is consistent with μ .
- (c) Show that the smallest σ -algebra containing, for every n , the “certain σ -algebra of Borel sets of $G^{(n)}$ ” as in (b), is the σ -algebra of all Borel sets of G , so that μ can be regarded as the infinite product of μ_1, μ_2, \dots .
9. Let G be a locally compact topological group with a left Haar measure $d_l x$, and let Φ be an automorphism of G as a topological group, i.e., an automorphism of the group structure that is also a homeomorphism of G . Prove that there is a positive constant $a(\Phi)$ such that $d_l(\Phi(x)) = a(\Phi) d_l x$.
10. Let G be a locally compact group with two closed unimodular subgroups S and T such that $G = S \times T$ topologically and such that T is group-theoretically normal. Write elements of G as st with $s \in S$ and $t \in T$. Let ds and dt be Haar measures on S and T . Since $t \mapsto sts^{-1}$ is an automorphism of T for each $s \in S$, the previous problem produces a constant $\delta(s)$ such that $d(sts^{-1}) = \delta(s) dt$.
- (a) Prove that $ds dt$ is a left Haar measure for G .
- (b) Prove that $\delta(s) ds dt$ is a right Haar measure for G .
11. This problem leads to the same conclusion as Proposition 4.8, that any locally compact topological vector space over \mathbb{R} is finite-dimensional, but it gives a more conceptual proof than the one in Chapter IV. Let V be such a space. For each real $c \neq 0$, let $|c|_V$ be the constant $a(\Phi)$ from Problem 9 when the measure is an additive Haar measure for V and Φ is multiplication by c . Define $|0|_V = 0$.
- (a) Prove that $c \mapsto |c|_V$ is a continuous function from \mathbb{R} into $[0, +\infty)$ such that $|c_1 c_2|_V = |c_1|_V |c_2|_V$ and such that $|c_1| \leq |c_2|$ implies $|c_1|_V \leq |c_2|_V$.
- (b) If W is a closed vector subspace of V , use Theorem 6.18 to prove that $|c|_V = |c|_W |c|_{V/W}$.
- (c) Using (b), Proposition 4.5, Corollary 4.6, and the formula $|c|_{\mathbb{R}^N} = |c|^N$, prove that V has to be finite-dimensional.
12. Let Φ be a finite-dimensional unitary representation of a compact group G on a finite-dimensional inner-product space V . The members of the dual V^* are of the form $\ell_v = (\cdot, v)$ with v in V , by virtue of the Riesz Representation Theorem

- for Hilbert spaces. Define $(\ell_{v_1}, \ell_{v_2}) = (v_2, v_1)$. Prove that the result is the inner product on V^* giving rise to the Banach-space norm on V^* , and prove that the contragredient representation Φ^c has $\Phi^c(x)\ell_v = \ell_{\Phi(x)v}$ and is unitary in this inner product.
13. Let Φ and Φ' be two irreducible unitary representations of a compact group G on the same finite-dimensional vector space V , and suppose that they are equivalent in the sense that there is some linear invertible $E : V \rightarrow V$ with $E\Phi(g) = \Phi'(g)E$ for all $g \in G$. Prove that Φ and Φ' are unitarily equivalent in the sense that this equality for some invertible E implies this equality for some unitary E .
 14. This problem seeks to fill in the argument concerning Schur's Lemma in the example near the end of Section 8. Introduce an inner product in the space H_k of harmonic polynomials on \mathbb{R}^N homogeneous of degree k to make the representation of $O(N)$ on H_k be unitary, and let $\{h_j\}$ be an orthonormal basis. The representation Φ on H_k and its corresponding matrices $[\Phi(\rho)_{ij}]$ are given by $(\Phi(\rho)h_j)(x) = h_j(\rho^{-1}x) = \sum_i \Phi(\rho)_{ij}h_i(x)$. Let \mathcal{F} be the Fourier transform on \mathbb{R}^N , and fix a function $f(|x|)$ such that $|x|^k f(|x|)$ is in $L^2(\mathbb{R}^N)$. Define a matrix $F(|y|) = [f_{ij}(|y|)]$ for each $|y|$ by $\mathcal{F}(h_j(x)f(|x|))(y) = \sum_i h_i(y)f_{ij}(|y|)$.
 - (a) Assuming that the functions f and F are continuous functions of $|x|$, prove that $F(|y|)[\Phi(\rho)_{ij}] = [\Phi(\rho)_{ij}]F(|y|)$ for all ρ .
 - (b) Deduce from (a) and Corollary 6.27 that $\mathcal{F}(h(x)f(|x|))$ is of the form $h(y)g(|y|)$ if h is in H_k and the continuity hypothesis is satisfied.
 - (c) Show how the continuity hypothesis can be dropped in the above argument.
 15. Making use of the result of Problem 12, show that the matrix coefficients of the contragredient Φ^c of a finite-dimensional representation Φ of a compact group are the complex conjugates of those of Φ and the characters satisfy $\chi_{\Phi^c} = \overline{\chi_\Phi}$.
 16. An example in Section 8 examined the right-regular representation r of a compact group G , given by $(r(g)f)(x) = f(xg)$, and showed that the linear span of the matrix coefficients of an irreducible τ equals the whole isotypic space of type τ , a decomposition of this space into irreducible representations being given by the decomposition into rows. Show similarly for the *left-regular* representation l , given by $(l(g)f)(x) = f(g^{-1}x)$, that the linear span of the matrix coefficients of the irreducible τ equals the whole isotypic space of type τ^c , a decomposition of this space into irreducible representations being given by the decomposition into columns.
 17. Let G be a compact group, and let V be a complex Hilbert space.
 - (a) For $G = S^1$, prove that the left-regular representation l of G on $L^2(G)$ is not continuous in the operator norm topology, i.e., that $g \mapsto l(g)$ is not continuous from G into the Banach space of bounded linear operators on $L^2(G)$.

- (b) Suppose that $g \mapsto \Phi(g)$ is a homomorphism of G into unitary operators on V that is **weakly continuous**, i.e., that has the property that $g \mapsto (\Phi(g)u, v)$ is continuous for each u and v in V . Prove that $g \mapsto \Phi(g)$ is strongly continuous in the sense that $g \mapsto \Phi(g)v$ is continuous for each v in V , i.e., that Φ is a unitary representation.
18. Let G be a compact group.
- (a) Let Φ be an irreducible unitary representation of G , and let f be a linear combination of matrix coefficients of the contragredient Φ^c of Φ . Prove that $f(1) = d \operatorname{Tr} \Phi(f)$, where d is the degree of f .
- (b) Let $\{\Phi^{(\alpha)}\}$ be a maximal set of mutually inequivalent irreducible unitary representations of G , and let $d^{(\alpha)}$ be the degree of $\Phi^{(\alpha)}$. Prove that each trigonometric polynomial f on G satisfies the **Fourier inversion formula** $f(1) = \sum_{\alpha} d^{(\alpha)} \operatorname{Tr} \Phi^{(\alpha)}(f)$, the sum being a finite sum in the case of a trigonometric polynomial.
- (c) Deduce the Plancherel formula for trigonometric polynomials on G from (b).
- (d) If G is a finite group, prove that every complex-valued function on G is a trigonometric polynomial.
19. Let G be a compact group.
- (a) Prove that if h is any member of $C(G)$ such that $h(gxg^{-1}) = h(x)$ for every g and x in G , then $h * f = f * h$ for every f in $L^1(G)$.
- (b) Prove that if f is a trigonometric polynomial, then $x \mapsto \int_G f(gxg^{-1}) dg$ is a linear combination of characters of irreducible representations.
- (c) Using the Approximation Theorem, prove that any member of $C(G)$ such that $h(gxg^{-1}) = h(x)$ for every g and x in G is the uniform limit of a sequence of linear combinations of irreducible characters.
- (d) Prove that the irreducible characters form an orthonormal basis of the closed vector subspace of all members h of $L^2(G)$ satisfying $h(x) = \int_G h(gxg^{-1}) dg$ almost everywhere.
20. Let G be a finite group, let $\{\Phi^{(\alpha)}\}$ be a maximal set of inequivalent irreducible representations of G , and let $d^{(\alpha)}$ be the degree of $\Phi^{(\alpha)}$.
- (a) Prove that $\sum_{\alpha} (d^{(\alpha)})^2$ equals the number of elements in G .
- (b) Using (d) in the previous problem, prove that the number of $\Phi^{(\alpha)}$'s equals the number of conjugacy classes of G , i.e., the number of equivalence classes of G under the equivalence relation that $x \sim y$ if $x = gyg^{-1}$ for some $g \in G$.
- (c) In a symmetric group \mathfrak{S}_n , two elements are conjugate if and only if they have the same cycle structure. In \mathfrak{S}_4 , two of the irreducible representations are 1-dimensional. Using this information and the above facts, determine how many $\Phi^{(\alpha)}$'s there are for \mathfrak{S}_4 and what degrees they have.

Problems 21–22 concern Theorem 6.16, its hypotheses, and related ideas. In the theory of (separable) “Lie groups,” if S and T are closed subgroups of a Lie group G

whose intersection is discrete and the sum of whose dimensions equals the dimension of G , then multiplication $S \times T \rightarrow G$ is an open map. These problems deduce this open mapping property in a different way without any knowledge of Lie groups, and then they apply the result to give two explicit formulas for the Haar measure of $SL(2, \mathbb{R})$ in terms of measures on subgroups.

21. Let G be a separable locally compact group, and let S and T be closed subgroups such that the image of multiplication as a map $S \times T \rightarrow G$ is an open set in G . Using the result of Problem 3, prove that $S \times T \rightarrow G$ is an open map.
22. For the group $G = SL(2, \mathbb{R})$, let $K = \left\{ k_\theta = \begin{pmatrix} \cos \theta & -\sin \theta \\ \sin \theta & \cos \theta \end{pmatrix} \right\}$, $M = \{m_\pm = \pm 1\}$, $A = \left\{ a_x = \begin{pmatrix} e^x & 0 \\ 0 & e^{-x} \end{pmatrix} \right\}$, $N = \left\{ n_y = \begin{pmatrix} 1 & y \\ 0 & 1 \end{pmatrix} \right\}$, and $V = \left\{ v_t = \begin{pmatrix} 1 & 0 \\ t & 1 \end{pmatrix} \right\}$.

- (a) Prove that AN is a closed subgroup and that every element of G is uniquely the product of an element of K and an element of AN . Using Theorem 6.16, show that the formula

$$\ell(f) = \int_{\theta=0}^{2\pi} \int_{x=-\infty}^{\infty} \int_{y=-\infty}^{\infty} f(k_\theta a_x n_y) e^{2x} dy dx d\theta$$

defines a translation-invariant linear functional on $C_{\text{com}}(G)$.

- (b) Prove that MAN is a closed subgroup and that every element $\begin{pmatrix} a & b \\ c & d \end{pmatrix}$ of G with $a \neq 0$, and no other element of G , is a product of an element of V and an element of MAN . Assume that the subset of elements $\begin{pmatrix} a & b \\ c & d \end{pmatrix}$ of G with $a = 0$ has Haar measure 0. Using Theorem 6.16, show that the formula

$$\ell(f) = \sum_{m_\pm \in M} \int_{t=-\infty}^{\infty} \int_{x=-\infty}^{\infty} \int_{y=-\infty}^{\infty} f(v_t m_\pm a_x n_y) e^{2x} dy dx dv$$

defines a translation-invariant linear functional on $C_{\text{com}}(G)$.

Problems 23–27 do some analysis on the group $G = SU(2)$ of 2-by-2 unitary matrices of determinant 1. Following the notation introduced in Example 4 in Section 6 and in its continuation later in that section, let Φ_n be the representation of G on the homogeneous holomorphic polynomials of degree n in z_1 and z_2 given by $(\Phi_n(g)P) \begin{pmatrix} z_1 \\ z_2 \end{pmatrix} = P \left(g^{-1} \begin{pmatrix} z_1 \\ z_2 \end{pmatrix} \right)$. Let $T = \{t_\theta\}$, with $t_\theta = \text{diag}(e^{i\theta}, e^{-i\theta})$, be the diagonal subgroup. The text calculated that the character χ_n of Φ_n is given on T by

$$\chi_n(t_\theta) = \text{Tr } \Phi_n(t_\theta) = e^{in\theta} + e^{i(n-2)\theta} + \dots + e^{-in\theta} = \frac{e^{i(n+1)\theta} - e^{-i(n+1)\theta}}{e^{i\theta} - e^{-i\theta}}.$$

Take for granted that Φ_n is irreducible for each $n \geq 0$.

23. Take as known from linear algebra that every member of $SU(2)$ is of the form $gt_\theta g^{-1}$ for some $g \in SU(2)$ and some θ . Show that the only ambiguity in t_θ is between θ and $-\theta$. Prove that the linear mapping of $C(G)$ to $C(T)$ carrying f in $C(G)$ to the function $t_\theta \mapsto \int_G f(gt_\theta g^{-1}) dg$ has image all functions $\varphi \in C(T)$ with $\varphi(t_{-\theta}) = \varphi(t_\theta)$.

24. Reinterpret the image in the previous problem as all continuous functions on the quotient space $T/\{1, \psi\}$, where $\psi : T \rightarrow T$ interchanges $t_{-\theta}$ and t_θ . Why is this space compact Hausdorff? Why then can it be identified with $[0, \pi]$?
25. Prove that there is a Borel measure μ on $[0, \pi]$ such that

$$\int_G f(x) dx = \int_{[0, \pi]} \int_G f(gt_\theta g^{-1}) dg d\mu(\theta)$$

for all f in $C(G)$.

26. Follow these steps to identify $d\mu(\theta)$ in the previous problem and thereby have a formula for integrating over $G = SU(2)$ by first integrating over conjugacy classes. Such a formula can be obtained by computations with coordinates and use of the change-of-variables formula for multiple integrals, but the method here is shorter.
- (a) Using the orthogonality relations $\int_G \chi_n(x) \overline{\chi_0(x)} dx = \delta_{n0}$, prove that $\int_{[0, \pi]} d\mu(\theta) = 1$ and that $\int_{[0, \pi]} (e^{ik\theta} + e^{-ik\theta}) d\mu(\theta)$ is -1 for $k = 2$ but is 0 for $k = 1$ and $k \geq 3$.
- (b) Extend μ to $[-\pi, \pi]$ by setting it equal to 0 on $[-\pi, 0)$, define μ' on $[-\pi, \pi]$ by $\mu'(E) = \frac{1}{2}(\mu(E) + \mu(-E))$, observe that μ' is even, and check that $\int_{[-\pi, \pi]} \cos n\theta d\mu'(\theta)$ is equal to 1 for $n = 0$, to -1 for $n = 2$, and to 0 for $n = 1$ and $n \geq 3$.
- (c) Deduce that the periodic extension of μ' from $(-\pi, \pi]$ to \mathbb{R} is given by its Fourier–Stieltjes series $d\mu'(\theta) = \frac{1}{2\pi}(1 - \cos 2\theta) d\theta$.
- (d) (Special case of **Weyl integration formula**) Conclude that

$$\int_G f(x) dx = \frac{1}{\pi} \int_{-\pi}^{\pi} \left[\int_G f(gt_{\pm\theta} g^{-1}) dg \right] \sin^2 \theta d\theta.$$

27. Prove that every irreducible unitary representation of $SU(2)$ is equivalent to some Φ_n .

Problems 28–32 concern locally compact topological fields. Each such is of interest from the point of view of the present chapter because its additive group is a locally compact abelian group and its nonzero elements form another locally compact abelian group under multiplication. A **topological field** is a field with a Hausdorff topology such that addition, negation, multiplication, and inversion are continuous. The fields \mathbb{R} and \mathbb{C} are examples. Another example is the field \mathbb{Q}_p of p -adic numbers, where p is a prime. To construct this field, one defines on the rationals \mathbb{Q} a function $|\cdot|_p$ by setting $|0|_p = 0$ and taking $|p^n r/s|_p$ equal to p^{-n} if r and s are relatively prime integers. Then $d(x, y) = |x - y|_p$ is a metric on \mathbb{Q} , and the metric space completion is \mathbb{Q}_p . The function $|\cdot|_p$ extends continuously to \mathbb{Q}_p and is called the **p -adic norm**. It satisfies something better than the triangle inequality, namely $|x + y|_p \leq \max\{|x|_p, |y|_p\}$; this is called the **ultrametric inequality**. Problems 27–31 of Chapter II of *Basic* show that the arithmetic operations on \mathbb{Q} extend continuously to \mathbb{Q}_p and that \mathbb{Q}_p becomes a topological field such that $|xy|_p = |x|_p |y|_p$. Because of the ultrametric inequality

the subset \mathbb{Z}_p of \mathbb{Q}_p with $|x|_p \leq 1$ is a commutative ring with identity; it is called the ring of **p -adic integers**. It is a **topological ring** in that its addition, negation, and multiplication are continuous. Moreover, it is compact because every closed bounded subset of \mathbb{Q}_p can be shown to be compact. The subset I of \mathbb{Z}_p with $|x|_p \leq p^{-1}$ is the unique maximal ideal of \mathbb{Z}_p , and the quotient \mathbb{Z}_p/I is a field of p elements.

28. Prove that every compact topological field is finite.
29. Let F be a locally compact topological field, and let F^\times be the group of nonzero elements, the group operation being multiplication.
- Let c be in F^\times , and define $|c|_F$ to be the constant $a(\Phi)$ from Problem 9 when the measure is an additive Haar measure and Φ is multiplication by c . Define $|0|_F = 0$. Prove that $c \mapsto |c|_F$ is a continuous function from F into $[0, +\infty)$ such that $|c_1 c_2|_F = |c_1|_F |c_2|_F$.
 - If dx is a Haar measure for F as an additive locally compact group, prove that $dx/|x|_F$ is a Haar measure for F^\times as a multiplicative locally compact group.
 - Let $F = \mathbb{R}$ be the locally compact field of real numbers. Compute the function $x \mapsto |x|_F$. Do the same thing for the locally compact field $F = \mathbb{C}$ of complex numbers.
 - Let $F = \mathbb{Q}_p$ be the locally compact field of p -adic numbers, where p is a prime. Compute the function $x \mapsto |x|_F$.
 - For the field $F = \mathbb{Q}_p$ of p -adic numbers, suppose that the ring \mathbb{Z}_p of p -adic integers has additive Haar measure 1. What is the additive Haar measure of the maximal ideal I of \mathbb{Z}_p ?
30. Consider \mathbb{Q}_p as a locally compact abelian group under addition.
- Prove from the continuity that any multiplicative character of the additive group \mathbb{Q}_p is trivial on some subgroup $p^n \mathbb{Z}_p$ for sufficiently large n .
 - Tell how to define a multiplicative character φ_0 of the additive group \mathbb{Q}_p in such a way that φ_0 is 1 on \mathbb{Z}_p and $\varphi_0(p^{-1}) = e^{2\pi i/p}$.
 - If φ is any multiplicative character of the additive group \mathbb{Q}_p , prove that there exists a unique element k of \mathbb{Q}_p such that $\varphi(x) = \varphi_0(kx)$ for all x in \mathbb{Q}_p .
31. Let $P = \{\infty\} \cup \{\text{primes}\}$. For v in P , let \mathbb{Q}_v be the field of p -adic numbers if v is a prime p , or \mathbb{R} if $v = \infty$. For v in P , define $|\cdot|_v$ on \mathbb{Q}_v as follows: this is to be the p -adic norm on \mathbb{Q}_p if v is a prime p , and it is to be the ordinary absolute value on \mathbb{R} if $v = \infty$. Each member of the rationals \mathbb{Q} can be regarded as a member of \mathbb{Q}_v for each v in P . Prove that each rational number x has $|x|_v \neq 1$ for only finitely many v .
32. (**Artin product formula**) For each nonzero rational number x , the fact that $|x|_v \neq 1$ for only finitely many v in P shows that $\prod_v |x|_v$ is a well-defined rational number. Prove that actually $\prod_v |x|_v = 1$.

Problems 33–38 concern the ring $\mathbb{A}_{\mathbb{Q}}$ of adèles of the rationals \mathbb{Q} and the group of ideles defined in terms of it. These objects are important tools in algebraic number theory, and they provide interesting examples of locally compact abelian groups. Part of the idea behind them is to study number-theoretic questions about the integers, such as the solving of Diophantine equations or the factorization of monic polynomials with integer coefficients, by first studying congruences. One studies a congruence modulo each power of any prime, as well as any limitations imposed by treating the coefficients as real. The ring $\mathbb{A}_{\mathbb{Q}}$ of **adèles** of \mathbb{Q} is a structure that incorporates simultaneously information about all congruences modulo each prime power, together with information about \mathbb{R} . Its definition makes use of the construction of direct limits of topological spaces as in Problems 26–30 in Chapter IV, as well as the material concerning p -adic numbers in Problems 29–32 above.

33. The construction of restricted direct products in Problem 30 at the end of Chapter IV assumed that I is a nonempty index set, S_0 is a finite subset, X_i is a locally compact Hausdorff space X_i for each $i \in I$, and K_i is a compact open subset of X_i for each $i \notin S_0$. As in that problem, for each finite subset S of I containing S_0 , let

$$X(S) = \left(\prod_{i \in S} X_i \right) \times \left(\prod_{i \notin S} K_i \right),$$

giving it the product topology. Suppose that each X_i , for $i \in I$, is in fact a locally compact group and K_i , for $i \notin S_0$, is a compact open subgroup of X_i . Prove that each $X(S)$, with coordinate-by-coordinate operations, is a locally compact group and that the direct limit X acquires the structure of a locally compact group. Prove also that if each X_i is a locally compact topological ring and each K_i is a compact subring, then each $X(S)$ is a locally compact topological ring and so is the direct limit X .

34. In the construction of the previous problem, let $I = P = \{\infty\} \cup \{\text{primes}\}$ and $S_0 = \{\infty\}$, and form the restricted direct product of the various topological fields \mathbb{Q}_v for $v \in P$ with respect to the compact open subrings \mathbb{Z}_v . The above constructions lead to locally compact commutative rings $\mathbb{A}_{\mathbb{Q}}(S)$ for each finite subset S of P containing S_0 , and the direct limit $\mathbb{A}_{\mathbb{Q}}$ is the locally compact commutative topological ring of **adèles** for \mathbb{Q} . Show that each $\mathbb{A}_{\mathbb{Q}}(S)$ is an open subring of $\mathbb{A}_{\mathbb{Q}}$. Show that we can regard elements of $\mathbb{A}_{\mathbb{Q}}$ as tuples $x = (x_{\infty}, x_2, x_3, x_5, \dots, x_v, \dots) = (x_v)_{v \in P}$ in which all but finitely many coordinates x_p are in \mathbb{Z}_p .
35. For each rational number x , the fact that $|x|_v \leq 1$ for all but finitely many v allows us to regard the tuple (x, x, x, \dots) as a member of $\mathbb{A}_{\mathbb{Q}}$. Thus we may regard \mathbb{Q} , embedded “diagonally,” as a subfield of the ring $\mathbb{A}_{\mathbb{Q}}$. Prove that \mathbb{Q} is discrete, hence closed.
36. In the setting of the previous problem, prove that $\mathbb{A}_{\mathbb{Q}}/\mathbb{Q}$ is compact.

37. For the rings $\mathbb{Q}_v, \mathbb{Z}_v$, and $\mathbb{A}_{\mathbb{Q}}$, let $\mathbb{Q}_v^{\times}, \mathbb{Z}_v^{\times}$, and $\mathbb{A}_{\mathbb{Q}}^{\times}$ be the groups consisting of the members of the rings whose multiplicative inverses are in the rings. Give \mathbb{Q}_v^{\times} and \mathbb{Z}_v^{\times} the relative topology. In the case of $\mathbb{A}_{\mathbb{Q}}^{\times}$, define the topology as a restricted direct product of the locally compact groups \mathbb{Q}_v^{\times} for $v \in P$ with respect to the compact open subgroups \mathbb{Z}_v^{\times} . The locally compact group $\mathbb{A}_{\mathbb{Q}}^{\times}$ is called the group of **ideles** of \mathbb{Q} . Show that the set-theoretic inclusion of $\mathbb{A}_{\mathbb{Q}}^{\times}$ into $\mathbb{A}_{\mathbb{Q}}$ is continuous but is not a homeomorphism of $\mathbb{A}_{\mathbb{Q}}^{\times}$ with its image.
38. This problem constructs Haar measure on the ring $\mathbb{A}_{\mathbb{Q}}$ considered as an additive group. As in Problem 34, S denotes any finite subset of P containing $\{\infty\}$.
- Fix S . This part of the problem constructs Haar measure on $\mathbb{A}_{\mathbb{Q}}(S)$. For each prime p in S , define Haar measure μ_p on \mathbb{Q}_p to be normalized so that $\mu_p(\mathbb{Z}_p) = 1$. Form a measure μ_S on $\mathbb{A}_{\mathbb{Q}}(S)$ as follows: On the product $X(S)$ of \mathbb{R} and the \mathbb{Q}_p for p prime in S , use the product of Lebesgue measure and μ_p . On the product $Y(S)$ of all \mathbb{Z}_p for $p \notin S$, use the Haar measure on the infinite product of the \mathbb{Z}_p 's obtained as in Problem 8. Then $\mathbb{A}_{\mathbb{Q}}(S) = X(S) \times Y(S)$. Show that Haar measure μ_S on $\mathbb{A}_{\mathbb{Q}}(S)$ may be taken as the product of these measures on $X(S)$ and $Y(S)$ and that the resulting measures are consistent as S varies.
 - Show that each measure μ_S defines a set function on a certain σ -subalgebra $\mathcal{B}(S)$ of Borel sets of $\mathbb{A}_{\mathbb{Q}}$ that is the restriction to $\mathcal{B}(S)$ of a Haar measure on all Borel subsets of $\mathbb{A}_{\mathbb{Q}}$.
 - Show that the smallest σ -algebra for $\mathbb{A}_{\mathbb{Q}}$ containing, for every finite S containing $\{\infty\}$, the σ -algebra $\mathcal{B}(S)$ as in (b) is the σ -algebra of all Borel sets of $\mathbb{A}_{\mathbb{Q}}$.

Problems 39–47 concern almost periodic functions on topological groups. Let G be any topological group. Define a bounded continuous function $f : G \rightarrow \mathbb{C}$ to be **left almost periodic** if every sequence of left translates of f , i.e., every sequence of the form $\{g_n f\}$ with $(g_n f)(x) = f(g_n^{-1}x)$, has a uniformly convergent subsequence; equivalently the condition is that the closure in the uniform norm of the set of left translates of f is compact. Define **right almost periodic** functions similarly; it will turn out that left almost periodic and right almost periodic imply each other. Take for granted that the set of left almost periodic functions, call it $LAP(G)$, is a uniformly closed algebra stable under conjugation and containing the constants. Application of the Stone Representation Theorem (Theorem 4.15) to $LAP(G)$ produces a compact Hausdorff space S_1 , a continuous map $p : G \mapsto S_1$ with dense image, and a norm-preserving algebra isomorphism of $LAP(G)$ onto $C(S_1)$. The space S_1 is called the **Bohr compactification** of G . These problems show that S_1 has the structure of a compact group and that the map of G into S_1 is a continuous group homomorphism. Application of the Peter–Weyl Theorem to S_1 will give a Fourier analysis of $LAP(G)$ and an approximation property for its members in terms of finite-dimensional unitary representations of G .

39. Suppose that K is a compact group and that $\iota : G \rightarrow K$ is a continuous homomorphism.
- Prove that every member of $C(K)$ is left almost periodic and right almost periodic on K .
 - If F is in $C(K)$, let f be the function on G defined by $f(x) = F(\iota(x))$ for $x \in G$. Prove that f is left almost periodic and right almost periodic on G .
40. Let Φ be a finite-dimensional unitary representation of G , and let f be a matrix coefficient of Φ . Prove that f is left almost periodic and right almost periodic.
41. Let f be left almost periodic on G , let L_f be the subset of $C(G)$ consisting of the left translates of f , and let K_f be the closure in $C(G)$ of L_f . The set K_f is compact by definition of left almost periodicity.
- Prove that f is **left uniformly continuous** in the sense that for any $\epsilon > 0$, there is a neighborhood U of $\{1\}$ such that $\|gf - f\|_{\text{sup}} < \epsilon$ for all g in U .
 - Each member of the group G acts on L_f with $g_0(gf) = (g_0g)f$. Prove that this operation of g_0 on L_f is an isometry of L_f onto itself.
 - Prove that the operation of each g_0 on L_f extends uniquely to an isometry $\iota_f(g_0)$ of K_f onto itself.
42. Let X be a compact metric space with metric d , and let Γ be the group of isometries of X onto itself. Make Γ into a metric space (Γ, ρ) by defining $\rho(\varphi_1, \varphi_2) = \sup_{x \in X} d(\varphi_1(x), \varphi_2(x))$.
- Prove that Γ is compact as a metric space.
 - Prove that Γ is a topological group in this topology, hence a compact group.
 - Prove that the group action $\Gamma \times X \rightarrow X$ given by $(\gamma, x) \mapsto \gamma(x)$ is continuous.
43. Let Γ_f be the isometry group of K_f , and consider Γ_f as a compact metric space with metric as in the previous problem.
- Prove that the mapping $\iota_f : G \rightarrow \Gamma_f$ defined in Problem 41c is continuous.
 - Prove that if h is in K_f , then the definition $F_f(h)(\gamma) = (\gamma^{-1}h)(1)$ for $\gamma \in \Gamma_f$ yields a continuous function on Γ such that $h(g_0) = F_f(h)(\iota_f(g_0))$.
 - Conclude from the foregoing that f is right almost periodic and hence that left almost periodic functions can now be considered as simply **almost periodic**.
44. For each almost periodic function f on G , let $\iota_f : G \rightarrow \Gamma_f$ be the continuous homomorphism discussed in Problems 41c and 43a. Let $\Gamma = \prod_f \Gamma_f$ be the product of the compact groups Γ_f , and define $\iota(g) = \prod_f \iota_f(g)$, so that $\iota : G \rightarrow \Gamma$ is a continuous homomorphism. Problem 39b shows that if F is in $C(\Gamma)$, then the function h defined on G by $h(x) = F(\iota(x))$ is almost periodic. Prove that every almost periodic function on G arises in this way from some continuous F on this particular Γ .

45. Let K be the closure of $\iota(G)$ in the compact group Γ in the previous problem, let S_1 be the Bohr compactification of G , and let $p : G \rightarrow S_1$ be the continuous map defined by evaluations at the points of G . Prove that there is a homeomorphism $\Phi : S_1 \rightarrow K$ such that $\Phi \circ p = \iota$, so that the construction of K can be regarded as imposing a compatible group structure on the Bohr compactification of G .
46. Apply the Approximation Theorem to prove that every almost periodic function on G can be approximated uniformly by linear combinations of matrix coefficients of finite-dimensional unitary representations of G .
47. Suppose that G is abelian, and let $p : G \rightarrow K$ be the continuous homomorphism of G into its Bohr compactification. Prove that the continuous multiplicative characters of G coincide with the continuous multiplicative characters of K under an identification by p . (Educational note: It is known from “Pontryagin duality” that if the group \widehat{K} of continuous multiplicative characters of the compact abelian group K is given the discrete topology, then K is isomorphic to the compact group of multiplicative characters of \widehat{K} , the topology on this character group being the relative topology as a subset of the unit ball of the dual of $C(\widehat{K})$ in the weak-star topology. Thus K may be obtained by forming the group of continuous multiplicative characters of G , imposing the discrete topology, and forming the group of multiplicative characters of the result.)

CHAPTER VII

Aspects of Partial Differential Equations

Abstract. This chapter provides an introduction to partial differential equations, particularly linear ones, beyond the material on separation of variables in Chapter I.

Sections 1–2 give an overview. Section 1 addresses the question of how many side conditions to impose in order to get local existence and uniqueness of solutions at the same time. The Cauchy–Kovalevskaya Theorem is stated precisely for first-order systems in standard form and for single equations of order greater than one. When the system or single equation is linear with constant coefficients and entire holomorphic data, the local holomorphic solutions extend to global holomorphic solutions. Section 2 comments on some tools that are used in the subject, particularly for linear equations, and it gives some definitions and establishes notation.

Section 3 establishes the basic theorem that a constant-coefficient linear partial differential equation $Lu = f$ has local solutions, the technique being multiple Fourier series.

Section 4 proves a maximum principle for solutions of second-order linear elliptic equations $Lu = 0$ with continuous real-valued coefficients under the assumption that $L(1) = 0$.

Section 5 proves that any linear elliptic equation $Lu = f$ with constant coefficients has a “parametrix,” and it shows how to deduce from the existence of the parametrix the fact that the solutions u are as regular as the data f . The section also deduces a global existence theorem when f is compactly supported; this result uses the existence of the parametrix and the constant-coefficient version of the Cauchy–Kovalevskaya Theorem.

Section 6 gives a brief introduction to pseudodifferential operators, concentrating on what is needed to obtain a parametrix for any linear elliptic equation with smooth variable coefficients.

1. Introduction via Cauchy Data

The subject of partial differential equations is a huge and diverse one, and a short introduction necessarily requires choices. The subject has its origins in physics and nowadays has applications that include physics, differential geometry, algebraic geometry, and probability theory. A small amount of complex-variable theory will be extremely helpful, and this will be taken as known for this chapter. We shall ultimately concentrate on single equations, as opposed to systems, and on partial differential equations that are linear. After the first two sections the topics of this chapter will largely be ones that can be approached through a combination of functional analysis and Fourier analysis.

Let us for now use subscript notation for partial derivatives, as in Section I.1. A **system of p partial differential equations** in N variables for the unknown functions $u^{(1)}, \dots, u^{(m)}$ consists of p expressions

$$F_k(u^{(1)}, \dots, u^{(m)}, u_{x_1}^{(1)}, \dots, u_{x_1}^{(m)}, \dots, u_{x_N}^{(1)}, \dots, u_{x_N}^{(m)}, u_{x_1 x_1}^{(1)}, \dots, u_{x_1 x_1}^{(m)}, \dots) = 0,$$

$1 \leq k \leq p$, in an open set of \mathbb{R}^N ; it is assumed that the partial derivatives that appear as variables have bounded order. When $p = 1$, we speak of simply a **partial differential equation**. The highest order of a partial derivative that appears is the **order** of the equation or system. We might expect that it would be helpful if the number p of equations in a system equals the number m of unknown functions, but one does not insist on this condition as a matter of definition. A system in which the number p of equations equals the number m of unknown functions is said to be “determined,” but nothing is to be read into this terminology without a theorem. We shall work only with determined systems. The equation or system is **linear homogeneous** if each F_k is a linear function of its variables. It is **linear** if each F_k is the sum of a linear function and a function of the N domain variables that is taken as known.

The classical equations that we would like to include in a more general theory are the three studied in Section I.2 in connection with the method of separation of variables—the heat equation, the Laplace equation, and the wave equation—and one other, namely the Cauchy–Riemann equations. With Δ denoting the Laplacian $\Delta u = u_{x_1 x_1} + \dots + u_{x_N x_N}$, the first three of these equations in N space variables are

$$u_t = \Delta u, \quad \Delta u = 0, \quad \text{and} \quad u_{tt} = \Delta u.$$

The **Cauchy–Riemann equations** are ordinarily written as a system

$$u_x = v_y, \quad u_y = -v_x,$$

but they can be written also as a single equation if we think of u and v as real and write $f = u + iv$. Then the system is equivalent to the single equation

$$\frac{\partial f}{\partial \bar{z}} = 0 \quad \text{or} \quad f_{\bar{z}} = 0, \quad \text{where} \quad \frac{\partial}{\partial \bar{z}} = \frac{\partial}{\partial x} + i \frac{\partial}{\partial y}.$$

Guided in part by the theory of ordinary differential equations of Chapter IV in *Basic*, we shall be interested in existence-uniqueness questions for our equation or system, both local and global, and in qualitative properties of solutions, such as regularity, the propagation of singularities, and any special features. For a particular equation or system we might be interested in any of the following three problems:

- (i) to find one or more particular solutions,
- (ii) to find all solutions,
- (iii) to find those solutions meeting some initial or boundary conditions.

Problems of the third type as known as **boundary-value problems** or **initial-value problems**.¹ The method of separation of variables in Section I.2 is particularly adapted to solving this kind of problem in special situations.

For ordinary differential equations and systems these three problems are closely related, as we saw in the course of investigating existence and uniqueness in Chapter IV of *Basic*. For partial differential equations they turn out to be comparatively distinct. We can, however, use the kind of setup with first-order systems of ordinary differential equations to get an idea how much flexibility there is for the solutions to the system. Let us treat one of the variables x as distinguished² and suppose, in analogy with what happened in the case of ordinary differential equations, that the system consists of an expression for the derivative with respect to x of each of the unknown functions in terms of the variables, the unknown functions, and the other first partial derivatives of the functions. Writing down general formulas involves complicated notation that may obscure the simple things that happen; thus let us suppose concretely that the independent variables are x, y and that the unknown functions are u, v . The system is then to be

$$\begin{aligned}u_x &= F(x, y, u, v, u_y, v_y), \\v_x &= G(x, y, u, v, u_y, v_y).\end{aligned}$$

With x still regarded as special, let us suppose that u and v are known when $x = 0$, i.e., that

$$\begin{aligned}u(0, y) &= f(y), \\v(0, y) &= g(y).\end{aligned}$$

The real-variable approach of Chapter IV of *Basic* is not very transparent for this situation; an approach via power series looks much easier to apply. Thus we assume whatever smoothness is necessary, and we look for formal power series solutions in x, y . The question is then whether we can determine all the partial derivatives of all orders of u and v at a point like $(0, 0)$. It is enough to see that the system and the initial conditions determine $\frac{\partial^k u}{\partial x^k}(0, y)$ and $\frac{\partial^k v}{\partial x^k}(0, y)$ for all $k \geq 0$. For $k = 0$, the initial conditions give the values. For $k = 1$, we substitute $x = 0$ into the system itself and get values, provided we know values of all the variables at $(0, y)$. The values of u and v come from $k = 0$, and the values of u_y and v_y

¹The distinction between these terms has nothing to do with the mathematics and instead is a question of whether all variables are regarded as space variables or one variable is to be interpreted as a time variable.

²It is natural to think of this variable as representing time and to say that the differential equation and any conditions imposed at a particular value of this variable constitute an initial-value problem.

come from differentiating those expressions with respect to y . For $k = 2$, we differentiate each equation of the system with respect to x and then put $x = 0$. For each equation we get a sum of partial derivatives of F , evaluated as before, times the partial of each variable with respect to x . For the latter we need expressions for u_x, v_x, u_{xy} , and v_{xy} ; we have them since we know $u_x(0, y)$ and $v_x(0, y)$ from the step $k = 1$. This handles $k = 2$. For higher k , we can proceed inductively by continuing to differentiate the given system, but let us skip the details. The result is that the initial values of $u(0, y)$ and $v(0, y)$ are enough to determine unique formal power-series solutions satisfying those initial values.

Next, under the hypothesis that F, G, f , and g are holomorphic functions of their variables near an initial point, one can prove convergence of the resulting two-variable power series near $(0, 0)$. This fact persists when the number of equations and the number of unknown functions are increased but remain equal, and when the domain variables are arbitrary in number. The theorem is as follows.

Theorem 7.1 (Cauchy–Kovalevskaya Theorem, first form). Let a system of p partial differential equations with p unknown functions $u^{(1)}, \dots, u^{(p)}$ and N variables x_1, \dots, x_N of the form

$$\begin{aligned} u_{x_1}^{(1)} &= F_1(u^{(1)}, \dots, u^{(p)}, u_{x_2}^{(1)}, \dots, u_{x_2}^{(p)}, \dots, u_{x_N}^{(1)}, \dots, u_{x_N}^{(p)}), \\ &\vdots \\ u_{x_1}^{(p)} &= F_p(u^{(1)}, \dots, u^{(p)}, u_{x_2}^{(1)}, \dots, u_{x_2}^{(p)}, \dots, u_{x_N}^{(1)}, \dots, u_{x_N}^{(p)}), \end{aligned} \quad (*)$$

be given, subject to the initial conditions

$$\begin{aligned} u^{(1)}(0, x_2, \dots, x_N) &= f_1(x_2, \dots, x_N), \\ &\vdots \\ u^{(p)}(0, x_2, \dots, x_N) &= f_p(x_2, \dots, x_N). \end{aligned} \quad (**)$$

Suppose that f_1, \dots, f_p are holomorphic in a neighborhood in \mathbb{C}^{N-1} of the point $(x_2, \dots, x_N) = (x_2^0, \dots, x_N^0)$ and that F_1, \dots, F_p are holomorphic in a neighborhood in \mathbb{C}^{Np} of the value of the argument $u^{(1)}, \dots, u_{x_N}^{(p)}$ of the F_j 's that corresponds to $(0, x_2^0, \dots, x_N^0)$. Then there exists a neighborhood of $(x_1, x_2, \dots, x_N) = (0, x_2^0, \dots, x_N^0)$ in \mathbb{C}^N in which the system (*) has a holomorphic solution satisfying the initial conditions (**). Moreover, on any connected subneighborhood of $(0, x_2^0, \dots, x_N^0)$, there is no other holomorphic solution satisfying the initial conditions.

We omit the proof since we shall use the theorem in this generality only as a guide for how much in the way of initial conditions needs to be imposed to expect uniqueness without compromising existence. Initial conditions of the form (**) for a system of equations (*) are called **Cauchy data**.

We shall, however, make use of a special case of Theorem 7.1, where a better conclusion is available.

Theorem 7.2. In the Cauchy–Kovalevskaya system of Theorem 7.1, suppose that the functions F_k in the system (*) are of the form

$$F_k(u^{(1)}, \dots, u^{(p)}, u_{x_2}^{(1)}, \dots, u_{x_2}^{(p)}, \dots, u_{x_N}^{(1)}, \dots, u_{x_N}^{(p)}) \\ = \sum_{i=1}^p a_i u^{(i)} + \sum_{i=1}^p \sum_{j=2}^N c_{ij} u_{x_j}^{(i)} + h_k(x_1, \dots, x_N)$$

with the a_i and c_{ij} constant and with each h_j a given entire holomorphic function on \mathbb{C}^N . Suppose further that the functions $f_j(x_2, \dots, x_N)$ in the initial conditions (**) are entire holomorphic functions on \mathbb{C}^N . Then the system (*) has an entire holomorphic solution satisfying the initial conditions (**).

This theorem is proved in Problems 6–9 at the end of the chapter without making use of Theorem 7.1. We shall use it in proving Theorem 7.4 below, which in turn will be applied in Section 5.

Since our interest is really in single equations and we want to allow order > 1 , we can ask whether we can carry over to partial differential equations the familiar device for ordinary differential equations of introducing new unknown functions to change a higher-order equation to a first-order system.

Recall with an ordinary differential equation of order n for an unknown function $y(t)$ when the equation is $y^{(n)} = F(t, y, y', \dots, y^{(n-1)})$: we can introduce unknown functions y_1, \dots, y_n satisfying $y_1 = y, y_2 = y', \dots, y_n = y^{(n-1)}$, and we obtain an equivalent first-order system $y_1' = y_2, \dots, y_{n-1}' = y_n, y_n' = F(t, y_1, y_2, \dots, y_n)$. Values for $y, y', \dots, y^{(n-1)}$ at $t = t_0$ correspond to values at $t = t_0$ for y_1, y_2, \dots, y_n and give us equivalent initial-value problems.

For a single higher-order partial differential equation of order m in which the m^{th} derivative of the unknown function with respect to one of the variables x is equal to a function of everything else, the same kind of procedure changes a suitable initial-value problem into an initial-value problem for a first-order system as above. But if we ignore the initial values, the solutions of the single equation need not match the solutions of the system. Let us see what happens for a single second-order equation in two variables x, y for an unknown function u under the assumption that we have solved for u_{xx} . Thus consider the equation

$$u_{xx} = F(x, y, u, u_x, u_y, u_{xy}, u_{yy})$$

with initial data

$$\begin{aligned}u(0, y) &= f(y), \\u_x(0, y) &= g(y).\end{aligned}$$

This is another instance in which the initial data are known as **Cauchy data**: the equation has order m , and we are given the values of u and its derivatives through order $m - 1$ with respect to x at the points of the domain where $x = 0$. For this example, introduce variables u, p, q, r, s, t equal, respectively, to $u, u_x, u_y, u_{xx}, u_{xy}, u_{yy}$. With these interpretations of the variables, the given equation becomes $r = F(x, y, u, p, q, s, t)$, and we differentiate this identity to make it more convenient to use. Then u yields a solution of a system of six first-order equations, namely

$$\begin{aligned}u_x &= p, \\p_x &= r, \\q_x &= p_y, \\r_x &= F_x + pF_u + rF_p + sF_q + r_yF_s + s_yF_t, \\s_x &= r_y, \\t_x &= s_y.\end{aligned}$$

The choice here of $q_x = p_y$ rather than $q_x = s$ is important; we will not be able to invert the initial-value problem without it. The initial data will be values of u, p, q, r, s, t at $(0, y)$, and we can read off what we must use from the above values of $u(0, y)$ and $u_x(0, y)$, namely

$$\begin{aligned}u(0, y) &= f(y), \\p(0, y) &= g(y), \\q(0, y) &= f'(y), \\r(0, y) &= F(0, y, f(y), g(y), f'(y), g'(y), f''(y)), \\s(0, y) &= g'(y), \\t(0, y) &= f''(y).\end{aligned}$$

If u satisfies the initial-value problem for the single equation, then the definitions of u, p, q, r, s, t give us a solution of the initial-value problem for the system.

Let us show that a solution u, p, q, r, s, t of the initial-value problem for the system has to make u be a solution of the initial-value problem for the single equation. What needs to be shown is that $u_y = q$, $u_{xy} = s$, and $u_{yy} = t$. We use the same kind of argument with all three.

For $u_y = q$, we see from the system that $(u_y)_x = (u_x)_y = p_y = q_x$, so that $(u_y - q)_x = 0$. Therefore $u_y(x, y) - q(x, y) = h(y)$ for some function h . Setting $x = 0$ gives $h(y) = u_y(0, y) - q(0, y) = f'(y) - f'(y) = 0$. Thus $h(y) = 0$, and we obtain $u_y = q$.

Similarly for $u_{xy} = s$, we start from $u_{xxy} = p_{xy} = r_y = s_x$, so that $(u_{xy} - s)_x = 0$. Therefore $u_{xy}(x, y) - s(x, y) = k(y)$ for some function k . Setting $x = 0$ gives $k(y) = u_{xy}(0, y) - s(0, y) = p_y(0, y) - s(0, y) = g'(y) - g'(y) = 0$. Thus $k(y) = 0$, and we obtain $u_{xy} = s$.

Finally for $u_{yy} = t$, we start from $u_{xyy} = (u_{xy})_y = s_y = t_x$, so that $(u_{yy} - t)_x = 0$. Therefore $u_{yy}(x, y) - t(x, y) = l(y)$ for some function l . Setting $x = 0$ gives $l(y) = u_{yy}(0, y) - t(0, y) = f''(y) - f''(y) = 0$. Thus $l(y) = 0$, and we obtain $u_{yy} = t$.

The conclusion is that the given second-order equation with two initial conditions is equivalent to the system of six first-order equations with six initial conditions. In other words the Cauchy data for the single equation lead to Cauchy data for an equivalent first-order system. It turns out that if a single equation of order m has one unknown function and is written as solved for the m^{th} derivative of one of the variables x , and if the given Cauchy data consist of the values at $x = x_0$ of the unknown function and its derivatives through order $m - 1$, then the equation can always be converted in this way into an equivalent first-order system with given Cauchy data. The steps of the reduction to Theorem 7.1 are carried out in Problems 10–11 at the end of the chapter. The result is as follows.

Theorem 7.3 (Cauchy–Kovalevskaya Theorem, second form). Let a single partial differential equation of order m in the variables $(x, y) = (x, y_1, \dots, y_{N-1})$ of the form

$$D_x^m u = F(x, y; u; \text{all } D_x^k D_y^\alpha u \text{ with } k < m \text{ and } k + |\alpha| \leq m) \quad (*)$$

be given, subject to the initial conditions

$$D_x^i u(0, y) = f^{(i)}(y) \quad \text{for } 0 \leq i < m. \quad (**)$$

Here α is assumed to be a multi-index $\alpha = (\alpha_1, \dots, \alpha_{N-1})$ corresponding to the y variables. Suppose that $f^{(0)}, \dots, f^{(m-1)}$ are holomorphic in a neighborhood in \mathbb{C}^{N-1} of the point $(y_1, \dots, y_{N-1}) = (y_1^0, \dots, y_{N-1}^0)$ and that F is holomorphic in a neighborhood of the value of its argument corresponding to $x = 0$ and $(y_1, \dots, y_{N-1}) = (y_1^0, \dots, y_{N-1}^0)$. Then there exists a neighborhood of $(x, y_1, \dots, y_{N-1}) = (0, y_1^0, \dots, y_{N-1}^0)$ in \mathbb{C}^N in which the system $(*)$ has a holomorphic solution satisfying the initial conditions $(**)$. Moreover, on any connected subneighborhood of $(0, y_1^0, \dots, y_{N-1}^0)$, there is no other holomorphic solution satisfying the initial conditions.

In the special case that F is the sum of a known entire holomorphic function and a linear combination with constant coefficients of x , y , and the various $D_x^k D_y^\alpha u$, the steps that reduce Theorem 7.3 to Theorem 7.1 perform a reduction to Theorem 7.2. We therefore obtain a better conclusion under these hypotheses, as follows.

Theorem 7.4. Let a single partial differential equation of order m in the variables $(x, y) = (x, y_1, \dots, y_{N-1})$ of the form

$$D_x^m u = ax + b_1 y_1 + \dots + b_{N-1} y_{N-1} + \sum_{\substack{0 \leq k < m \\ k + |\alpha| \leq m}} c_{k,\alpha} D_x^k D_y^\alpha u + h(x, y_1, \dots, y_{N-1}) \quad (*)$$

be given, subject to the initial conditions

$$D_x^i u(0, y) = f^{(i)}(y) \quad \text{for } 0 \leq i < m. \quad (**)$$

Suppose that $f^{(0)}, \dots, f^{(m-1)}$ are entire holomorphic on \mathbb{C}^{N-1} and that h is entire holomorphic on \mathbb{C}^N . Then the equation (*) has an entire holomorphic solution satisfying the initial conditions (**).

The steps in the reduction of this theorem to Theorem 7.2 are indicated for $N = 2$ in Problem 11 at the end of the chapter, and the steps for general N are similar. We shall make use of Theorem 7.4 to prove the existence of certain “fundamental solutions” in Section 5.

As we said, in this reduction from an initial-value problem for a single equation to an initial-value problem for a first-order system, the equation without initial values is *not* always equivalent to the system without initial values. A simple example will suffice. In the second-order setup as above, let the given equation be $u_{xx} = -u_{yy} + 4$. That is, let $F(x, y, u, u_x, u_y, u_{xy}, u_{yy}) = -u_{yy} + 4$. This equation has $u = x^2 + y^2$ as a solution, for example. If we introduce variables u, p, q, r, s, t as above, we find that $F(x, y, u, p, q, s, t) = -t + 4$, and we obtain the system

$$\begin{aligned} u_x &= p, \\ p_x &= r, \\ q_x &= p_y, \\ r_x &= F_x + pF_u + rF_p + sF_q + r_y F_s + s_y F_t = -s_y, \\ s_x &= r_y, \\ t_x &= s_y. \end{aligned}$$

If we put

$$u = x^2, \quad p = 2x, \quad q = s = 0, \quad r = t = 2,$$

we find that this tuple (u, p, q, r, s, t) solves the system. But $u = x^2$ is not a solution of $u_{xx} = -u_{yy} + 4$.

There is a still more general Cauchy–Kovalevskaya Theorem than anything we have considered, still involving local holomorphic systems, data, and solutions. It amounts to whatever one can get by combining the Implicit Function Theorem, the technique of reduction of order via an increase in the number of equations, and Theorem 7.1. We omit the precise statement. The word “noncharacteristic” is used to describe situations in which the Implicit Function Theorem applies for this purpose.

Cauchy data are not the only kinds of initial data that one might consider. In fact, none of the examples with separation of variables in Section I.2 used Cauchy data. A typical example from that section is the Dirichlet problem for the Laplacian in the unit disk. The equation can be written as $u_{xx} = -u_{yy}$, and Cauchy data would consist of values of $u(x_0, y)$ and $u_x(x_0, y)$. This amounts to two functions on a piece of a line in the plane, and one could handle two functions of a suitable curve in the plane after applying the Implicit Function Theorem. By contrast, the Dirichlet problem requires just a single function on the unit circle for a unique solution. A more apt comparison is to think of a Sturm–Liouville problem as being an ordinary-differential-equations analog of the Dirichlet problem. A particular Sturm–Liouville problem to compare with the Dirichlet problem for the disk is the equation $u_{xx} = 0$ with boundary conditions $u(0) = u(\pi) = 0$. The region is a ball in 1-dimensional space, and the function is specified on the boundary; the function is uniquely determined without specifying the derivative on the boundary. However, if the equation is changed to $u_{xx} = -\lambda u$ for some positive constant λ , then there is a nonunique solution when λ is the square of a nonzero integer.

2. Orientation

After this essay on what is appropriate for existence and uniqueness, let us turn to some other aspects of partial differential equations and systems. A few principles and observations will influence what we do in the upcoming sections of this chapter.

The subjects of linear systems and nonlinear systems of partial differential equations cannot be completely separated.

For example let $a(x, y)$ and $b(x, y)$ be given functions on an open set in \mathbb{R}^2 , and consider the single linear equation

$$a(x, y)u_x + b(x, y)u_y = 0$$

for an unknown function $u(x, y)$. If we look for curves $c(t) = (x(t), y(t))$ along which such a function $u(x, y)$ is constant, the condition on c is that $(\frac{d}{dt})u(x(t), y(t)) = 0$, hence that

$$x'(t)u_x(x(t), y(t)) + y'(t)u_y(x(t), y(t)) = 0.$$

One way for this equation to be satisfied is that $c(t) = (x(t), y(t))$ satisfy the system

$$\begin{aligned}x'(t) &= a(x, y), \\y'(t) &= b(x, y),\end{aligned}$$

of two ordinary differential equations. This system is nonlinear, and the condition for $c(t)$ to solve it is that $c(t)$ be an integral curve. Thus u is a solution if it is constant along each integral curve. If we introduce two parameters, one varying along an integral curve and the other indexing a family of integral curves, then we obtain solutions by letting u be any function of the second parameter. Under reasonable assumptions, these solutions turn out to be the only solutions locally, and thus the solution of a certain linear partial differential equation reduces to solving a nonlinear system in fewer variables. Despite this circumstance the partial differential equations of interest to us will be the linear ones.

As we have seen, there is a distinction between the reduction of a partial differential equation to a first-order system of Cauchy type and the reduction of a Cauchy problem for the equation to the corresponding Cauchy problem for the first-order system.

One consequence is that finding a several-parameter set of solutions of a partial differential equation may not be very helpful in solving a specific boundary-value problem about the equation. With an eye on the wave equation, let us take as an example a homogeneous linear equation with constant coefficients. Let $P : \mathbb{R}^{N+1} \rightarrow \mathbb{C}$ be a polynomial such as $P(x_0, x_1, \dots, x_N) = x_0^2 - x_1^2 - \dots - x_N^2$ in the case of the wave equation, x_0 being the time variable. We write the equation in our notation with D as

$$P(D)u = 0,$$

understanding as usual that $\partial/\partial x_j$ is to be substituted in P everywhere that x_j appears. If a is any $(N + 1)$ -tuple, then $(\partial/\partial x_j)e^{a \cdot x} = a_j e^{a \cdot x}$. Consequently $P(D)e^{a \cdot x} = P(a)e^{a \cdot x}$, and $e^{a \cdot x}$ solves the equation $P(D)u = 0$ whenever $P(a) = 0$. Concretely with the wave equation, let α be a real number, let $\beta = (\beta_1, \dots, \beta_N)$ be in \mathbb{R}^N , and write $x = (t, x')$. Then $e^{\alpha t - \beta \cdot x'}$ solves the wave equation whenever $\alpha^2 = |\beta|^2$. Apart from the one constraint $\alpha^2 = |\beta|^2$, we obtain an N -parameter family of solutions of the wave equation. But this family of solutions is not of any obvious help in solving boundary-value problems such as those encountered in Section I.2. We shall discuss this example further shortly.

Global problems involving linear partial differential equations with constant coefficients lend themselves to use of the Fourier transform.

The reason is that the Fourier transform carries differentiation into multiplication by a function. Specifically under suitable conditions on f , the relevant formula is $\mathcal{F}\left(\frac{\partial f}{\partial x_j}\right)(\xi) = 2\pi i \xi_j (\mathcal{F}f)(\xi)$ if we use ξ for the Fourier transform variable.

Thus, at least on a formal level, to find a solution of an inhomogeneous equation $P(D)u = f$, we can take the Fourier transform of both sides, obtaining $P(2\pi i \xi)(\mathcal{F}u)(\xi) = (\mathcal{F}f)(\xi)$. Then we divide by $P(2\pi i \xi)$ and take the inverse Fourier transform. In Section III.1 we carried out the steps of this process for the equation $(1 - \Delta)u = f$ when f is in the Schwartz space. In this case the polynomial is $1 + 4\pi^2 |\xi|^2$, and we found that there is a solution u in the Schwartz space.

In practice the function $P(2\pi i \xi)$ may be zero in some places, and then we have to check what happens with the division. There will also be a matter of ensuring that the inverse Fourier transform is well defined where we want it to be.

In Section 3 we shall use multiple Fourier series to see that a linear equation $P(D)u = f$ with constant coefficients and with f in $C_{\text{com}}^\infty(\mathbb{R}^N)$ always has a solution in a neighborhood of a point. It is of interest also to know what happens when f is replaced by a function with fewer derivatives or even by a distribution of compact support. This matter is addressed in Problem 5 at the end of the chapter.

For a linear partial differential equation of order m , the terms with differentiations of total order m are especially important. Moreover, a linear equation with variable coefficients can sometimes be studied near a point x_0 of the domain by applying a “freezing principle.”

We explain the notion of a freezing principle in a moment. We shall now make use of the notation of Chapter V for linear differential operators L , often writing an equation under study as $Lu = f$ with f known and u unknown. Here L is given by

$$L = P(x, D) = \sum_{|\alpha| \leq m} a_\alpha(x) D^\alpha$$

for some m , or we can write

$$L = P(x, D_x) = \sum_{|\alpha| \leq m} a_\alpha(x) D_x^\alpha$$

if the variable x of differentiation needs emphasis. It is customary to assume that m is the order of L , in which case some $a_\alpha(x)$ with $|\alpha| = m$ is not identically zero.

The domain is to be an open set in real Euclidean space, usually \mathbb{R}^N ; thus x varies in that open set, and the multi-index α is an N -tuple of nonnegative integers.

The idea of a freezing principle is that the behavior of solutions of $P(x, D)u = f$ near $x = x_0$ can sometimes be studied by considering solutions of the equation $(P(x_0, D_x)u)(x) = f(x)$ and making estimates for how much effect the variability of x might have. For equations that are “elliptic” in a sense that we define shortly, the classical approach to the equations via something called “Gårding’s inequality” used this idea and worked well. We shall indicate a more recent approach via “pseudodifferential operators” in Section 6 and will omit any discussion of details concerning Gårding’s inequality in our development. The freezing principle is somewhat concealed within the mechanism of pseudodifferential operators, but it is at least visible in the notation that is used for such operators.

As far as theorems for nonelliptic operators are concerned, the idea of a freezing principle is meaningful but has its limitations. We have noted that linear differential equations with constant coefficients are at least locally solvable, a result that will be proved in Section 3. But the same is not always true for equations with variable coefficients. In 1957 Hans Lewy gave an example in \mathbb{R}^3 involving the linear differential operator

$$P(x, D) = -(D_1 + iD_2) + 2i(x_1 + ix_2)D_3.$$

For a certain function f of class C^∞ that is nowhere real analytic, the equation $P(x, D)u = f$ admits no solution in any nonempty open set. By contrast, if f is holomorphic, the Cauchy–Kovalevskaya Theorem (Theorem 7.3) ensures the existence of local solutions.

In the linear differential operator $P(x, D_x) = \sum_{|\alpha| \leq m} a_\alpha(x) D_x^\alpha$, the terms of highest order are of special interest; we group them and give them their own name:

$$P_m(x, D_x) = \sum_{|\alpha|=m} a_\alpha(x) D_x^\alpha.$$

In line with the freezing principle, when one takes a Fourier transform, one does not apply the Fourier transform to the coefficients of L , only to the various D_x^α ’s. Recalling that D_x^α goes into multiplication by $(2\pi i)^{|\alpha|} \xi^\alpha$ under the Fourier transform, we introduce the expressions³

³The Fourier transform variable ξ lies in the dual space of \mathbb{R}^N . To take maximum advantage of this fact in more advanced treatments, one wants to identify \mathbb{R}^N with the tangent space at x to the domain open set. Then ξ is to be regarded as a member of the dual of the tangent space of x , and to some extent, the formalism makes sense on smooth manifolds. We elaborate on these remarks in Chapter VIII.

$$P(x, 2\pi i\xi) = \sum_{|\alpha| \leq m} a_\alpha(x)(2\pi i\xi)^\alpha$$

and

$$P_m(x, 2\pi i\xi) = \sum_{|\alpha|=m} a_\alpha(x)(2\pi i\xi)^\alpha.$$

These are called the **symbol** and the **principal symbol** of L , respectively.

EXAMPLES. The Laplacian, the wave operator, and the heat operator have order $m = 2$, while the Cauchy–Riemann operator has $m = 1$. In all these cases except the heat operator, the symbol and the principal symbol coincide. The operators written with the notation D are

$$\begin{aligned} \Delta = \Delta_x &= D_1^2 + \cdots + D_N^2 && \text{in } \mathbb{R}^N && \text{(Laplacian),} \\ \frac{\partial}{\partial \bar{z}} &= D_1 + iD_2 && && \text{(Cauchy–Riemann operator),} \\ \square &= D_0^2 - \Delta_x && \text{in } \mathbb{R}^{N+1} && \text{(wave operator),} \\ &D_0 - \Delta_x && \text{in } \mathbb{R}^{N+1} && \text{(heat operator).} \end{aligned}$$

The principal symbols $P_m(x, 2\pi i\xi)$ in each case are independent of x and are as follows:

$$\begin{aligned} -4\pi^2(\xi_1^2 + \cdots + \xi_N^2) &&& \text{(Laplacian),} \\ 2\pi i\xi_1 - 2\pi\xi_2 &&& \text{(Cauchy–Riemann operator),} \\ -4\pi^2\xi_0^2 + 4\pi^2(\xi_1^2 + \cdots + \xi_N^2) &&& \text{(wave operator),} \\ 4\pi^2(\xi_1^2 + \cdots + \xi_N^2) &&& \text{(heat operator).} \end{aligned}$$

Complex analysis inevitably plays an important role in the study of partial differential equations.

We already saw that complex analysis is useful in addressing the Cauchy problem. The Lewy example shows that complex analysis has to play a role in drawing a distinction between linear equations with constant coefficients, where we always have local existence of solutions, and linear equations with variable coefficients, where local existence can fail if the inhomogeneous term of the equation is merely C^∞ . Actually, the complex analysis that enters the local existence theorem in Section 3 for linear equations with constant coefficients is rather primitive and can be absorbed into facts about polynomials in several variables. Complex analysis enters in a more serious way for more advanced theorems about partial differential equations, but we shall not pursue theorems that go in this direction beyond one application in Section 5 of Theorem 7.4.

Linear partial differential equations can exhibit behavior of kinds not seen in ordinary differential equations.

The operator L on an open set in \mathbb{R}^N is said to be **elliptic** at x if $P_m(x, 2\pi i\xi) = 0$ for $\xi \in \mathbb{R}^N$ only when $\xi = 0$. The operator L is **elliptic** if it is elliptic at every point x of its domain. The Laplacian and the Cauchy–Riemann operator are elliptic, but the wave operator and the heat operator are not. A linear ordinary differential operator with nonvanishing coefficient for the highest-order derivative is automatically elliptic. We shall be especially interested in elliptic operators, which are relatively easy to handle.

In Section I.2 we considered the **Dirichlet problem** for the unit disk in \mathbb{R}^2 , namely the problem of finding a function u satisfying $\Delta u = 0$ in the interior and taking prescribed values on the boundary. The problem was solved by the Poisson integral formula. No matter how rough the function on the boundary was, the solution u in the interior was a smooth function. Theorem 3.16 extended this conclusion of smoothness, showing that solutions of $\Delta u = 0$ in any open set of \mathbb{R}^N are automatically C^∞ . This behavior is typical of solutions of linear elliptic differential equations with smooth coefficients.

Other partial differential equations can behave quite differently. Consider the wave equation $((\frac{\partial}{\partial t})^2 - \Delta_x)u = 0$ with $x \in \mathbb{R}^n$. We have seen that $u(t, x) = e^{\alpha t - \beta \cdot x}$ is a solution if α is a number and β is a vector with $\alpha^2 = |\beta|^2$. But actually the exponential function is not important here. If f is any C^2 function of one variable, then $f(\alpha t - \beta \cdot x)$ is a solution as long as $\alpha^2 = |\beta|^2$ is satisfied: in fact, $((\frac{\partial}{\partial t})^2 - \Delta_x)f(\alpha t - \beta \cdot x) = f''(\alpha t - \beta \cdot x)(\alpha^2 - |\beta|^2)$. Such a solution represents an undistorted progressing wave; the roughness of the wave is maintained as time progresses. Again, this kind of behavior is not exhibited by elliptic equations.

In the special case that L is of order 2 with real coefficients and a point x_0 is specified, we can make a linear change of variables in ξ to bring the order-two terms of the operator into a certain standard form at x_0 that makes the question of ellipticity transparent. This change of variables amounts to replacing the standard basis e_1, \dots, e_N used for determining the first partial derivatives D_1, \dots, D_N by a new basis e'_1, \dots, e'_N and the corresponding first partial derivatives D'_1, \dots, D'_N . The result is as follows.

Proposition 7.5. If $L = P(x, D)$ is of order 2 and has real coefficients in an open set of \mathbb{R}^N and if a point x_0 is specified, then there exists a nonsingular N -by- N real matrix $M = [M_{ij}]$ such that the definition $D'_j = \sum_k M_{jk} D_k$ exhibits L at x_0 as of the form $\kappa_1 D_1'^2 + \dots + \kappa_N D_N'^2$ with each κ_j equal to $+1$, -1 , or 0 . The principal symbol of L at x_0 is then $-4\pi^2 \sum_j \kappa_j \xi_j'^2$, where $\xi_j' = \sum_k M_{jk} \xi_k$.

REMARKS. We see immediately that L is elliptic at x_0 if and only if all κ_j are $+1$ or all are -1 . This is the situation with the Laplacian. In Section 4 we

shall prove a maximum principle for certain elliptic operators of order 2 with real coefficients, generalizing the corresponding result for the Laplacian given in Corollary 3.20. If one κ_j is $+1$ and the others are -1 , or if one is -1 and the others are $+1$, the operator is said to be **hyperbolic** at x_0 ; this is the situation with the wave operator. Much is known about hyperbolic operators of this kind and about generalizations of them, but the study of such operators remains a continuing subject of investigation.

Lemma 7.6 (Principal Axis Theorem). If B is a real symmetric matrix, then there exist a nonsingular real matrix M and a diagonal matrix C whose diagonal entries are each $+1$, -1 , or 0 such that $B = M^{\text{tr}} C M$.

PROOF. By the finite-dimensional Spectral Theorem for self-adjoint operators, choose an orthogonal matrix P such that $P B P^{-1}$ is some real diagonal matrix E . Any real number is the product of a square and one of $+1$, -1 , and 0 , and thus $E = Q C Q$ with C as in the lemma and with $Q = Q^{\text{tr}}$ diagonal and nonsingular. Since P is orthogonal, $P^{-1} = P^{\text{tr}}$, and therefore $B = P^{\text{tr}} Q^{\text{tr}} C Q P$. This proves the lemma with $M = Q P$. \square

PROOF OF PROPOSITION 7.5. Let the principal symbol be

$$P_2(x, 2\pi i \xi) = \sum_{|\alpha|=2} a_\alpha(x) (2\pi i \xi)^\alpha = -4\pi^2 \sum_{|\alpha|=2} a_\alpha(x) \xi^\alpha.$$

We rewrite this in matrix notation, viewing $\xi = (\xi_1, \dots, \xi_N)$ as a column vector and converting $\{a_\alpha(x)\}$ into a matrix by defining

$$\begin{aligned} b_{jj}(x) &= a_\alpha(x) && \text{if } \alpha \text{ is } 2 \text{ in the } j^{\text{th}} \text{ entry and } 0 \text{ elsewhere,} \\ b_{jk}(x) &= \frac{1}{2} a_\alpha(x) && \text{if } \alpha \text{ is } 1 \text{ in the } j^{\text{th}} \text{ and } k^{\text{th}} \text{ entries and } 0 \text{ elsewhere.} \end{aligned}$$

Then $B(x) = [b_{jk}(x)]$ is a symmetric matrix, and

$$P_2(x, 2\pi i \xi) = -4\pi^2 \sum_{j,k} b_{jk}(x) \xi_j \xi_k = -4\pi^2 \xi^{\text{tr}} B(x) \xi.$$

We apply the lemma to the real symmetric matrix $B = B(x_0)$ to obtain $B(x_0) = M^{\text{tr}} C(x_0) M$ with M nonsingular and with $C(x_0)$ diagonal of the form in the lemma. Define $C(x)$ by $B(x) = M^{\text{tr}} C(x) M$, write $C(x) = [c_{jk}(x)]$ and $M = [m_{jk}]$, and put $\xi' = M \xi$. Then $P_2(x, 2\pi i \xi) = -4\pi^2 \xi^{\text{tr}} B(x) \xi = -4\pi^2 \xi'^{\text{tr}} (M^{\text{tr}} C(x) M) \xi = -4\pi^2 \xi'^{\text{tr}} C(x) \xi'$. If we set $D'_j = \sum_k M_{jk} D_k$, then the algebraic manipulations for the order-two part of L are the same as with the principal symbol and show that the order-two part of the operator is given by $P_2(x, D) = \sum_{j,k} b_{jk}(x) D_j D_k = \sum_{j,k} c_{jk}(x) D'_j D'_k$. The matrix $C(x_0)$ is diagonal with diagonal entries $+1$, -1 , and 0 , and the proposition follows. \square

Ways are needed for making routine the passage via the Fourier transform between differentiations and multiplications by polynomials.

We are going to be using the Fourier transform to transform any linear equation $Lu = f$, at least in the constant-coefficient case, into a problem involving division by a polynomial and inversion of a Fourier transform. It is inconvenient to check repeatedly the technical conditions in Proposition 8.1 of *Basic* that relate differentiations and multiplications by polynomials. Weak derivatives and Sobolev spaces as discussed in Chapter III, and distributions as discussed in Chapter V, all help us handle easily the passage via the Fourier transform between differentiations and multiplications by polynomials.

“Fundamental solutions” are useful for obtaining all solutions of a linear partial differential equation, especially for constant-coefficient equations. In the case of an elliptic equation, a substitute for a fundamental solution that is easier to find is a “parametrix,” which at least reveals qualitative properties of solutions.

In Section I.3 we encountered Green’s functions in connection with Sturm–Liouville theory. The operator L under study in that section was a second-order ordinary differential operator, and a Green’s function was the kernel of an integral operator T_1 that we used. To understand symbolically what was happening there, let us take $r = 1$ in Section I.3, and then the operator T , which is the same as the operator T_1 for $r = 1$ in that section, sets up a one-one correspondence between a class of functions u and a class of functions f , the relationship being that $u = Tf$ and $Lu = f$. In other words T was a two-sided inverse of L . The operator T was of the form $Tf(x) = \int_a^b G(x, y)f(y) dy$. If we think symbolically of taking f to be a point mass δ_{x_0} at x_0 , then we find that $T(\delta_{x_0})(x) = G(x, x_0)$, and the relationship is to be $L(G(\cdot, x_0)) = \delta_{x_0}$. In other words the Green’s function at x_0 is a **fundamental solution** u of the equation $Lu = f$ in the sense that application of L to it yields a point mass at x_0 .

These matters can easily be made rigorous with distributions of the kind introduced in Chapter V. In the case that L has constant coefficients, the notion of a fundamental solution is especially useful because the operator L commutes with translations. If a certain u produces $Lu = \delta_0$, then translation of that u by some x_0 produces a solution of $Lu = \delta_{x_0}$. In short, one obtains a fundamental solution for each point by finding it just for one point, and all solutions may be regarded as the sum of a weighted average of fundamental solutions at the various points plus a solution of $Lu = 0$. In practice we can carry out this process of weighted average by means of convolution of distributions. Corollary 5.23 carried out the details for the Laplacian in \mathbb{R}^N , once Theorem 5.22 had identified a fundamental solution at 0.

In the case of the Laplacian in all of \mathbb{R}^N , Theorem 5.22 showed that a fundamental solution at 0 is a multiple of $|x|^{-(N-2)}$ if $N > 2$. But fundamental solutions

are at best inconvenient to obtain for other equations, and a certain amount of the qualitative information they yield, at least in the elliptic case, can be obtained more easily from a “parametrix,” which is a kind of approximate fundamental solution. To illustrate matters, consider the inhomogeneous version $\Delta u = f$ of the Laplace equation, which is known as **Poisson’s equation**. Suppose that f is in $C_{\text{com}}^{\infty}(\mathbb{R}^N)$ and we seek information about a possible solution u . We shall use the Fourier transform, and therefore u had better be a function or distribution whose Fourier transform is well defined. But let us leave aside the question of what kind of function u is, going ahead with the computation. If we take the Fourier transform of both sides, we are led to ask whether the following inverse Fourier transform is meaningful:

$$-4\pi^2 \int_{\mathbb{R}^N} e^{2\pi i x \cdot \xi} |\xi|^{-2} \widehat{f}(\xi) d\xi.$$

Here $\widehat{f}(\xi)$ is in the Schwartz space, but the singularity of $|\xi|^{-2}$ at the origin does not put $|\xi|^{-2} \widehat{f}(\xi)$ into any evident space of Fourier transforms. To compensate, we use Proposition 3.5f to introduce a function $\chi \in C_{\text{com}}^{\infty}(\mathbb{R}^N)$ that is identically 0 near the origin and is identically 1 away from the origin. Then $\chi(\xi)|\xi|^{-2} \widehat{f}(\xi)$ has no singularity and is in fact in the Schwartz space. It thus makes sense to define

$$Qf(x) = -4\pi^2 \int_{\mathbb{R}^N} e^{2\pi i x \cdot \xi} \chi(\xi) |\xi|^{-2} \widehat{f}(\xi) d\xi,$$

where $Qf(x)$ is the Schwartz function with

$$\widehat{Qf}(\xi) = -4\pi^2 \chi(\xi) |\xi|^{-2} \widehat{f}(\xi).$$

Since Δf is in $C_{\text{com}}^{\infty}(\mathbb{R}^N)$ and Qf is a Schwartz function, $Q\Delta f$ and ΔQf are Schwartz functions. Applying the Fourier transform operator \mathcal{F} , as it is defined on the Schwartz space, we calculate that

$$\mathcal{F}(Q\Delta f) = \chi \widehat{f} = \mathcal{F}(\Delta Qf).$$

Hence $\mathcal{F}(Q\Delta f - f) = \mathcal{F}(\Delta Qf - f) = (\chi - 1) \widehat{f}$.

The function $\chi - 1$ on the right side is in $C_{\text{com}}^{\infty}(\mathbb{R}^N)$, and it is therefore the Fourier transform of some Schwartz function K . Since \mathcal{F} carries convolutions into products, we have $\widehat{Kf} = \widehat{K} * \widehat{f}$, and consequently

$$Q\Delta = \Delta Q = 1 + (\text{convolution by } K).$$

The operator of convolution by K is called a “smoothing operator” because, as follows from the development of Chapter V, it carries arbitrary distributions of

compact support into smooth functions. The operator Q that gives a two-sided inverse for Δ except for the smoothing term is called a **parametrix** for Δ .

The parametrix does not solve our equation for us, but it does supply useful information. As we shall see in Section 5, a parametrix will enable us to see that whenever u is a distribution solution of $\Delta u = f$ on an open set U , with f an arbitrary distribution on U , then u is smooth wherever f is smooth. In particular, any distribution solution of $\Delta u = 0$ is a smooth function. The argument will apply to any elliptic linear partial differential equation with constant coefficients. A first application of the method of pseudodifferential operators in Section 6 shows that the same conclusion is valid for any elliptic linear partial differential equation with smooth variable coefficients.

3. Local Solvability in the Constant-Coefficient Case

We come to the local existence of solutions to linear partial differential equations with constant coefficients.

Theorem 7.7. Let U be an open set in \mathbb{R}^N containing 0, and let f be in $C^\infty(U)$. If $P(D)$ is a linear differential operator with constant coefficients and with order ≥ 1 , then the equation $P(D)u = f$ has a smooth solution in a neighborhood of 0.

The proof will use multiple Fourier series as in Section III.7. Apart from that, all that we need will be some manipulations with polynomials in several variables and an integration. As in Section III.7, let us write \mathbb{Z}^N for the set of all integer N -tuples and $[-\pi, \pi]^N$ for the region of integration defining the Fourier series.

We shall give the idea of the proof, state a lemma, prove the theorem from the lemma, and then return to the proof of the lemma. The idea of the proof of Theorem 7.7 is as follows: We begin by multiplying f by a smooth function that is identically 1 near the origin and is identically 0 off some small ball containing the origin (existence of the smooth function by Proposition 3.5f), so that f is smooth of compact support, the support lying well inside $[-\pi, \pi]^N$. If we regard f as extended periodically to a smooth function, we can write $f(x) = \sum_{k \in \mathbb{Z}^N} d_k e^{ik \cdot x}$ by Proposition 3.30e. Let the unknown function u be given by $u(x) = \sum_{k \in \mathbb{Z}^N} c_k e^{ik \cdot x}$. Then $P(D)u(x)$ is given by

$$P(D)u(x) = \sum_{k \in \mathbb{Z}^N} c_k P(ik) e^{ik \cdot x},$$

and thus we want to take $c_k P(ik) = d_k$. We are done if $\frac{d_k}{P(ik)}$ decreases faster than any $|k|^{-n}$, by Proposition 3.30c and our computations. So we would like to prove that

$$|P(ik)|^{-1} \leq C(1 + |k|^2)^M \quad \text{for all } k \in \mathbb{Z}^N$$

and for some constants C and M , and then we would be done. Unfortunately this is not necessarily true; the polynomial $P(x) = |x|^2$ is a counterexample. What is true is the statement in the following lemma, and we can readily adjust the above idea to prove the theorem from this lemma.

Lemma 7.8. If $R(x)$ is any complex-valued polynomial not identically 0 on \mathbb{R}^N , then there exist $\alpha \in \mathbb{R}^N$ and constants C and M such that

$$|R(k + \alpha)|^{-1} \leq C(1 + |k|^2)^M \quad \text{for all } k \in \mathbb{Z}^N.$$

PROOF OF THEOREM 7.7. Apply the lemma to $R(x) = P(ix)$. Because of the preliminary step of multiplying f by something, we are assuming that f is smooth and has support near 0. Instead of extending f to be periodic, as suggested in the discussion before the lemma, we extend the function $f(x)e^{-i\alpha \cdot x}$ to be smooth and periodic. Thus write

$$f(x)e^{-i\alpha \cdot x} = \sum_{k \in \mathbb{Z}^N} d_k e^{ik \cdot x},$$

and put $c_k = \frac{d_k}{R(k + \alpha)}$. Since the $|d_k|$ decrease faster than $|k|^{-n}$ for any n , Lemma 7.8 and Proposition 3.30c together show that $\sum_{k \in \mathbb{Z}^N} c_k e^{ik \cdot x}$ is smooth and periodic. Define

$$u(x) = e^{i\alpha \cdot x} \sum_{k \in \mathbb{Z}^N} c_k e^{ik \cdot x} = \sum_{k \in \mathbb{Z}^N} c_k e^{i(k + \alpha) \cdot x}.$$

This function is smooth but maybe is not periodic. Application of $P(D)$ gives

$$\begin{aligned} P(D)u(x) &= \sum_{k \in \mathbb{Z}^N} c_k P(i(k + \alpha)) e^{i(k + \alpha) \cdot x} \\ &= e^{i\alpha \cdot x} \sum_{k \in \mathbb{Z}^N} \frac{d_k}{R(k + \alpha)} P(i(k + \alpha)) e^{ik \cdot x} \\ &= e^{i\alpha \cdot x} \sum_{k \in \mathbb{Z}^N} d_k e^{ik \cdot x} = e^{i\alpha \cdot x} (f(x)e^{-i\alpha \cdot x}) = f(x), \end{aligned}$$

and hence u solves the equation for the original f in a neighborhood of the origin. \square

The proof of Lemma 7.8 requires two lemmas of its own.

Lemma 7.9. For each positive integer m and positive number $\delta < \frac{1}{m}$, there exists a constant C such that

$$\int_{-1}^1 |x - c_1|^{-\delta} \cdots |x - c_m|^{-\delta} dx \leq C$$

for any m complex numbers c_1, \dots, c_m .

PROOF. For $1 \leq j \leq m$, let E_j be the subset of $[-1, 1]$ where $|x - c_j|^{-\delta}$ is the largest of the m factors in the integrand. The integral in question is then

$$\begin{aligned} &\leq \sum_{j=1}^m \int_{E_j} |x - c_1|^{-\delta} \cdots |x - c_m|^{-\delta} dx \\ &\leq \sum_{j=1}^m \int_{E_j} |x - c_j|^{-m\delta} dx \leq \sum_{j=1}^m \int_{-1}^1 |x - c_j|^{-m\delta} dx \\ &\leq \sum_{j=1}^m \int_{-1}^1 |x - \operatorname{Re} c_j|^{-m\delta} dx \leq m \sup_{r \in \mathbb{R}} \int_{-1}^1 |x - r|^{-m\delta} dx. \end{aligned}$$

On the right side the integrand decreases pointwise with $|r|$ when $|r| \geq 1$, and hence the expression is equal to

$$\begin{aligned} &m \sup_{-1 \leq r \leq 1} \int_{-1}^1 |x - r|^{-m\delta} dx \\ &= m \sup_{-1 \leq r \leq 1} \left(\int_{-1}^r (r - x)^{-m\delta} dx + \int_r^1 (x - r)^{-m\delta} dx \right) \\ &= m(1 - m\delta)^{-1} \sup_{-1 \leq r \leq 1} \left((1 + r)^{1-m\delta} + (1 - r)^{1-m\delta} \right) \\ &\leq 2^{2-m\delta} m(1 - m\delta)^{-1}. \quad \square \end{aligned}$$

Lemma 7.10. If $R(x)$ is any complex-valued polynomial on \mathbb{R}^N of degree $m > 0$, then $|R(x)|^{-\delta}$ is locally integrable whenever $\delta < \frac{1}{m}$.

PROOF. We first treat the special case that x_1^m has coefficient 1 in $R(x)$ and that integrability on the cube $[-1, 1]^N$ is to be checked. Write x' for (x_2, \dots, x_N) , so that $x = (x_1, x')$. Then $R(x) = x_1^m + \sum_{j=0}^{m-1} x_1^j p_j(x')$, where each p_j is a polynomial. For fixed x' , $R(x_1, x')$ is a monic polynomial of degree m in x_1 and factors as $(x_1 - c_1) \cdots (x_1 - c_m)$ for some complex numbers c_1, \dots, c_m depending on x' . Applying Lemma 7.9, we see that $\int_{-1}^1 |R(x_1, x')|^{-\delta} dx_1 \leq C$. Integration in the remaining $N - 1$ variables therefore gives $\int_{[-1, 1]^N} |R(x)|^{-\delta} dx \leq 2^{N-1} C$.

Turning to the general case, suppose that $R(x)$ and a point x_0 are given. We want to see that $F(x) = R(x + x_0)$ has the property that $|F(x)|^{-\delta}$ is integrable on some neighborhood of the origin in \mathbb{R}^N . The function F is still a polynomial of degree m . Let F_m be the sum of all its terms of total degree m . This cannot be identically 0 on the unit sphere since it is a nonzero homogeneous function,⁴ and thus $F_m(v_1) \neq 0$ for some unit vector v_1 . Extend $\{v_1\}$ to an orthonormal basis of \mathbb{R}^N , and define $G(y_1, \dots, y_N) = F_m(y_1 v_1 + \cdots + y_N v_N)$. The function G is a polynomial of degree m whose coefficient of y_1^m is $F_m(v_1)$ and hence is not 0, and it is obtained by applying an orthogonal transformation to the variables of F . Therefore $|G|^{-\delta}$ and $|F|^{-\delta}$ have the same integral over a ball centered at the origin. The special case shows that $|G|^{-\delta}$ is integrable over some such ball, and hence so is $|F|^{-\delta}$. \square

⁴A function F_m of several variables is **homogeneous of degree m** if $F_m(rx) = r^m F_m(x)$ for all $r > 0$ and all $x \neq 0$.

PROOF OF LEMMA 7.8. Let R have degree m , which we may assume is positive without loss of generality. The function $S(x) = |x|^{2m} R\left(\frac{x}{|x|^2}\right)$ is then a polynomial of degree $\leq 2m$, and Lemma 7.10 shows that any number δ with $\delta < \frac{1}{2m}$ has the property that $|R|^{-\delta}$ and $|S|^{-\delta}$ are integrable for $|x| \leq 1$. Using spherical coordinates and making the change of variables $r \mapsto 1/r$ in the radial direction, we see that

$$\begin{aligned} \int_{|x| \geq 1} |R(x)|^{-\delta} |x|^{-2N} dx &= \int_{r=1}^{\infty} \int_{\omega \in S^{N-1}} |R(r\omega)|^{-\delta} r^{-2N} d\omega r^{N-1} dr \\ &= \int_{r=0}^1 \int_{\omega \in S^{N-1}} |R(r^{-1}\omega)|^{-\delta} d\omega r^{N-1} dr \\ &= \int_{|x| \leq 1} |R(x/|x|^2)|^{-\delta} dx \\ &= \int_{|x| \leq 1} |S(x)|^{-\delta} |x|^{2m\delta} dx \\ &\leq \int_{|x| \leq 1} |S(x)|^{-\delta} dx. \end{aligned}$$

The right side is finite. Since $(1 + |x|^2)^{-N} \leq 1 + |x|^{-2N}$, we see that

$$\int_{\mathbb{R}^N} |R(x)|^{-\delta} (1 + |x|^2)^{-N} dx < \infty.$$

Define $E = \{\alpha \in \mathbb{R}^N \mid 0 \leq \alpha_j < 1 \text{ for all } j\}$. By complete additivity, we can rewrite the above finiteness condition as

$$\int_{\alpha \in E} \left[\sum_{k \in \mathbb{Z}^N} |R(k + \alpha)|^{-\delta} (1 + |k + \alpha|^2)^{-N} \right] d\alpha < \infty.$$

Every pair (l, β) with $l \in \mathbb{Z}$ and $\beta \in [0, 1)$ has $(l + \beta)^2 \leq 2(1 + l^2)$. Summing N such inequalities gives $|k + \alpha|^2 \leq 2N + 2|k|^2 \leq 2N(1 + |k|^2)$. Thus we obtain $1 + |k + \alpha|^2 \leq 3N(1 + |k|^2)$, $(1 + |k + \alpha|^2)^{-N} \geq (3N)^{-N} (1 + |k|^2)^{-N}$, and

$$\int_{\alpha \in E} \left[\sum_{k \in \mathbb{Z}^N} |R(k + \alpha)|^{-\delta} (1 + |k|^2)^{-N} \right] d\alpha < \infty.$$

Therefore $\sum_{k \in \mathbb{Z}^N} |R(k + \alpha)|^{-\delta} (1 + |k|^2)^{-N}$ is finite almost everywhere $[d\alpha]$. Fix an α for which the sum is finite. If

$$\sum_{k \in \mathbb{Z}^N} |R(k + \alpha)|^{-\delta} (1 + |k|^2)^{-N} = K < \infty,$$

then $|R(k + \alpha)|^{-\delta} (1 + |k|^2)^{-N} \leq K$ for all $k \in \mathbb{Z}^N$ and hence $|R(k + \alpha)|^{-1} \leq K^{1/\delta} (1 + |k|^2)^{N/\delta}$ for all $k \in \mathbb{Z}^N$. This proves Lemma 7.8. \square

4. Maximum Principle in the Elliptic Second-Order Case

In this section we work with a second-order linear homogeneous elliptic equation $Lu = 0$ with continuous real-valued coefficients in a bounded connected open subset U of \mathbb{R}^N . It will be assumed that only derivatives of u , and not u itself, appear in the equation; in other words we assume that $L(1) = 0$. The conclusion will be that a real-valued C^2 solution u cannot have an absolute maximum or an absolute minimum inside U without being constant. This result was proved already in Corollary 3.20 for the special case that L is the Laplacian Δ .

Let us use notation for L of the kind in Proposition 7.5 and its proof. Then L is of the form

$$Lu = \sum_{i,j} b_{ij}(x) D_i D_j u + \sum_k c_k(x) D_k u$$

with the matrix $[b_{ij}(x)]$ real-valued and symmetric. Ellipticity of L at x means that $\sum_{i,j} b_{ij}(x) \xi_i \xi_j \neq 0$ for $\xi \neq 0$. Thus $|\sum_{i,j} b_{ij}(x) \xi_i \xi_j|$ has a positive minimum value $\mu(x)$ on the compact set where $|\xi| = 1$. By homogeneity of $|\sum_{i,j} b_{ij}(x) \xi_i \xi_j|$ and $|\xi|^2$, we conclude that

$$\left| \sum_{i,j} b_{ij}(x) \xi_i \xi_j \right| \geq \mu(x) |\xi|^2$$

for some $\mu(x) > 0$ and all ξ . The positive number $\mu(x)$ is called the **modulus of ellipticity** of L at x .

EXAMPLE. Let L be the sum of the Laplacian and first-order terms, i.e., $Lu = \Delta u + \sum_k c_k(x) D_k u$. Suppose that u is a real-valued C^2 function on U and that u attains a local maximum at x_0 in U . By calculus, $D_i u(x_0) = 0$ for each i and $D_i^2 u(x_0) \leq 0$, so that $Lu(x_0) \leq 0$. Therefore if we know that $Lu(x)$ is > 0 everywhere in U , then u can have no local maximum in U . To obtain a maximum principle, we want to relax two conditions and still get the same conclusion. One is that we want to allow more general second-order terms in L , and the other is that we want to get a conclusion from knowing only that $Lu(x)$ is ≥ 0 everywhere. The first step is carried out in Lemma 7.11 below, and the second step will be derived from the first essentially by perturbing the situation in a subtle way.

Lemma 7.11. Let $L = \sum_{i,j} b_{ij}(x) D_i D_j + \sum_k c_k(x) D_k$, with $[b_{ij}(x)]$ symmetric, be a second-order linear elliptic operator with real-valued coefficients in an open subset U of \mathbb{R}^N such that for every x in U , there is a number $\mu(x) > 0$ such that $\sum_{i,j} b_{ij}(x) \xi_i \xi_j \geq \mu(x) |\xi|^2$ for all $\xi \in \mathbb{R}^N$. If u is a real-valued C^2 function on U such that $Lu > 0$ everywhere in U , then u has no local maximum in U .

PROOF. Suppose that u has a local maximum at x_0 . Applying Proposition 7.5, we can find a nonsingular matrix M such that the definition $D'_i = \sum_j M_{ij} D_j$ makes the second-order terms of L at x_0 take the form $\kappa_1 D_1'^2 + \cdots + \kappa_N D_N'^2$ with each κ_i equal to $+1$, -1 , or 0 . Examining the hypotheses of the lemma, we see that all κ_i must be $+1$. Hence the change of basis at x_0 via M converts the second-order terms of L into the form $D_1'^2 + \cdots + D_N'^2$. The argument in the example above is applicable at x_0 , and the lemma follows. \square

Theorem 7.12 (Hopf maximum principle). Let

$$L = \sum_{i,j} b_{ij}(x) D_i D_j + \sum_k c_k(x) D_k,$$

with $[b_{ij}(x)]$ symmetric, be a second-order linear elliptic operator with real-valued continuous coefficients in a connected open subset U of \mathbb{R}^N . If u is a real-valued C^2 function on U such that $Lu = 0$ everywhere in U , then u cannot attain its maximum or minimum values in U without being constant.

PROOF. First we normalize matters suitably. We have $|\sum_{i,j} b_{ij}(x) \xi_i \xi_j| \geq \mu(x) |\xi|^2$ with $\mu(x) > 0$ at every point. By continuity of the coefficients and connectedness of U , the expression within the absolute value signs on the left side is everywhere positive or everywhere negative. Possibly replacing L by $-L$, we shall assume that it is everywhere positive:

$$\sum_{i,j} b_{ij}(x) \xi_i \xi_j \geq \mu(x) |\xi|^2 \quad \text{for all } x \in U.$$

Because of the continuity of the coefficients of L , the coefficient functions are bounded on any compact subset of U and the function $\mu(x)$ is bounded below by a positive constant on any such compact set. Since u can always be replaced by $-u$, a result about absolute maxima is equivalent to a result about absolute minima. Thus we may suppose that u attains its absolute maximum value M at some x_1 in U , and we are to prove that u is constant in U . Arguing by contradiction, suppose that x_0 is a point in U with $u(x_0) < M$.

The idea of the proof is to use x_0 and x_1 to produce an open ball B with $B^{\text{cl}} \subseteq U$ and a point s in the boundary ∂B of B such that $u(s) = M$ and $u(x) < M$ for all x in $B^{\text{cl}} - \{s\}$. See Figure 7.1. For a suitably small open ball B_1 centered at s , we then produce a C^2 function w on \mathbb{R}^N such that $Lw > 0$ in B_1 and w attains a local maximum at the center s of B_1 . The existence of w contradicts Lemma 7.11, and thus the configuration with x_0 and x_1 could not have occurred.

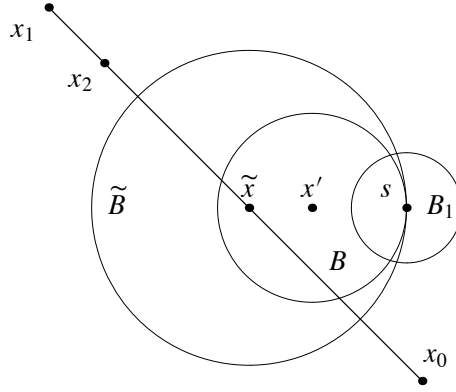

FIGURE 7.1. Construction in the proof of the Hopf maximum principle.

Since U is a connected open set in \mathbb{R}^N , it is pathwise connected. Let $p : [0, 1] \rightarrow U$ be a path with $p(0) = x_0$ and $p(1) = x_1$. Let τ be the first value of t such that $u(p(t)) = M$; necessarily $0 < \tau \leq 1$. Define $x_2 = p(\tau)$. Choose $d > 0$ such that $B(d; p(t))^{\text{cl}} \subseteq U$ for $0 \leq t \leq \tau$, and then fix a point $\tilde{x} = p(t)$ with $0 \leq t < \tau$ and with $|\tilde{x} - x_2| < \frac{1}{2}d$. By definition of d , $B(d; \tilde{x})^{\text{cl}} \subseteq U$. Let \tilde{B} be the largest open ball contained in U , centered at \tilde{x} , and having $u(x) < M$ for $x \in \tilde{B}$. Since $u(x_2) = M$ and $|\tilde{x} - x_2| < \frac{1}{2}d$, \tilde{B} has radius $< \frac{1}{2}d$. Thus $\tilde{B}^{\text{cl}} \subseteq B(d; \tilde{x})^{\text{cl}} \subseteq U$. The construction of \tilde{B} and the continuity of u force some point s of the boundary $\partial\tilde{B}$ to have $u(s) = M$. Let B be any open ball properly contained in \tilde{B} and internally tangent to \tilde{B} at s . Then $B^{\text{cl}} \subseteq \tilde{B} \cup \{s\}$, and hence $u(x) < M$ everywhere on B^{cl} except at s , where $u(s) = M$. Write $B = B(R; x')$.

To construct B_1 , fix $R_1 > 0$ with $R_1 < \frac{1}{2}R$, and let $B_1 = B(R_1; s)$. If x is in B_1^{cl} , then $|x - \tilde{x}| \leq |x - s| + |s - \tilde{x}| \leq R_1 + \frac{1}{2}d < \frac{1}{2}R + \frac{1}{2}d \leq d$, and hence $B_1^{\text{cl}} \subseteq B(d; \tilde{x})^{\text{cl}} \subseteq U$. Since B^{cl} and B_1^{cl} are compact subsets of U , the coefficients of L are bounded on $B^{\text{cl}} \cup B_1^{\text{cl}}$, and the ellipticity modulus is bounded below by a positive number. Let us say that

$$|b_{ij}(x)| \leq \beta, \quad |c_k(x)| \leq \gamma, \quad \mu(x) \geq \mu > 0 \quad \text{for } x \in B^{\text{cl}} \cup B_1^{\text{cl}}.$$

The next step is to construct an auxiliary function $z(x)$ on \mathbb{R}^N to be used in the definition of $w(x)$. Let α be a (large) positive number to be specified, and set

$$z(x) = e^{-\alpha|x-x'|^2} - e^{-\alpha R^2}.$$

The function $z(x)$ is > 0 on B , is 0 on ∂B , and is < 0 off B^{cl} . Let us see that we can choose α large enough to make $L(z)(x) > 0$ for x in B_1 . Performing the

differentiations explicitly, we obtain

$$\begin{aligned} L(z)(x) &= 2\alpha e^{-\alpha|x-x'|^2} \left(2\alpha \sum_{i,j} b_{ij}(x)(x_i - x'_i)(x_j - x'_j) \right. \\ &\quad \left. - \sum_k (b_{kk}(x) - c_k(x)(x_k - x'_k)) \right) \\ &\geq 2\alpha e^{-\alpha|x-x'|^2} (2\alpha\mu|x-x'|^2 - (\beta + \gamma|x-x'|)). \end{aligned}$$

All points x in B_1 have $\frac{1}{2}R < |x - x'| < \frac{3}{2}R$ and therefore satisfy

$$L(z)(x) \geq 2\alpha e^{-\alpha|x-x'|^2} (2\alpha\mu\frac{1}{4}R^2 - (\beta + \frac{3}{2}\gamma R)).$$

Consequently we can choose α large enough so that $L(z)(x) > 0$ for x in B_1 . Fix α with this property.

Let $\epsilon > 0$ be a (small) positive number to be specified, and define

$$w = u + \epsilon z.$$

For x in B_1 , we have $Lw = Lu + \epsilon Lz > 0$. Also,

$$w(s) = u(s) + \epsilon z(s) = u(s) = M \quad \text{since } s \text{ is in } \partial B.$$

Let us see that we can choose ϵ to make $w(x) < M$ everywhere on ∂B_1 . We consider ∂B_1 in two pieces. Let $C_0 = \partial B_1 \cap B^{\text{cl}}$. Since C_0 is a subset of $B^{\text{cl}} - \{s\}$, $u(x) < M$ at every point of C_0 . By compactness of C_0 and continuity of u , we must therefore have $u(x) \leq M - \delta$ on C_0 for some $\delta > 0$. Since the function $z(x)$ is everywhere $\leq 1 - e^{-\alpha R^2}$, any x in C_0 must have

$$w(x) = u(x) + \epsilon z(x) \leq M - \delta + \epsilon(1 - e^{-\alpha R^2}).$$

By taking ϵ small enough, we can arrange that $w(x) \leq M - \frac{1}{2}\delta$ on C_0 . Fix such an ϵ . The remaining part of ∂B_1 is $\partial B_1 - C_0$. Each x in this set has

$$w(x) = u(x) + \epsilon z(x) \leq M + \epsilon z(x) < M.$$

Thus $w(x) < M$ everywhere on ∂B_1 , as asserted.

Since $w(s) = M$ and $w(x) < M$ everywhere on ∂B_1 , w attains its maximum in B_1^{cl} somewhere in the open set B_1 . Since $Lw > 0$ on B_1 , we obtain a contradiction to Lemma 7.11. This completes the proof. \square

5. Parametrixes for Elliptic Equations with Constant Coefficients

In this section we use distribution theory to derive some results about an elliptic equation $P(D)u = f$ with constant coefficients. Initially we work on \mathbb{R}^N , yet in the end we will be able to work on any nonempty open set. We think of f as known and u as unknown. But we allow f to vary, so that we can see the effect on u of changing f . It will be important to be able to allow solutions that are not smooth functions, and thus u will be allowed to be some kind of distribution.

We begin by obtaining a parametrix, which at first will be a tempered distribution that approximately inverts $P(D)$ on $\mathcal{S}'(\mathbb{R}^N)$. More specifically it inverts $P(D)$ on $\mathcal{S}'(\mathbb{R}^N)$ up to an error term given by an operator equal to convolution with a Schwartz function.

At this point we can use the version Theorem 7.4 of the Cauchy–Kovalevskaya Theorem to obtain a **fundamental solution**, i.e., a member u of $\mathcal{D}'(\mathbb{R}^N)$ such that $P(D)u = \delta$. This step is carried out in Corollary 7.15 below. Convolution of $P(D)u = \delta$ with a member f of $\mathcal{E}'(\mathbb{R}^N)$ shows that Corollary 7.15 implies a global existence theorem: any elliptic equation $P(D)u = f$ with f in $\mathcal{E}'(\mathbb{R}^N)$ has a solution in $\mathcal{D}'(\mathbb{R}^N)$.

But it is not necessary, for purposes of examining regularity of solutions, to have an existence theorem. The next step is to modify the parametrix to have compact support. Once that has been done, the parametrix will invert $P(D)$ on $\mathcal{D}'(\mathbb{R}^N)$, up to a smoothing term, and we will deduce a regularity theorem about solutions saying that the singular support of u is contained in the singular support of f . In particular, solutions of $P(D)u = 0$ on \mathbb{R}^N are smooth. Finally we localize this result to see that the inclusion of singular supports persists even when the equation $P(D)u = f$ is being considered only on an open set U .

The starting point for our investigation is the following lemma.

Lemma 7.13. If $P(D)$ is an elliptic operator with constant coefficients, then the set of zeros of $P(2\pi i\xi)$ in \mathbb{R}^N is compact.

REMARK. The polynomial $P(2\pi i\xi)$ is the symbol of $P(D)$, as defined in Section 2. The important fact about the symbol is that the Fourier transform satisfies $\mathcal{F}(P(D)T) = P(2\pi i\xi)\mathcal{F}(T)$, which follows immediately from the formula $\mathcal{F}(D^\alpha T) = (2\pi i)^{|\alpha|}\xi^\alpha \mathcal{F}(T)$. This fact accounts for our studying the particular polynomial $P(2\pi i\xi)$.

PROOF. Let P have order m , and let Z be the set of zeros of $P(2\pi i\xi)$ in \mathbb{R}^N . Since $P(D)$ is elliptic, the principal symbol $P_m(2\pi i\xi)$ is nowhere 0 on the unit sphere of \mathbb{R}^N . By compactness of the sphere, $|P_m(2\pi i\xi)| \geq c > 0$ there, for some constant c . Taking into account the homogeneity of P_m , we see that $|P_m(2\pi i\xi)| \geq c|\xi|^m$ for all ξ in \mathbb{R}^N . If we write $P(2\pi i\xi) = P_m(2\pi i\xi) + Q(2\pi i\xi)$, then

$|Q(2\pi i\xi)| \leq C|\xi|^{m-1}$ for $|\xi| \geq 1$ and for some constant C . If ξ is in Z and $|\xi| \geq 1$, then we have $c|\xi|^m \leq P_m(2\pi i\xi) = |Q(2\pi i\xi)| \leq C|\xi|^{m-1}$, and we conclude that $|\xi| \leq C/c$. This proves the lemma. \square

Fix an elliptic operator $P(D)$, and choose $R > 0$ by the lemma such that all the zeros in \mathbb{R}^N of $P(2\pi i\xi)$ lie in the closed ball of radius R centered at the origin. Fix numbers R' and R'' with $R' > R'' > R$. Let χ be a smooth function on \mathbb{R}^N with values in $[0, 1]$ such that $\chi(\xi)$ is 0 when $|\xi| \leq R''$ and is 1 when $|\xi| \geq R'$. The formal computation is as follows: if we define v in terms of f by

$$v(x) = \int_{\mathbb{R}^N} e^{2\pi i x \cdot \xi} \frac{\mathcal{F}(f)(\xi)}{P(2\pi i\xi)} \chi(\xi) d\xi,$$

then Fourier inversion gives

$$\begin{aligned} (P(D)v)(x) &= \int_{\mathbb{R}^N} e^{2\pi i x \cdot \xi} \mathcal{F}(f)(\xi) \chi(\xi) d\xi \\ &= f(x) + \int_{\mathbb{R}^N} e^{2\pi i x \cdot \xi} (\chi(\xi) - 1) \mathcal{F}(f)(\xi) d\xi, \end{aligned}$$

and the second term on the right side will be seen to be a smoothing term. Let us now state a precise result and use properties of distributions to make this computation rigorous.

Theorem 7.14. Let $P(D)$ be an elliptic operator on \mathbb{R}^N with constant coefficients. Then there exist a distribution $k \in \mathcal{S}'(\mathbb{R}^N)$ and a Schwartz function $h \in \mathcal{F}^{-1}(C_{\text{com}}^\infty(\mathbb{R}^N))$ such that

$$P(D)k = \delta + T_h,$$

as an equality in $\mathcal{S}'(\mathbb{R}^N)$. Here δ is the Dirac distribution $\langle \delta, \varphi \rangle = \varphi(0)$. Consequently whenever f is in $\mathcal{E}'(\mathbb{R}^N)$, then the distribution $v = k * f$ is tempered and satisfies $P(D)v = f + (h * f)$.

REMARKS. The convolution operator $f \mapsto k * f$ is called a **parametrix** for $P(D)$ on $\mathcal{E}'(\mathbb{R}^N)$. More precisely it is a right parametrix, and a left parametrix can be defined similarly. The operator $f \mapsto h * f$ is called a **smoothing operator** because $h * f$ is in $C^\infty(\mathbb{R}^N)$ whenever f is in $\mathcal{E}'(\mathbb{R}^N)$. To see the smoothing property, we observe that h , as a Schwartz function, is identified with a tempered distribution when we pass to T_h . Theorem 5.21 shows that $T_h * f$ is a tempered distribution with Fourier transform $\mathcal{F}(h)\mathcal{F}(f)$. Both factors $\mathcal{F}(h)$ and $\mathcal{F}(f)$ are smooth functions, and $\mathcal{F}(h)$ has compact support. Therefore $\mathcal{F}(h * f)$ is smooth of compact support, and $h * f$ is a Schwartz function.

PROOF. The function $\sigma(\xi) = \chi(\xi)/P(2\pi i\xi)$ is smooth and is bounded on \mathbb{R}^N because, in the notation used in the proof of Lemma 7.13, $|P(2\pi i\xi)| \geq |P_m(2\pi i\xi)| - |Q(2\pi i\xi)| \geq (c|\xi| - C)|\xi|^{m-1}$ and because $(c|\xi| - C)|\xi|^{m-1} \geq 1$ as soon as $|\xi|$ is large enough. Since σ is bounded, integration of the product of σ and any Schwartz function is meaningful, and T_σ is therefore in $\mathcal{S}'(\mathbb{R}^N)$. Define $k = \mathcal{F}^{-1}(T_\sigma)$. This is in $\mathcal{S}'(\mathbb{R}^N)$ and has $\mathcal{F}(k) = T_\sigma$. Define $h = \mathcal{F}^{-1}(\chi - 1)$. Since $\chi - 1$ is in $C_{\text{com}}^\infty(\mathbb{R}^N)$, h is in $\mathcal{S}(\mathbb{R}^N)$.

Now let f in $\mathcal{E}'(\mathbb{R}^N)$ be given, and define $v = k * f$. Theorem 5.21 shows that v is in $\mathcal{S}'(\mathbb{R}^N)$ and that $\mathcal{F}(v) = \mathcal{F}(k)\mathcal{F}(f) = \sigma\mathcal{F}(f)$. Then

$$\begin{aligned} \mathcal{F}(P(D)v) &= P(2\pi i\xi)\mathcal{F}(v) = P(2\pi i\xi)\sigma(\xi)\mathcal{F}(f) \\ &= \chi(\xi)\mathcal{F}(f) = \mathcal{F}(f) + (\chi(\xi) - 1)\mathcal{F}(f) = \mathcal{F}(f) + \mathcal{F}(h)\mathcal{F}(f). \end{aligned}$$

Taking the inverse Fourier transform of both sides yields $P(D)v = f + h * f$ as asserted. For the special case $f = \delta$, we have $v = k * \delta = k$, and then $P(D)k = \delta + T_h$. This completes the proof. \square

The function h is the inverse Fourier transform of a member of $C_{\text{com}}^\infty(\mathbb{R}^N)$, specifically $h(x) = \int_{\mathbb{R}^N} e^{2\pi i x \cdot \xi} (\chi(\xi) - 1) d\xi$. Since the integration is really taking place on a compact set, we see that we can replace x by a complex variable z and obtain a holomorphic function in all of \mathbb{C}^N . In other words, h extends to a holomorphic function on \mathbb{C}^N . If we single out any variable, say x_1 , then the ellipticity of $P(D)$ implies that $D_{x_1}^m$ has nonzero coefficient in $P(D)$, and $P(D)w = h$ is therefore an equation to which the global Cauchy–Kovalevskaya Theorem applies in the form of Theorem 7.4. The theorem says that the equation $P(D)w = h$, in the presence of globally holomorphic Cauchy data, has not just a local holomorphic solution but a global holomorphic one. Therefore $P(D)w = h$ has an entire holomorphic solution w . Let us regard w and h as yielding distributions T_w and T_h on $C_{\text{com}}^\infty(\mathbb{R}^N)$, so that the equation reads $P(D)T_w = T_h$. Subtracting this from $P(D)k = \delta + T_h$ yields $P(D)(k - T_w) = \delta$. In summary we have the following corollary.

Corollary 7.15. If $P(D)$ is an elliptic operator on \mathbb{R}^N with constant coefficients, then there exists e in $\mathcal{D}'(\mathbb{R}^N)$ with $P(D)e = \delta$.

The distribution e is called a **fundamental solution** for $P(D)$ in $\mathcal{D}'(\mathbb{R}^N)$. A consequence of the existence of e is that $P(D)u = f$ has a solution u in $\mathcal{D}'(\mathbb{R}^N)$ for each f in $\mathcal{E}'(\mathbb{R}^N)$. This represents an improvement in the conclusion (fundamental solution vs. parametrix) of Theorem 7.14.

Think of Corollary 7.15 as being an existence theorem. We now turn to a discussion of the regularity of solutions. For this we do not need the existence result, and thus we shall proceed without making further use of Corollary 7.15.

Proposition 7.16. Let $P(D)$ be an elliptic operator on \mathbb{R}^N with constant coefficients. Then the tempered distribution $k = \mathcal{F}^{-1}(T_\sigma)$, where $\sigma(\xi) = \chi(\xi)/P(2\pi i\xi)$, is a smooth function on $\mathbb{R}^N - \{0\}$. Therefore, for any neighborhood of 0, the elliptic operator $P(D)$ has a parametrix $k_0 \in \mathcal{E}'(\mathbb{R}^N)$ with compact support in that neighborhood. In particular, there is a smooth function h_1 with support in that neighborhood such that whenever f is in $\mathcal{E}'(\mathbb{R}^N)$, then the distribution $v = k_0 * f$ is in $\mathcal{E}'(\mathbb{R}^N)$ and satisfies $P(D)v = f + (h_1 * f)$.

SKETCH OF PROOF. One checks that

$$D^\beta(\xi^\alpha k) = (2\pi i)^{|\beta|}(-2\pi i)^{-|\alpha|}\mathcal{F}^{-1}(T_{\xi^\beta D^\alpha \sigma}).$$

Here $\xi^\beta D^\alpha \sigma$ is a C^∞ function, and we are interested in its integrability. It is enough to consider what happens for $|\xi| \geq R'$, where $\sigma(\xi) = 1/P(2\pi i\xi)$. The function $1/P(2\pi i\xi)$ is bounded above by a multiple of $|\xi|^{-m}$, and an inductive argument on the order of the derivative shows that $|\xi^\beta D^\alpha \sigma| \leq C|\xi|^{|\beta|-|\alpha|-m}$ for $|\xi| \geq R'$, for a constant C independent of ξ .

Take $\beta = 0$. If $|\alpha|$ is large enough, we see that $D^\alpha \sigma$ is in $L^1(\mathbb{R}^N)$. Then $\mathcal{F}^{-1}(D^\alpha \sigma) = (2\pi i)^{|\alpha|}\xi^\alpha k$ is given by the usual integral formula for \mathcal{F} , but with $e^{-2\pi i x \cdot \xi}$ replaced by $e^{2\pi i x \cdot \xi}$. Therefore $\xi^\alpha k$ is a bounded continuous function when $|\alpha|$ is large enough. Applying this observation to $(\sum_{j=1}^n |\xi_j|^{2l})k$ for large enough l , we find that k is a continuous function on $\mathbb{R}^N - \{0\}$.

Next take $|\beta| = 1$ and increase l by 1, writing α' for the new α . Then $\xi^\beta D^{\alpha'} \sigma$ is integrable, and it follows⁵ that $\xi^{\alpha'} k$ has a pointwise partial derivative of type β and is continuous. Thus the same thing is true of k on $\mathbb{R}^N - \{0\}$.

Iterating this argument by adding 1 to one of the entries of β to obtain β' , we find for each β that we consider, that the functions $D^\beta(\sum_{j=1}^n |\xi_j|^{2l})k$ and $D^{\beta'}(\sum_{j=1}^n |\xi_j|^{2l'})k$ are integrable for l' sufficiently large, and we deduce that $D^\beta k$ has all first partial derivatives continuous. Since β' is arbitrary, k equals a smooth function on $\mathbb{R}^N - \{0\}$.

To finish the argument, let k and h be as in Theorem 7.14, and let ψ in $C_{\text{com}}^\infty(\mathbb{R}^N)$ be identically 1 near 0 and have support in whatever neighborhood of 0 has been specified. If we write $k = \psi k + (1 - \psi)k$, then $k_0 = \psi k$ has support in that same neighborhood, and $T = (1 - \psi)k$ is of the form T_{h_0} for some smooth function h_0 , by what we have shown. Substituting $k = k_0 + T_{h_0}$ into $P(D)k = \delta + T_h$, we find that $P(D)k_0 = \delta + T_h - T_{P(D)h_0}$. The function $h_1 = h - P(D)h_0$ is smooth, and it must have compact support since $P(D)k_0$ and δ have compact support. \square

Corollary 7.17. If u is in $\mathcal{D}'(\mathbb{R}^N)$ and $P(D)$ is elliptic, then $\text{sing supp } u \subseteq \text{sing supp } P(D)u$, where “sing supp” denotes singular support.

⁵The precise result to use is Proposition 8.1f of *Basic*.

REMARK. At first glance it might seem that the rough spots of $P(D)u$ are surely at least as bad as the rough spots of u for any D . But consider a function on \mathbb{R}^2 of the form $u(x, y) = g(y)$ and apply $P(D) = \partial/\partial x$. The result is 0, and thus $\text{sing supp } u$ can properly contain $\text{sing supp } P(D)u$ for $P(D) = \partial/\partial x$. The corollary says that this kind of thing does not happen if $P(D)$ is elliptic.

PROOF. Let $E = (\text{sing supp } P(D)u)^c$. By definition the restriction of $P(D)u$ to $C_{\text{com}}^\infty(E)$ is of the form T_ψ with ψ in $C^\infty(E)$. Let U be any nonempty open set with U^{cl} compact and with $U^{\text{cl}} \subseteq E$. It is enough to exhibit a smooth function η equal to u on U . Choose an open set V with V^{cl} compact such that $U^{\text{cl}} \subseteq V \subseteq V^{\text{cl}} \subseteq E$. Multiply ψ by a smooth function of compact support in E that equals 1 on V^{cl} , obtaining a function $\psi_0 \in C_{\text{com}}^\infty(E)$ such that $\psi_0 = \psi$ on V .

Choose an open neighborhood W of 0 such that $W = -W$ and such that the set of sums $U^{\text{cl}} + W^{\text{cl}}$ is contained in V . Applying Proposition 7.16, we can write $P(D)k_0 = \delta + h'$ with $k_0 \in \mathcal{E}'(\mathbb{R}^N)$ and $h' \in C_{\text{com}}^\infty(\mathbb{R}^N)$. The proposition allows us to insist that the support of k_0^\vee be contained in W . Then also h' has support contained in W .

We are to produce $\eta \in C^\infty(U)$ with $\langle T_\eta, \varphi \rangle = \langle u, \varphi \rangle$ for all $\varphi \in C_{\text{com}}^\infty(U)$. Our choice of W forces $k_0^\vee * \varphi$ to have support in V . Hence

$$\langle k_0 * P(D)u, \varphi \rangle = \langle P(D)u, k_0^\vee * \varphi \rangle = \langle T_\psi, k_0^\vee * \varphi \rangle = \langle T_{\psi_0}, k_0^\vee * \varphi \rangle = \langle k_0 * \psi_0, \varphi \rangle.$$

On the other hand, application of Corollary 5.14 gives

$$\langle k_0 * P(D)u, \varphi \rangle = \langle P(D)k_0 * u, \varphi \rangle = \langle (\delta + h') * u, \varphi \rangle = \langle u, \varphi \rangle + \langle h' * u, \varphi \rangle.$$

Combining the two computations, we see that $\langle u, \varphi \rangle = \langle k_0 * \psi_0 - h' * u, \varphi \rangle$, and the proof is complete if we take η to be $k_0 * \psi_0 - h' * u$. \square

The final step is to localize the result of Corollary 7.17.

Corollary 7.18. If $P(D)$ is elliptic with constant coefficients, if U is nonempty and open in \mathbb{R}^N , and if u and f are members of $\mathcal{D}'(U)$ with $P(D)u = f$, then $\text{sing supp } u \subseteq \text{sing supp } f$. Consequently if f is a smooth function on U , then so is u .

REMARKS. For the Laplacian this result gives something beyond the results in Chapter III: Part of the statement is that *any* distribution solution u of $\Delta u = 0$ on an open set U equals a smooth function on U . Previously the best result of this kind that we had was Corollary 3.17, which says that any distribution solution equal to a C^2 function is a smooth function.

PROOF. It is enough to prove that $E \cap \text{sing supp } u \subseteq E \cap \text{sing supp } f$ for each open set E with E^{cl} compact and $E^{\text{cl}} \subseteq U$. Choose ψ in $C_{\text{com}}^\infty(U)$ with ψ equal to 1 on E^{cl} . The equality $\langle \psi u, \varphi \rangle = \langle u, \psi \varphi \rangle = \langle u, \varphi \rangle$ for all $\varphi \in C_{\text{com}}^\infty(E)$ shows that $E \cap \text{sing supp } u = E \cap \text{sing supp } \psi u$. Regard ψu as in $\mathcal{E}'(\mathbb{R}^N)$, and define $g = P(D)(\psi u)$. Both ψu and g are in $\mathcal{E}'(\mathbb{R}^N)$, and every $\varphi \in C_{\text{com}}^\infty(E)$ satisfies

$$\begin{aligned} \langle g, \varphi \rangle &= \langle P(D)(\psi u), \varphi \rangle = \langle \psi u, P(D)^{\text{tr}} \varphi \rangle \\ &= \langle u, P(D)^{\text{tr}} \varphi \rangle = \langle P(D)u, \varphi \rangle = \langle f, \varphi \rangle. \end{aligned}$$

Hence $E \cap \text{sing supp } g = E \cap \text{sing supp } f$. Application of Corollary 7.17 therefore gives

$$E \cap \text{sing supp } u = E \cap \text{sing supp } \psi u \subseteq E \cap \text{sing supp } g = E \cap \text{sing supp } f,$$

and the result follows. \square

6. Method of Pseudodifferential Operators

Linear elliptic equations with variable coefficients were already well understood by the end of the 1950s. The methods to analyze them combined compactness arguments for operators between Banach spaces with the use of Sobolev spaces and similar spaces of functions. Those methods were of limited utility for other kinds of linear partial equations, but some isolated methods had been developed to handle certain cases of special interest. In the 1960s a general theory of pseudodifferential operators was introduced to include all these methods under a single umbrella, and it and its generalizations are now a standard device for studying linear partial differential equations. They provide a tool for taking advantage of point-by-point knowledge of the zero locus of the principal symbol.

As with distributions, pseudodifferential operators make certain kinds of calculations quite natural, and many verifications lie behind their use. We shall omit most of this detail and concentrate on some of the ideas behind extending the theory of the previous section to variable-coefficient operators.

We start with a nonempty open subset U of \mathbb{R}^N and a linear differential operator $P(x, D) = \sum_{|\alpha| \leq m} a_\alpha(x) D^\alpha$ whose coefficients $a_\alpha(x)$ are in $C^\infty(U)$. If u is in $C_{\text{com}}^\infty(U)$, we can regard u as in $C_{\text{com}}^\infty(\mathbb{R}^N)$. The function u is then a Schwartz function, and the Fourier inversion formula holds:

$$u(x) = \int_{\mathbb{R}^N} e^{2\pi i x \cdot \xi} \widehat{u}(\xi) d\xi,$$

where \widehat{u} is the Fourier transform $\widehat{u}(\xi) = \int_{\mathbb{R}^N} e^{-2\pi i x \cdot \xi} u(x) dx$. Applying P gives

$$\begin{aligned} P(x, D)u(x) &= \sum_{|\alpha| \leq m} a_\alpha(x) (2\pi i)^{|\alpha|} \int_{\mathbb{R}^N} e^{2\pi i x \cdot \xi} \xi^\alpha \widehat{u}(\xi) d\xi \\ &= \int_{\mathbb{R}^N} e^{2\pi i x \cdot \xi} \left(\sum_{|\alpha| \leq m} a_\alpha(x) (2\pi i)^{|\alpha|} \xi^\alpha \right) \widehat{u}(\xi) d\xi = \int_{\mathbb{R}^N} e^{2\pi i x \cdot \xi} P(x, 2\pi i \xi) \widehat{u}(\xi) d\xi, \end{aligned}$$

where $P(x, 2\pi i \xi)$ is the symbol. The basic idea of the theory is to enlarge the class of allowable symbols, thereby enlarging the class of operators under study, at least enough to include the parametrices and related operators of the previous section. The enlarged class will be the class of pseudodifferential operators.

In the constant-coefficient case, in which $P(x, 2\pi i \xi)$ reduces to $P(2\pi i \xi)$, what we did in essence was to introduce an operator of the above kind, at first with $1/P(2\pi i \xi)$ in the integrand in place of $P(2\pi i \xi)$ but then with $\chi(\xi)/P(2\pi i \xi)$ instead of $1/P(2\pi i \xi)$ in the integrand in order to eliminate the singularities. When we composed the two operators, the result was the sum of the identity and a smoothing operator.

In the variable-coefficient case, the operator we use has to be more complicated. Suppose that we want $P(x, D)G = 1 + \text{smoothing}$, with G given by the same kind of formula as $P(x, D)$ but with its symbol $g(x, \xi)$ in some wider class. If the equation in question is $P(x, D)u = f$, then our computation above shows that we want to work with $P(x, D) \left(\int_{\mathbb{R}^N} e^{2\pi i x \cdot \xi} g(x, \xi) \widehat{f}(\xi) d\xi \right)$. The effect of putting $P(x, D)$ under the integral sign is not achieved by including $P(x, 2\pi i \xi)$ in the integrand, because the product $e^{2\pi i x \cdot \xi} g(x, \xi)$ is being differentiated. A brief formal computation shows that $D^\alpha (e^{2\pi i x \cdot \xi} g(x, \xi)) = e^{2\pi i x \cdot \xi} ((D_x + 2\pi i \xi)^\alpha g(x, \xi))$, where the subscript x is included on D_x to emphasize that the differentiation is with respect to x . Thus we want $P(x, D_x + 2\pi i \xi)g(x, \xi)$ to be close to identically 1, differing by the symbol of a "smoothing operator." We cannot simply divide by $P(x, D_x + 2\pi i \xi)$ because of the presence of the D_x . What we can do is expand in terms of degrees of homogeneity in ξ and sort everything out. When degrees of homogeneity are counted, ξ^α has degree $|\alpha|$ while D_x has degree 0. Expansion of P gives

$$P(x, D_x + 2\pi i \xi) = P_m(x, 2\pi i \xi) + \sum_{j=0}^{m-1} p_j(x, \xi, D_x),$$

where P_m is the principal symbol and p_j is homogeneous in ξ of degree j . No D_x is present in P_m because degree m in ξ can occur only from terms $(2\pi i \xi)^\alpha$ in $(D_x + 2\pi i \xi)^\alpha$. Since the constant function of ξ has homogeneity degree 0 and

since degrees of homogeneity add, let us look for an expansion of $g(x, \xi)$ in the form

$$g(x, \xi) = \sum_{j=0}^{\infty} g_j(x, \xi),$$

with g_j homogeneous in ξ of degree $-m - j$. Expanding the product

$$(P_m(x, 2\pi i\xi) + \sum_{k=0}^{m-1} p_k(x, \xi, D_x)) \left(\sum_{j=0}^{\infty} g_j(x, \xi) \right) = 1$$

and collecting terms by degree of homogeneity, we read off equations

$$\begin{aligned} P_m(x, 2\pi i\xi)g_0(x, \xi) &= 1, \\ P_m(x, 2\pi i\xi)g_1(x, \xi) + p_{m-1}(x, \xi, D_x)g_0(x, \xi) &= 0, \\ P_m(x, 2\pi i\xi)g_2(x, \xi) + p_{m-1}(x, \xi, D_x)g_1(x, \xi) + p_{m-2}(x, \xi, D_x)g_0(x, \xi) &= 0, \end{aligned}$$

and so on. Dividing each equation by $P_m(x, 2\pi i\xi)$, we obtain recursive formulas for the $g_j(x, \xi)$'s, except for the problem that $P_m(x, 2\pi i\xi)$ vanishes for $\xi = 0$. To handle this vanishing, we again have to introduce a function like $\chi(\xi)$ by which to multiply g_j , and it turns out that in order to produce convergence, χ has to be allowed to depend on j . After the g_j 's have been adjusted, we need to assemble an adjusted g from them and form a **right parametrix**, namely the pseudodifferential operator G corresponding to symbol $g(x, \xi)$ such that $P(x, D)G = 1 + R$, where R is a "smoothing operator."

To make all this at all precise, we need to be more specific about a class of symbols, about the definition of the corresponding pseudodifferential operators, about the recognition of "smoothing operators," and about the assembly of the symbol from the sequence of homogeneous terms.

Fix a nonempty open set U in \mathbb{R}^N , and fix a real number m , not necessarily an integer. The symbol class known as $S_{1,0}^m(U)$ and called the class of **standard symbols** of order m consists of the set of all functions g in $C^\infty(U \times \mathbb{R}^N)$ such that for each compact set $K \subseteq U$ and each pair of multi-indices α and β , there exists a constant $C_{K,\alpha,\beta}$ with⁶

$$|D_\xi^\alpha D_x^\beta g(x, \xi)| \leq C_{K,\alpha,\beta} (1 + |\xi|)^{m-|\alpha|} \quad \text{for } x \in K, \xi \in \mathbb{R}^N.$$

Then $D_\xi^\alpha D_x^\beta g$ will be a symbol in the class $S_{1,0}^{m-|\alpha|}(U)$. Let $S_{1,0}^{-\infty}(U)$ be the intersection of all $S_{1,0}^{-n}(U)$ for $n \geq 0$.

⁶The symbol class $S_{1,0}^m(U)$ is not the historically first class of symbols to have been studied, but it has come to be the usual one. Classes $S_{\rho,\delta}^m(U)$ occur frequently as well, but we shall not discuss them.

EXAMPLES.

(1) If $P(x, D) = \sum_{|\alpha| \leq m} a_\alpha D^\alpha$ with all a_α in $C^\infty(U)$, then its symbol $P(x, 2\pi i\xi) = \sum_{|\alpha| \leq m} a_\alpha(x)(2\pi i)^{|\alpha|} \xi^\alpha$ is in $S_{1,0}^m(U)$.

(2) If $P(x, D)$ in Example 1 is elliptic, then the parametrix $g(x, \xi)$ that we construct will be in $S_{1,0}^{-m}(U)$.

(3) With P and g formed as in Examples 1 and 2, the error term $r(x, \xi)$ such that $P(x, D_x + 2\pi i\xi)g(x, \xi) = 1 + r(x, \xi)$ will be in $S_{1,0}^{-\infty}(U)$. The corresponding pseudodifferential operator will be a “smoothing operator” in a sense to be defined below.

To a standard symbol g , we associate a **pseudodifferential operator** $G = G(x, D)$ first on smooth functions and then on distributions.⁷ The associated $G : C_{\text{com}}^\infty(U) \rightarrow C^\infty(U)$ for a symbol $g \in S_{1,0}^m(U)$ is given by

$$(G\varphi)(x) = \int_{\mathbb{R}^N} e^{2\pi i x \cdot \xi} g(x, \xi) \widehat{\varphi}(\xi) d\xi \quad \text{for } \varphi \in C_{\text{com}}^\infty(U), x \in U.$$

One readily checks that $G\varphi$ is indeed in $C^\infty(U)$ and that $G : C_{\text{com}}^\infty(U) \rightarrow C^\infty(U)$ is continuous. The associated $G : \mathcal{E}'(U) \rightarrow \mathcal{D}'(U)$ is given by⁸

$$\langle Gf, \varphi \rangle = \int_{\mathbb{R}^N} \left[\int_U e^{2\pi i x \cdot \xi} g(x, \xi) \varphi(x) dx \right] \mathcal{F}(f)(\xi) d\xi \quad \text{for } f \in \mathcal{E}'(U).$$

(Recall that $\mathcal{F}(f)$ is a smooth function, according to Theorem 5.20.) One readily checks that $\langle Gf, \varphi \rangle$ is well defined, that Gf is in $\mathcal{D}'(U)$, and that when $f = T_\psi$ for some $\psi \in C_{\text{com}}^\infty(U)$, then $G(T_\psi) = T_{G\psi}$.

The error term in constructing a parametrix is ultimately handled by the following fact: if g is a symbol in $S_{1,0}^{-\infty}(U)$, then G carries $\mathcal{E}'(U)$ into $C^\infty(U)$. For this reason the pseudodifferential operators with symbol in $S_{1,0}^{-\infty}(U)$ are called **smoothing operators**.

With the definitions made, let us return to the construction of a right parametrix for the elliptic differential operator $P(x, D)$. Let us write $p_m(x, \xi, D_x)$ for the principal symbol $P_m(x, 2\pi i\xi)$ in order to make the notation uniform. The

⁷Pseudodifferential operators can be used with other domains, such as Sobolev spaces, in order to obtain additional quantitative information. But we shall not pursue such lines of investigation here. Further comments about this matter occur in Section VIII.8.

⁸Our standard procedure for defining operations on distributions has consistently been to define the operation on smooth functions, to exhibit an explicit formula for the transpose operator on smooth functions and observe that the transpose is continuous, and to use the transpose operator to define the operator on distributions. This procedure avoids the introduction of topologies on spaces of distributions. In the present discussion of the operation of a pseudodifferential operator on distributions, we defer the introduction of transpose to Section VIII.6.

recursive computation given above produces expressions $g_j(x, \xi)$ for $j \geq 0$ such that

$$\left(\sum_{k=0}^m p_k(x, \xi, D_x)\right)\left(\sum_{j=0}^{\infty} g_j(x, \xi)\right) = 1$$

in a formal sense. The actual $g_j(x, \xi)$'s are not standard symbols because the formula for $g_j(x, \xi)$ involves division by $(p_m(x, \xi))^{j+1}$ and because $p_m(x, \xi)$ vanishes at $\xi = 0$. However, the product $\chi_j(\xi)g_j(x, \xi)$ is a standard symbol if χ_j is a smooth function identically 0 near $\xi = 0$ and identically 1 off some compact set. Thus we attempt to form the sum

$$g(x, \xi) = \sum_{j=0}^{\infty} \chi_j(\xi)g_j(x, \xi)$$

and use it as parametrix. Again we encounter a problem: we find that convergence is not automatic. More care is needed. What works is to define $\chi_j(\xi) = \chi(R_j^{-1}|\xi|)$, where $\chi : \mathbb{R} \rightarrow [0, 1]$ is a smooth function that is 0 for $|t| \leq \frac{1}{2}$ and is 1 for $|t| \geq 1$. One shows that positive numbers R_j tending to infinity can be constructed so that the partial sums in the series for $g(x, \xi)$ converge in $C^\infty(U \times \mathbb{R}^N)$ and the result is in the symbol class $S_{1,0}^{-m}(U)$. Let G be the pseudodifferential operator corresponding to $g(x, \xi)$.

A little computation shows that

$$P(x, D_x + \xi)g(x, \xi) = 1 + r(x, \xi),$$

where
$$r(x, \xi) = -1 + \chi_0(\xi) - \sum_{j=1}^{\infty} r_j(x, \xi)$$

and
$$r_j(x, \xi) = \sum_{k=1}^{\min\{j,m\}} [\chi_{j-k}(\xi) - \chi_j(\xi)]p_{m-k}(x, \xi, D_x)g_{j-k}(x, \xi).$$

The function $r_j(x, \xi)$ is in $C^\infty(U \times \mathbb{R}^N)$ and vanishes for $|\xi| > R_j$. This fact, the identities already established, and the construction of the numbers R_j allow one to see that $\sum_{j=n+1}^{\infty} r_j(x, \xi)$ is in $S_{1,0}^{-n}(U)$. Since the remaining finite number of terms of $r(x, \xi)$ have compact support in ξ , they too are in $S_{1,0}^{-n}(U)$ and then so is $r(x, \xi)$. Since n is arbitrary, $r(x, \xi)$ is in $S_{1,0}^{-\infty}(U)$. Hence the corresponding pseudodifferential operator is a smoothing operator. Consequently we obtain, as an identity on $C_{\text{com}}^\infty(U)$ or on $\mathcal{E}'(U)$,

$$P(x, D)G = 1 + R$$

with R a smoothing operator. Therefore G is a right parametrix for $P(x, D)$.

From the existence of a *right* parametrix, it can be shown that $P(x, D)u = f$ is locally solvable.⁹ If we could obtain a **left parametrix**, i.e., a pseudodifferential operator H with $HP(x, D) = 1 + S$ for a smoothing operator S , then it would follow that singular supports satisfy

$$\text{sing supp } u = \text{sing supp } f \quad \text{whenever } f \text{ is in } \mathcal{E}'(U) \text{ and } P(x, D)u = f.$$

Inclusion in one direction follows from the local nature of $P(x, D)$ in its action on u : $\text{sing supp } f = \text{sing supp } P(x, D)u \subseteq \text{sing supp } u$. Inclusion in the reverse direction uses the “pseudolocal” property of any pseudodifferential operator and of H in particular, namely that $\text{sing supp } Hf \subseteq \text{sing supp } f$. It goes as follows:

$$\begin{aligned} \text{sing supp } u &= \text{sing supp } (1 + S)u = \text{sing supp } HP(x, D)u \\ &= \text{sing supp } Hf \subseteq \text{sing supp } f. \end{aligned}$$

In particular, if f is in $C_{\text{com}}^\infty(U)$, then u is in $C^\infty(U)$. Constructing a left parametrix H with the techniques discussed so far is, however, more difficult than constructing the right parametrix G because we cannot so readily determine the symbol of $HP(x, D)$ for a general pseudodifferential operator H .

Let us again work with the general theory, taking g to be in $S_{1,0}^m(U)$ and denoting the corresponding pseudodifferential operator $G : C_{\text{com}}^\infty(U) \rightarrow C^\infty(U)$ by

$$(G\varphi)(x) = \int_{\mathbb{R}^N} e^{2\pi i x \cdot \xi} g(x, \xi) \widehat{\varphi}(\xi) d\xi \quad \text{for } \varphi \in C_{\text{com}}^\infty(U).$$

The distribution $T_{G\varphi}$, which we write more simply as $G\varphi$, acts on a function ψ in $C_{\text{com}}^\infty(U)$ by

$$\begin{aligned} \langle G\varphi, \psi \rangle &= \int_{\mathbb{R}^N} \int_U e^{2\pi i x \cdot \xi} g(x, \xi) \psi(x) \widehat{\varphi}(\xi) dx d\xi \\ &= \int_{\mathbb{R}^N} \int_U \int_U e^{2\pi i(x-y) \cdot \xi} g(x, \xi) \psi(x) \varphi(y) dy dx d\xi. \end{aligned}$$

If we think of $\psi(x)\varphi(y)$ as a particular kind of function $w(x, y)$ in $C_{\text{com}}^\infty(U \times U)$, then we can extend the above formula to define a linear functional \mathcal{G} on all of $C_{\text{com}}^\infty(U \times U)$ by

$$\langle \mathcal{G}, w \rangle = \int_{\mathbb{R}^N} \left[\int_{U \times U} e^{2\pi i(x-y) \cdot \xi} g(x, \xi) w(x, y) dx dy \right] d\xi.$$

It is readily verified that \mathcal{G} is continuous on $C_{\text{com}}^\infty(U \times U)$ and hence lies in $\mathcal{D}'(U \times U)$. The expression written formally as

$$\mathcal{G}(x, y) = \int_{\mathbb{R}^N} e^{2\pi i(x-y) \cdot \xi} g(x, \xi) d\xi$$

is called the **distribution kernel** of the pseudodifferential operator G . This expression is not to be regarded as a function but as a distribution that is evaluated by the formula for $\langle \mathcal{G}, w \rangle$ above.

The first serious general fact in the theory is as follows.

⁹More detail about this matter is included in Section VIII.8.

Theorem 7.19. If G is a pseudodifferential operator on an open set U in \mathbb{R}^N , then the distribution kernel \mathcal{G} of G is a smooth function off the diagonal of $U \times U$, and G is **pseudolocal** in the sense that

$$\text{sing supp } Gf \subseteq \text{sing supp } f \quad \text{for all } f \in \mathcal{E}'(U).$$

We give only a few comments about the proof, omitting all details. The first conclusion of the theorem is proved by using the known decrease of the derivatives of $g(x, \xi)$. For example, to see that \mathcal{G} is given by a continuous function, one uses the decrease of $D_\xi^\alpha g(x, \xi)$ in the ξ variable to exhibit $(x - y)^\alpha \mathcal{G}$, for $|\alpha| > m + N$, as equal to a multiple of the continuous function $\int_{\mathbb{R}^N} e^{2\pi i(x-y)\cdot\xi} D_\xi^\alpha g(x, \xi) d\xi$. The second conclusion of the theorem, the pseudolocal property, can be derived as a consequence by using an approximate-identity argument.

To establish a general theory of pseudodifferential operators, the next step is to come to grips with the composition of two pseudodifferential operators. If we have two pseudodifferential operators G and H on the open set U , then each maps $C_{\text{com}}^\infty(U)$ into $C^\infty(U)$, and their composition $G \circ H$ need not be defined. But the composition is sometimes defined, as in the case that H is a differential operator and in the case that H is replaced by $\psi(x)H$, where ψ is a fixed member of $C_{\text{com}}^\infty(U)$. Thus let us for the moment ignore this problem concerning the image of H and make a formal calculation of the symbol of the composition anyway. Say that $G = G(x, D)$ and $H = H(x, D)$ are defined by the symbols $g(x, \xi)$ and $h(x, \xi)$. Substituting from the definition of $H(x, D)\varphi(x)$ and allowing any interchanges of limits that present themselves, we have

$$\begin{aligned} G(x, D)H(x, D)\varphi(x) &= G(x, D) \int_{\mathbb{R}^N} e^{2\pi i x \cdot \xi} h(x, \xi) \widehat{\varphi}(\xi) d\xi \\ &= \int_{\mathbb{R}^N} G(x, D_x) [e^{2\pi i x \cdot \xi} h(x, \xi)] \widehat{\varphi}(\xi) d\xi \\ &= \int_{\mathbb{R}^N} e^{2\pi i x \cdot \xi} (e^{-2\pi i x \cdot \xi} G(x, D_x) [e^{2\pi i x \cdot \xi} h(x, \xi)]) \widehat{\varphi}(\xi) d\xi. \end{aligned}$$

This formula suggests that the composition $J = G \circ H$ ought to be a pseudodifferential operator with symbol

$$\begin{aligned} j(x, \xi) &= e^{-2\pi i x \cdot \xi} G(x, D_x) [e^{2\pi i x \cdot \xi} h(x, \xi)] \\ &= e^{-2\pi i x \cdot \xi} \int_{\mathbb{R}^N} e^{2\pi i x \cdot \eta} g(x, \eta) [e^{2\pi i x \cdot \xi} h(x, \xi)] \widehat{(\cdot)}(\eta) d\eta. \end{aligned}$$

Let us suppose that the Fourier transform of $h(x, \xi)$ in the first variable is meaningful, as it is when $h(\cdot, \xi)$ has compact support. Write $\widehat{h}(\cdot, \xi)$ for this Fourier transform. Then the above expression is equal to

$$\int_{\mathbb{R}^N} e^{2\pi i x \cdot (\eta - \xi)} g(x, \eta) \widehat{h}(\eta - \xi, \xi) d\eta = \int_{\mathbb{R}^N} e^{2\pi i x \cdot \eta} g(x, \eta + \xi) \widehat{h}(\eta, \xi) d\eta.$$

If we form the infinite Taylor series expansion of $g(x, \eta + \xi)$ about $\eta = 0$ and assume that it converges, we have

$$g(x, \eta + \xi) = \sum_{\alpha} \frac{1}{\alpha!} D_{\xi}^{\alpha} g(x, \xi) \eta^{\alpha}.$$

Substituting and interchanging sum and integral, we can hope to get

$$\begin{aligned} j(x, \xi) &= \sum_{\alpha} \frac{1}{\alpha!} \int_{\mathbb{R}^N} e^{2\pi i x \cdot \eta} D_{\xi}^{\alpha} g(x, \xi) \eta^{\alpha} \widehat{h}(\eta, \xi) d\eta \\ &= \sum_{\alpha} \frac{(2\pi i)^{-|\alpha|}}{\alpha!} D_{\xi}^{\alpha} g(x, \xi) \int_{\mathbb{R}^N} e^{2\pi i x \cdot \eta} (D_x^{\alpha} h)^{\widehat{}}(\eta, \xi) d\eta. \end{aligned}$$

In view of the Fourier inversion formula, we might therefore expect to obtain

$$j(x, \xi) = \sum_{\alpha} \frac{(2\pi i)^{-|\alpha|}}{\alpha!} D_{\xi}^{\alpha} g(x, \xi) D_x^{\alpha} h(x, \xi).$$

We shall see that such a formula is meaningful, but in an asymptotic sense and not as an equality.

This discussion suggests four mathematical questions that we want to address:

- (i) If we are given a possibly divergent infinite series of symbols as on the right side of the formula for $j(x, \xi)$ above, how can we extract a genuine symbol to represent the sum of the series?
- (ii) Put $G(x, D_x + \xi)\varphi(x) = \int_{\mathbb{R}^N} e^{2\pi i x \cdot \eta} g(x, \eta + \xi) \widehat{\varphi}(\eta) d\eta$. In what sense of \sim is it true that $G(x, D_x + \xi)\varphi(x) \sim \sum_{\alpha} \frac{(2\pi i)^{-|\alpha|}}{\alpha!} D_{\xi}^{\alpha} g(x, \xi) D_x^{\alpha} \varphi(x)$?
- (iii) How can we handle the matter of compact support?
- (iv) How can we show, under suitable hypotheses that take (iii) into account, that $j(x, \xi)$ is given by $G(x, D_x + \xi)(h(x, \xi))$ and therefore that we obtain a formula from (ii) for $j(x, \xi)$ involving \sim ?

The path that we shall follow is direct but not optimal. In Section VIII.6 we shall take note of an approach that is tidier and faster, but insufficiently motivated by the present considerations.

Question (i) is fully addressed by the following theorem.

Theorem 7.20. Suppose that $\{m_j\}_{j \geq 0}$ is a sequence in \mathbb{R} decreasing to $-\infty$, and suppose for $j \geq 0$ that $g_j(x, \xi)$ is a symbol in $S_{1,0}^{m_j}(U)$. Then there exists a symbol $g(x, \xi)$ in $S_{1,0}^{m_0}(U)$ such that for all $n \geq 0$,

$$g(x, \xi) - \sum_{j=0}^{n-1} g_j(x, \xi) \quad \text{is in } S_{1,0}^{m_n}(U).$$

The theorem is proved in the same way that we constructed a right parametrix for an elliptic differential operator earlier in this section. We can now give a

precise meaning to \sim in terms of a notion of an asymptotic series. If $\{m_j\}_{j \geq 0}$ is a sequence in \mathbb{R} decreasing to $-\infty$, if $g(x, \xi)$ is a symbol in $S_{1,0}^{m_0}(U)$, and if $g_j(x, \xi)$ is a symbol in $S_{1,0}^{m_j}(U)$ for each $j \geq 0$, then we write

$$g(x, \xi) \sim \sum_{j=0}^{\infty} g_j(x, \xi)$$

if for all $n \geq 0$,

$$g(x, \xi) - \sum_{j=0}^{n-1} g_j(x, \xi) \text{ is in } S_{1,0}^{m_n}(U).$$

If the given sequence $\{m_j\}_{j \geq 0}$ is a finite sequence ending with m_r , we can extend it to an infinite sequence with $g_j(x, \xi) = 0$ for $j > r$, and in this case the definition of \sim is to be interpreted to mean that $g(x, \xi) - \sum_{j=0}^r g_j(x, \xi)$ is the symbol of a smoothing operator.

For (ii), we have just attached a meaning to \sim . We define $G(x, D_x + \xi)\varphi(x) = \int_{\mathbb{R}^N} e^{2\pi i x \cdot \eta} g(x, \eta + \xi) \widehat{\varphi}(\eta) d\eta$. The precise statement that is proved to yield the asymptotic expansion of (ii) is the following.

Proposition 7.21. Let U be open in \mathbb{R}^N , fix g in $S_{1,0}^m(U)$, and let K be a compact subset of U . Then for any nonnegative integers M and R such that $R > m + N$, there exists a constant C such that

$$\begin{aligned} & \left| G(x, D_x + \xi)\varphi(x) - \sum_{|\alpha| < n} \frac{(2\pi i)^{-|\alpha|}}{\alpha!} D_\xi^\alpha g(x, \xi) D_x^\alpha \varphi(x) \right| \\ & \leq C \left\{ (1 + |\xi|^m) \int_{|\xi + \eta| \leq |\xi|/2} |\widehat{\varphi}(\eta)| d\eta \right. \\ & \quad \left. + \sum_{|\alpha|=N} |\xi|^{m-R} \sup_y [|D^\alpha \varphi(y)| (1 + |\xi||x - y|)^{-M}] \right\} \end{aligned}$$

for all φ in C_K^∞ , all x in K , and all ξ with $|\xi| \geq 1$.

We shall not make further explicit use of this proposition. The proof of the result is long, and we omit any discussion of it.

We turn to questions (iii) and (iv). Question (iii) is addressed by a definition and some remarks concerning it, and question (iv) is addressed by the theorem that comes after those remarks. Continuing with our pseudodifferential operator G on the open set U , we say that G is **properly supported** if the subset $\text{support}(\mathcal{G})$ of $U \times U$ has compact intersection with $K \times U$ and with $U \times K$ for every compact subset K of U . See Figure 7.2.

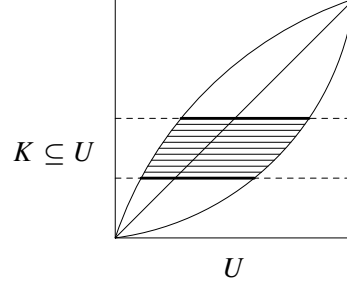

FIGURE 7.2. Nature of the support of the distribution kernel of a properly supported pseudodifferential operator. The open set U in this case is an open interval, and the oval-shaped region represents $\text{support}(\mathcal{G})$. The shaded region is an example of a set $(U \times K) \cap \text{support}(\mathcal{G})$.

Suppose that G is properly supported, K is compact in U , and φ is in $C_{\text{com}}^{\infty}(U)$ with support contained in K . Introduce projections $p_1(x, y) = x$ and $p_2(x, y) = y$. Define $L = p_1((U \times K) \cap \text{support}(\mathcal{G}))$; the set L is compact since G is properly supported and since the continuous image of a compact set is compact. Let us see that $G\varphi$ has support contained in L . To do so, we write $\psi \otimes \varphi$ for the function $(x, y) \mapsto \psi(x)\varphi(y)$, and then we have

$$\langle G\varphi, \psi \rangle = \int_{\mathbb{R}^N} \int_U \int_U e^{2\pi i(x-y)\cdot \xi} g(x, \xi) \psi(x) \varphi(y) dy dx d\xi = \langle \mathcal{G}, \psi \otimes \varphi \rangle.$$

If ψ is in $C_{\text{com}}^{\infty}(L^c \cap U)$, then $F = p_1^{-1}(\text{support } \psi) \cap p_2^{-1}(\text{support } \varphi)$ is the compact support of $\psi \otimes \varphi$, and

$$F \cap \text{support}(\mathcal{G}) \subseteq p_1^{-1}(L^c) \cap (U \times K) \cap \text{support}(\mathcal{G}) = p_1^{-1}(L^c) \cap p_1^{-1}(L) = \emptyset.$$

Thus $\langle \mathcal{G}, \psi \otimes \varphi \rangle = 0$, $\langle G\varphi, \psi \rangle = 0$, and $G\varphi$ is supported in L .

Thus the properly supported pseudodifferential operator G carries $C_{\text{com}}^{\infty}(U)$ into itself, and Lemma 5.2 shows that it does so continuously. Then G is continuous also as a mapping of the dense vector subspace $C_{\text{com}}^{\infty}(U)$ of $C^{\infty}(U)$ into $C^{\infty}(U)$. Because of the completeness of $C^{\infty}(U)$, G extends to a continuous map of $C^{\infty}(U)$ into itself.

Similarly one checks that any properly supported pseudodifferential operator carries $\mathcal{E}'(U)$ into $\mathcal{E}'(U)$. Therefore the composition $G \circ H$ of two pseudodifferential operators, whether regarded as acting on $C_{\text{com}}^{\infty}(U)$ or as acting on $\mathcal{E}'(U)$, is well defined if H is properly supported.

Theorem 7.22. Let U be an open subset of \mathbb{R}^N .

(a) If G is a pseudodifferential operator on U , then there exists a properly supported pseudodifferential operator $G^\#$ on U such that $G - G^\#$ is in $S_{1,0}^{-\infty}(U)$, hence such that $G - G^\#$ is a smoothing operator.

(b) If G and H are properly supported pseudodifferential operators on U with symbols g in $S_{1,0}^m(U)$ and h in $S_{1,0}^{m'}(U)$, then $G \circ H$ is a properly supported pseudodifferential operator with symbol j in $S_{1,0}^{m+m'}(U)$, and

$$j(x, \xi) \sim \sum_{\alpha} \frac{(2\pi i)^{-|\alpha|}}{\alpha!} D_{\xi}^{\alpha} g(x, \xi) D_x^{\alpha} h(x, \xi).$$

All that is needed from (b) in many cases is the following weaker statement.

Corollary 7.23. Let U be an open subset of \mathbb{R}^N . If G and H are properly supported pseudodifferential operators on U with symbols g in $S_{1,0}^m(U)$ and h in $S_{1,0}^{m'}(U)$, then $G \circ H$ is a properly supported pseudodifferential operator whose symbol $j(x, \xi)$ is in $S_{1,0}^{m+m'}(U)$ and has the property that

$$j(x, \xi) - g(x, \xi)h(x, \xi)$$

is a symbol in $S_{1,0}^{m+m'-1}(U)$.

This is enough of the general theory so that we can see how to prove a theorem with consequences beyond the subject of pseudodifferential operators. A pseudodifferential operator G on U with symbol $g(x, \xi)$ in $S_{0,1}^m(U)$ is said to be **elliptic of order m** if for each compact subset K of U , there are constants C_K and M_K such that

$$|g(x, \xi)| \geq C_K (1 + |\xi|)^m \quad \text{for } x \in K \text{ and } |\xi| \geq M_K.$$

In particular, an elliptic differential operator of order m satisfies this condition. A (two-sided) **parametrix** H for a properly supported pseudodifferential operator G with symbol $g \in S_{1,0}^m(U)$ is a properly supported pseudodifferential operator H of order $-m$ such that $H \circ G = 1 + \text{smoothing}$ and $G \circ H = 1 + \text{smoothing}$.

Theorem 7.24. If G is a properly supported elliptic pseudodifferential operator of order m , then G has a parametrix H .

REMARKS. We saw in Theorem 7.19 that $\text{sing supp } Gf \subseteq \text{sing supp } f$ for f in $\mathcal{E}'(U)$. The same argument as with the left parametrix before that theorem shows now from the parametrix of Theorem 7.24 that $\text{sing supp } Gf \supseteq \text{sing supp } f$ and therefore that $\text{sing supp } Gf = \text{sing supp } f$ for f in $\mathcal{E}'(U)$. In particular, solutions of elliptic equations are smooth wherever the given data are smooth.

PARTIAL PROOF. Let $\rho : U \times \mathbb{R}^n \rightarrow [0, 1]$ be a smooth function with the properties that

- (i) ρ equals 1 in a neighborhood of each point (x, ξ) where $g(x, \xi) = 0$,
- (ii) for each compact subset K of U , there is a constant T_K such that $\rho(x, \xi) = 0$ for x in K and $|\xi| \geq T_K$.

We omit the verification that ρ exists and is the symbol of a smoothing operator. Put

$$h_0(x, \xi) = (1 - \rho(x, \xi))g(x, \xi)^{-1}.$$

This is a smooth function by (i), and we omit the step of checking that h_0 is in $S_{1,0}^{-m}(U)$. Let H_0 be the pseudodifferential operator with symbol h_0 . Apply Theorem 7.22a to find a properly supported $H_0^\#$ whose symbol $h_0^\#$ has $h_0^\# \sim h_0$. We write $h_0^\# = h_0 + r_0$ with r_0 in $S_{1,0}^{-\infty}(U)$.

Corollary 7.23 shows that $H_0^\#G$ is a well-defined properly supported operator whose symbol $j_0(x, \xi)$ is in $S_{1,0}^0(U)$ and has the property that $j_0 - h_0^\#g$ is in $S_{1,0}^{-1}(U)$. Since

$$j_0 - h_0^\#g = j_0 - (h_0 + r_0)g = j_0 - [(1 - \rho)g^{-1} + r_0]g = j_0 - 1 + \rho - r_0g$$

and since ρ and r_0g are the symbols of smoothing operators, $j_0 - 1$ must be in $S_{1,0}^{-1}(U)$. Therefore $H_0^\#G = 1 + R$ for a pseudodifferential operator R whose symbol r is in $S_{1,0}^{-1}(U)$.

The equality $H_0^\#G = 1 + R$ shows that R is properly supported. By Corollary 7.23, R^k is a properly supported pseudodifferential operator for all integers $k \geq 1$, and its symbol r_k is in $S_{1,0}^{-k}(U)$. We form the asymptotic series

$$1 - r_1 + r_2 - r_3 + \cdots$$

and use Theorems 7.20 and 7.22a to obtain a properly supported pseudodifferential operator E whose symbol is in $S_{1,0}^0(U)$ and has

$$e \sim 1 - r_1 + r_2 - r_3 + \cdots. \quad (*)$$

For any integer $n \geq 1$, we have

$$\begin{aligned} & (1 - R + R^2 - R^3 + \cdots \pm R^{n-1})H_0^\#G \\ &= (1 - R + R^2 - R^3 + \cdots \pm R^{n-1})(1 + R) = 1 \mp R^n. \quad (**) \end{aligned}$$

Because of (*), $E - (1 - R + R^2 - R^3 + \cdots \pm R^{n-1})$ has symbol in $S_{1,0}^{-n}(U)$. Since the symbol j_0 of $H_0^\#G$ is in $S_{1,0}^0(U)$, the product

$$(E - (1 - R + R^2 - R^3 + \cdots \pm R^{n-1}))H_0^\#G \quad \text{has symbol in } S_{1,0}^{-n}(U).$$

Also, (**) implies that

$$(1 - R + R^2 - R^3 + \cdots \pm R^{n-1})H_0^\#G - 1 = \mp R^n \quad \text{has symbol in } S_{1,0}^{-n}(U).$$

Adding shows that

$$EH_0^\#G - 1 \quad \text{has symbol in } S_{1,0}^{-n}(U).$$

Since n is arbitrary, $EH_0^\#G - 1$ is a smoothing operator. Thus $H = EH_0^\#$ is a left parametrix for G .

In similar fashion we can use the assumption “properly supported” to obtain a right parametrix \tilde{H} for G . We omit the details. The operators H and \tilde{H} give us equations

$$HG = 1 + S \quad \text{and} \quad G\tilde{H} = 1 + \tilde{S}$$

for suitable properly supported smoothing operators S and \tilde{S} . Computing the product $HG\tilde{H}$ in two ways shows that

$$HG\tilde{H} = (1 + S)\tilde{H} = \tilde{H} + S\tilde{H} = \tilde{H} + \text{smoothing}$$

$$\text{and} \quad HG\tilde{H} = H(1 + \tilde{S}) = H + H\tilde{S} = H + \text{smoothing}.$$

Hence $H = \tilde{H} + S_0$ with S_0 properly supported smoothing. Consequently

$$GH = G\tilde{H} + GS_0 = 1 + \tilde{S} + GS_0 = 1 + \text{smoothing},$$

and the left parametrix H is also a right parametrix. \square

BIBLIOGRAPHICAL REMARKS. The proof of Theorem 7.7 is adapted from Taylor’s *Pseudodifferential Operators*, and the proof of Theorem 7.12 is taken from the book by Bers, John, and Schechter. The approach to pseudodifferential operators used in Section 6 is now considered outdated, and a more streamlined approach requiring additional motivation appears in Section VIII.6.

7. Problems

1. Suppose that $P(x, D) = \sum_{|\alpha| \leq m} a_\alpha(x) D^\alpha$ with each a_α in $C^\infty(\Omega)$. Prove that if $P(x, D)u = 0$ for all functions $u \in C^m(\Omega)$, then all the coefficients a_α are 0.
2. **(Harmonic measure)** Let Ω be a bounded nonempty connected open subset of \mathbb{R}^N , let $\partial\Omega$ be its boundary $\partial\Omega = \Omega^{\text{cl}} - \Omega$, and let L be an elliptic linear differential operator on Ω of the form $L(u) = \sum_{i,j} b_{ij}(x) D_i D_j u + \sum_k c_k(x) D_k u$ with real-valued coefficients of class C^2 such that $b_{ij}(x) = b_{ji}(x)$ for all i and j . Let S be the vector subspace of real-valued continuous functions u on Ω^{cl} such that $Lu(x) = 0$ for all $x \in \Omega$. Prove for each point p in Ω that there exists a Borel measure μ_p on $\partial\Omega$ with $\mu_p(\partial\Omega) = 1$ such that $u(p) = \int_{\partial\Omega} u(x) d\mu_p(x)$ for all u in S .

3. This problem identifies a fundamental solution of the Cauchy–Riemann operator in \mathbb{R}^2 . It makes use of Green’s Theorem, which relates line integrals in \mathbb{R}^2 with double integrals, for an annulus centered at the origin.
- For φ in $C_{\text{com}}^\infty(\mathbb{R}^2)$, let $P(x, y) = \frac{x\varphi(x, y)}{x^2+y^2}$ and $Q(x, y) = \frac{y\varphi(x, y)}{x^2+y^2}$. Prove that $\lim_{\varepsilon \downarrow 0} \oint_{|(x, y)|=\varepsilon} (P dx + Q dy) = 0$.
 - With P and Q as in (a), verify that $\frac{\partial Q}{\partial x} - \frac{\partial P}{\partial y} = \frac{y\varphi_x - x\varphi_y}{x^2+y^2}$.
 - Conclude from (a) and (b) that $\iint_{\mathbb{R}^2} \frac{y\varphi_x - x\varphi_y}{x^2+y^2} dx dy = 0$.
 - Repeat (a) with $P(x, y) = -\frac{y\varphi(x, y)}{x^2+y^2}$ and $Q(x, y) = \frac{x\varphi(x, y)}{x^2+y^2}$, showing that $\lim_{\varepsilon \downarrow 0} \oint_{|(x, y)|=\varepsilon} (P dx + Q dy) = 2\pi\varphi(0, 0)$ if the line integral is taken counterclockwise around the circle.
 - With P and Q as in (d), verify that $\frac{\partial Q}{\partial x} - \frac{\partial P}{\partial y} = \frac{x\varphi_x + y\varphi_y}{x^2+y^2}$.
 - Conclude from (d) and (e) that $\iint_{\mathbb{R}^2} \frac{x\varphi_x + y\varphi_y}{x^2+y^2} = -2\pi\varphi(0, 0)$.
 - Conclude from (c) and (f) that $\frac{1}{2\pi} \iint_{\mathbb{R}^2} \frac{1}{z} \frac{\partial \varphi}{\partial \bar{z}} dx dy = -\varphi(0, 0)$.
 - Let T be the locally integrable function $1/(2\pi z)$, regarded as a member of $\mathcal{D}'(\mathbb{R}^2)$. Prove that $\frac{\partial}{\partial \bar{z}}(T) = \delta$.
4. On \mathbb{R}^1 , the **Heaviside distribution** H is the distribution given by the **Heaviside function** $H(x)$ equal to 1 for $x \geq 0$ and to 0 for $x < 0$.
- Prove that $D_x H = \delta$, so that H is a fundamental solution for the elliptic operator D_x on \mathbb{R}^1 .
 - Show that the function $f(x) = \max\{x, 0\}$ on $\Omega = (-1, 1)$ has the Heaviside function as weak derivative on Ω and that f is in $L_1^p(\Omega)$ for every p with $1 \leq p < \infty$.
 - Does the restriction of the Heaviside function to $\Omega = (-1, 1)$ have a weak derivative on Ω ? Why or why not?
 - Show that the distribution $H \times \delta$ on \mathbb{R}^2 given by $\langle H \times \delta, \varphi \rangle = \int_0^\infty \varphi(x, 0) dx$ for $\varphi \in C_{\text{com}}^\infty(\mathbb{R}^2)$ is a fundamental solution of the operator D_x on \mathbb{R}^2 .
 - Find the support and the singular support of the distribution H on \mathbb{R}^1 and of the distribution $H \times \delta$ on \mathbb{R}^2 .
5. Let U be an open set in \mathbb{R}^N containing 0, let f be in $\mathcal{E}'(U)$, and let $P(D)$ be a linear differential operator with constant coefficients and with order ≥ 1 . By taking into account the theory of periodic distributions in Problems 12–13 of Chapter V and by suitably adapting the proof that Lemma 7.8 implies Theorem 7.7, prove that the equation $P(D)u = f$ has a distribution solution in some neighborhood of 0.

Problems 6–9 prove the global version of the Cauchy–Kovalevskaya Theorem given as Theorem 7.2 for the linear constant-coefficient case. The result is an ingredient used in deriving Corollary 7.15 from Theorem 7.14. For the statement the domain variables are t and x with $x = (x_1, \dots, x_N)$, and the unknown functions are the p

components of a function $u(t, x)$ with values in \mathbb{C}^p . Write D_t for $\partial/\partial t$ and D_j for $\partial/\partial x_j$. The Cauchy problem in question is

$$D_t u = \sum_{j=1}^N A_j D_j u + B u + F(t, x),$$

$$u(0, x) = g(x),$$

where A_j and B are p -by- p matrices of complex constants, F is an entire holomorphic function from \mathbb{C}^{N+1} to \mathbb{C}^p , and g is an entire holomorphic function from \mathbb{C}^N to \mathbb{C}^p . The conclusion is that the unique formal power-series solution of the Cauchy problem converges and defines an entire holomorphic function from \mathbb{C}^{N+1} to \mathbb{C}^p that solves the problem. For a vector $v = (v_1, \dots, v_p)$ in \mathbb{C}^p , let $\|v\|_\infty = \max\{|v_1|, \dots, |v_p|\}$.

6. Let α denote a multi-index $\alpha = (\alpha_1, \dots, \alpha_N)$ of integers ≥ 0 . Prove that

$$|\alpha|! \leq (|\alpha|)!, \text{ that } \sum_{|\alpha|=l} \frac{1}{\alpha!} = \frac{N^l}{l!}, \text{ and that } \sum_{l=0}^{\infty} \binom{q+l}{l} z^l = (1-z)^{-q-1} \text{ if } |z| < 1.$$

7. Show that iterated substitution into the system $D_t u = \sum_{j=1}^N A_j D_j u + B u + F$ leads to an expression for $D_t^m u$ as the sum of two kinds of terms: For one kind, there are 2^m terms of the form $\sum T_1 \cdots T_m D_x^\alpha u$ with each T_i equal to an A_{j_i} or to B , with D^α equal to the product of the D_{j_i} for which $T_i = A_{j_i}$, and with the sum taken over j_i from 1 to N . For the other kind, there are $\sum_{s=0}^{m-1} 2^s = 2^m - 1$ terms with something operating on F , the terms corresponding to s being the ones $\sum T_1 \cdots T_s D_x^\alpha D_t^{m-1-s} F$ with each T_i , the D^α , and the sum all as above.

8. (a) How does one compute $D_x^\beta D_t^m u(0, 0)$ from the expression in the previous problem?

(b) Why is it enough to prove, for any given $r > 0$, that the values $D_x^\beta D_t^m u(0, 0)$ satisfy $\sum_{m \geq 0} \sum_{\beta} (\beta! m!)^{-1} \|D_x^\beta D_t^m u(0, 0)\|_\infty r^{|\beta|+m} < \infty$?

9. Choose a constant $M \geq 1$ with $\|Bv\|_\infty \leq M\|v\|_\infty$ and $\|A_j v\|_\infty \leq M\|v\|_\infty$ for all j . Let R be a positive number to be specified. Choose $C = C(R)$ such that $\sum_{m \geq 0} \sum_{\beta} (\beta! m!)^{-1} \|D_t^m D_x^\beta F(0, 0)\|_\infty R^{|\beta|+m}$ and $\sum_{\beta} (\beta!)^{-1} \|D_x^\beta g(0)\|_\infty R^{|\beta|}$ are both $\leq C$.

(a) Among the 2^m terms of the first kind in Problem 7, show that each one for which k of the m factors T_1, \dots, T_m are B is $\leq M^m N^{m-k} C R^{-(m-k)} (m-k)!$, so that the sum of the contributions from the terms of the first kind to $\|D_t^m u(0, 0)\|_\infty$ is $\leq \sum_{k=0}^m \binom{m}{k} M^m N^{m-k} C R^{-(m-k)} (m-k)!$.

(b) Taking into account the result of Problem 8a, adjust the estimate in part (a) of the present problem to bound the sum of the contributions from the terms of the first kind to $\|D_t^m D_x^\beta u(0, 0)\|_\infty$.

(c) Summing over $m \geq 0, l \geq 0$, and β with $|\beta| = l$ the estimate in part (b) and using the formulas in Problem 6, show that the contribution of the terms of the first kind to the series in Problem 8b is finite if R is chosen large enough so that $Nr/R \leq \frac{1}{2}$ and $2MrN/R < 1$.

- (d) For the $2^m - 1$ terms of the second kind in Problem 7, replace $T_1 \cdots T_s$ by $T_1 \cdots T_{m-1}$, treating the missing factors as the identity I , each such factor accompanying a differentiation D_t . If there are k factors of B , show that the term is $\leq M^{m-1}(N+1)^{m-1-k}CR^{-(m-1-k)}(m-1-k)!$. Arguing in a fashion similar to the previous parts to this problem, show that consequently the contribution of the terms of the second kind to the series in Problem 8b is finite if R is chosen large enough so that $Nr/R \leq \frac{1}{2}$ and $2Mr(N+1)/R < 1$.

Problems 10–12 concern the reduction to a first-order system of the Cauchy problem for a single m^{th} -order partial differential equation that has been solved for $D_x^m u$. They generalize the discussion of a second-order equation in two variables that appeared in Section 1 and reduce Theorems 7.3 and 7.4 to Theorems 7.1 and 7.2, respectively. In two variables (x, y) , the equation is

$$D_x^m u = F(x, y; u; D_x u, D_y u; D_x^2 u, \dots; D_x^{m-1} D_y u, \dots, D_y^m u),$$

and the Cauchy data are

$$D_x^i u(0, y) = f^{(i)}(y) \quad \text{for } 0 \leq i < m.$$

10. In the case of two variables (x, y) , introduce variables $u^{i,j}$ for $i + j \leq m$. Show that the given Cauchy problem is equivalent to the following Cauchy problem for a first-order system

$$\begin{aligned} D_x u^{i,j+1} &= D_y u^{i+1,j} && \text{for } i + j + 1 \leq m, \\ D_x u^{i,0} &= u^{i+1,0} && \text{for } 0 \leq i < m, \\ D_x u^{m,0} &= F_x + u^{1,0} F_{u^{0,0}} + u^{2,0} F_{u^{1,0}} + (D_y u^{1,0}) F_{u^{0,1}} + \cdots + (D_y u^{1,m-1}) F_{u^{0,m}} \end{aligned}$$

with Cauchy data

$$\begin{aligned} u^{i,j}(0, y) &= D_y^j f^{(i)}(y) && \text{for } i + j \leq m, (i, j) \neq (m, 0), \\ u^{m,0}(0, y) &= F(0, y; f^{(0)}(y); f^{(1)}(y), D_y f^{(0)}(y); \dots, D_y^m f^{(0)}(y)). \end{aligned}$$

11. What changes to the setup and argument in Problem 10 are needed to handle more variables, say (x, y_1, \dots, y_{N-1}) ?
12. Back in the situation of two variables (x, y) as in Problem 10, suppose that F is a linear combination, with constant coefficients, of $u, D_x u, D_y u, \dots, D_y^m u$, plus an entire holomorphic function of (x, y) , and suppose that $f^{(0)}, \dots, f^{(m-1)}$ are entire holomorphic functions of y . Prove that the reduction to first order as in Problem 10 leads to a Cauchy problem for a first-order system of the type in Problems 6–9. Conclude that the Cauchy problem for the given m^{th} -order equation in the situation of constant coefficients has an entire holomorphic solution.

CHAPTER VIII

Analysis on Manifolds

Abstract. This chapter explains how the theory of pseudodifferential operators extends from open subsets of Euclidean space to smooth manifolds, and it gives examples to illustrate the usefulness of generalizing the theory in this way.

Section 1 gives a brief introduction to differential calculus on smooth manifolds. The section defines smooth manifolds, smooth functions on them, tangent spaces to smooth manifolds, and differentials of smooth mappings between smooth manifolds, and it proves a version of the Inverse Function Theorem for manifolds.

Section 2 extends the theory of smooth vector fields and integral curves from open subsets of Euclidean space to smooth manifolds.

Section 3 develops a special kind of quotient space, called an “identification space,” suitable for constructing general smooth manifolds, vector bundles and fiber bundles, and covering spaces out of local data. In particular, smooth manifolds may be defined as identification spaces without knowledge of the global nature of the underlying topological space; the only problem is in addressing the Hausdorff property.

Section 4 introduces vector bundles, including the tangent and cotangent bundles to a manifold. A vector bundle determines transition functions, and in turn the transition functions determine the vector bundle via the construction of the previous section. The manifold structures on the tangent and cotangent bundles are constructed in this way.

Sections 5–8 concern pseudodifferential operators, including aspects of the theory useful in solving problems in other areas of mathematics. The emphasis is on operators on scalar-valued functions. Section 5 introduces spaces of smooth functions and their topologies, and it defines spaces of distributions; the theory has to compensate for the lack of a canonical underlying measure on the manifold, hence for the lack of a canonical way to view a smooth function as a distribution. Section 5 goes on to study linear partial differential equations on the manifold; although the symbol of the differential operator is not meaningful, the principal symbol is intrinsically defined as a function on the cotangent bundle. The introduction of pseudodifferential operators on smooth manifolds requires new results for the theory in Euclidean space beyond what is in Chapter VII. Section 6 addresses this matter. A notion of transpose is needed, and it is necessary to understand the effect of diffeomorphisms on Euclidean pseudodifferential operators. To handle these questions, it is useful to enlarge the definition of pseudodifferential operator for Euclidean space and to redo the Euclidean theory from the new point of view. Once that program has been carried out, Section 7 patches together pseudodifferential operators in Euclidean space to obtain pseudodifferential operators on smooth separable manifolds. The notions of pseudolocal, properly supported, composition, and elliptic extend, and the theorems are what one might expect from the Euclidean theory. Again the principal symbol is well defined as a function on the cotangent bundle. Section 8 contains remarks about extending the theory to handle operators carrying sections of one vector bundle to sections of another vector bundle, about some other continuations of the theory, and about applications outside real analysis. The section concludes with some bibliographical material.

1. Differential Calculus on Smooth Manifolds

The goal of this chapter is to explain how aspects of the subject of linear partial differential equations extend from open subsets of Euclidean space to smooth manifolds. After an introduction to manifolds and their differential calculus, we shall see the extent to which definitions and theorems about distributions, differential operators, and pseudodifferential operators carry over from local facts about Euclidean space to global facts about smooth manifolds. We shall see also how certain important systems of differential equations can conveniently be expressed globally in terms of operators from one vector bundle to another.

The present section introduces smooth manifolds, smooth functions on them, tangent spaces to smooth manifolds, differentials of smooth mappings between smooth manifolds, and a version of the Inverse Function Theorem for manifolds.

We begin with the definition of smooth manifold. Let M be a Hausdorff topological space, and fix an integer $n \geq 0$. A **chart** on M of dimension n is a homeomorphism $\kappa : M_\kappa \rightarrow \tilde{M}_\kappa$ of an open subset M_κ of M onto an open subset \tilde{M}_κ of \mathbb{R}^n ; the chart κ is said to be **about** a point p in M if p is in the domain M_κ of κ . We say that M is a **manifold** if there is an integer $n \geq 0$ such that each point of M has a chart of dimension n about it.

A **smooth structure** of dimension n on a manifold M is a family \mathcal{F} of n -dimensional charts with the following three properties:

- (i) any two charts κ and κ' in \mathcal{F} are smoothly **compatible** in the sense that $\kappa' \circ \kappa^{-1}$, as a mapping of the open subset $\kappa(M_\kappa \cap M_{\kappa'})$ of \mathbb{R}^n to the open subset $\kappa'(M_\kappa \cap M_{\kappa'})$ of \mathbb{R}^n , is smooth and has a smooth inverse,
- (ii) the system of compatible charts κ is an **atlas** in the sense that the domains M_κ together cover M ,
- (iii) \mathcal{F} is maximal among families of compatible charts on M .

A **smooth manifold of dimension n** is a manifold together with a smooth structure of dimension n . In the presence of an understood atlas, a chart will be said to be **compatible** if it is compatible with all the members of the atlas.

Once we have an atlas of compatible n -dimensional charts for a manifold M , i.e., once (i) and (ii) are satisfied, then the family of all compatible charts satisfies (i) and (iii), as well as (ii), and therefore is a smooth structure. In other words, an atlas determines one and only one smooth structure. Thus, as a practical matter, we can construct a smooth structure for a manifold by finding an atlas satisfying (i) and (ii), and the extension of the atlas for (iii) to hold is automatic.

Let us make some remarks about the topology of manifolds. Let M be any manifold, let p be in M , and let $\kappa : M_\kappa \rightarrow \tilde{M}_\kappa$ be a chart about p . Then \tilde{M}_κ is an open neighborhood of $\kappa(p)$. Since \mathbb{R}^n is locally compact, we can find a compact subneighborhood N of $\kappa(p)$ contained in \tilde{M}_κ . Then $\kappa^{-1}(N)$ is a compact neighborhood of p in M , and it follows that M is locally compact. Since M is

by assumption Hausdorff, M is topologically regular. By the Urysohn Metrization Theorem¹ a separable Hausdorff regular space is metrizable; therefore the topology of a manifold is given by a metric if the manifold is separable.²

We shall not assume at any stage that M is connected, and until Section 5 we shall not assume that M is separable.

A simple example of a smooth manifold is \mathbb{R}^n itself, with an atlas consisting of the single chart 1, where 1 is the identity function on \mathbb{R}^n . Another simple example is any nonempty open subset E of a smooth manifold M , which becomes a smooth manifold by taking all the compatible charts κ of M , replacing them by charts $\kappa|_{M_\kappa \cap E}$, and eliminating redundancies. In particular, any open subset of \mathbb{R}^n becomes a smooth manifold since \mathbb{R}^n itself is a smooth manifold.

Two less-trivial classes of examples are spheres and real projective spaces. They can be realized explicitly as metric spaces, and then one can specify an atlas and hence a smooth structure in each case. The details of these examples are discussed in Problems 1–2 at the end of the chapter.

Most manifolds, however, are constructed globally out of other manifolds or are pieced together from local data. The Hausdorff condition usually has to be checked, is often subtle, and is always important. We postpone a discussion of this matter for the moment.

Let us consider functions on smooth manifolds. If p is a point of the smooth n -dimensional manifold M , a compatible chart κ about p can be viewed as giving a **local coordinate system** near p . Specifically if the Euclidean coordinates in \tilde{M}_κ are (u_1, \dots, u_n) , then $q = \kappa^{-1}(u_1, \dots, u_n)$ is a general point of M_κ , and we define n real-valued functions $q \mapsto x_j(q)$ on M_κ by $x_j(q) = u_j$, $1 \leq j \leq n$. Then $\kappa = (x_1, \dots, x_n)$. To refer the functions x_j to Euclidean space \mathbb{R}^n , we use $x_j \circ \kappa^{-1}$, which carries (u_1, \dots, u_n) to u_j .

The way that the functions x_j are referred to Euclidean space mirrors how a more general scalar-valued function on an open subset of M may be referred to Euclidean space, and then we can define the function to be smooth if it is smooth in the sense of Euclidean differential calculus when referred to Euclidean space. It will only occasionally be important whether our scalar-valued functions are real-valued or complex-valued. Accordingly, we shall follow the convention introduced in Chapter IV that \mathbb{F} denotes the field of scalars, either \mathbb{R} or \mathbb{C} ; either field is allowed (consistently throughout) unless some statement is made to the contrary.

Therefore a **smooth function** $f : E \rightarrow \mathbb{F}$ on an open subset E of M is a function with the property, for each $p \in E$ and each compatible chart κ about p ,

¹Theorem 10.45 of *Basic*.

²Some equivalent conditions for separability of a smooth manifold are given in Problem 3 at the end of the chapter.

that $f \circ \kappa^{-1}$ is smooth as a function from the open subset $\kappa(M_\kappa \cap E)$ of \mathbb{R}^n into \mathbb{F} . A smooth function is necessarily continuous.

In verifying that a scalar-valued function f on an open subset E of M is smooth, it is sufficient, with each point in E , to check a condition for only one compatible chart about that point. The reason is the compatibility of the charts: if κ_1 and κ_2 are two compatible charts about p , then $f \circ \kappa_2^{-1}$ is the composition of the smooth function $\kappa_1 \circ \kappa_2^{-1}$ followed by $f \circ \kappa_1^{-1}$.

The space of smooth scalar-valued functions on the open set E will be denoted by $C^\infty(E)$; if we want to insist on a particular field of scalars, we write $C^\infty(E, \mathbb{R})$ or $C^\infty(E, \mathbb{C})$. The space $C^\infty(E)$ is an associative algebra under the pointwise operations, and it contains the constants. The **support** of a scalar-valued function is, as always, the closure of the set where the function is nonzero. We write $C_{\text{com}}^\infty(E)$ for the subset of $C^\infty(E)$ of functions whose support is a compact subset of E . The space $C_{\text{com}}^\infty(E)$, as well as the larger space $C^\infty(E)$, separates points of E as a consequence of the following lemma and proposition; the lemma makes essential use of the fact that the manifold is Hausdorff.

Lemma 8.1. If M is a smooth manifold, κ is a compatible chart for M , and f is a function in $C_{\text{com}}^\infty(M_\kappa)$, then the function F defined on M to equal f on M_κ and to equal 0 off M_κ is in $C_{\text{com}}^\infty(M)$ and has support contained in M_κ .

PROOF. The set $S = \text{support}(f)$ is a compact subset of M_κ and is compact as a subset of M since the inclusion of M_κ into M is continuous. Since M is Hausdorff, S is closed in M . The function F is smooth at all points of M_κ and in particular at all points of S , and we need to prove that it is smooth at points of the complement U of S in M . If p is in U , we can find a compatible chart κ' about p with $M_{\kappa'} \subseteq U$. The function F is 0 on $M_{\kappa'} \cap M_\kappa$ since $U \cap \text{support}(f) = \emptyset$, and it is 0 on $M_{\kappa'} \cap M_\kappa^c$ since it is 0 everywhere on M_κ^c . Therefore it is identically 0 on $M_{\kappa'}$ and is exhibited as smooth in a neighborhood of p . Thus F is smooth. \square

Proposition 8.2. Suppose that p is a point in a smooth manifold M , that κ is a compatible chart about p , and that K is a compact subset of M_κ containing p . Then there is a smooth function $f : M \rightarrow \mathbb{R}$ with compact support contained in M_κ such that f has values in $[0, 1]$ and f is identically 1 on K .

PROOF. The set $\kappa(K)$ is a compact subset of the open subset $\tilde{M}_\kappa = \kappa(M_\kappa)$ of Euclidean space, and Proposition 3.5f produces a smooth function g in $C_{\text{com}}^\infty(\tilde{M}_\kappa)$ with values in $[0, 1]$ that is identically 1 on $\kappa(K)$. If f is defined to be $g \circ \kappa$ on M_κ , then f is in $C_{\text{com}}^\infty(M_\kappa)$. Extending f to be 0 on the complement of M_κ in M and applying Lemma 8.1, we see that the extended f satisfies the conditions of the proposition. \square

EXAMPLE. This example shows what can go wrong if the Hausdorff condition is dropped from the definition of smooth manifold. Let X be the disjoint union of two copies of \mathbb{R} , say $(\mathbb{R}, +)$ and $(\mathbb{R}, -)$, with each of them open in X . Define an equivalence relation on X by requiring that every point be equivalent to itself and also that $(x, +)$ be equivalent to $(x, -)$ for $x \neq 0$. The quotient space M of X by this equivalence relation consists of the nonzero elements of one copy of \mathbb{R} , together with two versions of 0, which we denote by 0^+ and 0^- . The topological space M is not Hausdorff since 0^+ and 0^- cannot be separated by disjoint open sets. Let $\mathbb{R}^+ \subseteq M$ be the image of $(\mathbb{R}, +)$ under the quotient map, and define \mathbb{R}^- similarly. Define $\kappa^+ : \mathbb{R}^+ \rightarrow \mathbb{R}^1$ and $\kappa^- : \mathbb{R}^- \rightarrow \mathbb{R}^1$ in the natural way, and then κ^+ and κ^- together behave like an atlas of compatible charts covering M . To proceed with a theory, it is essential to be able to separate points by smooth functions. Smooth functions are in particular continuous, and 0^+ and 0^- cannot be separated by continuous real-valued functions on M . Thus they cannot be separated by smooth functions, and Proposition 8.2 must fail. It is instructive, however, to see just exactly how it does fail. In the proposition let us take $p = 0^+$, $\kappa = \kappa^+$, and $K = \{0^+\}$. We can certainly construct a smooth function f on \mathbb{R}^+ with values in $[0, 1]$ that is 1 on $K = \{0^+\}$ and has compact support L as a subset of \mathbb{R}^+ . However, L is not closed as a subset of M . When f is extended to be 0 off \mathbb{R}^+ , the extended function is not continuous, much less smooth. To be continuous, it would have to be defined to be 1, rather than 0, at 0^- .

Corollary 8.3. Let p be a point of a smooth manifold M , let U be an open neighborhood of p , and let f be in $C^\infty(U)$. Then there is a function g in $C^\infty(M)$ such that $g = f$ in a neighborhood of p .

PROOF. Possibly by shrinking U , we may assume that U is the domain of some compatible chart κ about p . Let K be a compact neighborhood of p contained in U , and use Proposition 8.2 to find h in $C^\infty(M)$ with compact support in U such that h is identically 1 on K . Define g to be the pointwise product hf on U and to be 0 off U . Then g equals f on the neighborhood K of p , and Lemma 8.1 shows that g is everywhere smooth. \square

The Euclidean chain rule yields a necessary condition for a tuple of real-valued functions to provide a local coordinate system near a point, and the Inverse Function Theorem shows the sufficiency of the condition. The details are as in Proposition 8.4 below. Further results of this kind appear in Problems 6–7 at the end of the chapter.

Proposition 8.4. Let M be an n -dimensional smooth manifold, let p be in M , let κ be a chart about p , and let f_1, \dots, f_m be in $C^\infty(M_\kappa, \mathbb{R})$. In order for there to

exist an open neighborhood V of p such that the restriction of $\kappa' = (f_1, \dots, f_m)$ to V is a compatible chart, it is necessary and sufficient that

- (a) $m = n$ and
 (b) $\det \left[\frac{\partial(f_i \circ \kappa^{-1})}{\partial u_j} \right] \neq 0$ at the point $u = \kappa(p)$.

PROOF OF NECESSITY. Let $\kappa' = (f_1, \dots, f_m)$. If κ' is a compatible chart about p when restricted to some neighborhood V of p , then $\kappa' \circ \kappa^{-1}$ and $\kappa \circ \kappa'^{-1}$ are smooth mappings on open sets in Euclidean space that are inverse to each other. By the chain rule the products of their Jacobian matrices in the two orders are the identity matrices of the appropriate size. Therefore $m = n$, and the determinant of the Jacobian matrix of $\kappa' \circ \kappa^{-1}$ at $\kappa(p)$ is not 0. \square

PROOF OF SUFFICIENCY. Let $m = n$. If (b) holds, then the Inverse Function Theorem produces an open neighborhood V' of $\kappa'(p)$ and an open neighborhood $U' \subseteq \tilde{M}_\kappa$ of $\kappa(p)$ such that $\kappa' \circ \kappa^{-1}$ has a smooth inverse g mapping V' one-one onto U' . Let $V = \kappa^{-1}(U')$, and define $h = \kappa^{-1} \circ g$. Then h maps V' one-one onto V and satisfies $h \circ \kappa' = h \circ (\kappa' \circ \kappa^{-1}) \circ \kappa = \kappa^{-1} \circ (g \circ (\kappa' \circ \kappa^{-1})) \circ \kappa = \kappa^{-1} \circ \kappa = 1$. Thus $h = \kappa'^{-1}$ and $\kappa'|_V$ is a chart. To see that the chart $\kappa'|_V$ is compatible, let κ'' be a chart in the given atlas such that $V \cap M_{\kappa''} \neq \emptyset$. Then $\kappa' \circ \kappa''^{-1} = (\kappa' \circ \kappa^{-1}) \circ (\kappa \circ \kappa''^{-1})$ is smooth, and so is $\kappa'' \circ \kappa'^{-1} = \kappa'' \circ h = (\kappa'' \circ \kappa^{-1}) \circ g$. Hence the chart $\kappa''|_V$ is compatible. \square

A **smooth function** $F : E \rightarrow N$ from an open subset E of the n -dimensional smooth manifold M into a smooth k -dimensional manifold N is a continuous function with the property that for each $p \in E$, each compatible M chart κ about p , and each compatible N chart κ' about $F(p)$, the function $\kappa' \circ F \circ \kappa^{-1}$ is smooth from an open neighborhood of $\kappa(p)$ in $\kappa(M_\kappa \cap E) \subseteq \mathbb{R}^n$ into \mathbb{R}^k . The function $\kappa' \circ F \circ \kappa^{-1}$ is what F becomes when it is referred to Euclidean space. Let us examine $\kappa' \circ F \circ \kappa^{-1}$ further.

In a compatible M chart κ about p , we have used (u_1, \dots, u_n) as Euclidean coordinates within \tilde{M}_κ , and the local coordinate functions on M_κ are the members x_j of $C^\infty(M_\kappa, \mathbb{R})$ such that $x_j \circ \kappa^{-1}(u_1, \dots, u_n) = u_j$. In a compatible N chart κ' about $F(p)$, let us use (v_1, \dots, v_k) as Euclidean coordinates within $\tilde{N}_{\kappa'}$, and let us denote the local coordinate functions on $N_{\kappa'}$ by y_i . The formula for y_i is $y_i \circ \kappa'^{-1}(v_1, \dots, v_k) = v_i$. The function $\kappa' \circ F \circ \kappa^{-1}$ takes values of the form (v_1, \dots, v_k) , and the way to extract the i^{th} coordinate function of $\kappa' \circ F \circ \kappa^{-1}$ is to follow it with $y_i \circ \kappa'^{-1}$. Thus when F is referred to Euclidean space, the i^{th} coordinate function of the result is $y_i \circ F \circ \kappa^{-1}$. We shall write F_i for this coordinate function.

If $F : M \rightarrow N$ is a smooth function between smooth manifolds and if F has a smooth inverse, then F is called a **diffeomorphism**.

If M and N are smooth manifolds, then the product $M \times N$ becomes a smooth manifold in a natural way by taking an atlas of $M \times N$ to consist of all products $\kappa \times \kappa'$ of compatible charts of M by compatible charts of N . With this definition of smooth structure for $M \times N$, the projections $M \times N \rightarrow M$ and $M \times N \rightarrow N$ are smooth and so are the inclusions $M \rightarrow M \times \{y\}$ and $N \rightarrow \{x\} \times N$ for any y in N and x in M .

Fix a point p in M . The “tangent space” to M at p will be defined shortly in a way so as to consist of all first-derivative operators on functions at p . Traditionally one uses only real-valued functions in making the definition, but we shall adhere to our convention and allow scalars from either \mathbb{R} or \mathbb{C} except when we need to make a choice. Construction of the tangent space can be done in a concrete fashion, using the coordinate functions x_j , or it can be done with a more abstract definition. The latter approach, which we follow, has the advantage of incorporating all the necessary analysis into the problem of sorting out the definition rather than into incorporating it into a version of the chain rule valid for manifolds. In other words the one result that will need proof will be a statement limiting the size of the tangent space, and the chain rule will become purely a formality.

To the extent that a tangent vector at p is a first derivative operator at p , its effect will depend only on the behavior of functions in a neighborhood of p . Within the abstract approach, there are then two subapproaches. One subapproach works with functions on a fixed but arbitrary open set containing p and looks at a kind of first-derivative-at- p operation on them. The other subapproach works simultaneously with all functions such that any two of them coincide on some neighborhood of p . Either subapproach will work in our present context of smooth manifolds. It turns out, however, that a similar formalism applies to other kinds of manifolds—particularly to complex manifolds and to real-analytic manifolds—and only the second subapproach works for them. We shall therefore introduce the idea of the tangent space to M at p by working simultaneously with all functions such that any two of them coincide on some neighborhood of p . The operative notion is that of a “germ” at p .

To emphasize domains, let us temporarily write (f, U) for a member of $C^\infty(U)$. We consider all such objects such that p lies in U , and we define (f, U) to be equivalent to (g, V) if $f = g$ on some subneighborhood about p of the common domain $U \cap V$. This notion of “equivalent” is readily checked to be an equivalence relation, and we let $\mathcal{C}_p(M)$ be the set of equivalence classes. An equivalence class is called a **germ** of a smooth scalar-valued function at p . The set of germs inherits addition and multiplication from that for functions. Specifically the germ of the sum $(f, U) + (g, V)$ is defined to be the germ of $((f|_{U \cap V}) + (g|_{U \cap V}), U \cap V)$. One has to check that this definition is independent of the choice of representatives, but that is routine. Multiplication is handled similarly. Then one checks that the operations on germs have the usual properties of an associative algebra over \mathbb{F} .

Let us sketch the argument for associativity of addition. Let three germs be given, and let (f, U) , (g, V) , and (h, W) be representatives. A representative of the sum of the three is defined on the intersection $I = U \cap V \cap W$. On I , the restrictions to I satisfy $(f + g) + h = f + (g + h)$ because of associativity for addition of functions; hence the germs of the two sides of the associativity formula are equal, and addition is associative in $\mathcal{C}_p(M)$.

The algebra $\mathcal{C}_p(M)$ admits a distinguished linear function into the field of scalars \mathbb{F} , namely evaluation at p . If a germ is given and (f, U) is a representative, then the value $f(p)$ at p is certainly independent of the choice of representative; thus evaluation at p is well defined on $\mathcal{C}_p(M)$. We denote it by e . Although germs are not functions, we often use the same symbol for a germ as for a representative function in order to remind ourselves how germs behave. A **derivation** of $\mathcal{C}_p(M)$ is a linear function $L : \mathcal{C}_p(M) \rightarrow \mathbb{F}$ such that $L(fg) = L(f)e(g) + e(f)L(g)$. If the germ f is the class of a function (f, U) , then we can define L on the function to be equal to L on the germ, and the formula for L on a product of two functions will be valid on the common domain of the two representative functions.

Any derivation L of $\mathcal{C}_p(M)$ has to satisfy $L(1) = L(1 \cdot 1) = L(1)1 + 1L(1) = 2L(1)$ and thus must annihilate the constant functions and their germs. The derivations of $\mathcal{C}_p(M)$ are also called **tangent vectors** to M at p , and the space of these derivations is called the **tangent space** to M at p and is denoted by $T_p(M)$.

For $M = \mathbb{R}^n$, evaluation of a first partial derivative at p is an example. More generally we can obtain examples for any M as follows: Let κ be a compatible chart with p in M_κ . The specific derivations of $\mathcal{C}_p(M)$ that we construct will depend on the choice of κ . We obtain n examples $\left[\frac{\partial}{\partial x_j}\right]_p$ of derivations of $\mathcal{C}_p(M)$, one for each j with $1 \leq j \leq n$, by the definition

$$\left[\frac{\partial f}{\partial x_j}\right]_p = \frac{\partial(f \circ \kappa^{-1})}{\partial u_j}(\kappa(p)) = \frac{\partial(f \circ \kappa^{-1})}{\partial u_j} \Big|_{(u_1, \dots, u_n) = (x_1(p), \dots, x_n(p))}.$$

For $f = x_i$, we have

$$\left[\frac{\partial x_i}{\partial x_j}\right]_p = \frac{\partial(x_i \circ \kappa^{-1})}{\partial u_j}(x_1(p), \dots, x_n(p)) = \frac{\partial u_i}{\partial u_j}(x_1(p), \dots, x_n(p)) = \delta_{ij}.$$

Consequently the n derivations $\left[\frac{\partial}{\partial x_j}\right]_p$ of $\mathcal{C}_p(M)$ are linearly independent.

Proposition 8.5. Let M be a smooth manifold of dimension n , let p be in M , and let κ be a compatible chart about p . Then the n derivations $\left[\frac{\partial}{\partial x_j}\right]_p$ of $\mathcal{C}_p(M)$ form a basis for the tangent space $T_p(M)$ of M at p , and any derivation L of $\mathcal{C}_p(M)$ satisfies

$$L = \sum_{j=1}^n L(x_j) \left[\frac{\partial}{\partial x_j}\right]_p.$$

PROOF. We know that the n explicit derivations are linearly independent. To prove spanning, let L be a derivation of $\mathcal{C}_p(M)$, and let (f, E) represent a member of $\mathcal{C}_p(M)$. Without loss of generality, we may assume that $E \subseteq M_\kappa$ and that $\kappa(E)$ is an open ball in \mathbb{R}^n . Put $u_0 = (u_{0,1}, \dots, u_{0,n}) = \kappa(p)$, let q be a variable point in E , and define $u = (u_1, \dots, u_n) = \kappa(q)$. Taylor's Theorem³ applied to $f \circ \kappa^{-1}$ on $\kappa(E)$ gives

$$\begin{aligned} f \circ \kappa^{-1}(u) &= f \circ \kappa^{-1}(u_0) + \sum_{j=1}^n (u_j - u_{0,j}) \frac{\partial(f \circ \kappa^{-1})}{\partial u_j}(u_0) \\ &\quad + \sum_{i,j} (u_i - u_{0,i})(u_j - u_{0,j}) R_{ij}(u) \end{aligned}$$

with R_{ij} in $C^\infty(\kappa(E))$. Referring this formula to M , we obtain

$$\begin{aligned} f(q) &= f(p) + \sum_{j=1}^n (x_j(q) - x_j(p)) \left[\frac{\partial f}{\partial x_j} \right]_p \\ &\quad + \sum_{i,j} (x_i(q) - x_i(p))(x_j(q) - x_j(p)) r_{ij}(q) \end{aligned}$$

on E , where $r_{ij} = R_{ij} \circ \kappa$ on E . Because L annihilates constants and has the derivation property, application of L yields

$$\begin{aligned} L(f) &= \sum_{j=1}^n L(x_j) \left[\frac{\partial f}{\partial x_j} \right]_p + \sum_{i,j} (L(x_i)(e(x_j) - x_j(p)) e(r_{ij}) \\ &\quad + (e(x_i) - x_i(p)) L(x_j) e(r_{ij}) + (e(x_i) - x_i(p))(e(x_j) - x_j(p)) L(r_{ij})) \\ &= \sum_{j=1}^n L(x_j) \left[\frac{\partial f}{\partial x_j} \right]_p, \end{aligned}$$

as asserted. □

A smooth function $F : E \rightarrow N$ as above has a “differential” that carries the tangent space to M at p linearly to the tangent space to N at $F(p)$. We shall define the differential, find its matrix relative to local coordinates, and establish a version of the chain rule for smooth manifolds. Let L be in $T_p(M)$, and let g be in $\mathcal{C}_{F(p)}(M)$. Regard g as a smooth function defined on some open neighborhood of $F(p)$, and define $(dF)_p(L)$ to be the member of $T_{F(p)}(N)$ given by $(dF)_p(L)(g) = L(g \circ F)$. To see that $(dF)_p(L)$ is indeed in $T_{F(p)}(N)$, we need to check that $L(g \circ F)$ depends only on the germ of g and not on the choice of representative function; also we need to check the derivation property.

³In the form of Theorem 3.11 of *Basic*.

To check these things, let g and g^* be functions representing the same germ at $F(p)$. Then $g = g^*$ in a neighborhood of $F(p)$, and the continuity of F ensures that $g \circ F = g^* \circ F$ in a neighborhood of p . The derivation L depends only on a germ at p , and thus $(dF)_p(L)(g)$ depends only on the germ of g . For the derivation property we have

$$\begin{aligned} (dF)_p(L)(g_1 g_2) &= L((g_1 g_2) \circ F) = L((g_1 \circ F)(g_2 \circ F)) \\ &= L(g_1 \circ F)(g_2(F(p))) + (g_1(F(p)))L(g_2 \circ F) \\ &= (dF)_p(L)(g_1)(g_2(F(p))) + (g_1(F(p)))(dF)_p(L)(g_2), \end{aligned}$$

and thus $(dF)_p(L)$ is in $T_{F(p)}(N)$.

The mapping $(dF)_p : T_p(M) \rightarrow T_{F(p)}(N)$ is evidently linear, and it is called the **differential** of F at p . We may write dF_p for it if there is no ambiguity; later we shall denote it by $dF(p)$ as well. Proposition 8.5 gives us bases of $T_p(M)$ and $T_{F(p)}(N)$, and we shall determine the matrix of dF_p relative to these bases.

Proposition 8.6. Let M and N be smooth manifolds of respective dimensions n and k , and let $F : M \rightarrow N$ be a smooth function. Fix p in M , let κ be an M chart about p , and let κ' be an N chart about $F(p)$. Relative to the bases $\left[\frac{\partial}{\partial x_j}\right]_p$ of $T_p(M)$ and $\left[\frac{\partial}{\partial y_i}\right]_{F(p)}$ of $T_{F(p)}(N)$, the matrix of the linear function $dF_p : T_p(M) \rightarrow T_{F(p)}(N)$ is $\left[\frac{\partial F_i}{\partial u_j}\right]_{(u_1, \dots, u_n) = (x_1(p), \dots, x_n(p))}$.

REMARK. In other words it is the Jacobian matrix of the set of coordinate functions of the function obtained by referring F to Euclidean space. Hence the differential is the object for smooth manifolds that generalizes the multivariable derivative for Euclidean space. Accordingly, let us make the definition

$$\left[\frac{\partial F_i}{\partial x_j}\right]_p = \left[\frac{\partial F_i}{\partial u_j}\right]_{(u_1, \dots, u_n) = (x_1(p), \dots, x_n(p))}.$$

PROOF. Application of the definitions gives

$$\begin{aligned} dF_p\left(\left[\frac{\partial}{\partial x_j}\right]_p\right)(y_i) &= \left[\frac{\partial}{\partial x_j}\right]_p(y_i \circ F) \\ &= \frac{\partial(y_i \circ F \circ \kappa^{-1})}{\partial u_j}(x_1(p), \dots, x_n(p)) \\ &= \frac{\partial F_i}{\partial u_j}\bigg|_{(u_1, \dots, u_n) = (x_1(p), \dots, x_n(p))}. \end{aligned}$$

The formula in Proposition 8.5 allows us to express any member of $T_{F(p)}(N)$ in terms of its values on the local coordinate functions y_i , and therefore

$$dF_p\left(\left[\frac{\partial}{\partial x_j}\right]_p\right) = \sum_{i=1}^k \frac{\partial F_i}{\partial u_j} \Big|_{(u_1, \dots, u_n) = (x_1(p), \dots, x_n(p))} \left[\frac{\partial}{\partial y_i}\right]_p.$$

Thus the matrix is as asserted. \square

Proposition 8.7 (chain rule). Let M , N , and R be smooth manifolds, and let $F : M \rightarrow N$ and $G : N \rightarrow R$ be smooth functions. If p is in M , then

$$d(G \circ F)_p = dG_{F(p)} \circ dF_p.$$

PROOF. If L is in $T_p(M)$ and h is in $\mathcal{C}_{G(F(p))}(R)$, then the definitions give

$$d(G \circ F)_p(L)(h) = L(h \circ G \circ F) = dF_p(L)(h \circ G) = dG_{F(p)}(dF_p(L)(h)),$$

as asserted. \square

2. Vector Fields and Integral Curves

A **vector field** on an open subset U of \mathbb{R}^n was defined in Chapter IV of *Basic* as a function $X : U \rightarrow \mathbb{R}^n$. The vector field is **smooth** if X is a smooth function. In classical notation, X is written $X = \sum_{j=1}^n a_j(x_1, \dots, x_n) \frac{\partial}{\partial x_j}$, and the function carries (x_1, \dots, x_n) to $(a_1(x_1, \dots, x_n), \dots, a_n(x_1, \dots, x_n))$. The traditional geometric interpretation of X is to attach to each point p of U the vector $X(p)$ as an arrow based at p . This interpretation is appropriate, for example, if X represents the velocity vector at each point in space of a time-independent fluid flow.

Taking the interpretation with arrows into account and realizing that the use of arrows implicitly takes $\mathbb{F} = \mathbb{R}$, we see that an appropriate generalization in the case of a smooth manifold M is this: a vector field attaches to each p in M a member of the tangent space $T_p(M)$. Let us make this definition more precise.

If M is a smooth n -dimensional manifold, let

$$T(M) = \{(p, L) \mid p \in M \text{ and } L \in T_p(M)\},$$

and let $\pi : T(M) \rightarrow M$ be the projection to the first coordinate. A **vector field** X on an open subset U of M is a function from U to $T(M)$ such that $\pi \circ X$ is the

identity on U ; so X is indeed a function whose value at any point p is a tangent vector at p . The value of X at p will be written X_p .

We shall be mostly interested in vector fields that are “smooth.” Ultimately this smoothness will be defined by making $T(M)$ into a smooth manifold known as the **tangent bundle** of M . The local structure of this smooth manifold is easily accessible via Proposition 8.5. That proposition shows that having a chart κ of M singles out an ordered basis of the tangent space at each point in M_κ . Identifying all these tangent spaces with \mathbb{F}^n by means of this ordered basis, we obtain an identification of $\{(p, L) \mid p \in M_\kappa \text{ and } L \in T_p(M)\}$ with $M_\kappa \times \mathbb{F}^n$ and hence with $\tilde{M}_\kappa \times \mathbb{F}^n$. The result is a chart for $T(M)$ that we shall include in our atlas. It will be fairly easy to see how these charts are to be patched together compatibly. The problem in obtaining the structure of a smooth manifold is in proving that $T(M)$ is Hausdorff. Although the Hausdorff property may look evident at first glance, it perhaps looks equally evident for the example with \mathbb{R}^+ and \mathbb{R}^- in the previous section, and there the Hausdorff property fails. Thus some care is appropriate. We shall study this matter more carefully in Section 3 and complete the construction of the smooth structure on the tangent bundle in Section 4.

For now we shall proceed with a more utilitarian definition of smoothness of a vector field. A vector field X on M carries $C^\infty(U)$, for any open subset U of M , to a space of functions on M by the rule $(Xf)(p) = X_p(f)$. We say that the vector field X on M is **smooth** if Xf is in $C^\infty(U)$ whenever U is open in M and f is in $C^\infty(U)$.

Proposition 8.8. Let X be a vector field on a smooth n -dimensional manifold M . If $\kappa = (x_1, \dots, x_n)$ is a compatible chart and if f is in $C^\infty(M_\kappa)$, then

$$Xf(p) = \sum_i \frac{\partial f}{\partial x_i}(p) (Xx_i)(p) \quad \text{for } p \in M_\kappa.$$

The vector field X is smooth if and only if Xx_i is smooth for each coordinate function x_i of each compatible chart on M .

PROOF. The displayed formula is immediate from Proposition 8.5. To see that if X is smooth, then Xx_i is smooth on M_κ , let q be a point of M_κ and choose, by Proposition 8.2, a function g in $C^\infty(M)$ such that $g = x_i$ in a neighborhood of q . Then $\frac{\partial g}{\partial x_j}(p) = \delta_{ij}$ identically for p in that neighborhood of q . The displayed formula shows that $Xg(p) = Xx_i(p)$ for p in that neighborhood. Since Xg is smooth everywhere, Xx_i must be smooth in that neighborhood of q .

Conversely suppose that each Xx_i is smooth. Let f be in $C^\infty(M)$. Since $\frac{\partial f}{\partial x_i}(p)$ means $\frac{\partial(f \circ \kappa^{-1})}{\partial u_i} \Big|_{u=\kappa(p)}$ and since $f \circ \kappa^{-1}$ is in $C^\infty(\tilde{M}_\kappa)$, the function $p \mapsto \frac{\partial f}{\partial x_i}(p)$ is in $C^\infty(U)$. Since each Xx_i is in $C^\infty(M_\kappa)$ by assumption, $Xf|_{M_\kappa}$ is in $C^\infty(M_\kappa)$. Then Xf must be $C^\infty(M)$ because the compatible chart κ is arbitrary. \square

A smooth **curve** $c(t)$ on the smooth manifold M is a smooth function c from an open interval of \mathbb{R}^1 into M . The smooth curve $c(t)$ is an **integral curve** for a smooth real-valued vector field X if $X_{c(t)} = dc_t\left(\frac{d}{dt}\right)$ for all t in the domain of c . Integral curves in open subsets of Euclidean space were discussed in Section IV.2 of *Basic*. We shall now transform those results into results about integral curves on smooth manifolds.

Let M be a smooth manifold of dimension n , let $\kappa = (x_1, \dots, x_n)$ be a compatible chart, and let $X = \sum_{j=0}^n a_j(x) \frac{\partial}{\partial x_j}$ be the local expression from Proposition 8.8 for a smooth real-valued vector field X on M within M_κ , so that a_j is in $C^\infty(M_\kappa, \mathbb{R})$. Let $c(t)$ be a smooth curve on U . Define $b_j(y) = a_j(\kappa^{-1}(y))$ for $y \in \tilde{M}_\kappa \subseteq \mathbb{R}^n$, and let $y(t) = (y_1(t), \dots, y_n(t)) = \kappa(c(t))$, so that $y(t)$ is a smooth curve on \tilde{M}_κ . Then we have

$$\begin{aligned} X_{c(t)}f &= \sum_{i=1}^n \left[a_i(x) \frac{\partial f}{\partial x_i} \right]_{c(t)} = \sum_{i=1}^n (a_i \circ \kappa^{-1}) \circ (\kappa(c(t))) \left[\frac{\partial f}{\partial x_i} \right]_{c(t)} \\ &= \sum_{i=1}^n b_i(y(t)) \left[\frac{\partial f}{\partial x_i} \right]_{c(t)} \end{aligned}$$

and

$$\begin{aligned} dc_t\left(\frac{d}{dt}\right)(f) &= \frac{d}{dt}(f \circ c)(t) = \frac{d}{dt}(f \circ \kappa^{-1} \circ y)(t) \\ &= \sum_{i=1}^n \left[\frac{\partial(f \circ \kappa^{-1})}{\partial u_i} \right]_{u=y(t)} \left[\frac{dy_i(t)}{dt} \right]_t = \sum_{i=1}^n \left[\frac{dy_i(t)}{dt} \right]_t \left[\frac{\partial f}{\partial x_i} \right]_{c(t)}. \end{aligned}$$

The two left sides are equal for all f , i.e., $c(t)$ is an integral curve for X on M_κ in M , if and only if the two right sides are equal for all f , i.e., $y(t)$ satisfies

$$\frac{dy_j}{dt} = b_j(y) \quad \text{for } 1 \leq j \leq n.$$

The latter condition is the condition for $y(t)$ to be an integral curve for the vector field $\sum_{j=0}^n b_j(y) \frac{\partial}{\partial y_j}$ on \tilde{M}_κ in \mathbb{R}^n . Applying Proposition 4.4 of *Basic*, which in turn is an immediate consequence of the standard existence-uniqueness results for systems of ordinary differential equations, we obtain the following generalization to manifolds.

Proposition 8.9. Let X be a smooth real-valued vector field on a smooth manifold M , and let p be in M . Then there exist an $\varepsilon > 0$ and an integral curve $c(t)$ defined for $-\varepsilon < t < \varepsilon$ such that $c(0) = p$. Any two integral curves c and d for X having $c(0) = d(0) = p$ coincide on the intersection of their domains.

As in the Euclidean case, the interest is not only in Proposition 8.9 in isolation but also in what happens to the integral curves when X is part of a family of vector fields.

Proposition 8.10. Let $X^{(1)}, \dots, X^{(m)}$ be smooth real-valued vector fields on a smooth n -dimensional manifold M , and let p be in M . Let V be a bounded open neighborhood of 0 in \mathbb{R}^m . For λ in V , put $X_\lambda = \sum_{j=1}^m \lambda_j X^{(j)}$. Then there exist an $\varepsilon > 0$ and a system of integral curves $c(t, \lambda)$, defined for $t \in (-\varepsilon, \varepsilon)$ and $\lambda \in V$, such that $c(\cdot, \lambda)$ is an integral curve for X_λ with $c(0, \lambda) = p$. Each curve $c(t, \lambda)$ is unique, and the function $c : (-\varepsilon, \varepsilon) \times V \rightarrow M$ is smooth. If $m = n$, if the vectors $X^{(1)}(p), \dots, X^{(m)}(p)$ are linearly independent, and if δ is any positive number less than ε , then $c(\delta, \cdot)$ is a diffeomorphism from an open subneighborhood of 0 (depending on δ) onto an open subset of M , and its inverse defines a chart about p .

PROOF. All but the last sentence is just a translation of Proposition 4.5 of *Basic* into the setting with manifolds. For the last sentence, Proposition 4.5 of *Basic* establishes that the the Jacobian matrix at $\lambda = 0$ of the function $\lambda \mapsto c(\delta, \lambda)$ transferred to Euclidean space is nonsingular, and the rest follows from Proposition 8.4. \square

3. Identification Spaces

We saw in a 1-dimensional example in Section 1 that the Hausdorff condition is subtle (and does not always hold) when one tries to build a smooth manifold out of smooth charts. In Section 2 we saw that it would be desirable to obtain a smooth manifold structure on the tangent bundle of a smooth manifold in order to make the definition of smoothness of vector fields more evident from the smooth structure, and the natural way of proceeding was to piece the structure together from charts that were products of charts for the smooth manifold by mappings on whole Euclidean spaces. The example in Section 1 serves as a reminder, however, that we should not take the Hausdorff condition for granted in working with the tangent bundle.

In fact, the construction in both instances appears in a number of important situations in mathematics. One is in constructing “vector bundles” and more general “fiber bundles” out of local data, and another is in constructing covering spaces in the theory of fundamental groups. Still a third is in the construction of restricted direct products⁴ in Problem 30 in Chapter IV.

⁴In fairness it should be said that restricted direct products, which involve a direct limit, are more easily handled by the method in Chapter IV than by a construction analogous to that of the tangent bundle.

For a clearer picture of what is happening, let us abstract the situation. The idea is to build complicated topological spaces out of simpler ones by piecing together local data. For lack of a better name for the abstract construction, we shall call the result an “identification space.” A simple example of the use of charts in defining manifold structures will point the way to the general definition.

EXAMPLE. Suppose, by way of being concrete, that we have overlapping open sets U_1 and U_2 in \mathbb{R}^n . We take U_1 and U_2 as completely understood, and we want to describe $U_1 \cup U_2$ as a topological space. Let X be the **disjoint union** of U_1 and U_2 , which we write as $X = U_1 \sqcup U_2$. By definition, X as a set is the set of all pairs (x, i) with x in U_i , and i takes on the values 1 and 2. We identify $U_1 \subseteq U_1 \sqcup U_2$ with the set of pairs $(x, 1)$ and $U_2 \subseteq U_1 \sqcup U_2$ with the set of pairs $(y, 2)$. A subset E of X is defined to be open if $E \cap U_1$ is open in U_1 and $E \cap U_2$ is open in U_2 . The resulting collection of open sets is a topology for X , and the embedded copies of U_1 and U_2 in X are open. We define $(x, 1) \sim (y, 2)$ if $x = y$ as members of \mathbb{R}^n , and the identification space is X/\sim . We give X/\sim the quotient topology, and it is not hard to see that X/\sim is homeomorphic to the union $U_1 \cup U_2$ as a topological subspace of the metric space \mathbb{R}^n .

Let us come to the general definition. We are given a set of topological spaces W_i for i in some nonempty index set I , and we assume, for each ordered pair (i, j) , that we have a homeomorphism ψ_{ji} of an open subset W_{ji} of W_i onto an open subset W_{ij} of W_j (possibly with W_{ji} and W_{ij} both empty) such that

- (i) ψ_{ii} is the identity on $W_{ii} = W_i$,
- (ii) $\psi_{ij} \circ \psi_{ji}$ is the identity on W_{ji} , and
- (iii) $W_{ki} \cap W_{ji} = \psi_{ij}(W_{kj} \cap W_{ij})$, and $\psi_{kj} \circ \psi_{ji} = \psi_{ki}$ on this set.

We form the disjoint union $X = \bigsqcup_i W_i$, i.e., the set of pairs (x, i) with x in W_i . We topologize X by requiring that each W_i be open in X . Then we introduce a relation \sim on X by saying that $(x, i) \sim (y, j)$ if $\psi_{ji}(x) = y$. The three properties (i), (ii), and (iii) show that \sim is an equivalence relation, and X/\sim is called an **identification space**. It is given the quotient topology.

Let us see the effect of this construction in the special case that we reconstruct a general smooth n -dimensional manifold out of an atlas of its charts. If κ_i is a chart in the atlas, we take W_i to be the image \tilde{M}_{κ_i} of κ_i . With two such charts κ_i and κ_j , define

$$W_{ji} = \kappa_i(\tilde{M}_{\kappa_i} \cap \tilde{M}_{\kappa_j}), \quad W_{ij} = \kappa_j(\tilde{M}_{\kappa_i} \cap \tilde{M}_{\kappa_j}), \quad \psi_{ji} = \kappa_j \circ \kappa_i^{-1}.$$

It is a routine matter to check (i), (ii), and (iii). The disjoint union $\bigsqcup_i \kappa_i^{-1}$ of the maps κ_i^{-1} is a continuous open function from $X = \bigsqcup_i W_i$ onto M . Let $q : X \rightarrow X/\sim$ be the quotient map. If $(x, i) \sim (y, j)$, then $\psi_{ji}(x) = y$ and

hence $\kappa_j \circ \kappa_i^{-1}(x) = y$ and $\kappa_i^{-1}(x) = \kappa_j^{-1}(y)$. Thus equivalent points in X map to the same point in M , and we obtain a factorization $\bigsqcup_i \kappa_i^{-1} = \varphi \circ q$ for a continuous open map $\varphi : X/\sim \rightarrow M$. Since the only identifications in M are the ones determined by the charts, i.e., the ones of the form $(x, i) \sim (y, j)$ as above, φ is one-one and consequently is a homeomorphism. We can recover the charts of M as well, since the restriction of q to a single W_i is one-one. The i^{th} chart is the function $q^{-1} \circ \varphi^{-1}|_{M_{\kappa_i}} : M_{\kappa_i} \rightarrow \tilde{M}_{\kappa_i}$.

Thus an identification space is a suitable device for reconstructing a smooth manifold from its charts. We can therefore try to use identification spaces to build new smooth manifolds out of what ought to be their charts. Proposition 8.11 below simplifies the checking of the Hausdorff condition. Proposition 8.12 shows, under natural additional assumptions, that the identification space is a smooth manifold if it has been shown to be Hausdorff.

Proposition 8.11. In the situation of an identification space formed from a disjoint union $X = \bigsqcup_i W_i$ and an equivalence relation \sim , the quotient mapping $q : X \rightarrow X/\sim$ is necessarily open. Consequently the identification space X/\sim is Hausdorff if and only if the set of equivalent pairs in $X \times X$ is closed.

REMARKS. In applications we may expect that the given topological spaces W_i are Hausdorff, and then their disjoint union X will be Hausdorff, and so will $X \times X$. In this case the theory of nets becomes a handy tool for deciding whether the set of equivalent pairs within $X \times X$ is closed. Thus suppose we have nets with $x_\alpha \sim y_\alpha$ in X and that $x_\alpha \rightarrow x_0$ and $y_\alpha \rightarrow y_0$. We are to prove that $x_0 \sim y_0$. Let x_0 be in W_i , and let y_0 be in W_j . Since W_i and W_j are open in X , x_α is eventually in W_i and y_α is eventually in W_j . In other words, the Hausdorff condition depends on only two sets W_i at a time and is as follows: We may assume that x_α and x_0 are in W_i with $x_\alpha \rightarrow x_0$, that y_α and y_0 are in W_j with $y_\alpha \rightarrow y_0$, and that $x_\alpha \sim y_\alpha$ for all α . What needs proof is that $x_0 \sim y_0$.

PROOF. The second statement follows from the first in view of Proposition 10.40 of *Basic*. Thus we have only to show that the quotient map is open. If U is open in X , we are to show that $q^{-1}(q(U))$ is open in X . The direct image of a function respects arbitrary unions, and thus $q(U) = \bigcup_j q(U \cap W_j)$. Hence $q^{-1}(q(U)) = \bigcup_j q^{-1}(q(U \cap W_j))$, and it is enough to prove that a single $q^{-1}(q(U \cap W_j))$ is open. Since X is the disjoint union of the open sets W_i , it is enough to prove that each $W_i \cap q^{-1}(q(U \cap W_j))$ is open. This intersection is the subset of elements in W_i that get identified with elements in $U \cap W_j$, namely $\psi_{ij}(U \cap W_{ij})$. Since ψ_{ij} is a homeomorphism of W_{ij} with W_{ji} , the set $\psi_{ij}(U \cap W_{ij})$ is open in W_{ji} . Since W_{ji} is open in W_i , $\psi_{ij}(U \cap W_{ij})$ is open in W_i . \square

Proposition 8.12. Let the topological space M be obtained as an identification space from a disjoint union $X = \bigsqcup_i W_i$ in which each W_i is an open subset of \mathbb{R}^n . Suppose that each identification $\psi_{ji} : W_{ji} \rightarrow W_{ij}$ is a smooth function, and suppose that $q : X \rightarrow M$ denotes the quotient mapping. Assume that the set of equivalent pairs in $X \times X$ is a closed subset, so that M is a Hausdorff space. Then M becomes a smooth n -dimensional manifold under the following definition of an atlas of compatible charts: For each i , let $U_i = q(W_i)$, and define $\kappa_i : U_i \rightarrow W_i$ to be the inverse of $q|_{W_i} : W_i \rightarrow U_i$. The charts of the atlas are the maps κ_i .

PROOF. The mapping q is open according to Proposition 8.11. Since W_i is open in X , $U_i = q(W_i)$ is open in M . To see that q is one-one from W_i to U_i , suppose that two members of W_i are equivalent. We know that the members of W_i are of the form (w, i) , and the equivalence relation is given by the statement

$$(w_i, i) \sim (w_j, j) \quad \text{if and only if} \quad \psi_{ji}(w_i) = w_j. \quad (*)$$

In particular w_i must be in the domain of ψ_{ji} , which is W_{ji} . Then two members of W_i , say (w, i) and (w', i) , can be equivalent only if $\psi_{ii}(w) = w'$. Since ψ_{ii} is the identity function, $w = w'$. Therefore q is one-one on W_i and is a homeomorphism of W_i onto the open subset U_i of M . Consequently κ_i is well defined as a homeomorphism of the open subset U_i of M with the open subset W_i of Euclidean space \mathbb{R}^n .

We have to check the compatibility of the charts. We have

$$\begin{aligned} U_i \cap U_j &= q(W_i) \cap q(W_j) \\ &= \{\text{classes of } \{q(w_i, i) \mid \psi_{ji} \text{ is defined on } w_i\}\} = q(W_{ji}). \end{aligned}$$

Then

$$\kappa_i(U_i \cap U_j) = \kappa_i((q|_{W_i})(W_{ji})) = W_{ji},$$

and similarly $\kappa_j(U_i \cap U_j) = W_{ij}$. Hence $\kappa_j \circ \kappa_i^{-1}$ carries W_{ji} onto W_{ij} . If (w_i, i) is a member of W_{ji} , we show that

$$\kappa_j(\kappa_i^{-1}((w_i, i))) = (\psi_{ji}(w_i), j). \quad (**)$$

If we drop the second entries of our pairs, which are present only to emphasize that X is a disjoint union, equation (**) says that $\kappa_j \circ \kappa_i^{-1}$ equals ψ_{ji} on W_{ji} . Since ψ_{ji} is smooth by assumption, the verification of (**) will therefore complete the proof of the proposition. Taking (*) into account, we have

$$\kappa_i^{-1}((w_i, i)) = q((w_i, i)) = q((\psi_{ji}(w_i), j)) = \kappa_j^{-1}((\psi_{ji}(w_i), j)).$$

Application of κ_j to both sides of this identity yields (**) and thus completes the proof. \square

4. Vector Bundles

In this section we introduce general vector bundles over a smooth manifold M . Of particular interest are the tangent and cotangent bundles. The tangent bundle as a set is to be identifiable with $\bigcup_{p \in M} T_p(M)$, and one realization of the cotangent bundle as a set will be the same kind of union of the dual vector spaces $T_p^*(M)$ to $T_p(M)$. To construct these bundles as manifolds, we shall form them as identification spaces in the sense of Section 3, and that step will be carried out in this section.

We continue with the convention of writing \mathbb{F} for the field of scalars, which is to be \mathbb{R} or \mathbb{C} . The fiber of any vector bundle will be \mathbb{F}^n for some n , and we speak of real and complex vector bundles in the two cases.

Let M be a smooth manifold of dimension m , and let $\{\kappa\}$ be an atlas of compatible charts, where κ is the map $\kappa : M_\kappa \rightarrow \tilde{M}_\kappa$. Denote by $GL(n, \mathbb{F})$ the general linear group of all n -by- n nonsingular matrices with entries in \mathbb{F} . A smooth **coordinate vector bundle** of **rank** n over M relative to this atlas consists of a smooth manifold B called the **bundle space**, a smooth mapping π of B onto M called the **projection** from the bundle space to the **base space** M , and diffeomorphisms $\phi_\kappa : M_\kappa \times \mathbb{F}^n \rightarrow \pi^{-1}(M_\kappa)$ called the **coordinate functions** such that

- (i) $\pi \phi_\kappa(p, v) = p$ for $p \in M_\kappa$ and $v \in \mathbb{F}^n$,
- (ii) the smooth maps $\phi_{\kappa, p} : \mathbb{F}^n \rightarrow \pi^{-1}(M_\kappa)$ defined for p in M_κ by $\phi_{\kappa, p}(v) = \phi_\kappa(p, v)$ are such that $\phi_{\kappa', p}^{-1} \circ \phi_{\kappa, p} : \mathbb{F}^n \rightarrow \mathbb{F}^n$ is in $GL(n, \mathbb{F})$ for each κ and κ' and for all p in $M_\kappa \cap M_{\kappa'}$,
- (iii) the map $g_{\kappa'\kappa} : M_\kappa \cap M_{\kappa'} \rightarrow GL(n, \mathbb{F})$ defined by $g_{\kappa'\kappa}(p) = \phi_{\kappa', p}^{-1} \circ \phi_{\kappa, p}$ is smooth.

The maps $p \mapsto g_{\kappa'\kappa}(p)$ will be called the **transition functions**⁵ of the coordinate vector bundle.

An atlas of compatible charts of the coordinate vector bundle may be taken to consist of the maps $(\kappa \times 1) \circ \phi_\kappa^{-1} : \pi^{-1}(M_\kappa) \rightarrow \tilde{M}_\kappa \times \mathbb{F}^n$. The dimension of B is $m + n$ if $\mathbb{F} = \mathbb{R}$ and is $m + 2n$ if $\mathbb{F} = \mathbb{C}$.

EXAMPLE. Data for the tangent bundle. Although we have not yet introduced the topology on the bundle space in this instance, we can identify the functions ϕ_κ , $\phi_{\kappa'}$, and $g_{\kappa'\kappa}$ explicitly. Let the local expressions for κ and κ' be $\kappa = (x_1, \dots, x_n)$ and $\kappa' = (y_1, \dots, y_n)$. Let $c = \begin{pmatrix} c_1 \\ \vdots \\ c_n \end{pmatrix}$ and $d = \begin{pmatrix} d_1 \\ \vdots \\ d_n \end{pmatrix}$ be members of \mathbb{F}^n . The set $\pi^{-1}(M_\kappa)$ is to consist of all tangent vectors at points of M_κ , and Proposition

⁵The terms **coordinate transformations** and **transition matrices** are used also.

8.5 shows that these are all expressions $\sum_{j=1}^n c_j \left[\frac{\partial}{\partial x_j} \right]_p$, where $\left[\frac{\partial f}{\partial x_j} \right]_p$ concretely means $\frac{\partial(f \circ \kappa^{-1})}{\partial u_j}(\kappa(p))$. The formulas for ϕ_κ and $\phi_{\kappa'}$ are then

$$\phi_{\kappa,p}(c) = \sum_{j=1}^n c_j \left[\frac{\partial}{\partial x_j} \right]_p$$

and

$$\phi_{\kappa',p}(d) = \sum_{j=1}^n d_j \left[\frac{\partial}{\partial y_j} \right]_p.$$

The other relevant formula is the formula for the matrix of the differential of a smooth mapping relative to compatible charts in the domain and range. The formula is given in Proposition 8.6 and is

$$dF_p \left(\left[\frac{\partial}{\partial x_j} \right]_p \right) = \sum_{i=1}^n \left[\frac{\partial F_i}{\partial x_j} \right]_p \left[\frac{\partial}{\partial y_i} \right]_p.$$

We apply this formula with F equal to the identity mapping, whose local expression is $\kappa' \circ \kappa^{-1}$ and therefore has $F_i = y_i \circ \kappa^{-1}$. Since the differential of the identity is the identity, we have

$$\left[\frac{\partial}{\partial x_j} \right]_p = \sum_{i=1}^n \left[\frac{\partial y_i}{\partial x_j} \right]_p \left[\frac{\partial}{\partial y_i} \right]_p.$$

Substituting into the formula for $\phi_{\kappa,p}(c)$, we obtain

$$\phi_{\kappa,p}(c) = \sum_{i=1}^n \left(\sum_{j=1}^n c_j \left[\frac{\partial y_i}{\partial x_j} \right]_p \right) \left[\frac{\partial}{\partial y_i} \right]_p.$$

Therefore $\phi_{\kappa',p}^{-1} \phi_{\kappa,p}(c) = d$, where $d_i = \sum_{j=1}^n c_j \left[\frac{\partial y_i}{\partial x_j} \right]_p = \left(\left[\frac{\partial y_i}{\partial x_j} \right]_p c \right)_i$, and we conclude that

$$g_{\kappa'\kappa}(p) = \left[\frac{\partial y_i}{\partial x_j} \right]_p.$$

Returning to case of a general coordinate vector bundle, let us observe a simple property of the transition functions.

Proposition 8.13. Let M be an m -dimensional smooth manifold M , fix an atlas $\{\kappa\}$ for M , and let $\pi : B \rightarrow M$ be a smooth vector bundle of rank n with transition functions $p \mapsto g_{\kappa'\kappa}(p)$. Then

$$g_{\kappa''\kappa'}(p)g_{\kappa'\kappa}(p) = g_{\kappa''\kappa}(p) \quad \text{for all } p \in M_\kappa \cap M_{\kappa'} \cap M_{\kappa''}.$$

Consequently the transition functions satisfy the identities $g_{\kappa\kappa}(p) = 1$ for $p \in M_\kappa$ and $g_{\kappa\kappa'}(p) = (g_{\kappa'\kappa}(p))^{-1}$ for $p \in M_\kappa \cap M_{\kappa'}$.

PROOF. We have $g_{\kappa''\kappa'}(p)g_{\kappa'\kappa}(p) = \phi_{\kappa'',p}^{-1} \phi_{\kappa',p} \phi_{\kappa',p}^{-1} \phi_{\kappa,p} = \phi_{\kappa'',p}^{-1} \phi_{\kappa,p} = g_{\kappa''\kappa}(p)$. Putting $\kappa = \kappa' = \kappa''$ yields $g_{\kappa\kappa}(p)g_{\kappa\kappa}(p) = g_{\kappa\kappa}(p)$; thus $g_{\kappa\kappa}(p) = 1$. Putting $\kappa = \kappa''$ yields $g_{\kappa\kappa'}(p)g_{\kappa'\kappa}(p) = g_{\kappa\kappa}(p) = 1$. \square

The main abstract result about vector bundles for our purposes will be a converse to Proposition 8.13, enabling us to construct a vector bundle from an atlas of M and a system of smooth functions $p \mapsto g_{\kappa'\kappa}(p)$ defined on $M_\kappa \cap M_{\kappa'}$ if these functions satisfy the conditions of the proposition. This result will be given as Proposition 8.14 below. In the case of the tangent bundle, we saw above that $g_{\kappa'\kappa}(p)$ is given by $g_{\kappa'\kappa}(p) = \left[\frac{\partial y_i}{\partial x_j} \right]_p$. The identity $g_{\kappa''\kappa'}(p)g_{\kappa'\kappa}(p) = g_{\kappa''\kappa}(p)$ follows from the chain rule, and thus the abstract result will complete the construction of the tangent bundle as a smooth manifold. We shall construct the cotangent bundle similarly.

One can equally construct other vector bundles of interest in analysis, as we shall see, but we shall omit the details for most of these. It is fairly clear from the example above that one can make local calculations with vector bundles by working with the transition functions. Here is an example.

EXAMPLE. Suppose for a particular coordinate vector bundle that we have a system of functions $f_\kappa : \tilde{M}_\kappa \times \mathbb{F}^n \rightarrow S$ with range equal to some set S independent of κ . Let us determine the circumstances under which the system $\{f_\kappa\}$ is the local form of some globally defined function $f : B \rightarrow S$. A necessary and sufficient condition is that whenever $(x, v) \in \tilde{M}_\kappa \times \mathbb{F}^n$ and $(y, v') \in \tilde{M}_{\kappa'} \times \mathbb{F}^n$ correspond to the same point of B , then $f_\kappa(x, v) = f_{\kappa'}(y, v')$. The maps from $\tilde{M}_\kappa \times \mathbb{F}^n$ and $\tilde{M}_{\kappa'} \times \mathbb{F}^n$ into B are $\phi_\kappa \circ (\kappa^{-1} \times 1)$ and $\phi_{\kappa'} \circ (\kappa'^{-1} \times 1)$. Thus (x, v) and (y, v') correspond to the same member of B if and only if $\phi_\kappa(\kappa^{-1}x, v) = \phi_{\kappa'}(\kappa'^{-1}y, v')$. We must have $\kappa^{-1}x = \kappa'^{-1}y$ for this equality. In this case let us put $p = \kappa^{-1}x = \kappa'^{-1}y$, and then it is necessary and sufficient that $\phi_{\kappa,p}(v) = \phi_{\kappa',p}(v')$, hence that $\phi_{\kappa',p}^{-1} \circ \phi_{\kappa,p}(v) = v'$, hence that $g_{\kappa'\kappa}(p)(v) = v'$. Thus (x, v) and (y, v') correspond to the same point in B if and only if $y = \kappa'\kappa^{-1}x$ and $g_{\kappa'\kappa}(\kappa^{-1}x)(v) = v'$. Consequently the functions f_κ define a global f if and only if

$$\boxed{f_\kappa(x, v) = f_{\kappa'}(\kappa'\kappa^{-1}x, g_{\kappa'\kappa}(\kappa^{-1}x)(v))}$$

whenever $\kappa'\kappa^{-1}x$ is defined. In the case of the tangent bundle, we saw in the previous example that $g_{\kappa'\kappa} = \left[\frac{\partial y_i(x)}{\partial x_j} \right]$. Thus the condition is that

$$f_\kappa(x, v) = f_{\kappa'}\left(y, \left[\frac{\partial y_i(x)}{\partial x_j} \right](v)\right)$$

whenever $y = \kappa'\kappa^{-1}(x)$; here the fiber dimension n is also the dimension of the base manifold M .

Before getting to the converse result to Proposition 8.13, let us address the question of when, for given n , \mathbb{F} , M , B , and π , we get the “same” coordinate

vector bundle from a different but compatible atlas $\{\lambda\}$ and different coordinate functions ϕ_λ . The condition that we impose, which is called **strict equivalence**, is that if we set up the transition functions corresponding to a member κ of the first atlas and a member λ of the second atlas, namely

$$\bar{g}_{\lambda\kappa}(p) = \phi'_{\lambda,p}{}^{-1} \circ \phi_{\kappa,p} \quad \text{for } p \in M_\kappa \cap M_\lambda,$$

then each $\bar{g}_{\lambda\kappa}(p)$ lies in $GL(n, \mathbb{F})$ and the function $p \mapsto \bar{g}_{\lambda\kappa}(p)$ is smooth from $M_\kappa \cap M_\lambda$ into $GL(n, \mathbb{F})$. In other words, strict equivalence means that the union of the two atlases, along with the associated data, is to make $\pi : B \rightarrow M$ into a coordinate vector bundle. Strict equivalence is certainly reflexive and symmetric. Since we can discard some charts from the construction of a coordinate vector bundle as long as the remaining charts cover M , strict equivalence is transitive. An equivalence class of strictly equivalent coordinate vector bundles is called a **vector bundle**, real or complex according as \mathbb{F} is \mathbb{R} or \mathbb{C} .

With the definition of smooth structure for a smooth manifold, we were able to make the atlas canonical by assuming that it was maximal. Every atlas of compatible charts could be extended to one and only one maximal such atlas, and therefore smooth manifolds were determined by specifying any atlas of compatible charts, not necessarily a maximal one. We do not have to address the corresponding question about vector bundles—whether the atlas of M used in defining a coordinate vector bundle can be enlarged to a maximal atlas of M and still define a coordinate vector bundle. The reason is that the specific vector bundles with which we work are all definable immediately by maximal atlases of M .

Now let us proceed with the converse result.

Proposition 8.14. If a smooth m -dimensional manifold M is given, along with an atlas $\{\kappa\}$ of compatible charts and a system of smooth functions $g_{\kappa'\kappa} : M_\kappa \cap M_{\kappa'} \rightarrow GL(n, \mathbb{F})$ satisfying the property $g_{\kappa''\kappa'}(p)g_{\kappa'\kappa}(p) = g_{\kappa''\kappa}(p)$ for all p in $M_\kappa \cap M_{\kappa'} \cap M_{\kappa''}$, then there exists a coordinate vector bundle $\pi : B \rightarrow M$ with the functions $g_{\kappa'\kappa}$ as transition functions. The result is unique in the following sense: if $\pi : B \rightarrow M$ and $\pi' : B' \rightarrow M$ are two such coordinate vector bundles, with coordinate functions ϕ_κ and $\phi'_{\kappa'}$, then there exists a diffeomorphism $h : B \rightarrow B'$ such that $\pi' \circ h = \pi$ and $\phi'_{\kappa'} = h \circ \phi_\kappa$ for all charts κ in the atlas.

PROOF OF UNIQUENESS OF COORDINATE VECTOR BUNDLE UP TO FUNCTION h . Define a diffeomorphism $h_\kappa : \pi^{-1}(M_\kappa) \rightarrow \pi'^{-1}(M_\kappa)$ by $h_\kappa = \phi'_{\kappa'} \circ \phi_\kappa^{-1}$, so that $h_\kappa \circ \phi_\kappa = \phi'_{\kappa'}$. Evaluating both sides at (p, \mathbb{F}^n) with p in M_κ , we obtain $h_\kappa(\pi^{-1}(p)) = \pi'^{-1}(p)$. Thus $\pi' \circ h_\kappa = \pi$ on $\pi^{-1}(M_\kappa)$.

Since the map $h_{\kappa,p} = h_\kappa|_{\pi^{-1}(p)}$ carries $\pi^{-1}(p)$ to $\pi'^{-1}(p)$, we can write $h_{\kappa,p} \circ \phi_{\kappa,p} = \phi'_{\kappa',p}$. If p is also in $M_{\kappa'}$, then we have $h_{\kappa',p} \circ \phi_{\kappa',p} = \phi'_{\kappa',p}$

as well. Since B and B' are assumed to have the same transition functions, $g_{\kappa'\kappa}(p) = \phi_{\kappa',p}^{-1}\phi_{\kappa,p} = \phi_{\kappa',p}'^{-1}\phi_{\kappa,p}'$; in other words, $\phi_{\kappa',p}g_{\kappa'\kappa}(p) = \phi_{\kappa,p}$ and $\phi_{\kappa',p}'g_{\kappa'\kappa}(p) = \phi_{\kappa,p}'$. Therefore

$$h_{\kappa,p}\phi_{\kappa,p} = \phi_{\kappa,p}' = \phi_{\kappa',p}'g_{\kappa'\kappa}(p) = h_{\kappa',p}\phi_{\kappa',p}g_{\kappa'\kappa}(p) = h_{\kappa',p}\phi_{\kappa,p},$$

and we obtain $h_{\kappa,p} = h_{\kappa',p}$. Thus the functions h_κ are consistently defined on their common domains and fit together as a global diffeomorphism of B onto B' . \square

PROOF OF EXISTENCE OF COORDINATE VECTOR BUNDLE. Let us construct B as an identification space. We are writing \tilde{M}_κ for $\kappa(M_\kappa)$, and we put $\tilde{M}_{\kappa'\kappa} = \kappa(M_\kappa \cap M_{\kappa'})$. Define $W_\kappa = \tilde{M}_\kappa \times \mathbb{F}^n$ and $W_{\kappa'\kappa} = \tilde{M}_{\kappa'\kappa} \times \mathbb{F}^n$, and let

$$\psi_{\kappa'\kappa}(\tilde{m}, v) = (\kappa'\kappa^{-1}(\tilde{m}), g_{\kappa'\kappa}(\kappa^{-1}(\tilde{m}))(v)) \quad \text{for } (\tilde{m}, v) \in W_{\kappa'\kappa}.$$

We shall prove that $X = \bigsqcup_\kappa W_\kappa$, together with the functions $\psi_{\kappa'\kappa}$, defines an identification space $B = X/\sim$. We have to check (i), (ii), and (iii) in Section 3. For (i), we need that $\psi_{\kappa\kappa}$ is the identity on $W_{\kappa\kappa} = W_\kappa$, and the computation is

$$\psi_{\kappa\kappa}(\tilde{m}, v) = (\tilde{m}, g_{\kappa\kappa}(\kappa^{-1}(\tilde{m}))(v)) = (\tilde{m}, v)$$

since $g_{\kappa\kappa}(\cdot)$ is identically the identity matrix. For (ii), we need that $\psi_{\kappa\kappa'}\psi_{\kappa'\kappa}$ is the identity on $W_{\kappa'\kappa}$. The composition on (\tilde{m}, v) is

$$\begin{aligned} \psi_{\kappa\kappa'}(\kappa'\kappa^{-1}(\tilde{m}), g_{\kappa'\kappa}(\kappa^{-1}(\tilde{m}))(v)) \\ &= (\kappa\kappa'^{-1}\kappa'\kappa^{-1}(\tilde{m}), g_{\kappa\kappa'}(\kappa'^{-1}(\kappa'\kappa^{-1}(\tilde{m})))g_{\kappa'\kappa}(\kappa^{-1}(\tilde{m}))(v)) \\ &= (\tilde{m}, g_{\kappa\kappa'}(\kappa^{-1}(\tilde{m}))g_{\kappa'\kappa}(\kappa^{-1}(\tilde{m}))(v)). \end{aligned}$$

The second member of the right side collapses to v since $g_{\kappa\kappa'}(p)g_{\kappa'\kappa}(p) = 1$ for all p in M_κ . This proves (ii). For (iii), we need that $\psi_{\kappa''\kappa'} \circ \psi_{\kappa'\kappa} = \psi_{\kappa''\kappa}$ on the set $W_{\kappa''\kappa} \cap W_{\kappa'\kappa} = \psi_{\kappa\kappa'}(W_{\kappa''\kappa'} \cap W_{\kappa\kappa'})$, and the composition on (\tilde{m}, v)

$$\begin{aligned} &= \psi_{\kappa''\kappa'}(\kappa'\kappa^{-1}(\tilde{m}), g_{\kappa'\kappa}(\kappa^{-1}(\tilde{m}))(v)) \\ &= (\kappa''\kappa'^{-1}(\kappa'\kappa^{-1}(\tilde{m})), g_{\kappa''\kappa'}(\kappa'^{-1}(\kappa'\kappa^{-1}(\tilde{m})))g_{\kappa'\kappa}(\kappa^{-1}(\tilde{m}))(v)) \\ &= (\kappa''\kappa^{-1}(\tilde{m}), g_{\kappa''\kappa'}(\kappa^{-1}(\tilde{m}))g_{\kappa'\kappa}(\kappa^{-1}(\tilde{m}))(v)) \\ &= (\kappa''\kappa^{-1}(\tilde{m}), g_{\kappa''\kappa}(\kappa^{-1}(\tilde{m}))(v)) \\ &= \psi_{\kappa''\kappa}(\tilde{m}, v). \end{aligned}$$

This proves (iii) and completes the construction of B .

To prove that B is Hausdorff, we apply Proposition 8.11 and its remark. Thus suppose that we have nets with $x_\alpha \sim y_\alpha$ in X , that $x_\alpha \rightarrow x_0$ and $y_\alpha \rightarrow y_0$, and that x_α and x_0 are in W_κ and y_α and y_0 are in $W_{\kappa'}$. We are to prove that $x_0 \sim y_0$. Write $x_\alpha = (\tilde{m}_\alpha, v_\alpha)$, $x_0 = (\tilde{m}_0, v_0)$, $y_\alpha = (\tilde{m}'_\alpha, v'_\alpha)$, and $y_0 = (\tilde{m}'_0, v'_0)$. The assumed convergence says that $\tilde{m}_\alpha \rightarrow \tilde{m}_0$, $v_\alpha \rightarrow v_0$, $\tilde{m}'_\alpha \rightarrow \tilde{m}'_0$, and $v'_\alpha \rightarrow v'_0$. The assumed equivalence $x_\alpha \sim y_\alpha$ says that $\psi_{\kappa'\kappa}(\tilde{m}_\alpha, v_\alpha) = (\tilde{m}'_\alpha, v'_\alpha)$, i.e.,

$$\kappa'\kappa^{-1}(\tilde{m}_\alpha) = \tilde{m}'_\alpha \quad \text{and} \quad g_{\kappa'\kappa}(\kappa^{-1}(\tilde{m}_\alpha))(v_\alpha) = v'_\alpha,$$

and we are to prove that

$$\kappa'\kappa^{-1}(\tilde{m}_0) = \tilde{m}'_0 \quad \text{and} \quad g_{\kappa'\kappa}(\kappa^{-1}(\tilde{m}_0))(v_0) = v'_0.$$

The functions $\kappa'\kappa^{-1}$, $g_{\kappa'\kappa}$, and κ^{-1} are continuous, and the only question is whether \tilde{m}_0 is in the domain of $\kappa'\kappa^{-1}$ and $\kappa^{-1}(\tilde{m}_0)$ is in the domain of $g_{\kappa'\kappa}$, i.e., whether \tilde{m}_0 is in the subset $\tilde{M}_{\kappa'\kappa} = \kappa(M_\kappa \cap M_{\kappa'})$ of $\tilde{M}_\kappa = \kappa(M_\kappa)$. Assume the contrary. Then \tilde{m}_0 is on the boundary of $\kappa(M_\kappa \cap M_{\kappa'})$ in $\kappa(M_\kappa)$ and \tilde{m}'_0 is on the boundary of $\kappa'(M_\kappa \cap M_{\kappa'})$ in $\kappa'(M_{\kappa'})$. So $\kappa^{-1}(\tilde{m}_0)$ is on the boundary of $M_\kappa \cap M_{\kappa'}$ in M_κ , and $\kappa'^{-1}(\tilde{m}'_0)$ is on the boundary of $M_\kappa \cap M_{\kappa'}$ in $M_{\kappa'}$. This implies that $\kappa^{-1}(\tilde{m}_0)$ is in M_κ but not $M_{\kappa'}$ while $\kappa'^{-1}(\tilde{m}'_0)$ is in $M_{\kappa'}$ but not M_κ . Consequently $\kappa^{-1}(\tilde{m}_0) \neq \kappa'^{-1}(\tilde{m}'_0)$. Since M is Hausdorff, we can find disjoint open neighborhoods V and V' of $\kappa^{-1}(\tilde{m}_0)$ and $\kappa'^{-1}(\tilde{m}'_0)$ in M . Since κ^{-1} is continuous, $\kappa^{-1}(\tilde{m}_\alpha)$ is eventually in V ; since κ'^{-1} is continuous, $\kappa'^{-1}(\tilde{m}'_\alpha)$ is eventually in V' . Then we cannot have $\kappa^{-1}(\tilde{m}_\alpha) = \kappa'^{-1}(\tilde{m}'_\alpha)$ eventually, hence cannot have $\kappa'\kappa^{-1}(\tilde{m}_\alpha) = \tilde{m}'_\alpha$ eventually, contradiction. We conclude that B is Hausdorff.

To complete the proof, we exhibit B as a coordinate vector bundle. Let $q : X \rightarrow B$ be the quotient map. Application of Proposition 8.12 produces a manifold structure on B , the charts being of the form $\kappa^\# = (q|_{W_\kappa})^{-1}$ with domain $q(W_\kappa)$. If p_κ denotes the projection of W_κ on \tilde{M}_κ , we define $\pi : q(W_\kappa) \rightarrow M$ to be the composition $\kappa^{-1}p_\kappa\kappa^\#$. To have $\pi : B \rightarrow M$ be globally defined, we have to check consistency from chart to chart. Thus suppose that $b = q(w_\kappa) = q(w_{\kappa'})$ with $w_\kappa = (\tilde{m}_\kappa, v_\kappa)$ in W_κ and $w_{\kappa'} = (\tilde{m}_{\kappa'}, v_{\kappa'})$ in $W_{\kappa'}$. We are to check that $\kappa^{-1}p_\kappa(w_\kappa) = \kappa'^{-1}p_{\kappa'}(w_{\kappa'})$, hence that $\kappa^{-1}(\tilde{m}_\kappa) = \kappa'^{-1}(\tilde{m}_{\kappa'})$. The condition $q(w_\kappa) = q(w_{\kappa'})$ means that $w_\kappa \sim w_{\kappa'}$, which means that $\psi_{\kappa'\kappa}(w_\kappa) = w_{\kappa'}$ and therefore that $(\kappa'\kappa^{-1}(\tilde{m}_\kappa), g_{\kappa'\kappa}(\kappa^{-1}(\tilde{m}_\kappa))(v_\kappa)) = (\tilde{m}_{\kappa'}, v_{\kappa'})$. Examining the first entries shows that $\kappa^{-1}(\tilde{m}_\kappa) = \kappa'^{-1}(\tilde{m}_{\kappa'})$. Therefore π is well defined.

The diffeomorphism $\phi_\kappa : M_\kappa \times \mathbb{F}^n \rightarrow \pi^{-1}(M_\kappa)$ is given by $\phi_\kappa = q \circ (\kappa \times 1)$. If p is in $M_\kappa \cap M_{\kappa'}$, write $v' = \phi_{\kappa',p}^{-1}(\phi_{\kappa,p}(v))$. Then $\phi_{\kappa',p}(v') = \phi_{\kappa,p}(v)$, and hence $q(\kappa'(p), v') = q(\kappa(p), v)$. Thus $(\kappa'(p), v') \sim (\kappa(p), v)$, and

$$(\kappa'(p), v') = \psi_{\kappa'\kappa}(\kappa(p), v) = (\kappa'\kappa^{-1}(\kappa(p)), g_{\kappa'\kappa}(\kappa^{-1}(\kappa(p)))(v)).$$

Examining the equality of the second coordinates, we see that $v' = g_{\kappa'\kappa}(p)(v)$. Therefore $\phi_{\kappa',p}^{-1} \circ \phi_{\kappa,p} = g_{\kappa'\kappa}(p)$, and the transition functions match the given functions. This completes the proof. \square

As we mentioned after Proposition 8.13, Proposition 8.14 enables us to introduce the structure of a vector bundle on the **tangent bundle** $T(M)$, since the product formula for the transition functions $g_{\kappa'\kappa}(p) = \left[\frac{\partial y_i}{\partial x_j}\right]_p$ follows from the chain rule. The transition functions $g_{\kappa'\kappa}(p) = \left[\frac{\partial y_i}{\partial x_j}\right]_p$ are real-valued and thus can be regarded as in $GL(n, \mathbb{R})$ or $GL(n, \mathbb{C})$. Thus $T(M)$, in our construction, can be regarded as having fiber \mathbb{R}^n or \mathbb{C}^n , whichever is more convenient in a particular context. We can speak of the **real tangent bundle** $T(M, \mathbb{R})$ and the **complex tangent bundle** $T(M, \mathbb{C})$ in the two cases.⁶

We shall make use also of the **cotangent bundle** $T^*(M)$, and again we shall allow this to be real or complex. Members of the cotangent bundle will be called **cotangent vectors**. We give two slightly different realizations of $T^*(M)$, one starting from $T(M)$ as the object of primary interest and the other proceeding directly to $T^*(M)$. In both cases, $T^*(M)$ and $T(M)$ will be fiber-by-fiber duals of one another, and the transition functions will be transpose inverses of one another.

For the first construction we shall identify the dual of $T_p(M)$ in terms of differentials as defined in Section 1. Let M be n -dimensional, let κ be a compatible chart about p , and let $f \in C^\infty(U)$ be a smooth function in a neighborhood of p . By definition from Section 1, the differential $(df)_p$ is the linear function $(df)_p : T_p(M) \rightarrow T_{f(p)}(\mathbb{F})$ given by

$$(df)_p(L)(g) = L(g \circ f).$$

Let us take $g_0 : \mathbb{F} \rightarrow \mathbb{F}$ to be the function $g_0(t) = t$. Since

$$(df)_p\left[\frac{\partial}{\partial x_j}\right]_p(g_0) = \frac{\partial(g_0 \circ f)}{\partial x_j}(p) = g'_0(f(p)) \frac{\partial f}{\partial x_j}(p) = \frac{\partial f}{\partial x_j}(p),$$

we see that $(df)_p(L)(g_0) = Lf$ for all L in $T_p(M)$. In particular, each differential $(df)_p$ acts as a linear functional on $T_p(M)$. Moreover, the elements $(dx_i)_p$, namely the differentials for $f = x_i$, are the members of the dual basis to the basis $\left[\frac{\partial}{\partial x_j}\right]_p$ of $T_p(M)$, and we can use them to write

$$(df)_p = \sum_{i=1}^n \frac{\partial f}{\partial x_i}(p) (dx_i)_p.$$

We postpone a discussion of the bundle structure on $T^*(M)$ until after the second construction.

⁶Traditionally the words ‘‘tangent bundle’’ refer to what is being called the real tangent bundle, and the traditional notation for it is $T(M)$.

For the second construction we use the algebra \mathcal{C}_p of germs at p . Evaluation at p is well defined on germs at p , and we let \mathcal{C}_p^0 be the vector subspace of germs whose value at p is 0. Inside \mathcal{C}_p^0 , we wish to identify the vector subspace \mathcal{C}_p^1 of germs that vanish at least to second order at p . These are⁷ germs of functions f with the property that $|f(q) - f(p)|$ is dominated by a multiple of $|\kappa(q) - \kappa(p)|^2$ in any chart κ about p when q is in a sufficiently small neighborhood of p .

Within the second construction the cotangent space $T_p^*(M)$ is defined as the vector space quotient $\mathcal{C}_p^0/\mathcal{C}_p^1$. To introduce a vector-bundle structure on $T^*(M) = \bigcup_p T_p^*(M)$ by means of Proposition 8.14, we need to set up the local expression for a member of the cotangent space and understand how it changes when we pass from one compatible chart κ to another κ' . We begin by observing for any open neighborhood U of p that there is a well-defined linear map $f \mapsto df(p)$ of $C^\infty(U)$ onto $T_p^*(M)$ given by passing from f to $f - f(p)$ in \mathcal{C}_p^0 and then to the coset representative of $f - f(p)$ in $T_p^*(M) = \mathcal{C}_p^0/\mathcal{C}_p^1$.

Proposition 8.15. Let M be a smooth manifold of dimension n , let p be in M , and let $\kappa = (x_1, \dots, x_n)$ be a compatible chart about p . In either construction of $T_p^*(M)$, the n quantities $dx_i(p)$ form a vector-space basis of $T_p^*(M)$, and any smooth function f defined in a neighborhood of p has

$$df(p) = \sum_{i=1}^n \frac{\partial f}{\partial x_i}(p) dx_i(p).$$

PROOF. We have already obtained this formula for the first construction. For the second construction, we observe as in the proof of Proposition 8.5 that Taylor's Theorem yields an expansion for f in the chart κ about p as

$$\begin{aligned} f(q) &= f(p) + \sum_{i=1}^n (x_i(q) - x_i(p)) \frac{\partial f}{\partial x_i}(p) \\ &\quad + \sum_{i,j} (x_i(q) - x_i(p))(x_j(q) - x_j(p)) r_{ij}(q), \end{aligned}$$

from which we obtain

$$df(p) = \sum_{i=1}^n \frac{\partial f}{\partial x_i}(p) dx_i(p).$$

This establishes the asserted expansion and shows that the $dx_i(p)$ span the vector space $T_p^*(M)$. For the linear independence suppose that $\sum_{i=1}^n c_i dx_i(p) = 0$ with

⁷If we allow ourselves to peek momentarily at the tangent space, we see that \mathcal{C}_p^1 is the subspace of all members of \mathcal{C}_p^0 on which all tangent vectors at p vanish.

the constants c_i not all 0. If we define $f = \sum_{i=1}^n c_i x_i$ in M_κ , then computation gives $\frac{\partial f}{\partial x_i}(p) = c_i$ and hence $df(p) = \sum_{i=1}^n c_i dx_i(p) = 0$. Thus $f - f(p)$ vanishes at least to order 2 at p . Since $f - f(p)$ is linear, we conclude that $f - f(p)$ vanishes identically near p . Hence all coefficients c_i are 0. This proves the linear independence. \square

When p moves within the compatible chart κ , we can express all members of the spaces $T_q^*(M)$ for q in that neighborhood as $\sum_{i=1}^n \xi_i(q) dx_i(q)$, but the functions $\xi_i(q)$ need not always be of the form $\frac{\partial f}{\partial x_i}(q)$ for a single function f . Nevertheless, we can use the transformation properties of $df(p)$ for special f 's to introduce a natural vector-bundle structure on $T^*(M)$ by means of Proposition 8.14.

EXAMPLE. Direct construction of bundle structure on cotangent bundle. Continuing with the direct analysis of $T^*(M)$, let us form the coordinate functions and charts. Define $T^*(M_\kappa) = \bigcup_{p \in M_\kappa} T_p^*(M)$. Using Proposition 8.15, we associate to a member (p, ξ) of $T^*(M_\kappa)$ the coordinates

$$(x_1(p), \dots, x_n(p); \xi_1, \dots, \xi_n),$$

where $\kappa(p) = (x_1(p), \dots, x_n(p))$ and $\xi = \sum_{i=1}^n \xi_i dx_i(p)$. The coordinate function ϕ_κ is given in this notation as a composition carrying $(p; \xi_1, \dots, \xi_n)$ first to $(x_1(p), \dots, x_n(p); \xi_1, \dots, \xi_n)$ and then to $\sum_{i=1}^n \xi_i dx_i(p)$. That is,

$$\phi_\kappa(p; \xi_1, \dots, \xi_n) = \sum_{i=1}^n \xi_i dx_i(p).$$

If p lies in another chart $\kappa' = (y_1, \dots, y_n)$, then we similarly have

$$\phi_{\kappa'}(p; \eta_1, \dots, \eta_n) = \sum_{i=1}^n \eta_i dy_i(p).$$

The formula of Proposition 8.15 shows that

$$dx_i(p) = \sum_{j=1}^n \frac{\partial x_i}{\partial y_j}(p) dy_j(p).$$

Therefore

$$\phi_\kappa(p; \xi_1, \dots, \xi_n) = \sum_{i=1}^n \xi_i dx_i(p) = \sum_{j=1}^n \left(\sum_{i=1}^n \xi_i \frac{\partial x_i}{\partial y_j}(p) \right) dy_j(p),$$

and

$$\phi_{\kappa'}^{-1} \phi_{\kappa}(p; \xi_1, \dots, \xi_n) = \left(p; \sum_{i=1}^n \xi_i \frac{\partial x_i}{\partial y_1}(p), \dots, \sum_{i=1}^n \xi_i \frac{\partial x_i}{\partial y_n}(p) \right).$$

In other words,

$$\phi_{\kappa'}^{-1} \phi_{\kappa}(p; \xi_1, \dots, \xi_n) = (p; \eta_1, \dots, \eta_n)$$

with $\eta_j = \sum_{i=1}^n \xi_i \frac{\partial x_i}{\partial y_j}(p)$. This says that the row vector $(\eta_1 \ \cdots \ \eta_n)$ is the product of the row vector $(\xi_1 \ \cdots \ \xi_n)$ by the matrix $\left[\frac{\partial x_i}{\partial y_j}(p) \right]$. Taking the transpose of this matrix equation, we see that the transition functions for the cotangent bundle are to be

$$g_{\kappa'\kappa}(p) = \left[\frac{\partial x_i}{\partial y_j}(p) \right]^{\text{tr}},$$

i.e., the transpose inverses of the transition functions for the tangent bundle. In view of the boxed formula earlier in this section, a system of functions $f_{\kappa} : \tilde{M}_{\kappa} \times \mathbb{F}^n \rightarrow S$ arises from a globally defined function on the cotangent bundle if and only if

$$f_{\kappa}(x, \xi) = f_{\kappa'}(y(x), \left[\frac{\partial x_i(y)}{\partial y_j} \right]^{\text{tr}}(\xi)),$$

i.e., if and only if

$$f_{\kappa}(x(y), \left(\left[\frac{\partial x_i(y)}{\partial y_j} \right]^{-1} \right)^{\text{tr}}(\eta)) = f_{\kappa'}(y, \eta).$$

If $\pi : B \rightarrow M$ is a smooth vector bundle, a **section** of B is a function $s : M \rightarrow B$ such that $\pi(s(p)) = p$ for all $p \in M$, and the section is a **smooth section** if s is smooth as a function between smooth manifolds.

Proposition 8.16. Let $\pi : B \rightarrow M$ be a smooth vector bundle of rank n , let $s : M \rightarrow B$ be a section, and let κ be a compatible chart for M . Then the coordinate function ϕ_{κ} has the property that $\phi_{\kappa}^{-1} \circ s(p) = (p, v_{\kappa}(p))$ for p in M_{κ} and for a function $v_{\kappa}(\cdot) : M_{\kappa} \rightarrow \mathbb{F}^n$. Moreover, the section s is smooth if and only if the function $p \mapsto v_{\kappa}(p)$ is smooth for every chart κ in an atlas.

PROOF. Let $P_{\kappa} : M_{\kappa} \times \mathbb{F}^n \rightarrow M_{\kappa}$ be projection to the first coordinate. Let us check that $P_{\kappa} \circ \phi_{\kappa}^{-1} = \pi$ on $\pi^{-1}(M_{\kappa})$. Suppose that p is in M_{κ} and $\phi_{\kappa}(p, v) = b$. Applying π gives $\pi(b) = \pi \phi_{\kappa}(p, v) = p$ by the defining property (i) of ϕ_{κ} . Therefore $\phi_{\kappa}^{-1}(b) = (p, v)$ and $P_{\kappa} \phi_{\kappa}^{-1}(b) = p = \pi(b)$. Since b is arbitrary in $\pi^{-1}(M_{\kappa})$, $P_{\kappa} \circ \phi_{\kappa}^{-1} = \pi$.

For a section s , the condition $\pi \circ s = 1$ on M therefore implies that $P_{\kappa} \circ \phi_{\kappa}^{-1} \circ s = 1$ on M_{κ} . Hence $\phi_{\kappa}^{-1} \circ s(p) = (p, v_{\kappa}(p))$ for p in M_{κ} and for some function $v_{\kappa} : M_{\kappa} \rightarrow \mathbb{F}^n$. Since each $\phi_{\kappa} : M_{\kappa} \times \mathbb{F}^n \rightarrow \pi^{-1}(M_{\kappa})$ is a diffeomorphism, s is smooth if and only if each function $\phi_{\kappa}^{-1} \circ s$ is smooth for κ in an atlas, and this condition holds if and only if each v_{κ} is smooth. \square

EXAMPLES.

(1) Vector fields. A **vector field** on M is a section of the tangent bundle. In the first example in this section, we obtained the formula $\phi_\kappa(p, v) = \sum_{i=1}^n v_i \left[\frac{\partial}{\partial x_i} \right]_p$ if p is in M_κ and $v = (v_1, \dots, v_n)$. Applying ϕ_κ to the formula of Proposition 8.16, we see that $s(p) = \phi_\kappa(p, v(p)) = \sum_{i=1}^n v_i(p) \left[\frac{\partial}{\partial x_i} \right]_p$ if the function $v(p)$ is $(v_1(p), \dots, v_n(p))$. On the other hand, Proposition 8.8 shows that any vector field X acts by $Xf(p) = \sum_{i=1}^n \frac{\partial f}{\partial x_i}(p)(Xx_i)(p)$. If we regard X as our section s , we see therefore that $v_i(p) = (Xx_i)(p)$. Since s is smooth if and only if all $v_i(p)$ are smooth, s is smooth if and only if all $(Xx_i)(p)$ are smooth. In view of Proposition 8.8, we conclude that a vector field is smooth as a section if and only if it is smooth in the sense of Section 2.

(2) Differential 1-forms. A **differential 1-form** on M is a section of the cotangent bundle. Just before Proposition 8.16 we obtained the formula $\phi_\kappa(p, \xi) = \sum_{i=1}^n \xi_i dx_i(p)$ if p is in M_κ and $\xi = (\xi_1, \dots, \xi_n)$. Applying ϕ_κ to the formula of Proposition 8.16, we see that $s(p) = \phi_\kappa(p, \xi(p)) = \sum_{i=1}^n \xi_i(p) dx_i(p)$ if the function $\xi(p)$ is $(\xi_1(p), \dots, \xi_n(p))$. Proposition 8.16 shows that s is smooth if and only if all the $\xi_i(p)$ are smooth, and thus a differential 1-form is smooth if and only if in each of its local expressions $\sum_{i=1}^n \xi_i(p) dx_i(p)$, all the coefficient functions $\xi_i(p)$ are smooth. In particular Proposition 8.15 gives the formula $df(p) = \sum_{i=1}^n \frac{\partial f}{\partial x_i}(p) dx_i(p)$ whenever f is a smooth function on M_κ , and therefore df is a smooth differential 1-form on M whenever f is in $C^\infty(M)$.

5. Distributions and Differential Operators on Manifolds

The goal of Sections 5–7 is to describe the framework for extending the method of pseudodifferential operators, as introduced in Section VII.6, from open subsets of Euclidean space to smooth manifolds. Just as in Section VII.6 a number of lengthy verifications are involved, and we omit them.

Several sources of examples with $\mathbb{F} = \mathbb{R}$ are worth mentioning. All of them come about in the context of some smooth manifold with some additional structure. All of them involve differential operators, as opposed to general pseudodifferential operators, at least initially. From this point of view, the reason

for introducing pseudodifferential operators is to have tools for working with differential operators.

The first source is the subject of “Lie groups.” A **Lie group** G is a smooth manifold that is a group in such a way that multiplication and inversion are smooth functions. Closed subgroups of $GL(n, \mathbb{F})$ furnish examples, but not in an obvious way. In any event, if a tangent vector at the identity is moved to arbitrary points of G by the differentials of the right translations of G , the result is a vector field that can be shown to be smooth and to have an invariance property relative to left translation. We can regard this left-invariant vector field as a first-order differential operator on G . Out of such operators we can form further differential operators by forming compositions, sums, and so on.

A related and larger source is quotient spaces of Lie groups. Any Lie group G is a locally compact group in the sense of Chapter VI. If H is a closed subgroup, then the quotient G/H turns out to have a smooth structure such that the group action $G \times G/H \rightarrow G/H$ is smooth. The quotient G/H may admit differential operators that are invariant under the action of G . For example the Laplacian makes sense on the unit sphere S^{n-1} and is invariant under rotations. The sphere S^{n-1} is the quotient of rotation groups $SO(n)/SO(n-1)$, and thus the Laplacian on the sphere falls into the category of an invariant differential operator on a quotient space of a Lie group.

A third source, overlapping some with the previous two, is Riemannian geometry. A **Riemannian manifold** M is a smooth manifold with an inner product specified on each tangent space $T_p(M)$ so as to vary smoothly with p . The additional structure on M is called a **Riemannian metric** and can be formalized, by the same process as for the tangent bundle itself, as a smooth section of a suitable vector bundle over M . A Riemannian manifold carries a natural Laplacian operator and other differential operators of interest that capture aspects of the geometry. One way of creating Riemannian manifolds is by embedding a smooth manifold of interest in a Riemannian manifold. For example one can embed any compact orientable 2-dimensional smooth manifold in \mathbb{R}^3 , and \mathbb{R}^3 carries a natural Riemannian metric. The inclusion of the manifold into \mathbb{R}^3 induces an inclusion of tangent spaces, and the Riemannian metric of \mathbb{R}^3 can be restricted to the manifold.

A fourth source is the field of several complex variables. The Cauchy–Riemann operator, consisting of $\frac{\partial}{\partial \bar{z}_j}$ in each complex variable z_j , makes sense on any open set, and the functions annihilated by it are the holomorphic functions. If a bounded open subset of \mathbb{C}^n has a smooth boundary, then the tangential component of the Cauchy–Riemann operator makes sense on smooth functions defined on the boundary. The significance of the tangential Cauchy–Riemann operator is that the functions annihilated by it are the ones that locally have extensions to holomorphic functions in a neighborhood of the boundary. The Lewy example,

mentioned in Section VII.2, ultimately comes from such a construction using the unit ball in \mathbb{C}^2 .

The subject being sufficiently rich with examples, let us establish the framework. Let M be an n -dimensional smooth manifold. It is customary to assume that M is separable. This condition is satisfied in all examples of interest, and in particular every compact manifold is separable. With the assumption of separability, we automatically obtain an **exhausting sequence** $\{K_j\}_{j=1}^\infty$ of compact sets such that $M = \bigcup_j K_j$ and $K_j \subseteq K_{j+1}^o$.

We have already introduced the associative algebras $C^\infty(M)$ and $C_{\text{com}}^\infty(M)$, and these spaces of functions need to be topologized. For $C^\infty(M)$, the topology is to be given by a countable separating family of seminorms, and convergence is to be uniform convergence of the function and all its derivatives on each compact subset of M . The exact family of seminorms will not matter, but we need to see that it is possible to specify one. Fix K_j . To each point p of K_j , associate a chart κ_p about p and associate also a compact neighborhood N_p of p lying within M_{κ_p} . For p in K_j , the interiors N_p^o of the N_p 's cover K_j , and we select a finite subcover $N_{p_1}^o, \dots, N_{p_r}^o$. Let $\kappa_{p_1}, \dots, \kappa_{p_r}$ be the corresponding charts. If φ is in $C^\infty(M)$, the seminorms of φ relating to K_j will be indexed by a multi-index α and an integer i with $1 \leq i \leq r$, the associated seminorm being $\sup_{x \in N_{p_i}} |D^\alpha(\varphi \circ \kappa_{p_i}^{-1})|$. When j is allowed to vary, the result is that $C^\infty(M)$ is a complete metric space with a metric given by countably many seminorms. If we construct seminorms by starting from a different exhausting sequence, then there is no difficulty in seeing that any seminorm in either construction is \leq a positive linear combination of seminorms from the other construction. Thus the identity mapping of $C^\infty(M)$ with the one metric to $C^\infty(M)$ with the other metric is uniformly continuous.

For $C_{\text{com}}^\infty(M)$, we use the inductive limit construction of Section IV.7 relative to the sequence of compact subsets K_j . That is, we let $C_{K_j}^\infty$ be the vector subspace of functions in $C_{\text{com}}^\infty(M)$ with support in K_j , we give $C_{K_j}^\infty$ the relative topology from $C^\infty(M)$, and then we form the inductive limit. Again the topology is independent of the exhausting sequence, and $C_{\text{com}}^\infty(M)$ is an LF space in the sense of Section IV.7.

The next step is to introduce distributions on manifolds, and there we encounter an unpleasant surprise. In Euclidean space the effect $\langle T, \varphi \rangle$ of a distribution on a function was supposed to generalize the effect $\langle f, \varphi \rangle = \int f \varphi dx$ of integration with a function f . The dx in the Euclidean case refers to Lebesgue measure. To get such an interpretation in the case of a manifold M , we have to use a measure on M , and there may be no canonical one. If we drop any insistence that distributions generalize integration with a function, then we encounter a different problem. The problem is that the three global notions — smooth function, distribution, and linear

functional on smooth functions — each have to satisfy certain transformation rules as we move from chart to chart, and these transformation rules are not compatible with having the space of distributions coincide with the space of linear functionals on smooth functions.

There are several ways of handling this problem, and we use one of them. What we shall do is fix a global but noncanonical notion of integration on M satisfying some smoothness properties. Thus we are constructing a positive linear functional λ on $C_{\text{com}}(M)$. We suppose given relative to each chart $\kappa = (x_1, \dots, x_n)$ a positive smooth function $g_\kappa(x)$ on \tilde{M}_κ such that $\lambda(\varphi) = \int_{\tilde{M}_\kappa} \varphi(\kappa^{-1}(x))g_\kappa(x) dx$ whenever φ is in $C_{\text{com}}(M_\kappa)$. Let $\kappa' = (y_1, \dots, y_n)$ be a second chart, and put $M_{\kappa, \kappa'} = M_\kappa \cap M_{\kappa'}$. If φ is in $C_{\text{com}}(M_{\kappa, \kappa'})$, then we require that

$$\int_{\kappa(M_{\kappa, \kappa'})} \varphi(\kappa^{-1}(x))g_\kappa(x) dx = \int_{\kappa'(M_{\kappa, \kappa'})} \varphi(\kappa'^{-1}(y))g_{\kappa'}(y) dy.$$

Substituting $y = \kappa'(\kappa^{-1}(x))$ on the right side, we can transform the right side into $\int_{\kappa(M_{\kappa, \kappa'})} \varphi(\kappa^{-1}(x))g_{\kappa'}(\kappa'(\kappa^{-1}(x))) \left| \det \left[\frac{\partial y_i}{\partial x_j} \right] \right| dx$ by the change-of-variables formula for multiple integrals. Thus the compatibility condition for the functions g_κ is that

$$g_\kappa(x) = g_{\kappa'}(y(x)) \left| \det \left[\frac{\partial y_i}{\partial x_j} \right] \right| \quad \text{for } x \in \kappa(M_{\kappa, \kappa'}), \quad y(x) = \kappa'(\kappa^{-1}(x)).$$

Conversely if this compatibility condition on the system of g_κ 's is satisfied, we can use a smooth partition of unity⁸ to define λ consistently and obtain a measure on M . This measure is a positive smooth function times Lebesgue measure in the image of any chart, and we refer to it as a **smooth measure** on M . We denote it by μ_g . The key formula for computing with it is

$$\int_M \varphi d\mu_g = \int_{\tilde{M}_\kappa} \varphi(\kappa^{-1}(x))g_\kappa(x) dx$$

for all Borel functions $\varphi \geq 0$ on M that equal 0 outside M_κ .

One can prove that a smooth measure always exists,⁹ and there are important cases in which a distinguished smooth measure exists. With Lie groups, for example, a left Haar measure is distinguished. With the quotient of a Lie group by a closed subgroup, Theorem 6.18 gives a necessary and sufficient condition for the existence of a nonzero left-invariant Borel measure, and that is distinguished. With a Riemannian manifold, there always exists a distinguished smooth measure that is definable directly in terms of the Riemannian metric.

⁸Smooth partitions of unity are discussed in Problem 5 at the end of the chapter.

⁹If every connected component of M is orientable, there is a positive smooth differential n -form, and it gives such a measure. All components are open; any nonorientable component has an orientable double cover with such a measure, and this can be pushed down to the given manifold.

The smooth measure is not unique, but any two smooth measures μ_g and μ_h are absolutely continuous with respect to each other. By the Radon–Nikodym Theorem we can therefore write $d\mu_g = F d\mu_h$ for a positive Borel function F ; the function F may be redefined on a set of measure 0 so as to be in $C^\infty(M)$, as we see by examining matters in local coordinates. Conversely if F is any everywhere-positive member of $C^\infty(M)$, then $F d\mu_g$ is another smooth measure.

If we fix a smooth measure μ_g , we can define spaces $L_{\text{com}}^1(M, \mu_g)$ and $L_{\text{loc}}^1(M, \mu_g)$ as follows: the first is the vector subspace of all members of $L^1(M, \mu_g)$ with compact support, and the second is the vector space of all functions, modulo null sets, whose restriction to each compact subset of M is in $L_{\text{com}}^1(M, \mu)$. It will not be necessary for us to introduce a topology on $L_{\text{com}}^1(M, \mu_g)$ or on $L_{\text{loc}}^1(M, \mu_g)$. If we replace μ_g by another smooth measure $d\mu_h = F d\mu_g$, then it is evident that $L_{\text{com}}^1(M, \mu_h) = L_{\text{com}}^1(M, \mu_g)$ and $L_{\text{loc}}^1(M, \mu_h) = L_{\text{loc}}^1(M, \mu_g)$.

We define $\mathcal{D}'(M)$ and $\mathcal{E}'(M)$ in the expected way: $\mathcal{D}'(M)$, which is the space of all **distributions** on M , is the vector space of all continuous linear functionals on $C_{\text{com}}^\infty(M)$, and $\mathcal{E}'(M)$ is the vector space of all continuous linear functionals on $C^\infty(M)$. The effect of a distribution T on a function φ continues to be denoted by $\langle T, \varphi \rangle$. The **support** of a distribution is the complement of the union of all open subsets U of M such that the distribution vanishes on $C_{\text{com}}^\infty(U)$. We omit the verification that $\mathcal{E}'(M)$ is exactly the subspace of members of $\mathcal{D}'(M)$ of compact support. It will not be necessary for us to introduce a topology on $\mathcal{D}'(M)$ or $\mathcal{E}'(M)$.

With the smooth measure μ_g fixed, we can introduce distributions T_f corresponding to certain functions f . If f is in $L_{\text{loc}}^1(M, \mu_g)$, we define T_f by

$$\langle T_f, \varphi \rangle = \int_M f \varphi d\mu_g \quad \text{for } \varphi \in C_{\text{com}}^\infty(M).$$

This is a member of $\mathcal{D}'(M)$. If f is in $L_{\text{com}}^1(M, \mu_g)$, we define T_f by

$$\langle T_f, \varphi \rangle = \int_M f \varphi d\mu_g \quad \text{for } \varphi \in C^\infty(M).$$

This is a member of $\mathcal{E}'(M)$.

As we did in the Euclidean case in Section V.2, we want to be able to pass from certain continuous linear operators L on smooth functions to linear operators on distributions. With μ_g replacing Lebesgue measure, the procedure is unchanged. We have a definition of L on functions, and we identify a continuous **transpose** operator L^{tr} on smooth functions satisfying the defining condition

$$\int_M L(f)\varphi d\mu_g = \int_M f L^{\text{tr}}(\varphi) d\mu_g.$$

Then we let

$$\langle L(T), \varphi \rangle = \langle T, L^{\text{tr}}(\varphi) \rangle.$$

For example, if L is the operator given as multiplication by the smooth function ψ , then $L^{\text{tr}} = L$ on smooth functions because we have $\int_M L(f)\varphi d\mu_g = \int_M (\psi f)(\varphi) d\mu_g = \int_M (f)(\psi\varphi) d\mu_g = \int_M fL(\varphi) d\mu_g$. Thus the definition is

$$\langle \psi T, \varphi \rangle = \langle T, \psi\varphi \rangle.$$

A **linear differential operator** L of order $\leq m$ on a manifold M is a continuous linear operator from $C^\infty(M)$ into itself with the property that for each point p in M , there is some compatible chart κ about p and there are functions a_α in $C^\infty(M_\kappa)$ such that the operator takes the form $Lf(q) = \sum_{|\alpha| \leq m} a_\alpha(q) D^\alpha f(q)$ for all f in $C^\infty(M_\kappa)$. Here if $\kappa = (x_1, \dots, x_n)$, then $D^\alpha f(q)$ is by definition the Euclidean expression $D^\alpha(f \circ \kappa^{-1})(x_1, \dots, x_n)$ evaluated at $\kappa(q)$.

If we have an expansion $Lf(q) = \sum_{|\alpha| \leq m} a_\alpha(q) D^\alpha f(q)$ in the chart κ about p and if κ' is another compatible chart about p , then a Euclidean change of variables shows that $Lf(q)$ is of the form $\sum_{|\beta| \leq m} d_\beta(q) D^\beta f(q)$ in the chart κ' for suitable smooth coefficient functions d_β .

The operator L carries the vector subspace $C_{\text{com}}^\infty(M)$ of $C^\infty(M)$ into itself and is continuous as a mapping of $C_{\text{com}}^\infty(M)$ into itself. One says that L has **order** m if in some compatible chart, some coefficient function a_α is not identically 0.

Let us compute how the transpose of a linear differential operator of order m acts on smooth functions. The claim is that this transpose is again a linear differential operator of order m . Since linear differential operators on open subsets of Euclidean space are mapped to other such operators by diffeomorphisms, it is enough to make a computation in a neighborhood of a point p within a compatible chart κ about p . Evidently the operation of taking the transpose is linear and reverses the order of operators, and we saw that multiplication by a smooth function is its own transpose. Thus it is enough to verify that the transpose of $\frac{\partial}{\partial x_j}$ is a linear differential operator.

To simplify the notation in the verification, let us abbreviate $\langle T_f, \varphi \rangle$ as $\langle f, \varphi \rangle$ when f and φ are smooth functions on M and at least one of them has compact support. That is, we set $\langle f, \varphi \rangle = \int_M f\varphi d\mu_g$. Let φ and ψ be in $C^\infty(M_\kappa)$, and assume that one of φ and ψ has compact support. With $\{g_\kappa\}$ as the system of functions defining the smooth measure μ_g , we have

$$\int_{\tilde{M}_\kappa} \frac{\partial}{\partial x_j} ((\psi \circ \kappa^{-1})(\varphi \circ \kappa^{-1})g_\kappa) dx = 0.$$

Expanding the derivative and setting $h_\kappa = g_\kappa \circ \kappa$ gives

$$\begin{aligned} \left(\left(\frac{\partial}{\partial x_j} \right)^{\text{tr}} \varphi, \psi \right) &= \left\langle \varphi, \frac{\partial \psi}{\partial x_j} \right\rangle \\ &= \int_{\tilde{M}_\kappa} \varphi(\kappa^{-1}(x)) \frac{\partial}{\partial x_j} (\psi \circ \kappa^{-1})(x) g_\kappa(x) dx \end{aligned}$$

$$\begin{aligned}
&= - \int_{\tilde{M}_\kappa} \psi(\kappa^{-1}(x)) \frac{\partial}{\partial x_j} ((\varphi \circ \kappa^{-1})g_\kappa)(x) dx \\
&= - \int_{\tilde{M}_\kappa} g_\kappa(x)^{-1} \psi(\kappa^{-1}(x)) \frac{\partial}{\partial x_j} ((\varphi \circ \kappa^{-1})g_\kappa)(x) g_\kappa(x) dx \\
&= - \int_{\tilde{M}_\kappa} (h_\kappa \circ \kappa^{-1})(x)^{-1} (\psi \circ \kappa^{-1})(x) \frac{\partial}{\partial x_j} ((\varphi \circ \kappa^{-1})(h_\kappa \circ \kappa^{-1}))(x) g_\kappa(x) dx.
\end{aligned}$$

Therefore $(\frac{\partial}{\partial x_j})^{\text{tr}} \varphi = (h_\kappa)^{-1} \psi \frac{\partial}{\partial x_j} (\varphi h_\kappa)$, and $(\frac{\partial}{\partial x_j})^{\text{tr}}$ is exhibited as a linear differential operator in local coordinates.

Certainly transpose does not increase the order of a linear differential operator. Applying transpose twice reproduces the original operator, and it follows that the transpose differential operator has the same order as the original.

If L is a linear differential operator acting on $C_{\text{com}}^\infty(M)$ or $C^\infty(M)$, we are now in a position to extend the definition of L to distributions. To do so, we form the linear differential operator L^{tr} such that $\langle L\varphi, \psi \rangle = \langle \varphi, L^{\text{tr}}\psi \rangle$ whenever φ and ψ are smooth on M and at least one of them has compact support. If T is in $\mathcal{D}'(M)$, we define $L(T)$ in $\mathcal{D}'(M)$ by $\langle L(T), \varphi \rangle = \langle T, L\varphi \rangle$ for φ in $C_{\text{com}}^\infty(M)$. If T is in $\mathcal{E}'(M)$, then we can allow φ to be $C^\infty(M)$, and the consequence is that $L(T)$ is in $\mathcal{E}'(M)$. Thus L carries $\mathcal{D}'(M)$ to itself and $\mathcal{E}'(M)$ to itself.

Recall from Section VII.6 that a linear differential operator $\sum_{|\alpha| \leq m} a_\alpha(x) D^\alpha$ of order m has, by definition, full symbol $\sum_{|\alpha| \leq m} a_\alpha(x) (2\pi i)^{|\alpha|} \xi^\alpha$ and principal symbol $\sum_{|\alpha|=m} a_\alpha(x) (2\pi i)^{|\alpha|} \xi^\alpha$, with the factors of $2\pi i$ reflecting the way that the Euclidean Fourier transform is defined in this book. When we try to extend this definition in a coordinate-free way to smooth manifolds M , we find no ready generalization of the full symbol, but we shall see that the principal symbol extends to be a certain kind of function on the cotangent bundle of M .

Let L be a linear differential operator on M of order m . Fix a point p in M , let $\kappa = (x_1, \dots, x_n)$ be a compatible chart about p , and let φ be in $C^\infty(M_\kappa)$. Suppose that D^α makes a contribution to L in this chart. For $t > 0$ and f in $C^\infty(M_\kappa)$, consider the expression

$$t^{-m} e^{-2\pi i t \varphi} D^\alpha (e^{2\pi i t \varphi} f) \quad \text{evaluated at } p.$$

We are interested in this expression in the limit $t \rightarrow \infty$. When $D^\alpha (e^{2\pi i t \varphi} f)$ is expanded by the Leibniz rule, each derivative that is applied to $e^{2\pi i t \varphi}$ yields a factor of t , and each derivative that is applied to f yields no such factor. Moreover, the exponentials cancel after the differentiations. The surviving dependence on t in each term is of the form t^{-r} , where $r \geq m - |\alpha|$. Thus our expression has limit 0 if $|\alpha| < m$. If $|\alpha| = m$, we get a nonzero contribution only when all the derivatives from the Leibniz rule are applied to f . Thus the limit of our expression with $|\alpha| = m$ is of the form $c D^\alpha f(p)$, where c is a constant depending on α and the germ of φ at p .

Meanwhile, our expression is unaffected by replacing φ by $\varphi - \varphi(p)$, and its dependence on φ is therefore as a member of \mathcal{C}_p^0 . A little checking shows that our expression is unchanged if a member of \mathcal{C}_p^1 is added to φ . Consequently our expression, for α fixed with $|\alpha| = m$, is a function on $\mathcal{C}_p^0/\mathcal{C}_p^1 = T_p^*(M)$.

Let us write a general member of $T_p^*(M)$ as (p, ξ) . We define the **principal symbol** of the linear differential operator L of order m to be the scalar-valued function $\sigma_L(p, \xi)$ on the real cotangent bundle $T^*(M, \mathbb{R})$ given by

$$\sigma_L(p, \xi)f(p) = \lim_{t \rightarrow \infty} t^{-m} e^{-2\pi i t \varphi(p)} L(e^{2\pi i t \varphi} f)(p),$$

where φ is chosen so that $d\varphi(p) = \xi$. Reviewing the construction above, we see that this definition is independent of f and of any choice of local coordinates.

We can compute the principal symbol explicitly if an expression for L is given in local coordinates. With our chart $\kappa = (x_1, \dots, x_n)$ as above, we know from Proposition 8.15 that the differentials $dx_1(p), \dots, dx_n(p)$ form a basis of $T_p^*(M)$. Let the expansion of the given cotangent vector ξ in this basis be $\xi = \sum_i \xi_i dx_i(p)$, and define $\varphi(x) = \sum_i \xi_i (x_i - x_i(p))$. This function has $d\varphi(p) = \xi$ by Proposition 8.15, and direct computation gives

$$\sigma_L(p, \xi) = \sum_{|\alpha|=m} a_\alpha(x) (2\pi i)^{|\alpha|} \xi^\alpha \quad \text{if } L = \sum_{|\alpha| \leq m} a_\alpha(x) D^\alpha.$$

In particular, $\sigma_L(p, \xi)$ is homogeneous of degree m in the ξ variable.¹⁰

6. More about Euclidean Pseudodifferential Operators

Before introducing pseudodifferential operators on an n -dimensional separable smooth manifold M , it is necessary to supplement the Euclidean theory as presented in Section VII.6. We need to understand the effect of transpose on a Euclidean pseudodifferential operator and also the effect of a diffeomorphism.

First let us consider transpose. If G is a pseudodifferential operator on $U \subseteq \mathbb{R}^n$, we know that

$$\langle G^{\text{tr}} \psi, \varphi \rangle = \langle \psi, G\varphi \rangle = \int_{\mathbb{R}^n} \int_U \int_U e^{2\pi i(x-y)\cdot\xi} g(x, \xi) \psi(x) \varphi(y) dy dx d\xi$$

for φ and ψ in $C_{\text{com}}^\infty(U)$. If we interchange x and y and replace ξ by $-\xi$, we obtain

$$\langle G^{\text{tr}} \psi, \varphi \rangle = \int_{\mathbb{R}^n} \int_U \int_U e^{2\pi i(x-y)\cdot\xi} g(y, -\xi) \psi(y) \varphi(x) dy dx d\xi.$$

¹⁰A function $\sigma(p, \xi)$ is **homogeneous of degree m** in the ξ variable if $\sigma(p, r\xi) = r^m \sigma(p, \xi)$ for all $r > 0$ and all $\xi \neq 0$.

The function that ought to play the role of the symbol of G^{tr} is $g(y, -\xi)$. It has a nontrivial y dependence, unlike what happens with pseudodifferential operators as defined in Section VII.6. Thus we cannot tell from this formula whether G^{tr} coincides with a pseudodifferential operator. Although it is possible to cope with this problem directly, a tidier approach is to enlarge the definition of pseudodifferential operator to allow dependence on y , as well as on x and ξ , in the function playing the role of the symbol. Then the transpose of one of the new operators will again be an operator of the same kind, and one can develop a theory for the enlarged class of operators.¹¹ Remarkably, as we shall see, the new class of operators turns out to be not so much larger than the original class.

Accordingly, let $S_{1,0,0}^m(U \times U)$ be the set of all functions g in $C^\infty(U \times U \times \mathbb{R}^n)$ such that for each compact set $K \subseteq U \times U$ and each triple of multi-indices (α, β, γ) , there exists a constant $C = C_{K,\alpha,\beta,\gamma}$ with

$$|D_\xi^\alpha D_x^\beta D_y^\gamma g(x, y, \xi)| \leq C(1 + |\xi|)^{m-|\alpha|} \quad \text{for } (x, y) \in K \text{ and } \xi \in \mathbb{R}^n.$$

Then $D_\xi^\alpha D_x^\beta D_y^\gamma g$ will be a symbol in the class $S_{1,0,0}^{m-|\alpha|}(U \times U)$. Let $S_{1,0,0}^{-\infty}(U \times U)$ be the intersection of all $S_{1,0,0}^{-n}(U \times U)$ for $n \geq 0$. A function $g(x, y, \xi)$ in $S_{1,0,0}^m(U \times U)$ is called an **amplitude**, and the **generalized pseudodifferential operator** that is associated to it is given by¹²

$$G\varphi(x) = \int_{\mathbb{R}^n} \int_U e^{2\pi i(x-y)\cdot\xi} g(x, y, \xi) \varphi(y) dy d\xi$$

for φ in $C_{\text{com}}^\infty(U)$. Such an operator is continuous from $C_{\text{com}}^\infty(U)$ into $C^\infty(U)$. The transposed operator G^{tr} such that $\langle G\varphi, \psi \rangle = \langle \varphi, G^{\text{tr}}\psi \rangle$ for φ and ψ in $C_{\text{com}}^\infty(U)$ is given by

$$G^{\text{tr}}\varphi(x) = \int_{\mathbb{R}^n} \int_U e^{2\pi i(y-x)\cdot\xi} g(y, x, \xi) \varphi(y) dy d\xi,$$

which becomes an operator of the same kind when we change ξ into $-\xi$. Because of the displayed formula for $G^{\text{tr}}\varphi(x)$, we are led to define

$$\langle Gf, \varphi \rangle = \left\langle f, \int_{\mathbb{R}^n} \int_U e^{2\pi i(y-(\cdot))\cdot\xi} g(y, \cdot, \xi) \varphi(y) dy d\xi \right\rangle$$

¹¹The theory for the new operators is the “tidier and faster” approach to Euclidean pseudodifferential operators that was mentioned just before the statement of Theorem 7.20.

¹²The use of the word “generalized” here is not standard terminology. It would be more standard to use some distinctive notation for the class of operators of this kind, but we have introduced no notation for it at all.

for $f \in \mathcal{E}'(U)$ and $\varphi \in C_{\text{com}}^\infty(U)$. Then Gf is in $\mathcal{D}'(U)$. In the special case that g is independent of its second variable, the above formula for $\langle Gf, \varphi \rangle$ reduces to the formula for $\langle Gf, \varphi \rangle$ in Section VII.6 as a consequence of Theorem 5.20 and an interchange of limits.¹³

If the amplitude of G is in $S_{1,0,0}^{-\infty}(U \times U)$, then the generalized pseudodifferential operator G carries $\mathcal{E}'(U)$ into $C^\infty(U)$, and it is consequently said to be a **smoothing operator**.

Following the pattern of the development in Section VII.6, we define a linear functional \mathcal{G} on $C_{\text{com}}^\infty(U \times U)$ by the formula

$$\langle \mathcal{G}, w \rangle = \int_{\mathbb{R}^n} \left[\int_{U \times U} e^{2\pi i(x-y)\cdot\xi} g(x, y, \xi) w(x, y) dx dy \right] d\xi.$$

Then \mathcal{G} is continuous and hence is a member of $\mathcal{D}'(U \times U)$. The formal expression

$$\mathcal{G}(x, y) = \int_{\mathbb{R}^n} e^{2\pi i(x-y)\cdot\xi} g(x, y, \xi) d\xi$$

is called the **distribution kernel** of G ; again it is not to be regarded as a function but as an expression that defines a distribution.

With the insertion of the word “generalized” in front of “pseudodifferential operator,” Theorem 7.19 remains true word for word; the distribution kernel is a smooth function off the diagonal in $U \times U$, and the operator is **pseudolocal**.

We extend the definition of **properly supported** from pseudodifferential operators to the generalized operators. Examining the extended definition along with the formula for the distribution kernel, we see that G is properly supported if and only if G^t is properly supported. The main theorem concerning generalized pseudodifferential operators is as follows.

Theorem 8.17. For U open in \mathbb{R}^n , let G be the generalized pseudodifferential operator corresponding to an amplitude $g(x, y, \xi)$ in $S_{1,0,0}^m(U \times U)$, and suppose that G is properly supported. Then

- (a) G is the pseudodifferential operator with symbol

$$g(x, \xi) = e^{-2\pi i x \cdot \xi} G(e^{2\pi i(\cdot)\cdot\xi}) \quad \text{in } S_{1,0}^m(U),$$

- (b) the symbol $g(x, \xi)$ has asymptotic series

$$g(x, \xi) \sim \sum_{\alpha} \frac{(2\pi i)^{-|\alpha|}}{\alpha!} D_{\xi}^{\alpha} D_y^{\alpha} g(x, y, \xi) \Big|_{y=x}.$$

¹³This discussion therefore completes the justification of the definition of $\langle Gf, \varphi \rangle$ in Section VII.6.

In (a) of Theorem 8.17, the fact that G is properly supported implies that G extends to be defined on $C^\infty(U)$, and $e^{2\pi i(\cdot)\cdot\xi}$ is a member of this space. The operator \tilde{G} with symbol $g(x, \xi)$ as in (a) is given by

$$\tilde{G}\varphi(x) = \int_{\mathbb{R}^n} e^{2\pi i x \cdot \xi} g(x, \xi) \widehat{\varphi}(\xi) d\xi = \int_{\mathbb{R}^n} G(e^{2\pi i(\cdot)\cdot\xi}) \widehat{\varphi}(\xi) d\xi,$$

and the assertion in (a) is that this equals $G\varphi(x)$. Consequently the assertion is that if G is applied to the formula $\varphi(x) = \int_{\mathbb{R}^n} e^{2\pi i x \cdot \xi} \widehat{\varphi}(\xi) d\xi$, then G may be moved under the integral sign. This interchange of limits is almost handled pointwise for each x by Problem 5 in Chapter V, but we cannot take the compact metric space K in that problem to be all of \mathbb{R}^n . Instead, we take K to be a large ball in \mathbb{R}^n , apply the result of Problem 5, and do a passage to the limit.

The proof of (b) is long but reuses some of the omitted proof of Theorem 7.20. In the course of the argument, one obtains as a byproduct a conclusion that does not make use of the hypothesis “properly supported.” Theorem 8.18 may be regarded as an extension of Theorem 7.22a to the present setting.

Theorem 8.18. For U open in \mathbb{R}^n , let G be the generalized pseudodifferential operator corresponding to an amplitude in $S_{1,0,0}^m(U \times U)$. Then there exist a pseudodifferential operator G_1 with symbol in $S_{1,0}^m(U)$ and a generalized pseudodifferential operator G_2 corresponding to an amplitude in $S_{1,0,0}^{-\infty}(U \times U)$ such that $G = G_1 + G_2$.

In any event, Theorem 8.17 is the heart of the theory of generalized pseudodifferential operators in Euclidean space, and most other results are derived from it. It is immediate from Theorem 8.17 that if G is a properly supported pseudodifferential operator as in Chapter VII with symbol $g(x, \xi)$ in $S_{1,0}^m(U)$, then so is G^{tr} , and furthermore the symbol $g^{\text{tr}}(x, \xi)$ has asymptotic series

$$g^{\text{tr}}(x, \xi) \sim \sum_{\alpha} \frac{(2\pi i)^{-|\alpha|}}{\alpha!} D_{\xi}^{\alpha} D_x^{\alpha} g(x, -\xi).$$

In the treatment of composition, the result is unchanged from Theorem 7.22b, but the use of amplitudes greatly simplifies the proof. In fact, let G and H be two properly supported pseudodifferential operators with respective symbols g and h , and let h^{tr} be the symbol of H^{tr} . Since $H = (H^{\text{tr}})^{\text{tr}}$, we have

$$H\varphi(x) = \int_{\mathbb{R}^n} \int_U e^{2\pi i(x-y)\cdot\xi} h^{\text{tr}}(y, -\xi) \varphi(y) dy d\xi \quad \text{for } \varphi \in C_{\text{com}}^{\infty}(U).$$

Using Fourier inversion, we recognize this formula as saying that $\widehat{H\varphi}(\xi) = \int_U e^{-2\pi i y \cdot \xi} h^{\text{tr}}(y, -\xi) \varphi(y) dy$. Substituting $\psi = H\varphi$ in the formula $G\psi(x) = \int_{\mathbb{R}^n} e^{2\pi i x \cdot \xi} g(x, \xi) \widehat{\psi}(\xi) d\xi$ therefore gives

$$GH\varphi(x) = \int_{\mathbb{R}^n} \int_U e^{2\pi i(x-y)\cdot\xi} g(x, \xi) h^{\text{tr}}(y, -\xi) \varphi(y) dy d\xi.$$

We conclude that GH is the generalized pseudodifferential operator with amplitude $g(x, \xi)h^{\text{tr}}(y, -\xi)$. Applying Theorem 8.17b and sorting out the asymptotic series that the theorem gives, we obtain a quick proof of Theorem 7.22b.

We turn to the effect of diffeomorphisms on Euclidean pseudodifferential operators. Let $\Phi : U \rightarrow U^\#$ be a diffeomorphism between open subsets of \mathbb{R}^n , and suppose that a generalized pseudodifferential operator $G : C_{\text{com}}^\infty(U) \rightarrow C^\infty(U)$ is given by

$$G\varphi(x) = \int_{\mathbb{R}^n} \int_U e^{2\pi i(x-y)\cdot\xi} g(x, y, \xi) \varphi(y) dy d\xi$$

for φ in $C_{\text{com}}^\infty(U)$. We define $G^\#$ to be the operator carrying $C_{\text{com}}^\infty(U^\#)$ to $C^\infty(U^\#)$ and given by

$$G^\#\psi = (G(\psi \circ \Phi)) \circ \Phi^{-1} \quad \text{for } \psi \in C_{\text{com}}^\infty(U^\#).$$

Our objectives are to see that $G^\#$ is a generalized pseudodifferential operator, to obtain a formula for an amplitude of it, and to examine the effect on symbols.

Let us put $x^\# = \Phi(x)$ and $y^\# = \Phi(y)$. Put $\Phi_1 = \Phi^{-1}$. Direct use of the change-of-variables formula for multiple integrals gives

$$\begin{aligned} G^\#\psi(x^\#) &= G(\psi \circ \Phi)(x) = \int_{\mathbb{R}^n} \int_U e^{2\pi i(x-y)\cdot\xi} g(x, y, \xi) \psi(\Phi(y)) dy d\xi \\ &= \int_{\mathbb{R}^n} \int_{U^\#} e^{2\pi i(\Phi_1(x^\#) - \Phi_1(y^\#))\cdot\xi} g(\Phi_1(x^\#), \Phi_1(y^\#), \xi) \psi(y^\#) |\det((\Phi_1)'(y^\#))| dy^\# d\xi. \end{aligned}$$

The hard part in showing that the expression on the right side is a generalized pseudodifferential operator is to handle the exponential factor. The starting point is the formula

$$\Phi_1(x^\#) - \Phi_1(y^\#) = \int_0^1 (\Phi_1)'(tx^\# + (1-t)y^\#)(x^\# - y^\#) dt,$$

which is valid if the line segment from $x^\#$ to $y^\#$ lies in $U^\#$ and which follows from the directional derivative formula and the Fundamental Theorem of Calculus. From that, one derives the following lemma.

Lemma 8.19. About each point $X = (p^\#, q^\#)$ of $U^\# \times U^\#$, there exist an open neighborhood N_X and a smooth function $J_X : N_X \rightarrow GL(n, \mathbb{F})$ such that

$$\Phi_1(x^\#) - \Phi_1(y^\#) = J_X(x^\#, y^\#)(x^\# - y^\#)$$

for every $(x^\#, y^\#)$ in N_X .

The lemma allows us to write $e^{2\pi i(\Phi_1(x^\#) - \Phi_1(y^\#)) \cdot \xi} = e^{2\pi i(x^\# - y^\#) \cdot J_X(x^\#, y^\#)^{\text{tr}}(\xi)}$ for $(x^\#, y^\#)$ in N_X . Thus locally we can convert the integrand for $G^\# \psi(x^\#)$ into the integrand of a generalized pseudodifferential operator. It is just a question of fitting the pieces together. Using an exhausting sequence for $U^\#$ and a smooth partition of unity,¹⁴ one can find a sequence of points X_j and smooth functions h_j with values in $[0, 1]$ such that h_j has compact support in N_{X_j} , such that each point of $U^\# \times U^\#$ has a neighborhood in which only finitely many h_j are nonzero, and such that $\sum_j h_j$ is identically 1. Let J_j be the function J_{X_j} of the lemma. Sorting out the details leads to the following result.

Theorem 8.20. If $\Phi : U \rightarrow U^\#$ is a diffeomorphism between open sets in \mathbb{R}^n , if $G : C_{\text{com}}^\infty(U) \rightarrow C^\infty(U)$ is the generalized pseudodifferential operator with amplitude $g(x, y, \xi)$ in $S_{1,0,0}^m(U \times U)$, and if $G^\#$ is defined by $G^\# \psi = (G(\psi \circ \Phi)) \circ \Phi^{-1}$, then $G^\#$ is the generalized pseudodifferential operator on $U^\#$ with amplitude

$$g^\#(x^\#, y^\#, \eta) = |\det(\Phi^{-1})'(x^\#)| \\ \times \left(\sum_j h_j(x^\#, y^\#) |\det J_j(x^\#, y^\#)|^{-1} g(x, y, (J_j(x^\#, y^\#)^{-1})^{\text{tr}}(\eta)) \right)$$

in $S_{1,0,0}^m(U^\# \times U^\#)$, where $x = \Phi^{-1}(x^\#)$ and $y = \Phi^{-1}(y^\#)$. If G is properly supported, then so is $G^\#$.

Under the assumption that G and $G^\#$ are properly supported and G has symbol $g(x, \xi)$, let us use Theorem 8.17 to compute the symbol of $G^\#$, starting from the formula in Theorem 8.20. For that computation all that is needed is the values of $g^\#(x^\#, y^\#, \eta)$ for $(x^\#, y^\#)$ in any single neighborhood of the diagonal, however small the neighborhood.

In Lemma 8.19, one can arrange for a single N_X , say the one for $X = X_1$, to contain the entire diagonal of $U^\# \times U^\#$. The point X_1 can be one of the points used in forming the partition of unity, and the corresponding function h_1 can be arranged to be identically 1 in a neighborhood of the diagonal. Thus for purposes of computing the symbol, we may drop all the terms for $j \neq 1$ and write the formula of Theorem 8.20 as

$$g^\#(x^\#, y^\#, \eta) \approx |\det(\Phi^{-1})'(x^\#)| |\det J_1(x^\#, y^\#)|^{-1} g(x, (J_1(x^\#, y^\#)^{-1})^{\text{tr}}(\eta)).$$

Theorem 8.17b says that $g^\#(x, \eta) \sim \sum_\alpha \frac{(2\pi i)^{-|\alpha|}}{\alpha!} D_\eta^\alpha D_{y^\#}^\alpha g^\#(x^\#, y^\#, \eta)|_{y^\#=x^\#}$. The term for $\alpha = 0$ in Theorem 8.17 comes from taking $y^\# = x^\#$ in $g^\#(x^\#, y^\#, \eta)$. The function J_1 simplifies for this calculation and gives $J_1(x^\#, x^\#) = (\Phi^{-1})'(x^\#)$. Let us summarize.

¹⁴Smooth partitions of unity are discussed in Problem 5 at the end of the chapter.

Corollary 8.21. If $\Phi : U \rightarrow U^\#$ is a diffeomorphism between open sets in \mathbb{R}^n , if $G : C_{\text{com}}^\infty(U) \rightarrow C^\infty(U)$ is a properly supported pseudodifferential operator with symbol $g(x, \xi)$ in $S_{1,0}^m(U)$, and if $G^\#$ is defined by $G^\# \psi = (G(\psi \circ \Phi)) \circ \Phi^{-1}$, then $G^\#$ is a properly supported pseudodifferential operator on $U^\#$, and its symbol $g^\#(x^\#, \eta)$ has the property that

$$g^\#(x^\#, \eta) = g(\Phi^{-1}(x^\#), (((\Phi^{-1})'(x^\#))^{-1})^{\text{tr}}(\eta))$$

is in $S_{1,0}^{m-1}(U^\#)$.

7. Pseudodifferential Operators on Manifolds

With the Euclidean theory and the necessary tools of manifold theory in place, we can now introduce pseudodifferential operators on manifolds. Let M be an n -dimensional separable smooth manifold. A typical compatible chart will be denoted by $\kappa : M_\kappa \rightarrow \tilde{M}_\kappa$, where M_κ is open in M and \tilde{M}_κ is open in \mathbb{R}^n . Fix a smooth measure μ_g on M as in Section 5, and let $\langle \varphi_1, \varphi_2 \rangle = \int_M \varphi_1 \varphi_2 d\mu_g$ whenever φ_1 and φ_2 are in $C^\infty(M)$ and at least one of them has compact support.

A pseudodifferential operator on M is going to be a certain kind of continuous linear operator G from $C_{\text{com}}^\infty(M)$ into $C^\infty(M)$. The operator $G^{\text{tr}} : C_{\text{com}}^\infty(M) \rightarrow C^\infty(M)$ such that $\langle G\varphi_1, \varphi_2 \rangle = \langle \varphi_1, G^{\text{tr}}\varphi_2 \rangle$ for φ_1 and φ_2 in $C_{\text{com}}^\infty(M)$ will be another continuous linear operator of the same kind, and therefore the definition

$$\langle G(T), \varphi \rangle = \langle T, G^{\text{tr}}(\varphi) \rangle \quad \text{for } \varphi \in C_{\text{com}}^\infty(M) \text{ and } T \in \mathcal{E}'(M)$$

extends our G to a linear function $G : \mathcal{E}'(M) \rightarrow \mathcal{D}'(M)$ in a natural way.

For any continuous linear operator $G : C_{\text{com}}^\infty(M) \rightarrow C^\infty(M)$, the scalar-valued function $\langle G\varphi_1, \varphi_2 \rangle$ on $C_{\text{com}}^\infty(M) \times C_{\text{com}}^\infty(M)$ is continuous and linear in each variable when the other variable is held fixed, and it follows from a result known as the Schwartz Kernel Theorem¹⁵ that there exists a unique distribution \mathcal{G} in $\mathcal{D}'(M \times M)$ such that

$$\langle G\varphi_1, \varphi_2 \rangle = \langle \mathcal{G}, \varphi_1 \otimes \varphi_2 \rangle \quad \text{for } \varphi_1 \in C_{\text{com}}^\infty(M) \text{ and } \varphi_2 \in C_{\text{com}}^\infty(M),$$

where $\varphi_1 \otimes \varphi_2$ is the function on $M \times M$ with $(\varphi_1 \otimes \varphi_2)(x, y) = \varphi_1(x)\varphi_2(y)$. We call \mathcal{G} the **distribution kernel** of G . The distribution kernel \mathcal{G}^{tr} of G^{tr} is obtained from the distribution kernel \mathcal{G} by interchanging x and y .

In analogy with the Euclidean situation, we say that G is **properly supported** if the subset $\text{support}(\mathcal{G})$ of $M \times M$ has compact intersection with $K \times M$ and with

¹⁵A special case of the Schwartz Kernel Theorem is proved in Problems 14–19 at the end of Chapter V. This special case is at the heart of the matter in the general case.

$M \times K$ for every compact subset K of M . In this case it follows for each compact subset K of M that there exists a compact subset L of M such that $G(C_K^\infty) \subseteq C_L^\infty$. Concretely the set L is $p_1((M \times K) \cap \text{support}(\mathcal{G}))$, where $p_1(x, y) = x$. Then it is immediate that G carries $C_{\text{com}}^\infty(M)$ into $C_{\text{com}}^\infty(M)$ and is continuous as such a map. The same thing is true of G^{tr} since the definition of proper support is symmetric in x and y , and therefore the definition

$$\langle G(T), \varphi \rangle = \langle T, G^{\text{tr}}(\varphi) \rangle \quad \text{for } \varphi \in C_{\text{com}}^\infty(M) \text{ and } T \in \mathcal{D}'(M)$$

extends the properly supported G to a linear function $G : \mathcal{D}'(M) \rightarrow \mathcal{D}'(M)$ in a natural way.

A **pseudodifferential operator** of order $\leq m$ on M is a continuous linear operator $G : C_{\text{com}}^\infty(M) \rightarrow C^\infty(M)$ with the property, for every compatible chart κ , that the operator $G_\kappa : C_{\text{com}}^\infty(\tilde{M}_\kappa) \rightarrow C^\infty(\tilde{M}_\kappa)$ given by

$$G_\kappa(\psi) = G(\psi \circ \kappa)|_{M_\kappa} \circ \kappa^{-1} \quad \text{for } \psi \in C_{\text{com}}^\infty(\tilde{M}_\kappa)$$

is a generalized pseudodifferential operator on \tilde{M}_κ defined by an amplitude in $S_{1,0,0}^m(\tilde{M}_\kappa \times \tilde{M}_\kappa)$. Theorem 8.20 shows that this condition about all compatible charts is satisfied if it holds for all charts in an atlas.

For such an operator the distribution kernel is automatically a smooth function away from the diagonal of $M \times M$, as a consequence of the same fact about Euclidean pseudodifferential operators. One has only to realize that if two distinct points of M are given, then one can find compatible charts about the points whose domains are disjoint and whose images are disjoint; then the union of the charts is a compatible chart, and the fact about Euclidean operators can be applied.

For a distribution on a smooth manifold, it makes sense to speak of the **singular support** as the union of all open sets on which the distribution is a smooth function, and the above fact about the distribution kernel implies that any pseudodifferential operator G on M is **pseudolocal** in the sense that the singular support of $G(T)$ is contained in the singular support of T for every T in $\mathcal{E}'(M)$.

The composition of two properly supported pseudodifferential operators on M is certainly defined as a continuous linear operator from $C_{\text{com}}^\infty(M)$ into itself, but a little care is needed in checking that the composition, when referred to a compatible chart κ , is a generalized pseudodifferential operator on \tilde{M}_κ . The reason is that when G is properly supported on M , it does not follow that the restriction of G to M_κ , i.e., to $C_{\text{com}}^\infty(M_\kappa)$, is properly supported, not even if M is an open subset of \mathbb{R}^n . To handle this problem, we start from this observation: if G is any pseudodifferential operator on M , if V is open in M , and if ψ_1 and ψ_2 are in $C_{\text{com}}^\infty(V)$, then the operator defined for φ in $C_{\text{com}}^\infty(V)$ by $\varphi \mapsto \psi_1 G(\psi_2 \varphi)$ is a properly supported pseudodifferential operator on V ; in fact, the distribution kernel of this operator is supported in the compact subset $\text{support}(\psi_2) \times \text{support}(\psi_1)$ of $V \times V$.

This observation, the device used above for showing that distribution kernels are smooth off the diagonal, and an argument with a partition of unity yield a proof of the following lemma.

Lemma 8.22. If L is a properly supported pseudodifferential operator on M of order $\leq m$ and K is a compact subset of M_κ for some compatible chart κ of M , then there exist compatible charts $\kappa_0, \kappa_1, \dots, \kappa_r$ with $\kappa_0 = \kappa$, with each M_{κ_i} containing K and, for each $i \geq 0$, with a properly supported pseudodifferential operator L_i on M_{κ_i} such that $L(\varphi) = \sum_{i=0}^r L_i(\varphi)$ for every φ in C_K^∞ .

PROOF. Choose K' compact such that $\varphi \in C_K^\infty$ implies $L(\varphi) \in C_{K'}^\infty$, and let $\psi \geq 0$ be a member of $C_{\text{com}}^\infty(M)$ that is 1 in a neighborhood of K' . Next choose open neighborhoods N, N', N'' of K such that $N'' \subseteq N''^{\text{cl}} \subseteq N' \subseteq N'^{\text{cl}} \subseteq N \subseteq N^{\text{cl}} \subseteq M_\kappa$ with N^{cl} compact. Finally choose $\psi_1 \in C_{\text{com}}^\infty(M)$ with values in $[0, 1]$ that is 1 on N' and is 0 on N^c . Then $1 - \psi_1$ is 0 on N' and hence has support disjoint from K . Define $\psi_2 = (1 - \psi_1)\psi$.

For each x in the compact support of ψ_2 , find a compatible chart containing x with domain V_x contained in N''^c . The sets V_x cover $\text{support}(\psi_2)$, and there is a finite subcover V_1, \dots, V_r . Since each V_i with $i \geq 1$ is the domain of a compatible chart and since $V_i \cap N'' = \emptyset$, there exists a compatible chart κ_i with domain $V_i \cup N''$. Within the sets V_i , we can find open subsets W_i with W_i^{cl} compact in V_i such that the W_i cover $\text{support}(\psi_2)$. Repeating this process, we can find open subsets X_i with X_i^{cl} compact in W_i such that the X_i cover $\text{support}(\psi_2)$. By choosing, for each i , a smooth function on $\cup V_i$ with values in $[0, 1]$ that is 1 on X_i and is 0 off W_i^{cl} and by then dividing by the sum of these and a smooth function that is positive on $\cup V_i - \cup W_i$ and is 0 in a neighborhood of $\text{support}(\psi_2)$, we can produce smooth functions η_1, \dots, η_r on $\cup V_i$, all ≥ 0 , with sum identically 1 in a neighborhood of $\text{support}(\psi_2)$ such that η_i has compact support in V_i . Then the operators $L_0(\varphi) = \psi_1 L(\psi_1 \varphi)$ and, for $i \geq 1$, $L_i(\varphi) = \eta_i \psi_2 L(\psi_1 \varphi)$ have the required properties. \square

If we have a composition $J = GH$ of properly supported pseudodifferential operators, we apply the lemma to H to write $GH(\varphi) = \sum_i G(H_i(\varphi))$. For each i , all members of $H_i(C_K^\infty)$ have support in some compact subset L_i of M_{κ_i} . Thus we can apply the lemma again to G and the set L_i to write G as a certain sum in a fashion depending on i . The result is that GH is exhibited on C_K^∞ as a sum of terms, each of which is the composition of properly supported operators within a compatible chart. Since compositions of properly supported generalized pseudodifferential operators in Euclidean space are again properly supported generalized pseudodifferential operators, each term of the sum is a pseudodifferential operator on M . Thus $J = GH$ is a pseudodifferential operator on M .

We turn to the question of symbols. As with linear differential operators, which were discussed in Section 5, we cannot expect a coordinate-free meaning for the symbol of a pseudodifferential operator on the smooth manifold M , even if the operator is properly supported. But we can associate a “principal symbol” to such an operator in many cases, generalizing the result for differential operators in Section 5. For a linear differential operator of order m , we saw that the principal symbol is a smooth function on the cotangent bundle $T^*(M, \mathbb{R})$ that is homogeneous of degree m in each fiber. For a pseudodifferential operator whose order is not a nonnegative integer, the homogeneity may disrupt the smoothness at the origin of each fiber, and we thus have to allow for a singularity. Accordingly, let $T^*(M, \mathbb{R})^\times$ denote the cotangent bundle with the zero section removed, i.e., the closed subset consisting of the 0 element of each fiber is to be removed. The **principal symbol** of order m for a properly supported pseudodifferential operator G of order $\leq m$ on M will turn out to be, in cases where it is defined, a smooth function on $T^*(M, \mathbb{R})^\times$ that is homogeneous of degree m in each fiber.

Let G be a pseudodifferential operator of order $\leq m$ on M , and let κ be a compatible chart. Let $G_\kappa(\psi) = G(\psi \circ \kappa)|_{M_\kappa} \circ \kappa^{-1}$ be the corresponding generalized pseudodifferential operator on \tilde{M}_κ , and let $g_\kappa(x, y, \xi)$ be an amplitude for it, so that $g_\kappa(x, y, \xi)$ is in $S_{1,0,0}^m(\tilde{M}_\kappa \times \tilde{M}_\kappa)$. Suppose that $\sigma_\kappa(x, \xi)$ is a smooth function on $\tilde{M}_\kappa \times (\mathbb{R}^n - \{0\})$ that is homogeneous of degree m in the ξ variable for each fixed x in \tilde{M}_κ . The function $\sigma_\kappa(x, \xi)$ is not necessarily in $S_{1,0}^m(\tilde{M}_\kappa)$ because of the potential singularity at $\xi = 0$, but the function $\tau(\ell_x(\xi))\sigma_\kappa(x, \xi)$ is in $S_{1,0}^m(\tilde{M}_\kappa)$ if τ is a smooth scalar-valued function on \mathbb{R}^n that is 0 in a neighborhood of 0 and is 1 for $|\xi|$ sufficiently large and if $x \mapsto \ell_x$ is a smooth function from \tilde{M}_κ into $GL(n, \mathbb{F})$. Moreover, for any two choices of τ and ℓ_x of this kind, the difference of the two symbols $\tau(\ell_x(\xi))\sigma_\kappa(x, \xi)$ is the symbol of a smoothing operator. Fix such a τ and ℓ_x . We say that G_κ has **principal symbol** $\sigma_\kappa(x, \xi)$ if there is some $\varepsilon > 0$ such that $g_\kappa(x, y, \xi) - \tau(\ell_x(\xi))\sigma_\kappa(x, \xi)$ is in $S_{1,0,0}^{m-\varepsilon}(\tilde{M}_\kappa \times \tilde{M}_\kappa)$. This condition is independent of τ and ℓ_x . We say that the given pseudodifferential operator G of order $\leq m$ **has a principal symbol**, namely the family $\{\sigma_\kappa(x, \xi)\}$ as κ varies, if this condition is satisfied for every κ and if ε can be taken to be independent of κ .

In this case we shall show that $\{\sigma_\kappa(x, \xi)\}$ is the system of local expressions for a scalar-valued function on the part of the cotangent bundle of M where $\xi \neq 0$, the dependence in the cotangent space being homogeneous of degree m at each point of M ; consequently one refers also to this function on $T^*(M, \mathbb{R})^\times$ as the **principal symbol**. There is no assertion that a principal symbol exists, but it will be unique when it exists.¹⁶ Moreover, this definition agrees with the definition

¹⁶Some authors define the principal symbol more broadly—the local expression being the coset of amplitudes for G modulo amplitudes in $S_{1,0,0}^{m-\varepsilon}(\tilde{M}_\kappa \times \tilde{M}_\kappa)$. This alternative definition, however,

in Section 5 in the case of a linear differential operator on M . To see that the functions $\sigma_\kappa(x, \xi)$ correspond to a single function on $T^*(M, \mathbb{R})^\times$, suppose that κ and κ' are compatible charts whose domains overlap. Let $\kappa = (x_1, \dots, x_n)$ and $\kappa' = (y_1, \dots, y_n)$. We write $y = y(x)$ for the function $\kappa' \circ \kappa^{-1}$ and $x = x(y)$ for the inverse function $\kappa \circ \kappa'^{-1}$. Theorem 8.18 shows that there is no loss of generality in assuming that the local expressions for G in the charts κ and κ' have symbols in $S_{1,0}^m(\tilde{M}_\kappa)$ and $S_{1,0}^m(\tilde{M}_{\kappa'})$. Let these be $g_\kappa(x, \xi)$ and $g_{\kappa'}(y, \eta)$. Corollary 8.21 shows that

$$g_{\kappa'}(y, \eta) - g_\kappa(x(y), \left(\left[\frac{\partial x_i(y)}{\partial y_j}\right]^{-1}\right)^{\text{tr}}(\eta))$$

is in $S_{1,0}^{m-1}(\kappa'(M_\kappa \cap M_{\kappa'}))$. Our construction shows that

$$g_{\kappa'}(y, \eta) - \tau_1(\eta)\sigma_{\kappa'}(y, \eta)$$

and

$$g_\kappa(x(y), \left(\left[\frac{\partial x_i(y)}{\partial y_j}\right]^{-1}\right)^{\text{tr}}(\eta)) - \tau_2\left(\left[\frac{\partial x_i(y)}{\partial y_j}\right]^{-1}\right)^{\text{tr}}(\eta)\sigma_\kappa(x(y), \left(\left[\frac{\partial x_i(y)}{\partial y_j}\right]^{-1}\right)^{\text{tr}}(\eta))$$

are in $S_{1,0}^{m-\varepsilon}(\kappa'(M_\kappa \cap M_{\kappa'}))$. Therefore

$$\tau_2\left(\left[\frac{\partial x_i(y)}{\partial y_j}\right]^{-1}\right)^{\text{tr}}(\eta)\sigma_\kappa(x(y), \left(\left[\frac{\partial x_i(y)}{\partial y_j}\right]^{-1}\right)^{\text{tr}}(\eta)) - \tau_1(\eta)\sigma_{\kappa'}(y, \eta)$$

is in $S_{1,0}^{m-\varepsilon'}(\kappa'(M_\kappa \cap M_{\kappa'}))$ for $\varepsilon' = \min(1, \varepsilon)$. For y fixed and $|\eta|$ sufficiently large, each term in this expression has the property that its value at $r\eta$ is r^m times its value at η if $r \geq 1$. Then the same thing is true of the difference. Since the condition of being in $S_{1,0}^{m-\varepsilon'}(\kappa'(M_\kappa \cap M_{\kappa'}))$ says that the absolute value of the difference at $r\eta$ has to be $\leq r^{m-\varepsilon'}$ times the absolute value of the difference at η , the difference has to be 0 for η sufficiently large. Therefore

$$\sigma_\kappa(x(y), \left(\left[\frac{\partial x_i(y)}{\partial y_j}\right]^{-1}\right)^{\text{tr}}(\eta)) = \sigma_{\kappa'}(y, \eta)$$

for y in $\kappa'(M_\kappa \cap M_{\kappa'})$. According to a computation with $T^*(M)$ in Section 4, the family $\{\sigma_\kappa(x, \xi)\}$ satisfies the correct compatibility condition to be regarded as a scalar-valued function on $T^*(M, \mathbb{R})^\times$. In short, we can treat the principal symbol as a scalar-valued function on the cotangent bundle minus the zero section.

does not reduce to the definition made in Section 5 for linear differential operators, and it seems wise in the present circumstances to avoid it.

The pseudodifferential operator G on M is said to be **elliptic** of order m if its principal symbol is nowhere 0 on $T^*(M, \mathbb{R})^\times$. It is a simple matter to check that ellipticity in this sense is equivalent to the condition that all the local expressions for the operator differ by smoothing operators¹⁷ from operators that are elliptic of order m in the sense of Chapter VII.

Theorem 7.24 extends from Euclidean space to separable smooth manifolds: any properly supported elliptic operator G has a two-sided parametrix, i.e., a properly supported pseudodifferential operator H having $GH = 1 + \text{smoothing}$ and $HG = 1 + \text{smoothing}$. The proof consists of using Theorem 7.24 for each member of an atlas and patching the results together by a smooth partition of unity. A certain amount of work is necessary to arrange that the local operators are properly supported. We omit the details.

As usual, the existence of the left parametrix implies a regularity result—that the singular support of Gf equals the singular support of f if f is in $\mathcal{E}'(M)$.

8. Further Developments

Having arrived at a point in studying pseudodifferential operators on manifolds comparable with where the discussion stopped for the Euclidean case, let us briefly mention some further aspects of the theory that have a bearing on parts of mathematics outside real analysis.

1. Quantitative estimates. Much of the discussion thus far has concerned the effect of pseudodifferential operators on spaces of smooth functions of compact support, and rather little has concerned distributions. Useful investigations of what happens to distributions under such operators require further tools that distinguish some distributions from others. A fundamental such tool is the continuous family of Sobolev spaces denoted by H^s , or more specifically by $H_{\text{com}}^s(M)$ or $H_{\text{loc}}^s(M)$, with s being an arbitrary real number.

The starting point is the family of Hilbert spaces $H^s(\mathbb{R}^n)$ that were introduced in Problems 8–12 at the end of Chapter III. The space $H^s(\mathbb{R}^n)$ consists of all tempered distributions $T \in \mathcal{S}'(\mathbb{R}^n)$ whose Fourier transforms $\mathcal{F}(T)$ are locally square integrable functions such that $\int_{\mathbb{R}^n} |\mathcal{F}(T)|^2 (1 + |\xi|^2)^s d\xi$ is finite, the norm $\|T\|_{H^s}$ being the square root of this expression. These spaces get larger as s decreases. For K compact in \mathbb{R}^n , let H_K^s be the vector subspace of all members of $H^s(\mathbb{R}^n)$ with support in K ; this subspace is closed and hence is complete. If U is open in \mathbb{R}^n , the space $H_{\text{com}}^s(U)$ is the union of all spaces H_K^s with K compact

¹⁷This condition takes into account Theorem 8.18, which says that the given operator differs by a smoothing operator from an operator with a symbol. If the local operator is defined by an amplitude and not a symbol, then ellipticity has not yet been defined for it.

in U , and it is given the inductive limit topology from the closed vector subspaces H_K^s . The space $H_{\text{loc}}^s(U)$ is the space of all distributions T on U such that φT is in $H_{\text{com}}^s(U)$ for all φ in $C_{\text{com}}^\infty(U)$; this space is topologized by the separating family of seminorms $T \mapsto \|\varphi T\|_{H^s}$, and a suitable countable subfamily of these seminorms suffices.

For U open in \mathbb{R}^n , it is a consequence of Theorem 5.20 that each member of $\mathcal{E}'(U)$ lies in $H_{\text{com}}^s(U)$ for some s . There is no difficulty in defining $H_{\text{com}}^s(M)$ and $H_{\text{loc}}^s(M)$ for a separable smooth manifold M in a coordinate-free way, and the result persists that $\mathcal{E}'(M)$ is the union of all the spaces $H_{\text{com}}^s(M)$ for s real.

We have seen that any generalized pseudodifferential operator on M carries $\mathcal{E}'(M)$ into $\mathcal{D}'(M)$. The basic quantitative refinement of this result is that any generalized pseudodifferential operator of order $\leq m$ carries $H_{\text{com}}^s(M)$ continuously into $H_{\text{loc}}^{s-m}(M)$.

2. Local existence for elliptic operators. We have seen that a properly supported elliptic pseudodifferential operator on a manifold has a two-sided parametrix. The existence of the left parametrix implies the regularity result that the elliptic operator maintains singular support. With the aid of the Sobolev spaces in subsection (1), one can prove that the existence of a right parametrix for an elliptic differential operator L with smooth coefficients implies a local existence theorem for the equation $L(u) = f$.

3. Pseudodifferential operators on sections of vector bundles. The theory presented above concerned pseudodifferential operators that mapped scalar-valued functions on a manifold into scalar-valued functions on the manifold. The first step of useful generalization is to pseudodifferential operators carrying vector-valued functions to vector-valued functions; these provide a natural setting for considering systems of differential equations. The next step of useful generalization is to pseudodifferential operators carrying sections of one vector bundle to sections of another vector bundle. The prototype is the differential operator d on a manifold, which carries smooth scalar-valued functions to smooth differential 1-forms. The latter, as we know from Section 4, are not to be considered as vector-valued functions on the manifold but as sections of the cotangent bundle. The ease of adapting our known techniques to handling the operator d in this setting illustrates the ease of handling the overall generalization of pseudodifferential operators to sections. In considering the equation $df = 0$, for example, we can use local coordinates and write $df(p) = \sum_i \frac{\partial f}{\partial x_i}(p) dx_i(p)$, regarding $\frac{\partial f}{\partial x_i}$ as a coefficient function for a basis vector. If $df = 0$, then each coefficient must be 0. So the partial derivatives of f in local coordinates must vanish, and f must be constant in local coordinates. Thus we have solved the equation in local coordinates. When we pass from one local coordinate system to another, aligning the basis vectors dx_i requires taking the bundle structure into account, but that is a

separate problem from understanding d locally. For a pseudodifferential operator carrying sections of one vector bundle to sections of another, the formalism is completely analogous. Locally we can regard the operator as a matrix of generalized pseudodifferential operators of the kind considered earlier in this section. One can introduce appropriate generalizations of the various notions considered in this section and work with them without difficulty. In particular, one can define principal symbol and ellipticity and can follow through the usual kind of theory of parametrices for elliptic operators, obtaining the usual kind of regularity result. In place of $H_{\text{com}}^s(M)$ and $H_{\text{loc}}^s(M)$, one works with spaces of sections $H_{\text{com}}^s(M, E)$ and $H_{\text{loc}}^s(M, E)$, E being a vector bundle.

4. Pseudodifferential operators on sections when the manifold is compact.

Of exceptional interest for applications is the situation in subsection (3) above when the underlying smooth manifold is compact. Here every pseudodifferential operator is of course properly supported, and the subscripts “com” and “loc” for Sobolev spaces mean the same thing. Three fundamental tools in this situation are the theory of “Fredholm operators,” a version of **Sobolev’s Theorem**, saying that the members of $H^s(M, E)$ have k continuous derivatives if $s > [\frac{1}{2} \dim M] + k + 1$, and **Rellich’s Lemma**, saying that the inclusion of $H^s(M, E)$ into $H^t(M, E)$ if $t < s$ carries bounded sets into sets with compact closure. An important consequence is that the kernel of an elliptic operator of order m carrying $H^s(M, E)$ to $H^{s-m}(M, F)$ is finite dimensional, the dimension being independent of s ; moreover, the image of $H^s(M, E)$ in $H^{s-m}(M, F)$ has finite codimension independent of s . The difference of the dimension of the kernel and the codimension of the image is called the **index** of the elliptic operator and plays a role in subsection (5) below.

5. Applications of the theory with sections over a compact manifold M .

In this discussion we shall freely use some terms that have not been defined in the text, putting many of them in quotation marks or boldface at their first occurrence.

5a. A prototype of the theory of subsection (4) is **Hodge theory**, which involves “higher-degree differential forms.” The operator d carries smooth forms of degree k to smooth forms of degree $k + 1$, hence is an operator from sections of one vector bundle to sections of another. If M is Riemannian, then the space of differential forms of each degree acquires an inner product, and there is a well-defined Laplacian $dd^* + d^*d$ carrying the space of forms of each degree into itself. Forms annihilated by this Laplacian are called harmonic. Roughly speaking, the theory shows that the kernel of d on the space of forms of degree k is the direct sum of the harmonic forms of degree k and the image under d of the space of forms of degree $k - 1$. Consequently “de Rham’s Theorem” allows one to identify the space of harmonic forms with the cohomology of M with coefficients in the field of scalars \mathbb{F} .

5b. For any complex manifold M , there is an operator $\bar{\partial}$ on smooth differential forms that plays the same role for the partial derivative operators $\frac{\partial}{\partial \bar{z}_j}$ that d plays for the operators $\frac{\partial}{\partial x_j}$. The same kind of analysis as in subsection (5a), when done for a compact complex manifold with a Hermitian metric and a Laplacian of the form $\bar{\partial}\bar{\partial}^* + \bar{\partial}^*\bar{\partial}$, identifies, roughly speaking, a suitable space of harmonic forms as a vector-space complement to the image of $\bar{\partial}$ in a kernel for $\bar{\partial}$.

5c. For a Riemann surface M , a holomorphic-line-bundle version of subsection (5b) leads to a proof¹⁸ of the **Riemann–Roch Theorem**, a result allowing one to compute the dimensions of various spaces of meromorphic sections on the Riemann surface. For a compact complex manifold a holomorphic-vector-bundle version of subsection (5b) leads to Hirzebruch’s generalization of the Riemann–Roch Theorem.

5d. In place of d or $\bar{\partial}$, one may use a version of a “Dirac operator” in the above kind of analysis. The result is one path that leads to the **Atiyah–Singer Index Theorem**, which relates a topological formula and an analytic formula for the index of an elliptic operator from sections of one vector bundle over the compact manifold to sections of another such bundle. This theorem has a number of applications relating topology and analysis, and the Hirzebruch–Riemann–Roch Theorem may be regarded as a special case.

BIBLIOGRAPHICAL REMARKS. There are several books on pseudodifferential operators, and the treatment here in Chapters VII and VIII has been influenced heavily by three of them: Hörmander’s Volume III of *The Analysis of Linear Partial Differential Equations*, Taylor’s *Pseudodifferential Operators*, and Treves’s Volume 1 of *Introduction to Pseudodifferential and Fourier Integral Operators*.¹⁹

All three books use the definition $\widehat{f}(\xi) = c \int_{\mathbb{R}^n} f(x)e^{-ix \cdot \xi} dx$ for the Fourier transform, where $c = 1$ for Hörmander and Treves and $c = (2\pi)^{-n/2}$ for Taylor. The definition here is $\widehat{f}(\xi) = \int_{\mathbb{R}^n} f(x)e^{-2\pi ix \cdot \xi} dx$; this change forces small differences in the constants involved in the definition of pseudodifferential operators and results like Theorems 7.22 and 8.17. Another difference in notation is that these books include a power of $i = \sqrt{-1}$ in the definition of D^α , and this text does not; inclusion of the power of i follows a tradition dating back to the work of Hermann Weyl and seems an unnecessary encumbrance at this level.

The books by Hörmander and Treves assume extensive knowledge of material in separate books by the authors concerning distributions; Taylor makes extensive use of distributions and includes a very brief summary of them in Chapter I. Treves

¹⁸Not the standard proof.

¹⁹Full references for these books and other sources may be found in the section References at the end of the book.

uses a smooth measure on a manifold in order to identify smooth functions with distributions,²⁰ but Hörmander does not.

The relevant sections of those books for the material in Sections VII.6, VIII.6, and VIII.7 are as follows: Section 18.1 of Hörmander's book, Sections II.1–II.5 and III.1 of Taylor's book, and Sections I.1–I.5 of the Treves book.

The relevant portions of the three books for the mathematics in Section VIII.8 include the following: (1) Hörmander, pp. 90–91, Taylor, Section II.6; Treves, pp. 16–18 and 47. (2) Taylor, Section VI.3; Treves, pp. 92–93. (3) Hörmander, pp. 91–92; Treves, Section I.7. (4) Hörmander, Chapter XIX; Treves, Section II.2.

A larger number of books use pseudodifferential operators for some particular kind of application, sometimes developing a certain amount of the abstract theory of pseudodifferential operators. Among these are Wells, *Differential Analysis on Complex Manifolds*, which addresses applications (5a), (5b), and (5c) above; Lawson–Michelsohn, *Spin Geometry*, which addresses application (5d) above; and Stein, *Harmonic Analysis: Real-Variable Methods, Orthogonality, and Oscillatory Integrals*, which uses pseudodifferential operators to study the behavior of holomorphic functions on the boundaries of domains in \mathbb{C}^n , as well as related topics. Hörmander's book is another one that addresses application (5d), but it does so less completely than Lawson–Michelsohn.

For a brief history of pseudodifferential operators and the relationship of the theory to results like the Calderón–Zygmund Theorem, see Hörmander, pp. 178–179. For more detail about how pseudodifferential operators capture the idea of a freezing principle, see Stein, pp. 230–231.

9. Problems

1. Verify that the unit sphere $M = S^n$ in \mathbb{R}^{n+1} , the set of vectors of norm 1, can be made into a smooth manifold of dimension n by using two charts defined as follows. One of these charts is

$$\kappa_1(x_1, \dots, x_{n+1}) = \left(\frac{x_1}{1-x_{n+1}}, \dots, \frac{x_n}{1-x_{n+1}} \right)$$

with domain $M_{\kappa_1} = S^n - \{(0, \dots, 0, 1)\}$, and the other is

$$\kappa_2(x_1, \dots, x_{n+1}) = \left(\frac{x_1}{1+x_{n+1}}, \dots, \frac{x_n}{1+x_{n+1}} \right)$$

with domain $M_{\kappa_2} = S^n - \{(0, \dots, 0, -1)\}$.

²⁰For a while, anyway.

2. Set-theoretically, the real n -dimensional projective space $M = \mathbb{R}P^n$ can be defined as the result of identifying each member x of S^n in the previous problem with its antipodal point $-x$. Let $[x] \in \mathbb{R}P^n$ denote the class of $x \in S^n$.
- (a) Show that $d([x], [y]) = \min\{|x - y|, |x + y|\}$ is well defined and makes $\mathbb{R}P^n$ into metric space such that the function $x \mapsto [x]$ is continuous and carries open sets to open sets.
- (b) For each j with $1 \leq j \leq n + 1$, define

$$\kappa_j[(x_1, \dots, x_{n+1})] = \left(\frac{x_1}{x_j}, \dots, \frac{x_{j-1}}{x_j}, \frac{x_{j+1}}{x_j}, \dots, \frac{x_{n+1}}{x_j} \right)$$

on the domain $M_{\kappa_j} = \{(x_1, \dots, x_{n+1}) \mid x_j \neq 0\}$. Show that the system $\{\kappa_j \mid 1 \leq j \leq n + 1\}$ is an atlas for $\mathbb{R}P^n$ and that the function $x \mapsto [x]$ from S^n to $\mathbb{R}P^n$ is smooth.

3. Let X be a smooth manifold.
- (a) Prove that if X is Lindelöf, or is σ -compact, or has a countable dense set, then X has an atlas with countably many charts.
- (b) Prove that if X has an atlas with countably many charts, then X is separable.
4. The **real general linear group** $G = GL(n, \mathbb{R})$ is the group of invertible n -by- n matrices with entries in \mathbb{R} , the group operation being matrix multiplication. The space of *all* n -by- n real matrices A may be identified with \mathbb{R}^{n^2} , and $GL(n, \mathbb{R})$ is then the open set where $\det A \neq 0$. As an open subset of \mathbb{R}^{n^2} , it is a smooth manifold with an atlas consisting of one chart. The coordinate functions $x_{ij}(g)$ yield the entries g_{ij} of g .
- (a) Prove that matrix multiplication, as a mapping of $G \times G$ into G , is a smooth mapping. Prove that matrix inversion, as a mapping from G into G , is smooth.
- (b) If A is a matrix with entries A_{ij} , identify A as a member of $T_g(G)$ by $A \leftrightarrow \sum_{i,j} A_{ij} \left[\frac{\partial}{\partial x_{ij}} \right]_g$. Let l_g be the diffeomorphism of G given by $l_g(h) = gh$. Define a vector field \tilde{A} by $\tilde{A}_g f = (dl_g)_1(A)(f)$ if f is defined near g . Prove that $\tilde{A}_g f = \sum_{i,j} (gA)_{ij} \frac{\partial f}{\partial x_{ij}}(g)$.
- (c) Prove that \tilde{A} is smooth and is **left invariant** in the sense of being carried to itself by all l_g 's.
- (d) Show that $c(t) = g_0 \exp tA$ is the integral curve for \tilde{A} such that $c(0) = g_0$.
- (e) Prove that if f is in $C^\infty(G)$, then $\tilde{A}f(g) = \left. \frac{d}{dt} f(g \exp tX) \right|_{t=0}$.
5. This problem concerns the existence of smooth partitions of unity on a separable smooth manifold M . Let $\{K_l\}_{l \geq 1}$ be an exhausting sequence for M . For $l = 0$, put $L_0 = K_2$ and $U_0 = K_3^o$. For $l \geq 1$, put $L_l = L_{l+2} - K_{l+1}^o$ and $U_l = K_{l+3}^o - K_l$. Each point of M lies in some L_l and has a neighborhood lying in only finitely many U_l 's.

- (a) Using the exhausting sequence, find an atlas $\{\kappa_\alpha\}$ of compatible charts such that each point of M has a neighborhood lying in only finitely many M_{κ_α} 's.
- (b) By applying Proposition 8.2 within each member of a suitable atlas as in (a), show that there exists $\eta_\alpha \in C_{\text{com}}^\infty(M_{\kappa_\alpha})$ for each α with values in $[0, 1]$ such that $\sum \eta_\alpha$ is everywhere > 0 . Normalizing, conclude that there exists $\varphi_\alpha \in C_{\text{com}}^\infty(M_{\kappa_\alpha})$ for each α with values in $[0, 1]$ such that $\sum \varphi_\alpha$ is 1 identically on M .
- (c) Prove that if K is compact in M and U is open with $K \subseteq U$, then there exists $\varphi \in C_{\text{com}}^\infty(U)$ with values in $[0, 1]$ such that φ is 1 everywhere on K .
- (d) Prove that if K is compact in M and $\{U_1, \dots, U_r\}$ is a finite open cover of K , then there exist $\varphi_j \in C_{\text{com}}^\infty(U_j)$ for $1 \leq j \leq r$ with values in $[0, 1]$ such that $\sum_{j=1}^r \varphi_j$ is 1 on K .

Problems 6–7 concern local coordinate systems on smooth manifolds.

6. Let M and N be smooth manifolds of dimensions n and k , let p be in M , suppose that $F : M \rightarrow N$ is a smooth function such that dF_p carries $T_p(M)$ onto $T_{F(p)}(N)$, and suppose that λ is a compatible chart for N about $F(p)$ such that $\lambda = (y_1, \dots, y_k)$. Prove that the functions $y_1 \circ F, \dots, y_k \circ F$ can be taken as the first k of n functions that generate a system of local coordinates near p in the sense of Proposition 8.4.
7. Let M and N be smooth manifolds of dimensions n and k , let p be in M , suppose that $F : M \rightarrow N$ is a smooth function such that dF_p is one-one, and suppose that $\psi = (y_1, \dots, y_k)$ is a compatible chart for N about $F(p)$.
 - (a) Prove that it is possible to select from the set of functions $y_1 \circ F, \dots, y_k \circ F$ a subset of n of them that generate a system of local coordinates near $F(p)$ in the sense of Proposition 8.4.
 - (b) Let $\varphi = (x_1, \dots, x_n)$ be a compatible chart for M about p . Prove that there exists a system of local coordinates (z_1, \dots, z_k) near $F(p)$ such that x_j coincides in a neighborhood of p with $z_j \circ F$ for $1 \leq j \leq n$.

Problems 8–9 concern extending Sard's Theorem (Theorem 6.35 of *Basic*) to separable smooth manifolds. Let M be an n -dimensional separable smooth manifold, and let $\{\kappa_\alpha\}$ be an atlas of charts. A subset S of M has **measure 0** if $\kappa_\alpha(S \cap M_\alpha)$ has n -dimensional Lebesgue measure 0 for all α . If $F : M \rightarrow N$ is a smooth map between smooth n -dimensional manifolds M and N , a **critical point** p of F is a point where the differential $(dF)_p$ has rank $< n$. In this case, $F(p)$ is called a **critical value**.

8. Prove that if $F : M \rightarrow N$ is a smooth map between two smooth separable n -dimensional manifolds M and N , then the set of critical values of F has measure 0 in N .
9. Prove that if $F : M \rightarrow N$ is a smooth map between two separable smooth manifolds and if $\dim M < \dim N$, then the image of F has measure 0 in N .

Problems 10–13 introduce equivalence of vector bundles, which is the customary notion of isomorphism for vector bundles with the same base space. Let $\pi : B \rightarrow M$ and $\pi' : B' \rightarrow M$ be two smooth coordinate vector bundles of the same rank n with the same field of scalars and same base space M , but with distinct bundle spaces, distinct projections, possibly distinct atlases $\mathcal{A} = \{\kappa_j\}$ and $\mathcal{A}' = \{\kappa'_k\}$ for M , distinct coordinate functions ϕ_j and ϕ'_k , and distinct transition functions $g_{jk}(x)$ and $g'_{kl}(x)$. Let $h : B \rightarrow B'$ be a fiber-preserving smooth map covering the identity map of M , i.e., a smooth map such that $h(\pi^{-1}(x)) = \pi'^{-1}(x)$ for all x in M . For each x in M , define h_x to be the smooth map obtained by restriction $h_x = h|_{\pi^{-1}(x)}$; this carries $\pi^{-1}(x)$ to $\pi'^{-1}(x)$. Say that h exhibits $\pi : B \rightarrow M$ and $\pi' : B' \rightarrow M$ as **equivalent** coordinate vector bundles if the following two conditions are satisfied:

- whenever κ_j and κ'_k are charts in \mathcal{A} and \mathcal{A}' about a point x of M , then the map

$$\bar{g}_{kj}(x) = \phi'_{k,x}{}^{-1} \circ h_x \circ \phi_{j,x}$$

of \mathbb{F}^n into itself coincides with the operation of a member of $GL(n, \mathbb{F})$,

- the map $\bar{g}_{kj} : M_{\kappa_j} \cap M_{\kappa'_k} \rightarrow GL(n, \mathbb{F})$ is smooth.

The functions $x \mapsto \bar{g}_{kj}(x)$ will be called the **mapping functions** of h .

10. Prove for coordinate vector bundles that “equivalent” is reflexive and transitive and that strictly equivalent implies equivalent.
11. Prove that if h exhibits two coordinate vector bundles $\pi : B \rightarrow M$ and $\pi' : B' \rightarrow M$ as equivalent, then the mapping functions $x \mapsto \bar{g}_{kj}(x)$ of h satisfy the conditions

$$\begin{aligned} \bar{g}_{kj}(x)g_{ji}(x) &= \bar{g}_{ki}(x) & \text{for } x \in M_{\kappa_i} \cap M_{\kappa_j} \cap M_{\kappa'_k}, \\ g'_{lk}(x)\bar{g}_{kj}(x) &= \bar{g}_{lj}(x) & \text{for } x \in M_{\kappa_j} \cap M_{\kappa'_k} \cap M_{\kappa'_l}. \end{aligned}$$

12. Suppose that $\pi : B \rightarrow M$ and $\pi' : B' \rightarrow M$ are two smooth coordinate vector bundles of the same rank n with the same field of scalars relative to atlases $\mathcal{A} = \{\kappa_j\}$ and $\mathcal{A}' = \{\kappa'_k\}$ of M .
 - (a) If smooth functions $x \mapsto \bar{g}_{kj}(x)$ of $M_{\kappa_j} \cap M_{\kappa'_k}$ into $GL(n, \mathbb{F})$ are given that satisfy the displayed conditions in Problem 11, prove that there exists at most one equivalence $h : B \rightarrow B'$ of coordinate vector bundles having $\{\bar{g}_{kj}\}$ as mapping functions and that it is given by $h(\phi_{j,x}(y)) = \phi'_{k,x}\bar{g}_{kj}(x)(y)$.
 - (b) Prove that “equivalent” for coordinate vector bundles is symmetric, and conclude that “equivalent” is an equivalence relation whose equivalence classes are unions of equivalence classes under strict equivalence. (Educational note: Therefore the notion of **equivalent vector bundles** is well defined.)
13. Suppose that $\pi : B \rightarrow M$ and $\pi' : B' \rightarrow M$ are two smooth coordinate vector bundles of the same rank n with the same field of scalars relative to atlases $\mathcal{A} = \{\kappa_j\}$ and $\mathcal{A}' = \{\kappa'_k\}$ of M , and suppose that smooth functions $x \mapsto \bar{g}_{kj}(x)$ of $M_{\kappa_j} \cap M_{\kappa'_k}$ into $GL(n, \mathbb{F})$ are given that satisfy the displayed conditions in Problem 11.

- (a) Define a smooth mapping h_{kj} from $\pi^{-1}(M_{\kappa_j} \cap M_{\kappa'_k})$ in B to $\pi'^{-1}(M_{\kappa_j} \cap M_{\kappa'_k})$ as follows: If b is in B with $x = \pi(b)$ in $M_{\kappa_j} \cap M_{\kappa'_k}$, let $\pi_j(b) = \phi_{j,x}^{-1}(b) \in \mathbb{F}^n$, and set

$$h_{kj}(b) = \phi'_{k,x} \bar{g}_{kj}(x)(p_j(b)).$$

Prove that $\{h_{kj}\}$ is consistently defined as one moves from chart to chart, i.e., that if x lies also in $M_{\kappa_i} \cap M_{\kappa'_k}$, then $h_{kj}(b) = h_{li}(b)$, and conclude that the functions h_{kj} piece together as a single smooth function $h : B \rightarrow B'$.

- (b) Prove that the functions $x \mapsto \bar{g}_{kj}(x)$ coincide with the mapping functions of h , and conclude that the existence of functions satisfying the displayed conditions in Problem 11 is necessary and sufficient for equivalence.

CHAPTER IX

Foundations of Probability

Abstract. This chapter introduces probability theory as a system of models, based on measure theory, of some real-world phenomena. The models are measure spaces of total measure 1 and usually have certain distinguished measurable functions defined on them.

Section 1 begins by establishing the measure-theoretic framework and a short dictionary for passing back and forth between terminology in measure theory and terminology in probability theory. The latter terminology includes events, random variables, mean, probability distribution of a random variable, and joint probability distribution of several random variables. An important feature of probability is that it is possible to work with random variables without any explicit knowledge of the underlying measure space, the joint probability distributions of random variables being the objects of importance.

Section 2 introduces conditional probability and uses that to motivate the mathematical definition of independence of events. In turn, independence of events leads naturally to a definition of independent random variables. Independent random variables are of great importance in the subject and play a much larger role than their counterparts in abstract measure theory. Examples at the end of the section indicate the extent to which functions of independent random variables can remain independent. The techniques in the examples are of use in the subject of statistical inference, which is introduced in Section 10.

Section 3 states and proves the Kolmogorov Extension Theorem, a foundational result allowing one to create stochastic processes involving infinite sets of times out of data corresponding to finite subsets of those times. A special case of the theorem provides the existence of infinite sets of independent random variables with specified probability distributions.

Section 4 establishes the celebrated Strong Law of Large Numbers, which says that the Cesàro sums of a sequence of identically distributed independent random variables with finite mean converge almost everywhere to a constant random variable, the constant being the mean. This is a theorem that is vaguely known to the general public and is widely misunderstood. The proof is based on Kolmogorov's inequality.

Sections 5–8 provide background for the Central Limit Theorem, whose statement and proof are in Section 9. Section 5 discusses three successively weaker kinds of convergence for random variables—almost sure convergence, convergence in probability, and convergence in distribution. Convergence in distribution will be the appropriate kind for the Central Limit Theorem. Section 6 contains the Portmanteau Lemma, which gives some equivalent formulations of convergence in distribution, Section 7 introduces characteristic functions as Fourier transforms of probability distributions, and Section 8 proves the Lévy Continuity Theorem, which formulates convergence in distribution in terms of characteristic functions.

Section 9 contains the statement and proof of the Central Limit Theorem, followed by some simple examples. This theorem is the most celebrated result in probability theory and has many applications in mathematics and other fields.

Section 10 is a brief introduction to the subject of statistical inference, showing how the Central Limit theorem plays a role in practice through the t test of W. S. Gosset.

1. Measure-Theoretic Foundations

Although notions of probability have been around for hundreds of years, it was not until the twentieth century, with the introduction of Lebesgue integration, that the foundations of probability theory could be established in any great generality. The early work on foundations was done between 1929 and 1933 chiefly by A. N. Kolmogorov and partly by M. Fréchet.

First of all, the idea is that probability theory consists of *models* for some experiences in the real world. Second of all, these experiences are *statistical* in nature, involving repetition. Thus one attaches probability $1/2$ to the outcome of “heads” for one flip of a standard coin based on what has been observed over a period of time. One even goes so far as to attach probabilities to outcomes that one can think of repeating even if they cannot be repeated as a practical matter, such as the probability that a particular person will die from a certain kind of surgery. But one does not try to incorporate probabilities into the theory for contingencies that cannot remotely be regarded as repeatable. The philosopher R. Carnap has asked, “What is the probability that the fair coin I have just tossed has come up ‘heads’?” He would insist that the answer is 0 or 1, certainly not $1/2$. Mathematical probability theory leaves his question as something for philosophers and does not address it.

The initial situation that is to be modeled is that of an experiment to be performed; the experiment may be really simple, as with a single coin toss, or it may have stages to it that may or may not be related to each other. For the moment let us suppose that the number of stages is finite; later we shall relax this condition. To fix the ideas, let us think of the outcome as a point in some Euclidean space. Forcing the outcome to be a point in a Euclidean space may not at first seem very natural for a single toss of a coin, but we can, for example, identify “heads” with 1 and “tails” with 0 in \mathbb{R}^1 . In any case, the experiment has a certain range of conceivable outcomes, and these outcomes are to be disjoint from one another. Initially we let Ω be the set of these conceivable outcomes. If an outcome occurs when conditions belonging to a set A are satisfied, one says that the **event** A has taken place.

We imagine that probabilities have somehow been attached to the individual outcomes, and to aggregates of them, on the basis of some experimental data. Using a frequency interpretation of probability, one is led to postulate that probability in the model of this experiment is a nonnegative additive set function on some

system of subsets of Ω that assigns the value 1 to Ω itself. Without measure theory as a historical guide, one might be hard pressed to postulate complete additivity as well, but in retrospect complete additivity is not a surprising condition to impose.

At any rate, the model of the experiment within probability theory uses a measure space (Ω, \mathcal{A}, P) , normally with total measure $P(\Omega)$ equal to 1, with one or more measurable functions on Ω to indicate the result of the experiment. One way of setting up (Ω, \mathcal{A}, P) is as we just did—to let Ω be the set of all possible outcomes, i.e., all possible values of the measurable functions that give the result of the experiment. Events are then simply measurable sets of outcomes, and the measure P gives the probabilities of various sets of outcomes. Yet this is not the only way, and successful work in the subject of probability theory requires a surprising indifference to the nature of the particular Ω used to model a particular experiment.

We can give a rather artificial example right now, in the context of a single toss of a standard coin, of how distinct Ω 's might be used to model the same experiment, and we postpone to the last two paragraphs of this section and to the proof of Theorem 9.8 any mention of more natural situations in which one wants to allow distinct Ω 's in general. The example occurs when the experiment is a single flip of a standard coin. Let us identify “heads” with the real number 1 and “tails” with the real number 0. Centuries of data and of processing the data have led to a consensus that the probabilities are to be $1/2$ for each of the two possible outcomes, 1 and 0. We can model this situation by taking Ω to be the set $\{1, 0\}$ of outcomes, \mathcal{A} to consist of all subsets of Ω , and P to assign weight $1/2$ to each point of Ω . The function f indicating the result of the experiment is the identity function, with $f(\omega) = 1$ if $\omega = 1$ and with $f(\omega) = 0$ if $\omega = 0$. But it would be just as good to take any other measure space (Ω, \mathcal{A}, P) with $P(\Omega) = 1$ and to suppose that there is some measurable subset A with $P(A) = 1/2$. The measurable function f modeling the experiment has $f(\omega) = 1$ if ω is in A and $f(\omega) = 0$ if not.

The problem of how to take real-world data and to extract probabilities in preparation for defining a model is outside the domain of probability theory. This involves a statistical part that obtains and processes the data, identifies levels of confidence in the accuracy of the data, and assesses the effects of errors made in obtaining the data accurately. Also it may involve making some value judgments, such as what confidence levels to treat as decisive, and such value judgments are perhaps within the domain of politicians. In addition, there is a fundamental philosophical question in whether the model, once constructed, faithfully reflects reality. This question is similar to the question of whether mathematical physics reflects the physics of the real world, but with one complication: in physics there is always the possibility that a single experimental result will disprove the model, whereas probability gives no prediction that can be disproved by a single

experimental result.

Apart from a single toss of a coin, another simple experiment whose outcome can be expressed in terms of a single real number is the selection of a “random” number from $[0, 2]$. The word “random” in this context, when not qualified in some way, insists as a matter of definition that the experiment is governed by normalized Lebesgue measure, that the probability of picking a number within a set A is the Lebesgue measure of A divided by the Lebesgue measure of $[0, 2]$. If we take Ω to be $[0, 2]$, \mathcal{A} to be the Borel sets, and P to be $\frac{1}{2} dx$ and if we use the identity function as the measurable function telling the outcome, then we have completely established a model.

The theory needed for setting up a model that incorporates given probabilities is normally not so readily at hand, since one is quite often interested potentially in infinitely many stages to an experiment and the given data concern only finitely many stages at a time. In many cases of this kind, one invokes a fundamental theorem of Kolmogorov to set up a measure space that can allow the set of distinguished measurable functions to be infinite in number. We shall state and prove this theorem in Section 3.

In the meantime let us take the measure space (Ω, \mathcal{A}, P) with $P(\Omega) = 1$ as given to us. We refer to (Ω, \mathcal{A}, P) or simply (Ω, P) as a **probability space**. Probability theory has its own terminology. An **event** is a measurable set, thus a set in the σ -algebra \mathcal{A} . One speaks of the “probability of an event,” which means the P measure of the set. The language used for an event is often slightly different from the ordinary way of defining a set. With the random-number example above, one might well speak of the probability of the “event that the random number lies in $[1/2, 1]$ ” when a more literal description is that the event *is* $[1/2, 1]$. It is not a large point. The probability in either case, of course, is $1/4$.

Let A and B be events. The event $A \cap B$ is the simultaneous occurrence of A and B . The event $A \cup B$ is the event that at least one of A and B occurs. The event A^c is the nonoccurrence of the event A . If $A = \emptyset$, event A is impossible; if $A = \Omega$, event A must occur. Containment $B \subseteq A$ means that from the occurrence of event B logically follows the occurrence of event A . Two events A and B are incompatible if $A \cap B = \emptyset$. A set-theoretic partitioning C of Ω as a disjoint union $\Omega = \bigcup_{k=1}^n A_k$ corresponds to an experiment C consisting of determining which of the events A_1, \dots, A_n occurs. And so on.

A **random variable** is a real-valued measurable function on Ω . With the random-number example, a particular random variable is the number selected. This is the function f that associates the real number ω to the member ω of the space Ω . The word “random” in the name “random variable” refers to the fact that its value depends on which possibility in Ω is under consideration. Some latitude needs to be made in the definition of measurable function to allow a function taking on values “heads” and “tails” to be a random variable, but this point will

not be important for our purposes.¹ As we shall see, the random variables that yield the result of the defining experiment of a probability model are, in a number of important cases, coordinate functions on a set Ω given as a product, and random variables are often indicated by letters like x suitable for coordinates.²

The **mean** or **expectation** or **expected value** $E(x)$ of the random variable x is motivated by a computation in the especially simple case that Ω contains finitely many outcomes/points and $P(A)$ is computed for an event by adding the weights attached to the outcomes ω of A . If ω is an outcome, the value of x at ω is $x(\omega)$, and this outcome occurs with probability $P(\{\omega\})$. Summing over all outcomes, we obtain $\sum_{\omega \in \Omega} x(\omega)P(\{\omega\})$ as a reasonable notion of the expected value. This sum suggests a Lebesgue integral, and accordingly the definition in the general case is that $E(x) = \int_{\Omega} x(\omega) dP(\omega)$. Probabilists say that $E(x)$ **exists** if x is *integrable*; cases in which the Lebesgue integral exists and is infinite are excluded.

There is a second way of computing the mean. When Ω is a finite set as above, we can group all the terms in $\sum_{\omega \in \Omega} x(\omega)P(\{\omega\})$ for which $x(\omega)$ takes a particular value c and then sum on c . The regrouped value of the sum is $\sum_c cP(\{\omega \mid x(\omega) = c\})$. The corresponding formula in the general case involves the **probability distribution** of x , the Stieltjes measure μ_x on the Borel sets of the line \mathbb{R} defined by

$$\mu_x(A) = P(\{\omega \in \Omega \mid x(\omega) \in A\}).$$

The name “distribution” is traditional in probability theory to emphasize the way in which mass has been spread in some fashion, and the adjective “probability” refers to the fact that this measure has total mass $\mu_x(\mathbb{R}) = P(\Omega) = 1$. Although Stieltjes measures are indeed distributions in the sense of Chapter V, it is not at all helpful to think of them in this way in probability theory. Thus we shall usually retain the adjective “probability” to head off any confusion.

The notion of μ_x , but not the name, was introduced in Section VI.10 of *Basic*. The formula for the mean in terms of the probability distribution of x is $E(x) = \int_{\mathbb{R}} x d\mu_x$; the justification for this formula lies in the following proposition, which was proved in *Basic* as Proposition 6.56a and which we re-prove here.

Proposition 9.1. If $x : \Omega \rightarrow \mathbb{R}$ is a random variable on a probability space

¹We return to this point in Section 3, where it will influence the hypotheses of the fundamental theorem of Kolmogorov.

²In his book *Measure Theory* Doob writes on p. 179, “An attentive reader will observe . . . that in other chapters a function is f or g , and so on, whereas in this chapter [on probability] a function is more likely to be x or y , and so on, at the other end of the alphabet. This difference is traditional, and is one of the principal features that distinguishes probability from the rest of measure theory.”

(Ω, P) and if μ_x is the probability distribution of x , then

$$\int_{\Omega} \Phi(x(\omega)) dP(\omega) = \int_{\mathbb{R}} \Phi(t) d\mu_x(t)$$

for every nonnegative Borel measurable function $\Phi : \mathbb{R} \rightarrow \mathbb{R}$. The formula extends linearly to the case in which the condition “nonnegative” on Φ is dropped if the integrals for $\Phi^+ = \max(\Phi, 0)$ and $\Phi^- = -\min(\Phi, 0)$ are both finite. It extends to complex-valued Φ if the integral for $|\Phi|$ is finite.

PROOF. When Φ is the indicator function I_A of a Borel set A of \mathbb{R} , the two sides of the identity are $P(x^{-1}(A))$ and $\mu_x(A)$, and these are equal by definition of μ_x . We can pass to nonnegative simple functions by linearity and then to general nonnegative Borel measurable functions Φ by monotone convergence. \square

The qualitative conclusion of Proposition 9.1 is by itself important: the mean of any function of a random variable can be computed in terms of the probability distribution of the random variable—without reference to the underlying measure space Ω .

The expression for $E(x)$ arising from Proposition 9.1 can often be written as a “Stieltjes integral,” which is a simple generalization of the Riemann integral,³ and thus the proposition in principle gives a way of computing means without Lebesgue integration.⁴

Instead of working with the Stieltjes measure μ_x , one can work with an associated monotone function on \mathbb{R} . The particular monotone function used by probabilists is the **cumulative distribution function** of x , defined by

$$F_x(t) = \mu_x((-\infty, t]).$$

The cumulative distribution function of x differs only by the additive constant $\mu_x((-\infty, 0])$ from the distribution function introduced in Section VI.8 of *Basic*; the value of the latter monotone function at t was

$$\begin{cases} -\mu((x, 0]) & \text{if } x \leq 0 \\ \mu((0, x]) & \text{if } x \geq 0. \end{cases}$$

When the probability measure μ_x is absolutely continuous with respect to Lebesgue measure, we can write $\mu_x = f_x(t) dt$ for a function f_x by the Radon–Nikodym Theorem.⁵ Such a function f_x , which is determined up to sets of

³Stieltjes integration is developed briefly in the problems at the end of Chapter III of *Basic*.

⁴Consequently the resulting formula for means is handy pedagogically and is often exploited in elementary probability books.

⁵Corollary 7.10 or Theorem 9.16 of *Basic*.

measure 0, is called the **density** of the random variable x . In terms of monotone functions, a density exists if and only if the cumulative distribution function is absolutely continuous (for example, when it has a continuous derivative), and in this case the density is the pointwise derivative a.e. of the cumulative distribution function. If x has a density f_x , the formula for the mean becomes $E(x) = \int_{\mathbb{R}} t f_x(t) dt$; this conclusion is just Proposition 9.1 for the Borel function $\Phi(t) = t$. More generally, $E(\Phi(x)) = \int_{\mathbb{R}} \Phi(t) f_x(t) dt$ for any Φ as in Proposition 9.1.

A set of random variables is said to be **identically distributed** if all of them have the same Stieltjes measure as probability distribution. As a consequence of Proposition 9.1, identically distributed random variables have the same mean. We shall make serious use of identically distributed random variables starting in Section 4.

Although Proposition 9.1 allows us to compute the mean of any Borel function of a random variable in terms of the probability distribution of the random variable, it does not help us when we have to deal with more than one random variable. The appropriate device for more than one random variable is a “joint probability distribution.” If x_1, \dots, x_N are random variables, define, for each Borel set A in \mathbb{R}^N ,

$$\mu_{x_1, \dots, x_N}(A) = P(\{\omega \in \Omega \mid (x_1(\omega), \dots, x_N(\omega)) \in A\}).$$

Then μ_{x_1, \dots, x_N} is a Borel measure on \mathbb{R}^N with $\mu_{x_1, \dots, x_N}(\mathbb{R}^N) = 1$. It is called the **joint probability distribution** of x_1, \dots, x_N . Referring to the definition, we see that we can obtain the joint probability distribution of a subset of x_1, \dots, x_N by dropping the relevant variables: for example, dropping x_N enables us to pass from the joint probability distribution of x_1, \dots, x_N to the joint probability distribution of x_1, \dots, x_{N-1} , the formula being

$$\mu_{x_1, \dots, x_{N-1}}(B) = \mu_{x_1, \dots, x_N}(B \times \mathbb{R}).$$

Proposition 9.2. If x_1, \dots, x_N are random variables on a probability space (Ω, P) and if μ_{x_1, \dots, x_N} is their joint probability distribution, then

$$\int_{\Omega} \Phi(x_1(\omega), \dots, x_N(\omega)) dP(\omega) = \int_{\mathbb{R}^N} \Phi(t_1, \dots, t_N) d\mu_{x_1, \dots, x_N}(t_1, \dots, t_N)$$

for every nonnegative Borel measurable function $\Phi : \mathbb{R}^N \rightarrow \mathbb{R}$. The formula extends linearly to the case in which the condition “nonnegative” on Φ is dropped if the integrals for $\Phi^+ = \max(\Phi, 0)$ and $\Phi^- = -\min(\Phi, 0)$ are both finite. It extends to complex-valued Φ if the integral for $|\Phi|$ is finite.

PROOF. In (a), when Φ is the indicator function I_A of a Borel set A of \mathbb{R}^N , the two sides of the identity are $P((x_1, \dots, x_N)^{-1}(A))$ and $\mu_{x_1, \dots, x_N}(A)$, and these

are equal by definition of μ_{x_1, \dots, x_N} . We can pass to nonnegative simple functions by linearity and then to general nonnegative Borel measurable functions Φ by monotone convergence. \square

As with Proposition 9.1, the qualitative conclusion of Proposition 9.2 is by itself important: the mean of any function of N random variables can be computed in terms of their joint probability distribution—without reference to the underlying measure space Ω . For example the product of the N random variables is a function of them, and therefore

$$E(x_1 \cdots x_N) = \int_{\mathbb{R}^N} t_1 \cdots t_N d\mu_{x_1, \dots, x_N}(t_1, \dots, t_N).$$

When the probability measure μ_{x_1, \dots, x_N} is absolutely continuous with respect to Lebesgue measure, we can write $\mu_{x_1, \dots, x_N} = f_{x_1, \dots, x_N}(t) dt$ for a function f_{x_1, \dots, x_N} by the Radon–Nikodym Theorem.⁶ Such a function f_{x_1, \dots, x_N} , which is determined up to sets of measure 0, is called the **joint probability density** of the random variables x_1, \dots, x_N .

The possibility of making such computations without explicitly using Ω has the effect of changing the emphasis in the subject. Often it is not that one is given such-and-such probability space and such-and-such random variables on it. Instead, one is given some random variables and, if not their precise joint probability distribution, at least some properties of it. Accordingly, we can ask, What Borel measures μ on \mathbb{R}^N with $\mu(\mathbb{R}^N) = 1$ are joint probability distributions of some family x_1, \dots, x_N of N random variables on some probability space (Ω, P) ?

The answer is, *all* Borel measures μ with $\mu(\mathbb{R}^N) = 1$. In fact, we have only to take $(\Omega, P) = (\mathbb{R}^N, \mu)$ and let x_j be the j^{th} coordinate function $x_j(\omega_1, \dots, \omega_N) = \omega_j$ on \mathbb{R}^N . Substituting into the definition of joint probability distribution, we see that the value of the joint probability distribution μ_{x_1, \dots, x_N} on a Borel set A in \mathbb{R}^N is

$$\begin{aligned} \mu_{x_1, \dots, x_N}(A) &= \mu(\{\omega \in \mathbb{R}^N \mid (x_1(\omega), \dots, x_N(\omega)) \in A\}) \\ &= \mu(\{\omega \in \mathbb{R}^N \mid (\omega_1, \dots, \omega_N) \in A\}) = \mu(A). \end{aligned}$$

Thus μ_{x_1, \dots, x_N} equals the given measure μ .

Even for $N = 1$, this conclusion is useful. In the proof of the Central Limit Theorem later in this chapter, we shall encounter the “normal distribution on \mathbb{R}^1 with mean 0 and variance σ^2 .” This is the Stieltjes measure μ on \mathbb{R} defined by

$$\mu(A) = \frac{1}{\sigma\sqrt{2\pi}} \int_A e^{-u^2/(2\sigma^2)} du$$

⁶Theorem 9.16 of *Basic*.

for every Borel set A , i.e., the absolutely continuous Stieltjes measure with density $(\sigma\sqrt{2\pi})^{-1} e^{-u^2/(2\sigma^2)}$; it has $\mu(\mathbb{R}) = 1$. The above remarks show how to define a random variable with this particular probability distribution: the underlying space is $\Omega = \mathbb{R}$, the underlying probability measure is this μ , and the random variable is the coordinate function x on \mathbb{R} .

2. Independent Random Variables

The notion of independence of events in probability theory is a matter of definition, but the definition tries to capture the intuition that one might attach to the term. Thus one seeks a mathematical condition saying that a set of attributes determining a first event has no influence on a second event and vice versa. Kolmogorov writes,⁷

Historically, the independence of experiments and random variables represents the very mathematical concept that has given the theory of probability its peculiar stamp. The classical work of LaPlace, Poisson, Tchebychev, Liapounov, Mises, and Bernstein is actually dedicated to the fundamental investigation of series of independent random variables. . . . We thus see, in the concept of independence, at least the germ of the peculiar type of problem in probability theory. . . . In consequence, one of the most important problems in the philosophy of the natural sciences is—in addition to the well-known one regarding the essence of the concept of probability itself—to make precise the premises which would make it possible to regard any given real events as independent.

The path to discovering the mathematical condition that captures independence of events begins with “conditional probability.” Let A and B be two events, and assume that $P(B) > 0$. Think of A as a variable. The **conditional probability** of A given B , written $P(A | B)$, is to be a new probability measure, as A varies, and is to be a version of P adjusted to take into account that B happens. These words are interpreted to mean that a normalization is called for, and the corresponding definition is therefore

$$P(A | B) = \frac{P(A \cap B)}{P(B)}.$$

In measure-theoretic terms, we pass from the measure space (Ω, \mathcal{A}, P) to the measure space $(B, \mathcal{A} \cap B, P((\cdot) \cap B)/P(B))$. Conditional probabilities $P(A | B)$ are left undefined when $P(B) = 0$.

⁷In his *Foundations of the Theory of Probability*, second English edition, pp. 8–9.

The intuition concerning independence of A and B is that the occurrence of B is not to influence the probability of A . Thus two events A and B are to be independent, at least when $P(B) > 0$, if $P(A) = P(A | B)$. This condition initially looks asymmetric, but if we substitute the definition of conditional probability, we find that the condition is $P(A) = \frac{P(A \cap B)}{P(B)}$, hence that

$$P(A \cap B) = P(A)P(B).$$

This condition is symmetric, and it allows us to drop the assumption that $P(B) > 0$. We therefore define the events A and B to be **independent** if $P(A \cap B) = P(A)P(B)$.

As the quotation above from Kolmogorov indicates, the question of the extent to which this definition of independence captures from nature our intuition for what the term should mean is a deep fundamental problem in the philosophy of science. We shall not address it further.

But a word of caution is appropriate. The assumption of mathematical independence carries with it far-reaching consequences, and it is not to be treated lightly. Members of the public all too frequently assume independence without sufficient evidence for it. Here are two examples that made national news in the first decade of the twenty-first century.

EXAMPLES.

(1) In the murder trial of a certain sports celebrity, a criminalist presented evidence that three characteristics of some of the blood at the scene matched the defendant's blood, and the question was to quantify the likelihood of this match if the defendant was not the murderer. Two of the three characteristics amounted to the usual blood type and Rh factor, and the criminalist said that half the people in the population had blood with these characteristics. The third characteristic was something more unusual, and he asserted that only 4% of the population had blood with this characteristic. He concluded that only 2% of the population had blood for which these three characteristics matched those in the defendant's blood and the blood at the scene. The defense attorney jumped on the criminalist, asking how he arrived at the 2% figure, and received a confirmation that the criminalist had simply multiplied the probability .5 for the blood type and Rh factor by the .04 for the third characteristic. Upon being questioned further, the criminalist acknowledged that he had multiplied the probabilities because he could not see that these characteristics had anything to do with each other. The defense attorney elicited a further acknowledgment that the criminalist was aware of no studies of the joint probability distribution. The criminalist's testimony was thus discredited, and the jurors could ignore it. What the criminalist could have said, but did not, was that anyway at most 4% of the population had blood with

those three characteristics because of that third characteristic alone; that assertion would not have required any independence.

(2) In the 2004 presidential election, some malfunctions involving electronic voting machines occurred in three states in a particular way that seemed to favor one of the two main candidates. One national commentator who pursued this story rounded up an expert who examined closely what happened in one of the states and came up with a rather small probability of about .1 for the malfunction to have been a matter of pure chance. Seeing that the three states were widely separated geographically and that communication between officials of the different states on Election Day was unlikely, the commentator apparently concluded in his mind that the three events were independent. So he multiplied the probabilities and announced to the public that the probability of this malfunction in all three states on the basis of pure chance was a decisively small .001. What he ignored was that the machines in the three states were all made by the same company; so the assumption of independence was doubtful.

Of more importance for our purposes than independence of events is the notion of independence of random variables. Tentatively let us say that two random variables x and y on a probability space (Ω, P) are defined to be independent if $\{x(\omega) \in A\}$ and $\{y(\omega) \in B\}$ are independent events for every pair of Borel subsets A and B of \mathbb{R} . Substituting the definition of independent events, we see that the condition is that

$$P(\{\omega \mid (x(\omega), y(\omega)) \in A \times B\}) = P(\{\omega \mid x(\omega) \in A\})P(\{\omega \mid y(\omega) \in B\})$$

for every pair of Borel subsets of \mathbb{R} . We can rewrite this condition in terms of their probability distributions as

$$\mu_{x,y}(A \times B) = \mu_x(A)\mu_y(B).$$

In other words, the measure $\mu_{x,y}$ on \mathbb{R}^2 agrees with the product measure $\mu_x \times \mu_y$ on measurable rectangles. By Proposition 5.45 of *Basic*, the two measures must then agree on all Borel sets of \mathbb{R}^2 . Conversely if the two measures agree on all Borel sets of \mathbb{R}^2 , then they agree on all measurable rectangles. We therefore adopt the following definition: two random variables x and y on a probability space (Ω, P) are **independent** if their joint probability distribution is the product of their individual probability distributions, i.e., if $\mu_{x,y} = \mu_x \times \mu_y$.

One can go through a similar analysis, starting from conditional probability involving N events, and be led to a similar result for N random variables. The upshot is that N random variables x_1, \dots, x_N on a probability space (Ω, P) are defined to be **independent** if their joint probability distribution μ_{x_1, \dots, x_N} is the N -fold product of the individual probability distributions $\mu_{x_1}, \dots, \mu_{x_N}$. An

infinite collection of random variables is said to be **independent** if every finite subcollection of them is independent.

We can ask whether arbitrarily large finite numbers of independent random variables exist on some probability space with specified probability distributions, and the answer is “yes.” This question is a special case of the one near the end of Section 1. If we are given N Borel measures μ_1, \dots, μ_N on \mathbb{R} and we seek independent random variables with these measures as their respective individual probability distributions, we form the product measure $\mu = \mu_1 \times \dots \times \mu_N$. Then the observation at the end of Section 1 shows us that if we take (\mathbb{R}^N, μ) as a probability space and if we define N random variables on \mathbb{R}^N to be the N coordinate functions, then the N random variables have μ as joint probability distribution. Since μ is a product, the random variables are independent.

The question is more subtle if asked about infinitely many independent random variables. If, for example, we are given an infinite sequence of Borel measures on \mathbb{R} , we do not yet have tools for obtaining a probability space with a sequence of independent random variables having those individual probability distributions.⁸ We can handle an arbitrarily large finite number, and we need a way to pass to the limit. The passage to the limit for this situation is the simplest nontrivial application of the fundamental theorem of Kolmogorov that was mentioned in Section 1. The theorem will be stated and proved in Section 3.

We conclude this section with two propositions and some examples concerning independence.

Proposition 9.3. If x_1, \dots, x_N are independent random variables on a probability space, then $E(x_1 \cdots x_N) = E(x_1) \cdots E(x_N)$.

PROOF. If μ_{x_1, \dots, x_N} is the joint probability distribution of x_1, \dots, x_N , then it was observed after Proposition 9.2 that

$$E(x_1 \cdots x_N) = \int_{\mathbb{R}^N} t_1 \cdots t_N d\mu_{x_1, \dots, x_N}(t_1, \dots, t_n). \quad (*)$$

The independence means that $d\mu_{x_1, \dots, x_N}(t_1, \dots, t_n) = d\mu_{x_1}(t_1) \cdots d\mu_{x_N}(t_N)$. Then the integral on the right side of (*) splits as the product of N integrals, the j^{th} factor being $\int_{\mathbb{R}} t_j d\mu_{x_j}(t_j)$. This j^{th} factor equals $E(x_j)$, and the proposition follows. \square

Proposition 9.4. Let

$$x_1, \dots, x_{k_1}, x_{k_1+1}, \dots, x_{k_2}, x_{k_2+1}, \dots, x_{k_3}, \dots, x_{k_{m-1}+1}, \dots, x_{k_m}$$

⁸There is one trivial case that we can already handle. An arbitrary set of constant random variables can always be adjoined to an independent set, and the independence will persist for the enlarged set.

be k_m independent random variables on a probability space, define $k_0 = 0$, and suppose that $F_j : \mathbb{R}^{k_j - k_{j-1}} \rightarrow \mathbb{R}$ is a Borel function for each j with $1 \leq j \leq m$. Then the m random variables $F_j(x_{k_{j-1}+1}, \dots, x_{k_j})$ are independent.

REMARKS. That is, functions of disjoint subsets of a set of independent random variables are independent.

PROOF. Put $y_j = (x_{k_{j-1}+1}, \dots, x_{k_j})$, and define $y = (y_1, \dots, y_m)$ and $F = (F_1, \dots, F_m)$. Let \mathbb{R}_j be the copy of $\mathbb{R}^{k_j - k_{j-1}}$ corresponding to variables numbered $k_{j-1} + 1$ through k_j , and regard the probability distribution $\mu_{F_j(y_j)}$ of F_j as a measure on \mathbb{R}_j . What needs proof is that

$$\mu_{F(y)} = \mu_{F_1(y_1)} \times \cdots \times \mu_{F_m(y_m)}. \quad (*)$$

Both sides of this expression are Borel measures on \mathbb{R}^{k_m} . On any product set $A = A_1 \times \cdots \times A_m$, where A_j is a Borel subset of \mathbb{R}_j , we have

$$\begin{aligned} \mu_{F(y)}(A) &= P(\{\omega \mid F(y(\omega)) \in A\}) \\ &= P(\{\omega \mid F_j(y_j(\omega)) \in A_j \text{ for all } j\}) \\ &= P(\{\omega \mid y_j(\omega) \in F_j^{-1}(A_j) \text{ for all } j\}) \\ &= \prod_{j=1}^m P(\{\omega \mid y_j(\omega) \in F_j^{-1}(A_j)\}) \quad \text{by the assumed independence} \\ &= \prod_{j=1}^m P(\{\omega \mid F_j(y_j)(\omega) \in A_j\}) \\ &= \prod_{j=1}^m \mu_{F_j(y_j)}(A_j). \end{aligned}$$

Consequently the two sides of (*) are equal on all Borel sets. \square

Now let us come to some examples. Proposition 9.4 is a useful tool for generating independent random variables, as Examples 1 and 2 will show. On the other hand, independence of random variables is not as robust a notion as one might hope, according to Example 3a. Examples 3b and 3c are motivated by Example 3a and develop a change-of-variables technique that is useful in Section 10. Example 4 is a complement to Example 3a, showing that sometimes independence occurs in new random variables defined in terms of other random variables even when Examples 1 and 2 do not apply; this situation will be of critical importance in Section 10.

EXAMPLES.

(1) If x_1, x_2, \dots, x_N are independent random variables and F_1, F_2, \dots, F_N are Borel functions on \mathbb{R}^1 , then $F_1(x_1), F_2(x_2), \dots, F_N(x_N)$ are independent random variables.

(2) If x_1, \dots, x_N are independent random variables and if $s_j = x_1 + \dots + x_j$, then the two random variables s_j and $s_N - s_j$ are independent because s_j depends only on x_1, \dots, x_j and $s_N - s_j$ depends only on x_{j+1}, \dots, x_N .

(3) Suppose that two independent random variables x_1 and x_2 are given, and suppose that we form two new random variables $y_1 = f_1(x_1, x_2)$ and $y_2 = f_2(x_1, x_2)$. Let us focus on what happens under the change of variables. For simplicity suppose that the vector-valued function $f = \begin{pmatrix} f_1 \\ f_2 \end{pmatrix}$ is smooth and is invertible with smooth inverse given by $g = \begin{pmatrix} g_1 \\ g_2 \end{pmatrix}$. Suppose also that x_1 and x_2 both have densities: $\mu_{x_1} = h_1(t_1) dt_1$ and $\mu_{x_2} = h_2(t_2) dt_2$. The joint probability distribution of x_1 and x_2 is $\mu_{x_1, x_2} = h_1(t_1)h_2(t_2) dt_1 dt_2$ because of the assumed independence, and thus x_1 and x_2 have $h_1(t_1)h_2(t_2)$ as joint probability density. Proposition 9.2 shows that

$$\int_{\Omega} \Phi(x_1(\omega), x_2(\omega)) dP(\omega) = \int_{\mathbb{R}^2} \Phi(t_1, t_2)h_1(t_1)h_2(t_2) dt_1 dt_2. \quad (*)$$

for every nonnegative Borel function Φ . We shall apply this formula in three situations.

(3a) The first question is whether y_1 and y_2 are independent. For testing independence of y_1 and y_2 , let Φ be the composition $\Phi = I_{A \times B} \circ f$, where $I_{A \times B}$ is the indicator function of the product set. The left side of (*) simplifies to $\mu_{y_1, y_2}(A \times B)$, and we evaluate the right side by making the change of variables $\begin{pmatrix} t_1 \\ t_2 \end{pmatrix} = g \begin{pmatrix} u_1 \\ u_2 \end{pmatrix}$; the tool is Theorem 6.32 of *Basic*. The right side equals

$$\int_{A \times B} h_1(g_1(u_1, u_2))h_2(g_2(u_1, u_2)) \left| \det \left[\frac{\partial t_i}{\partial u_j} \right] \right| du_1 du_2, \quad (**)$$

and the question is whether this expression is a product $v_1(A)v_2(B)$ for Stieltjes measures v_1 and v_2 . Essentially this is the question whether the integrand is the product of a function of u_1 and a function of u_2 . A fairly simple case is that f is a specific linear function from \mathbb{R}^2 to \mathbb{R}^2 , say $f(x_1, x_2) = (x_1 + x_2, x_1 - x_2)$ with inverse $g(y_1, y_2) = (\frac{1}{2}(y_1 + y_2), \frac{1}{2}(y_1 - y_2))$. Then $\det \left[\frac{\partial t_i}{\partial u_j} \right]$ is the constant function $-\frac{1}{2}$, and we are to consider an integrand of the form

$$\frac{1}{2}h_1\left(\frac{1}{2}(u_1 + u_2)\right)h_2\left(\frac{1}{2}(u_1 - u_2)\right).$$

Without some special assumption on h_1 and h_2 , this integrand has little chance of being the product of a function of u_1 by a function of u_2 . Thus y_1 and y_2 will fail to be independent without special additional assumptions.

(3b) The second question is how to deduce from (*) information about the probability distribution of a real-valued function of two variables. Let us take the

function $(x_1, x_2) \mapsto x_1 + x_2$ as an example. The question is to find the probability distribution of $x_1 + x_2$ when x_1 and x_2 are known to be independent. The device is to view $(x_1, x_2) \mapsto x_1 + x_2$ as one coordinate of a change of variables. We can take the other coordinate to be $(x_1, x_2) \mapsto x_2$, so that we are considering the change of variables $\begin{pmatrix} u_1 \\ u_2 \end{pmatrix} = \begin{pmatrix} t_1+t_2 \\ t_2 \end{pmatrix}$ with inverse $\begin{pmatrix} t_1 \\ t_2 \end{pmatrix} = \begin{pmatrix} u_1-u_2 \\ u_2 \end{pmatrix}$. Let Φ be the composition of this function followed by $I_{A \times \mathbb{R}}$. Formulas (*) and (**) give

$$\begin{aligned} \int_{\Omega} I_{A \times \mathbb{R}} \begin{pmatrix} x_1(\omega)+x_2(\omega) \\ x_2(\omega) \end{pmatrix} dP(\omega) &= \int_{\mathbb{R}^2} I_{A \times \mathbb{R}} \begin{pmatrix} t_1+t_2 \\ t_2 \end{pmatrix} h_1(t_1)h_2(t_2) dt_1 dt_2 \\ &= \int_{\mathbb{R}^2} I_{A \times \mathbb{R}}(u_1, u_2)h_1(u_1 - u_2)h_2(u_2) du_1 du_2 \\ &= \int_{\mathbb{R}} I_A(u_1) \left(\int_{\mathbb{R}} h_1(u_1 - u_2)h_2(u_2) du_2 \right) du_1. \end{aligned}$$

The left side is just $\int_A (x_1(\omega) + x_2(\omega)) dP(\omega)$, and thus this equality says that the density of the sum of two random variables x_1 and x_2 is the convolution of the separate densities of x_1 and x_2 .

(3c) The third question is what happens when $(x_1, x_2) \mapsto x_1 + x_2$ in (3b) is replaced by some more general scalar-valued function $(x_1, x_2) \mapsto \varphi(x_1, x_2)$ with φ smooth. Going over what happened in (3b), we see that we can certainly embed this in a smooth change of variables if the partial derivative of φ in the first variable is everywhere positive. The change of variables is then $\begin{pmatrix} u_1 \\ u_2 \end{pmatrix} = \begin{pmatrix} \varphi(t_1, t_2) \\ t_2 \end{pmatrix}$, and the Jacobian determinant is $\frac{\partial \varphi}{\partial t_1} \neq 0$. We can invert by means of either direct computation or the Inverse Function Theorem⁹ and integrate out one variable just as in (3b). We shall use this technique in Section 10.

(4) We now exhibit an assumption that succeeds in yielding independence in Example 3. Suppose that n independent random variables x_1, \dots, x_n are given, and suppose that new random variables y_1, \dots, y_n are formed by a linear function, specifically that

$$\begin{pmatrix} y_1 \\ \vdots \\ y_n \end{pmatrix} = A \begin{pmatrix} x_1 \\ \vdots \\ x_n \end{pmatrix}$$

for an invertible square matrix A . Suppose further that x_1, \dots, x_n have densities given by a quadratic exponential independent of j : $\mu_{x_j} = ce^{-ax_j^2} dx_j$ for all j , where a is positive and c is chosen to make μ_{x_j} have total mass 1. Using the technique of Example 3, let us ask whether y_1, \dots, y_n are independent. In Example 3 we have $h_j(t_j) = ce^{-at_j^2}$ and

$$\mu_{x_1, \dots, x_n} = c^n \prod_j e^{-at_j^2} dt_j = c^n e^{-at \cdot t} dt_1 \cdots dt_n, \quad \text{where } t = (t_1, \dots, t_n).$$

⁹Theorem 3.17 of *Basic*.

We write $u = (u_1, \dots, u_n) = A^{-1}t$ and substitute into (**) of Example 3. The factor $|\det [\frac{\partial t_i}{\partial u_j}]|$ is a positive constant p , and thus

$$\mu_{y_1, \dots, y_n} = c^n p e^{-a(A^{-1}u) \cdot (A^{-1}u)} du_1 \cdots du_n = c^n p e^{-a(A^{-1})^t (A^{-1}u) \cdot u} du_1 \cdots du_n.$$

Because of the transformation property of the exponential function, the coefficient function on the right side is a product of functions of each variable if $(A^{-1})^t (A^{-1})$ is a diagonal matrix. As a result, the transformed random variables are independent if $(A^{-1})^t (A^{-1})$ is a diagonal matrix. An example of a nonsquare matrix with this property is $A = \begin{pmatrix} 1 & 1 \\ -1 & 1 \end{pmatrix}$. We shall make use of this idea in Section 10.

3. Kolmogorov Extension Theorem

The problem addressed by the Kolmogorov theorem is the setting up of a “stochastic process,” a notion that will be defined presently. Many stochastic processes have a time variable in them, which can be discrete or continuous. The process has a set S of “states,” which can be a finite set, a countably infinite set, or a suitably nice uncountable set. It will be sufficient generality for our purposes that the set of states be realizable as a subset of a Euclidean space, the measurable subsets of states being the intersection of S with the Borel sets of the Euclidean space. The defining measurable functions tell the state at each instant of time. Accordingly, one might want to enlarge the definition of random variable to allow the range to contain S . But we shall not do so, instead referring to “measurable functions” in the appropriate places rather than random variables.

Let us give one example of a stochastic process with discrete time and another with continuous time, with particular attention to the passage to the limit that is needed in order to have a probability model realizing the stochastic process.

In the example with discrete time, we shall assume also that the state space S is countable. The probabilistic interpretation of the situation visualizes the process as moving from state to state as time advances through the positive integers, with probabilities depending on the complete past history but not the future; but this interpretation will not be important for us. Let us consider the analysis. In the n^{th} finite approximation $(\Omega_n, \mathcal{A}_n, P_n)$ for $n \geq 1$, the set Ω_n is countable and consists of all ordered n -tuples of members of S , while \mathcal{A}_n is the set of all subsets of Ω_n . The measure P_n is determined by assigning a nonnegative weight to each member of Ω_n , the sum of all the weights being 1. As n varies, a consistency condition is to be satisfied: the sum over S of all the weights in Ω_{n+1} of the $(n+1)$ -tuples that start with a particular n -tuple is the weight in Ω_n attached to that n -tuple. The distinguished measurable functions¹⁰ that tell the

¹⁰The measurable functions are random variables in this case since $S \subseteq \mathbb{R}$.

result of an experiment are the n coordinate functions that associate to an n -tuple ω its various entries. What is wanted is a single measure space (Ω, \mathcal{A}, P) that incorporates all these approximations. It is fairly clear that Ω should be the set of all infinite sequences of members of S and that the distinguished measurable functions are to be the infinite set of coordinate functions. Defining \mathcal{A} and P is a little harder. Each n -tuple $\omega^{(n)}$ forms a singleton set in \mathcal{A}_n , and we associate to $\omega^{(n)}$ the set $T_n(\omega^{(n)})$ of all members of Ω whose initial segment of length n is $\omega^{(n)}$. The members of \mathcal{A}_n are unions of these singleton sets, and we associate to any member X of \mathcal{A}_n the union $T_n(X)$ of the sets $T_n(\omega^{(n)})$ for $\omega^{(n)}$ in X . Also, we define $P(T_n(X)) = P_n(X)$. In this way we identify \mathcal{A}_n with a σ -algebra $T_n(\mathcal{A}_n)$ of subsets of Ω , and we attach a value of P to each member of $T_n(\mathcal{A}_n)$. Define

$$\mathcal{A}' = \bigcup_{n=1}^{\infty} T_n(\mathcal{A}_n).$$

The σ -algebras $T_n(\mathcal{A}_n)$ increase with n , and it follows that the union of two members of \mathcal{A}' is in \mathcal{A}' and that the complement of a member of \mathcal{A}' is in \mathcal{A}' ; hence \mathcal{A}' is an algebra, and \mathcal{A} can be taken as the smallest σ -algebra containing \mathcal{A}' . In the union defining \mathcal{A}' , a set can arise from more than one term. For example, if a set X in \mathcal{A}_n is given and a set Y in \mathcal{A}_{n+1} consists of all $(n+1)$ -tuples whose initial n -tuple lies in X , then $T_n(X) = T_{n+1}(Y)$. The above consistency condition implies that $P_n(X) = P_{n+1}(Y)$, and hence the two definitions of P on the set $T_n(X) = T_{n+1}(Y)$ are consistent. The result is that P is well defined on \mathcal{A}' . Since the $T_n(\mathcal{A}_n)$ increase with n and since the restriction of P to each one is additive, it follows that P is additive. However, it is not apparent whether P is completely additive since the members of a countable disjoint sequence of sets in \mathcal{A}' might not lie in a single $T_n(\mathcal{A}_n)$. This is the matter addressed by the Kolmogorov theorem.

For purposes of being able to have a general theorem, let us make an observation. Although the consistency condition used in the above example appears to rely on the ordering of the time variable, that ordering really plays no role in the above construction. We could as well have defined an F^{th} finite approximation for each finite subset F of the positive integers; the above consistency condition used in passing from $F = \{1, \dots, n\}$ to $F' = \{1, \dots, n, n+1\}$ implies a consistency for general finite sets of indices with $F \subseteq F'$: the result of summing the weights of all members of $\Omega_{F'}$ whose restriction to the coordinates indexed by F is a particular member of Ω_F yields the weight of the member of Ω_F . This observation makes it possible to formulate the Kolmogorov theorem in a way that allows for continuous time.

Let us then come to the example with continuous time. The example is a model of **Brownian motion**, which was discovered as a physical phenomenon in 1826. Microscopic particles, when left alone in a liquid, can be seen to move along

erratic paths; this movement results from collisions between such a particle and molecules of the liquid. An experiment can consist of a record of the position in \mathbb{R}^3 of a particle as a function of time. When the data are studied and suitably extrapolated to the situation that the liquid is all of \mathbb{R}^3 , one finds an explicit formula usable to define the probability that the moving particle lies in given subsets of \mathbb{R}^3 at a given finite set of times. Namely, for $t > 0$, define

$$p^t(x, dy) = \frac{1}{(4\pi t)^{3/2}} e^{-|x-y|^2/(4t)} dy.$$

If $0 = t_0 < t_1 < t_2 \cdots < t_n$, if A_0, \dots, A_n are Borel sets in \mathbb{R}^3 , and if the starting probability distribution of the particle at time 0 is a measure μ on \mathbb{R}^3 , then the probability that the particle is in A_0 at time 0, is in A_1 at time t_1, \dots , is in A_{n-1} at time t_{n-1} , and is in A_n at time t_n is to be taken as

$$\int_{x_0 \in A_0} \int_{x_1 \in A_1} \cdots \int_{x_{n-1} \in A_{n-1}} \int_{x_n \in A_n} p^{\Delta t_n}(x_{n-1}, dx_n) p^{\Delta t_{n-1}}(x_{n-2}, dx_{n-1}) \\ \times \cdots \times p^{\Delta t_1}(x_0, dx_1) d\mu(x_0),$$

where $\Delta t_j = t_j - t_{j-1}$ for $1 \leq j \leq n$. Let F be $\{0, t_1, \dots, t_n\}$. A model describing Brownian motion at the times of F takes Ω_F to be the set of functions from F into \mathbb{R}^3 , i.e., a copy of $(\mathbb{R}^3)^{n+1}$, and the measurable sets are the Borel sets. The distinguished measurable functions are again coordinate functions;¹¹ they pick off the values in \mathbb{R}^3 at each of the times in F . Finally the measure P_F takes the value given by the above formula on the product set $A_0 \times \cdots \times A_n$, and it is evident that P_F extends uniquely to a Borel measure on $\mathbb{R}^{3(n+1)}$, the value of $P_F(A)$ for $A \subseteq \mathbb{R}^{n+1}$ being the integral over A of the integrand in the display above. If F' is the union of F and one additional time, then $P_{F'}$ and P_F satisfy a consistency property saying that if x_j is integrated over all of \mathbb{R}^3 , then the integral can be computed and the result is the same as if index j were completely dropped in the formula; this comes down to the identity

$$\int_{y \in \mathbb{R}^3} \frac{1}{(4\pi s)^{3/2}} \frac{1}{(4\pi t)^{3/2}} e^{-|y-z|^2/(4s)} e^{-|x-y|^2/(4t)} dy = \frac{e^{-|x-z|^2/(4(s+t))}}{(4\pi(s+t))^{3/2}},$$

which follows from the formula $\int_{-\infty}^{\infty} e^{-\pi x^2} dx = 1$, Fubini's Theorem, and some elementary changes of variables. The passage to the limit that needs to be addressed is how to get a model that incorporates all $t \geq 0$ at once. The space can be $(\mathbb{R}^3)^{[0, +\infty)}$. An algebra \mathcal{A}' can be built from the σ -algebras of Borel sets

¹¹Since their values are not in \mathbb{R} , these measurable functions are not, strictly speaking, random variables as we have defined them in Section 1.

of the Euclidean spaces $(\mathbb{R}^3)^F$, and an additive set function P can be consistently defined on \mathcal{A}' so that one recovers P_F on each space $(\mathbb{R}^3)^F$. What needs to be addressed is the complete additivity of P .

A **stochastic process** is nothing more than a family $\{x_i \mid i \in I\}$ of measurable functions defined on a measure space (Ω, \mathcal{A}, P) with $P(\Omega) = 1$. The index set I is assumed nonempty, but no other assumptions are made about it. The measurable functions have values in a more general space S than \mathbb{R} , but we shall assume for simplicity that S is contained in a Euclidean space \mathbb{R}^N and then we may take S equal to \mathbb{R}^N . Although stochastic processes generally are interesting only when the measurable functions are related to each other in some special way, the Kolmogorov theorem does not make use of any such special relationship. It addresses the construction of a general stochastic process out of the approximations to it that are formed from finite subsets of I .

The situation is then as follows. Let I be an arbitrary nonempty index set, let the state space S be \mathbb{R}^N for some fixed integer N , and let $\Omega = S^I$ be the set of functions from I to S . We let x_i , for $i \in I$, be the coordinate function from Ω to S defined by $x_i(\omega) = \omega(i)$. For $J \subseteq I$, we let $x_J = \{x_i \mid i \in J\}$; this is a function carrying Ω to S^J .

For each nonempty finite subset F of I , the image of x_F is the Euclidean space S^F , in which the notion of a Borel set is well defined. A subset A of Ω will be said to be **measurable of type F** if A can be described by

$$A = x_F^{-1}(X) = \{\omega \in \Omega \mid x_F \in X\} \quad \text{for some Borel set } X \subseteq S^F.$$

The collection of subsets of Ω that are measurable of type F is a σ -algebra that we denote by \mathcal{A}_F . If F and F' are finite subsets of I with $F \subseteq F'$ and if the Borel set X of S^F exhibits A as measurable of type F , then the Borel subset $X \times S^{F'-F}$ of $S^{F'}$ exhibits A as measurable of type F' . Consequently $\mathcal{A}_F \subseteq \mathcal{A}_{F'}$.

Let \mathcal{A}' be the union of the \mathcal{A}_F for all finite F . If F and G are finite subsets of I , then we have $\mathcal{A}_F \subseteq \mathcal{A}_{F \cup G}$ and $\mathcal{A}_G \subseteq \mathcal{A}_{F \cup G}$, and it follows that \mathcal{A}' is closed under finite unions and complements. Hence \mathcal{A}' is an algebra of subsets of Ω .

In effect the Kolmogorov theorem will assume that we have a consistent system of stochastic processes for all finite subsets of I . In other words, for each finite subset F of I , we assume that we have a measure space $(S^F, \mathcal{B}_F, P_F)$ with \mathcal{B}_F as the Borel sets of the Euclidean space S^F , with $P_F(S^F) = 1$, and with the distinguished measurable functions taken as the x_i for i in F . The measures P_F are to satisfy a consistency condition as follows. To each X in \mathcal{B}_F , we define a subset A_X of Ω by $A_X = x_F^{-1}(X)$; this subset of Ω is measurable of type F , and we transfer the measure from \mathcal{B}_F to \mathcal{A}_F by defining $P_F(A_X) = P_F(X)$. The consistency condition is that there is a well-defined nonnegative additive set function P on \mathcal{A}' whose restriction to each \mathcal{A}_F is P_F . The content of the theorem is that we obtain a stochastic process for I itself.

Theorem 9.5 (Kolmogorov Extension Theorem). Let I be a nonempty index set, let $S = \mathbb{R}^N$, and let $\Omega = S^I$ be the set of functions from I to S . For each nonempty finite subset F of I , let \mathcal{A}_F be the σ -algebra of subsets of Ω that are measurable of type F , and let \mathcal{A}' be the algebra of sets given by the union of the \mathcal{A}_F for all finite F . If P is a nonnegative additive set function defined on \mathcal{A}' such that $P(\Omega) = 1$ and $P|_{\mathcal{A}_F}$ is completely additive for every finite F , then P is completely additive on \mathcal{A}' and therefore extends to a measure on the smallest σ -algebra containing \mathcal{A}' .

PROOF. Once we have proved that P is completely additive on \mathcal{A}' , P extends to a measure on the smallest σ -algebra containing \mathcal{A}' as a consequence of the Extension Theorem.¹² Let A_n be a decreasing sequence of sets in \mathcal{A}' with $P(A_n) \geq \epsilon > 0$ for some positive ϵ . It is enough to prove that $\bigcap_{n=1}^{\infty} A_n$ is not empty.

Each member of \mathcal{A}' is measurable of type F for some finite F , and we suppose that A_n is measurable of type F_n . There is no loss of generality in assuming that $F_1 \subseteq F_2 \subseteq \dots$ since a set that is measurable of type F is measurable of type F' for any F' containing F . Let x_i , for $i \in I$, be the i^{th} coordinate function on Ω , and let $x_F = \{x_i \mid i \in F\}$ for each finite subset F of I . Just as in the definition of joint probability distribution, we define a Borel measure μ_F on the Euclidean space S^F by $\mu_F(X) = P(x_F^{-1}(X))$. This is a measure since $P|_{\mathcal{A}_F}$ is assumed to be completely additive.

By definition of “measurable of type F ,” the set A_n is of the form

$$A_n = \{\omega \in \Omega \mid x_{F_n}(\omega) \in X_n\}$$

for some Borel subset X_n of the Euclidean space S^{F_n} . Since $P(A_n) \geq \epsilon$, the definition of μ_{F_n} makes $\mu_{F_n}(X_n) \geq \epsilon$. Since S^{F_n} is a Euclidean space, the measure μ_{F_n} is regular. Therefore there exists a compact subset K_n of X_n with $\mu_{F_n}(X_n - K_n) \leq 3^{-n}\epsilon$. Putting

$$B_n = \{\omega \in \Omega \mid x_{F_n}(\omega) \in K_n\},$$

we see that $P(A_n - B_n) \leq 3^{-n}\epsilon$. Let

$$C_n = \bigcap_{j=1}^n B_j.$$

Each C_n is a subset of A_n , and the sets C_n are decreasing. We shall prove that

$$P(C_n) \geq \epsilon/2. \quad (*)$$

¹²Theorem 5.5 of *Basic*.

The proof of (*) will involve an induction: we show inductively for each k that $B_k = D_k \cup C_k$ with $P(D_k) \leq \sum_{j=1}^{k-1} 3^{-j}\epsilon$ and $P(C_k) \geq (1 - \sum_{j=1}^k 3^{-j})\epsilon$. Since

$$1 - \sum_{j=1}^k 3^{-j} \geq 1 - \sum_{j=1}^{\infty} 3^{-j} = 1 - \frac{1/3}{1-1/3} = \frac{1}{2},$$

this induction will prove (*).

The base case of the induction is $k = 1$. In this case we have $C_1 = B_1$. If we take $D_1 = \emptyset$, then we have $B_1 = D_1 \cup C_1$ and $P(D_1) \leq 0$ trivially, and we have $P(C_1) \geq (1 - \frac{1}{3})\epsilon$ by construction of B_1 . The inductive hypothesis is that

$B_k = D_k \cup C_k$ with $P(D_k) \leq \sum_{j=1}^{k-1} 3^{-j}\epsilon$ and $P(C_k) \geq (1 - \sum_{j=1}^k 3^{-j})\epsilon$. We know

that $A_k = (A_k - B_k) \cup B_k$. Since $B_{k+1} \subseteq A_{k+1} \subseteq A_k$, we can intersect B_{k+1} with this equation and then use the inductive hypothesis to obtain

$$\begin{aligned} B_{k+1} &= (B_{k+1} \cap (A_k - B_k)) \cup (B_{k+1} \cap B_k) \\ &= (B_{k+1} \cap (A_k - B_k)) \cup (B_{k+1} \cap (D_k \cup C_k)) \\ &= (B_{k+1} \cap (A_k - B_k)) \cup (B_{k+1} \cap D_k) \cup C_{k+1}. \end{aligned}$$

If we put $D_{k+1} = (B_{k+1} \cap (A_k - B_k)) \cup (B_{k+1} \cap D_k)$, then $B_{k+1} = D_{k+1} \cup C_{k+1}$ and

$$P(D_{k+1}) \leq P(A_k - B_k) + P(D_k) \leq 3^{-k}\epsilon + \sum_{j=1}^{k-1} 3^{-j}\epsilon = \sum_{j=1}^k 3^{-j}\epsilon.$$

The identity $A_{k+1} = (A_{k+1} - B_{k+1}) \cup B_{k+1}$ and the inequalities $P(A_{k+1}) \geq \epsilon$ and $P(A_{k+1} - B_{k+1}) \leq 3^{-k-1}\epsilon$ together imply that $P(B_{k+1}) \geq (1 - 3^{-k-1})\epsilon$.

From $B_{k+1} = D_{k+1} \cup C_{k+1}$ and $P(D_{k+1}) \leq \sum_{j=1}^k 3^{-j}\epsilon$, we therefore conclude

that $P(C_{k+1}) \geq (1 - \sum_{j=1}^{k+1} 3^{-j})\epsilon$. This completes the induction, and (*) is thereby proved.

The set C_n is in \mathcal{A}_{F_n} since $F_1 \subseteq F_2 \subseteq \dots \subseteq F_n$, and thus C_n is given by

$$C_n = \{\omega \in \Omega \mid x_{F_n}(\omega) \in L_n\}$$

for some Borel subset L_n of K_n in S^{F_n} . For $1 \leq j \leq n$, we have

$$B_j = \{\omega \in \Omega \mid x_{F_n}(\omega) \in K_j \times S^{F_n - F_j}\},$$

and the set $K_j \times S^{F_n - F_j}$ is closed in S^{F_n} for $j < n$ and compact for $j = n$. Thus $L_n = \bigcap_{j=1}^n (K_j \times S^{F_n - F_j})$ is a compact subset of S^{F_n} .

If $F \subseteq F'$, let us identify $S^{F'}$ with the subset $S^{F'} \times \{0\}$ of $\Omega = S^I$, so that it is meaningful to apply x_F to $S^{F'}$. Then we have $x_F x_{F'} = x_F$, and $x_{F_n}(L_p)$ makes sense for $p \geq n$.

If $p \geq q$, then we have $x_{F_p}^{-1}(L_p) = C_p \subseteq C_q = x_{F_q}^{-1}(L_q) = x_{F_p}^{-1}(L_q \times S^{F_p - F_q})$, and hence $L_p \subseteq L_q \times S^{F_p - F_q}$. Application of x_{F_q} gives $x_{F_q}(L_p) \subseteq L_q$. If $p \geq q \geq n$, then the further application of x_{F_n} gives $x_{F_n}(L_p) \subseteq x_{F_n}(L_q) \subseteq L_n$. Thus the sets $x_{F_n}(L_p)$, as p varies for $p \geq n$, form a decreasing sequence of compact sets in S^{F_n} . Since $P(C_p) \geq \epsilon/2$ by (*), C_p is not empty; thus L_p is not empty and $x_{F_n}(L_p)$ is not empty. Since L_n is a compact metric space,

$$M_n = \bigcap_{p=n}^{\infty} x_{F_n}(L_p)$$

is not empty.

Let us prove that

$$x_{F_n}(M_{n+1}) = M_n. \quad (**)$$

For $p \geq n+1$, we have $x_{F_n}(M_{n+1}) \subseteq x_{F_n}(x_{F_{n+1}}(L_p)) = x_{F_n}(L_p)$. Intersecting the right side over p gives $x_{F_n}(M_{n+1}) \subseteq M_n$. For the reverse inclusion, let m be in M_n . Then $m = x_{F_n}(\ell_p)$ with $\ell_p \in L_p$ for $p \geq n+1$. For the same ℓ_p 's, define $m'_p = x_{F_{n+1}}(\ell_p)$. Then $x_{F_n}(m'_p) = x_{F_n}(x_{F_{n+1}}(\ell_p)) = x_{F_n}(\ell_p) = m$. The element m'_p is in $x_{F_{n+1}}(L_p)$ and hence in $\bigcap_{q=n+1}^p x_{F_{n+1}}(L_q)$. The elements m'_p all lie in the compact set L_{p+1} , and hence they have a convergent subsequence $\{m'_{p_k}\}$. The limit m' of this subsequence is in $\bigcap_{q=n+1}^{p_k} x_{F_{n+1}}(L_q)$ for all k , and thus m' is in M_{n+1} . Since $x_{F_n}(m'_p) = m$, we have $x_{F_n}(m') = x_{F_n}(\lim_k m'_{p_k}) = \lim_k x_{F_n}(m'_{p_k}) = m$. In other words, m lies in $x_{F_n}(M_{n+1})$. This proves (**).

Using (**), we shall define disjoint coordinate blocks of an element ω in Ω . Pick some m_1 in M_1 , use (*) to find some m_2 in M_2 with $m_1 = x_{F_1}(m_2)$, use (*) to find some m_3 in M_3 with $m_2 = x_{F_2}(m_3)$, and so on. Define ω so that $x_{F_1}(\omega) = m_1$ and $x_{F_n - F_{n-1}}(\omega) = m_n - m_{n-1}$ for $n \geq 2$. Define ω to be 0 in all coordinates indexed by $I - \bigcup_{n=1}^{\infty} F_n$. Then we have

$$x_{F_n}(\omega) = x_{F_1}(\omega) + \sum_{k=2}^n x_{F_k - F_{k-1}}(\omega) = m_1 + \sum_{k=2}^n (m_k - m_{k-1}) = m_n.$$

Thus $x_{F_n}(\omega)$ is exhibited as in $M_n \subseteq L_n$ for all n . Hence ω is in $\bigcap_{n=1}^{\infty} C_n$, and we have succeeded in proving that $\bigcap_{n=1}^{\infty} C_n$ is not empty. \square

Corollary 9.6. Let I be a nonempty index set, and for each i in I let μ_i be a Borel measure on \mathbb{R} with $\mu_i(\mathbb{R}) = 1$. Then there exists a probability space with independent random variables x_i for i in I such that x_i has probability distribution μ_i .

PROOF. In Theorem 9.5 let $S = \mathbb{R}$, and for each finite subset F of I , define $P|_{\mathcal{A}_F}$ to be the product measure $\prod_{i \in F} \mu_i$ on the Euclidean space \mathbb{R}^F . The theorem makes R^I into a probability space by exhibiting the consistent extension P of all the $P|_{\mathcal{A}_F}$'s as completely additive. Then the coordinate functions x_i are the required independent random variables. \square

4. Strong Law of Large Numbers

Traditional laws of large numbers concern a sequence $\{x_n\}$ of identically distributed independent random variables, and we shall assume that their common mean μ exists. Define $s_n = x_1 + \cdots + x_n$ for $n \geq 1$. The conclusion is that the quantities $\frac{1}{n} s_n$ converge in some sense to μ , i.e., that the x_n are Cesàro summable to the constant μ . The simplest versions of the law of large numbers assume also that the common “variance” is finite. Let us back up a moment and define this notion.

The **variance** of a random variable x with mean $E(x) = \mu$ is the quantity

$$\text{Var}(x) = E((x - \mu)^2) = E(x^2) - \mu^2,$$

the right-hand equality holding since

$$E((x - \mu)^2) = E(x^2) - 2\mu E(x) + \mu^2 E(1) = E(x^2) - \mu^2.$$

For any random variables the means add since mean is linear. For two *independent* random variables x and y , the variances add since we can apply Proposition 9.3, compute the quantities

$$E((x + y)^2) = E(x^2) + 2E(xy) + E(y^2) = E(x^2) + 2E(x)E(y) + E(y^2)$$

$$\text{and } (E(x) + E(y))^2 = E(x)^2 + 2E(x)E(y) + E(y)^2,$$

and subtract to obtain

$$\text{Var}(x + y) = (E(x^2) - E(x)^2) + (E(y^2) - E(y)^2) = \text{Var}(x) + \text{Var}(y).$$

For a constant multiple c of a random variable x , we have

$$E(cx) = cE(x) \quad \text{and} \quad \text{Var}(cx) = c^2 \text{Var}(x).$$

Returning to our sequence $\{x_n\}$ of identically distributed independent random variables, we therefore have $E(s_n) = E(x_1) + \cdots + E(x_n) = n\mu$ and $\text{Var}(s_n) = \text{Var}(x_1) + \cdots + \text{Var}(x_n) = n\sigma^2$, where σ^2 denotes the common variance of the given random variables x_k . Consequently

$$E\left(\frac{1}{n} s_n\right) = \mu \quad \text{and} \quad \text{Var}\left(\frac{1}{n} s_n\right) = \frac{1}{n} \sigma^2.$$

If we take our probability space to be (Ω, P) and apply Chebyshev’s inequality to the variance¹³ of $\frac{1}{n} s_n$, we obtain

$$\frac{1}{n} \sigma^2 = \int_{\Omega} \left(\frac{1}{n} s_n - \mu\right)^2 dP \geq \xi^2 P\left(\left\{\left|\frac{1}{n} s_n - \mu\right| \geq \xi\right\}\right).$$

Holding ξ fixed and letting n tend to infinity, we obtain the first form historically of the law of large numbers, as follows.

¹³Chebyshev’s inequality appears in Section VI.10 of *Basic* and is the elementary inequality $\int_X |f|^2 d\mu \geq \xi^2 \mu(\{x \mid |f(x)| \geq \xi\})$ valid on any measure space for any measurable f and any real $\xi > 0$.

Theorem 9.7 (Weak Law of Large Numbers). Let $\{x_n\}$ be a sequence of identically distributed independent random variables with a common mean μ and a common finite variance. Define $s_n = x_1 + \cdots + x_n$. Then for every real $\xi > 0$,

$$\lim_{n \rightarrow \infty} P\left(\left|\frac{1}{n} s_n - \mu\right| \geq \xi\right) = 0.$$

REMARKS. In terminology that will be defined in Section 5, the statement in words is that $\frac{1}{n} s_n$ “converges to μ in probability.” With more effort one can obtain the conclusion of the Weak Law of Large Numbers without the hypothesis of finite variance. Instead of making that direct extra effort, however, we shall deduce in Section 5 the Weak Law of Large Numbers from the Strong Law of Large Numbers below, and there will be no need to assume finite variance.

As a practical matter, the fact that $P\left(\left|\frac{1}{n} s_n - \mu\right| \geq \xi\right)$ tends to 0 is of comparatively little interest. Of more interest is a probability estimate for the event that $\lim \frac{1}{n} s_n = \mu$. This is contained in the following theorem, whose proof will occupy the remainder of this section.

Theorem 9.8 (Strong Law of Large Numbers). Let $\{x_n\}$ be a sequence of identically distributed independent random variables whose common mean μ exists. Define $s_n = x_1 + \cdots + x_n$. Then

$$\lim_{n \rightarrow \infty} \frac{1}{n} s_n = \mu \quad \text{with probability 1.}$$

Many members of the public have heard of this theorem in some form. Misconceptions abound, however. The usual misconception is that if the average $\frac{1}{n} s_n(\omega)$ has gotten to be considerably larger than μ by some point n in time, then the chances become overwhelming that the average will have corrected itself fairly soon thereafter. Independence says otherwise: that the future values of the x_k 's are not influenced by what has happened through time n . In fact, if a person is persuaded that it was unreasonable for the average $\frac{1}{n} s_n(\omega)$ to have gotten considerably larger than μ by some time n , then the person might better instead question whether the mean μ is known correctly or even whether the individual x_n 's are genuinely independent. If μ has been greatly underestimated, for example, not only was it reasonable for the average $\frac{1}{n} s_n(\omega)$ to have gotten considerably larger than μ , but it is reasonable for it to continue to do so.

The proof of Theorem 9.8 will be preceded by three lemmas.

Lemma 9.9 (Borel–Cantelli Lemma). Let $\{A_k\}$ be a sequence of events in a probability space (Ω, P) such that $\sum_{k=1}^{\infty} P(A_k) < \infty$. Then $P\left(\bigcap_{n=1}^{\infty} \bigcup_{k \geq n} A_k\right) = 0$. Hence the probability that infinitely many of the events A_k occur is 0.

PROOF. Since $\sum_{k=1}^{\infty} P(A_k)$ is convergent, we have $\limsup_n \sum_{k=n}^{\infty} P(A_k) = 0$. For every n , we have $P(\bigcap_{n=1}^{\infty} \bigcup_{k \geq n} A_k) \leq P(\bigcup_{k \geq n} A_k) \leq \sum_{k=n}^{\infty} P(A_k)$. The left side of the inequality is independent of n , and therefore $P(\bigcap_{n=1}^{\infty} \bigcup_{k \geq n} A_k) \leq \limsup_n \sum_{k=n}^{\infty} P(A_k) = 0$. This proves the first conclusion. Since $\bigcap_{n=1}^{\infty} \bigcup_{k \geq n} A_k$ is the set of ω that lie in infinitely many of the sets A_k , the second conclusion follows. \square

Lemma 9.10. Let x be a random variable on a probability space (Ω, P) . Then $\sum_{k=1}^{\infty} P(\{|x| > k\}) < \infty$ if and only if the mean of $|x|$ exists.

PROOF. Proposition 6.56b of *Basic* gives

$$\int_{\Omega} |x| dP = \int_0^{\infty} P(\{|x(\omega)| > \xi\}) d\xi.$$

The lemma therefore follows from the inequalities

$$\begin{aligned} \sum_{k=1}^{\infty} P(\{|x| > k\}) &= \sum_{k=0}^{\infty} P(\{|x| > k + 1\}) \leq \sum_{k=0}^{\infty} \int_k^{k+1} P(\{|x| > \xi\}) d\xi \\ &= \int_0^{\infty} P(\{|x| > \xi\}) d\xi \leq \sum_{k=0}^{\infty} P(\{|x| > k\}). \end{aligned} \quad \square$$

Lemma 9.11 (Kolmogorov’s inequality). Let x_1, \dots, x_n be independent random variables on a probability space (Ω, P) , and suppose that $E(x_k) = 0$ and $E(x_k^2) < \infty$ for all k . Put $s_k = x_1 + \dots + x_k$. Then

$$P(\{\omega \mid \max(|s_1|, \dots, |s_n|) > c\}) \leq c^{-2} E(s_n^2)$$

for every real $c > 0$.

REMARKS. It is not necessary to assume that $E(x_1) = 0$. For $n = 1$, the lemma consequently reduces to Chebyshev’s inequality.

PROOF. Let A_j be the event that j is the smallest index for which $|s_j| > c$. The sets A_j are disjoint, and their union is the set whose probability occurs on the left side of the displayed inequality. Combining this fact with Chebyshev’s inequality gives

$$P(\{\omega \mid \max(|s_1|, \dots, |s_n|) > c\}) = \sum_{j=1}^n P(A_j) \leq c^{-2} \sum_{j=1}^n E(s_j^2 I_{A_j}), \quad (*)$$

where I_{A_j} is the indicator function of A_j . Since $s_n = s_j + (s_n - s_j)$,

$$\begin{aligned} E(s_n^2 I_{A_j}) &= E(s_j^2 I_{A_j}) + 2E((s_n - s_j)s_j I_{A_j}) + E((s_n - s_j)^2 I_{A_j}) \\ &\geq E(s_j^2 I_{A_j}) + 2E((s_n - s_j)s_j I_{A_j}). \end{aligned}$$

The random variables $s_n - s_j$ and $s_j I_{A_j}$ are independent by Proposition 9.4, and their product has mean 0 by Proposition 9.3 since $E(s_n - s_j) = \sum_{i=j+1}^n E(x_i) = 0$.

Therefore $E(s_n^2 I_{A_j}) \geq E(s_j^2 I_{A_j})$, and (*) gives

$$\begin{aligned} P(\{\omega \mid \max(|s_1|, \dots, |s_n|) > c\}) &\leq c^{-2} \sum_{j=1}^n E(s_j^2 I_{A_j}) \leq c^{-2} \sum_{j=1}^n E(s_n^2 I_{A_j}) \\ &= c^{-2} E(s_n^2 I_{\cup_j A_j}) \leq c^{-2} E(s_n)^2. \quad \square \end{aligned}$$

PROOF OF THEOREM 9.8. Let the underlying probability space be denoted by (Ω, P) . Subtraction of the constant μ from each of the random variables x_k does not affect the independence, according to Proposition 9.4, and it reduces the proof to the case that $\mu = 0$. Therefore we may proceed under the assumption that $\mu = 0$. For integers $k \geq 1$, define

$$\begin{aligned} x'_k &= \begin{cases} x_k & \text{where } |x_k| \leq k, \\ 0 & \text{where } |x_k| > k, \end{cases} \\ \text{and} \quad x''_k &= \begin{cases} 0 & \text{where } |x_k| \leq k, \\ x_k & \text{where } |x_k| > k, \end{cases} \end{aligned}$$

so that $x_k = x'_k + x''_k$. Define $s'_n = x'_1 + \dots + x'_n$ and $s''_n = x''_1 + \dots + x''_n$. It is enough to show that $\frac{1}{n} s'_n$ and $\frac{1}{n} s''_n$ both tend to 0 with probability 1.

First we show that $\frac{1}{n} s''_n$ tends to 0 with probability 1. Let x be a random variable with the same probability distribution as the x_k 's. Referring to the definition of x''_k , we see that $P(\{|x| > k\}) = P(\{|x_k| > k\}) = P(\{x''_k \neq 0\})$. Since $E(|x|)$ exists by assumption, Lemma 9.10 shows that $\sum_{k=1}^{\infty} P(\{|x| > k\}) < \infty$.

Therefore $\sum_{k=1}^{\infty} P(\{x''_k \neq 0\}) < \infty$. By the Borel–Cantelli Lemma (Lemma 9.10), the probability that ω lies in infinitely many of the sets $\{x''_k \neq 0\}$ is 0. Thus by disregarding ω 's in a set of probability 0, we may assume $x''_k(\omega) \neq 0$ for only finitely many k . Then $s''_n(\omega)$ remains constant as a function of n for large n , and we must have $\lim_n \frac{1}{n} s''_n(\omega) = 0$.

Now we consider $\frac{1}{n} s'_n$. The random variables x'_k are independent, but they are no longer identically distributed and they no longer need have mean 0. However, they satisfy inequalities of the form $|x'_k| \leq k$, and these in turn imply that each $E(x_k'^2)$ is finite. Concerning the means, let x be a random variable with the same probability distribution as any of the x_k 's. The random variable $x_k^\#$ equal to x where $|x| \leq k$ and equal to 0 otherwise has $|x_k^\#| \leq |x|$ for all k , and hence

dominated convergence yields $\lim_k E(x_k^\#) = E(x) = 0$. Since x'_k and $x_k^\#$ have the same probability distribution, we have $\lim_k E(x'_k) = 0$. The expression $E(\frac{1}{n}s'_n)$ is a Cesàro sum of the sequence $\{E(x'_k)\}$. Since the Cesàro sums tend to 0 when the sequence itself tends to 0, we conclude that

$$\lim_n E(\frac{1}{n}s'_n) = 0. \quad (*)$$

Let μ be the common probability distribution of the $|x_k|$'s. The next step is to show that

$$\sum_{r=1}^{\infty} 2^{-2r} \sum_{k=2^{r-1}}^{2^r-1} E(x_k'^2) \leq 2 \int_0^{\infty} t d\mu(t). \quad (**)$$

The quantity on the right is twice the common value of $E(|x_k|)$ and is finite since we have assumed that the common mean of the x_k 's exists. Once we have proved (**), we can therefore conclude that the quantity on the left side is finite. To prove (**), we write

$$\begin{aligned} \sum_{r=1}^{\infty} 2^{-2r} \sum_{k=2^{r-1}}^{2^r-1} E(x_k'^2) &= \sum_{r=1}^{\infty} 2^{-2r} \sum_{k=2^{r-1}}^{2^r-1} \int_0^k t^2 d\mu(t) \\ &\leq \sum_{r=1}^{\infty} 2^{-r} \int_0^{2^r} t^2 d\mu(t) \\ &\leq \int_0^1 t^2 d\mu(t) + \sum_{r=1}^{\infty} 2^{-r} \int_1^{2^r} t^2 d\mu(t). \end{aligned}$$

Let us write I and II for the two terms on the right side. The estimate for II is

$$\begin{aligned} \text{II} &= \sum_{r=1}^{\infty} 2^{-r} \sum_{j=1}^r \int_{2^{j-1}}^{2^j} t^2 d\mu(t) \leq \sum_{r=1}^{\infty} \sum_{j=1}^r 2^{-r} 2^j \int_{2^{j-1}}^{2^j} t d\mu(t) \\ &= \sum_{j=1}^{\infty} \sum_{r=j}^{\infty} 2^{-r} 2^j \int_{2^{j-1}}^{2^j} t d\mu(t) = 2 \sum_{j=1}^{\infty} \int_{2^{j-1}}^{2^j} t d\mu(t) = 2 \int_1^{\infty} t d\mu(t). \end{aligned}$$

Therefore

$$\begin{aligned} \text{I} + \text{II} &\leq \int_0^1 t^2 d\mu(t) + 2 \int_1^{\infty} t d\mu(t) \\ &\leq 2 \int_0^1 t d\mu(t) + 2 \int_1^{\infty} t d\mu(t) = 2 \int_0^{\infty} t d\mu(t), \end{aligned}$$

and (**) is proved.

Form the sequence of random variables $x_k^* = x'_k - E(x'_k)$, and put $s_n^* = x_1^* + \cdots + x_n^*$. The x_k^* are independent but no longer identically distributed. They have mean 0. Since

$$E(x_k^{*2}) = E((x'_k - E(x'_k))^2) = E(x_k'^2) - E(x_k')^2 \leq E(x_k'^2),$$

(**) shows that the x_k^* have the property that $\sum_{r=1}^{\infty} 2^{-2r} \sum_{k=2^{r-1}}^{2^r-1} E(x_k^{*2}) < \infty$. To prove the theorem, it would be enough to prove that the Cesàro sums $\frac{1}{n} s_n^* = \frac{1}{n} s'_n - E(\frac{1}{n} s'_n)$ tend to 0, since we know from (*) that $\lim_n E(\frac{1}{n} s'_n) = 0$.

Changing notation, we see that we have reduced matters to proving the following: if $\{x_k\}$ is a sequence of independent random variables with mean 0 and with

$$\sum_{r=1}^{\infty} 2^{-2r} \sum_{k=2^{r-1}}^{2^r-1} E(x_k^2) < \infty, \quad (\dagger)$$

and if s_n denotes $x_1 + \dots + x_n$, then $\lim_n \frac{1}{n} s_n = 0$ with probability 1.

To prove this assertion, we apply Kolmogorov's inequality (Lemma 9.11) for each $r \geq 0$ to the 2^{r-1} random variables $x_{2^{r-1}}, x_{2^{r-1}+1}, \dots, x_{2^r-1}$. These are independent with mean 0, and $E(x_k^2)$ is finite for each by (\dagger). Their partial sums are

$$s_{2^r-1} - s_{2^{r-1}-1}, \dots, s_{2^r-1} - s_{2^{r-1}-1},$$

and the last partial sum has $E((s_{2^r-1} - s_{2^{r-1}-1})^2) = \sum_{k=2^{r-1}}^{2^r-1} E(x_k^2)$ by Proposition 9.3. Kolmogorov's inequality therefore gives, for any fixed $\varepsilon > 0$,

$$P(\{\max(|s_{2^r-1} - s_{2^{r-1}-1}|, \dots, |s_{2^r-1} - s_{2^{r-1}-1}|) > 2^r \varepsilon\}) \leq \varepsilon^{-2} 2^{-2r} \sum_{k=2^{r-1}}^{2^r-1} E(x_k^2).$$

Summing on r and applying (\dagger), we see that

$$\sum_{r=1}^{\infty} P(\{\max(2^{-r} |s_{2^r-1} - s_{2^{r-1}-1}|, \dots, 2^{-r} |s_{2^r-1} - s_{2^{r-1}-1}|) > \varepsilon\}) < \infty.$$

The Borel–Cantelli Lemma (Lemma 9.9) shows that with probability 1, there are only finitely many r 's for which

$$\max(2^{-r} |s_{2^r-1} - s_{2^{r-1}-1}|, \dots, 2^{-r} |s_{2^r-1} - s_{2^{r-1}-1}|) > \varepsilon.$$

Fix any ω that is not in the exceptional set A_ε of probability 0, and choose $r_0 = r_0(\omega)$ such that

$$\max(2^{-r} |s_{2^r-1}(\omega) - s_{2^{r-1}-1}(\omega)|, \dots, 2^{-r} |s_{2^r-1}(\omega) - s_{2^{r-1}-1}(\omega)|) \leq \varepsilon$$

for all $r \geq r_0$. If $n > 2^{r_0}$ is given, find r such that $2^{r-1} \leq n \leq 2^r - 1$. Then we have

$$\begin{aligned} 2^{-r} |s_n(\omega) - s_{2^{r-1}-1}(\omega)| &\leq \varepsilon, \\ 2^{-(r-1)} |s_{2^{r-1}-1}(\omega) - s_{2^{r-2}-1}(\omega)| &\leq \varepsilon, \\ &\vdots \\ 2^{-r_0} |s_{2^{r_0}-1}(\omega) - s_{2^{r_0-1}-1}(\omega)| &\leq \varepsilon. \end{aligned}$$

Multiplying the k^{th} inequality by 2^{-k+2} , summing for $k \geq 1$, and applying the triangle inequality, we obtain

$$n^{-1}|s_n(\omega) - s_{2^{r_0-1}}(\omega)| \leq 2^{-r+1}|s_n(\omega) - s_{2^{r_0-1}}(\omega)| \leq 4\varepsilon.$$

Therefore $n^{-1}|s_n(\omega)| \leq 4\varepsilon + n^{-1}|s_{2^{r_0-1}}(\omega)|$.

Hence $\limsup_n \frac{1}{n} |s_n(\omega)| \leq 4\varepsilon$.

If ω is not in the union $\bigcup_{m=1}^{\infty} A_{1/m}$ of the exceptional sets, then $\limsup_n \frac{1}{n} |s_n(\omega)| = 0$. This countable union of exceptional sets of probability 0 has probability 0, and the proof is therefore complete. \square

5. Convergence in Distribution

The two laws of large numbers concern convergence of a sequence of random variables in two different fashions, and in this section we shall be a little more systematic about different kinds of convergence.

Let $\{x_n\}$ be a sequence of random variables on a probability space (Ω, P) , and let x be another random variable on that space. One says that $\{x_n\}$ **converges almost surely** to x if $\lim_n x_n(\omega) = x(\omega)$ pointwise except possibly on a set of P measure 0. This is the notion of convergence in the Strong Law of Large Numbers (Theorem 9.8). It is same notion as almost everywhere convergence, but probabilists use a term for it that conveys something in probabilistic terms. Another expression that is used for the same notion is that $\{x_n\}$ **converges to x with probability 1**. Notation that is often used for this notion, but which we shall not use, is

$$\{x_n\} \xrightarrow{\text{a.s.}} x.$$

A second notion is that $\{x_n\}$ **converges in probability** to x if for each real number $\xi > 0$, $\lim_n P(\{\omega \mid |x_n(\omega) - x(\omega)| \geq \xi\}) = 0$. Some authors write

$$\{x_n\} \xrightarrow{\mathcal{P}} x.$$

This is the notion of convergence in the Weak Law of Large Numbers (Theorem 9.7). We mentioned in Section 4 that the strong law implies the weak law and that the assumption of finite variance is unnecessary in the weak law. This fact is a special case of the following result.

Proposition 9.12. If a sequence $\{x_n\}$ of random variables on a probability space (Ω, P) converges to a random variable x almost surely, then it converges to x in probability.

PROOF. Let Z be the measure-zero subset of Ω on which pointwise convergence of $\{x_n(\omega)\}$ to $x(\omega)$ fails. Redefining x and all x_n to be 0 on Z , we affect neither the hypothesis nor the conclusion, but we now have convergence at every point. Let $\xi > 0$ be given, and define

$$E_N = \{\omega \in \Omega \mid |x_n(\omega) - x(\omega)| < \xi \text{ for all } n \geq N\}.$$

Then $\{E_N\}$ is an increasing sequence of sets, and the pointwise convergence of $\{x_n\}$ to x implies that $\bigcup_N E_N = \Omega$. By the complete additivity of P , $\lim_N P(E_N) = P(\Omega) = 1$. Consequently

$$\lim_N P\{\omega \in \Omega \mid |x_n(\omega) - x(\omega)| \geq \xi \text{ for some } n \geq N\} = 0,$$

and it follows that

$$\lim_N P\{\omega \in \Omega \mid |x_N(\omega) - x(\omega)| \geq \xi\} = 0. \quad \square$$

EXAMPLE. The expected converse statement is false. That is, it is possible for a sequence $\{x_n\}$ of random variables to converge to 0 in probability without converging to 0 almost surely. Take the probability space to be $[0, 1]$ with Lebesgue measure m , and let x_n be the indicator function of a set E_n to be specified. Then $\{x_n\}$ converges to 0 in probability if (and only if) $\lim_n m(E_n) = 0$, but it does not converge to 0 almost surely if there is a set of points ω of positive Lebesgue measure such that ω is in infinitely many of the sets E_n . To define such sets E_n , take a divergent infinite series $\sum a_n$ whose terms are positive and tend to 0, such as with $a_n = 1/n$. Let E_n be the interval extending from $\sum_{k=1}^{n-1} a_k$ to $\sum_{k=1}^n a_k$ but taken modulo 1. Then the sets E_n have the required properties.

There is a third kind of convergence that will interest us, and this is the kind that will occur in the Central Limit Theorem in Section 9. Let $\{x_n\}$ be a sequence of random variables, and let x be another random variable. Let F_n be the cumulative distribution function of x_n , and let F be the cumulative distribution function of x . One says that $\{x_n\}$ **converges to x in distribution** if $\lim_n F_n(t) = F(t)$ at every point of continuity of F . The term **converges in law** is also used, and some authors write

$$\{x_n\} \xrightarrow{\mathcal{L}} x.$$

A little surprisingly this kind of convergence is even weaker than convergence in probability. In fact, convergence in distribution depends only on the cumulative distribution functions in question. If, for example, we have any sequence

of random variables with a common distribution function, then that sequence converges in distribution. Such random variables do not even need to be defined on the same space.

To have convergence in probability, we need the the differences $|x_n(\omega) - x(\omega)|$ that appear in the definition of convergence in probability to be defined; thus x and the x_n need to be defined on the same space. So convergence in distribution does not imply convergence in probability.

Proposition 9.13. Convergence of a sequence $\{x_n\}$ of random variables in probability to a random variable x implies convergence of $\{x_n\}$ to x in distribution.

PROOF. Fix a point t where F is continuous, and fix a number $\epsilon > 0$. Since $x(\omega) > t + \epsilon$ and $|x_n(\omega) - x(\omega)| \leq \epsilon$ together imply that $x_n > t$, we have

$$\{\omega \mid x_n(\omega) \leq t\} \subseteq \{\omega \mid x(\omega) \leq t + \epsilon\} \cup \{\omega \mid |x_n(\omega) - x(\omega)| \geq \epsilon\}.$$

Hence

$$\begin{aligned} F_n(t) &= P(\{\omega \mid x_n(\omega) \leq t\}) \\ &\leq P(\{\omega \mid x(\omega) \leq t + \epsilon\}) + P(\{\omega \mid |x_n(\omega) - x(\omega)| \geq \epsilon\}) \\ &= F(t + \epsilon) + P(\{\omega \mid |x_n(\omega) - x(\omega)| \geq \epsilon\}). \end{aligned}$$

Forming the lim sup on n of this inequality and taking into account the convergence in probability of $\{x_n\}$ to x gives

$$\limsup_n F_n(t) \leq F(t + \epsilon). \quad (*)$$

Similarly we have

$$\{\omega \mid x(\omega) \leq t - \epsilon\} \subseteq \{\omega \mid x_n(\omega) \leq t\} \cup \{\omega \mid |x_n(\omega) - x(\omega)| \geq \epsilon\}.$$

Hence

$$F(t - \epsilon) \leq F_n(t) + P(\{\omega \mid |x_n(\omega) - x(\omega)| \geq \epsilon\}).$$

Forming the lim inf on n of this inequality and taking into account the convergence in probability of $\{x_n\}$ to x gives

$$F(t - \epsilon) \leq \liminf_n F_n(t).$$

Putting this inequality together with (*), we conclude that

$$F(t - \epsilon) \leq \liminf_n F_n(t) \leq \limsup_n F_n(t) \leq F(t + \epsilon).$$

Letting ϵ tend to 0 and taking into account the continuity of F at t , we see that $\lim_n F_n(t)$ exists and equals $F(t)$. \square

6. Portmanteau Lemma

It is sometimes inconvenient to use the definition of convergence in distribution to work with the notion. Fortunately some equivalent formulations are available. Some of these are identified in the following lemma. Fix a probability space (Ω, P) .

Lemma 9.14 (Portmanteau¹⁴ Lemma). Let $\{x_n\}$ be a sequence of random variables on (Ω, P) , and for each n , let F_{x_n} and μ_{x_n} be the corresponding cumulative distribution function and probability distribution of x_n on \mathbb{R} . Let x be another random variable on (Ω, P) , and let F_x and μ_x be the corresponding cumulative distribution function and probability distribution on \mathbb{R} . Then the following statements are equivalent:

- (a) $\{x_n\}$ converges in distribution to x , i.e., $\lim_{n \rightarrow \infty} F_{x_n}(u) = F_x(u)$ at every point u of continuity of F_x ,
- (b) $\lim_{n \rightarrow \infty} E(g(x_n)) = E(g(x))$ for every $g \in C_{\text{com}}(\mathbb{R})$, i.e., $\{\mu_{x_n}\}$ tends to μ_x weak-star against $C_{\text{com}}(\mathbb{R})$,
- (c) $\lim_{n \rightarrow \infty} E(g(x_n)) = E(g(x))$ for every bounded complex-valued continuous function g on \mathbb{R} .

REMARKS. In all three statements (a) through (c), the probability enters only as an overlay of interpretation: the mathematical content concerns only monotone functions and Stieltjes measures. Namely the means in (b) and (c) are nothing more than the integrals with respect to Stieltjes measures given by $E(g(x_n)) = \int_{\mathbb{R}} g d\mu_{x_n}$ and $E(g(x)) = \int_{\mathbb{R}} g d\mu_x$. Integration on the probability space (Ω, P) can be completely avoided by repeated use of Proposition 9.1.

PROOF THAT (a) IMPLIES (b). Let g be any C^1 function in $C_{\text{com}}(\mathbb{R})$, let h be the derivative of g , and let $[a, b]$ be any finite interval of \mathbb{R} containing the support of g in its interior. Integration by parts (Theorem 6.53 of *Basic*) gives

$$\int_a^b F_{x_n}(t)h(t) dt = g(b)F_{x_n}(b) - g(a)F_{x_n}(a) - \int_a^b g d\mu_{x_n} = - \int_a^b g d\mu_{x_n} \quad (*)$$

and similarly $\int_a^b F_x(t)h(t) dt = - \int_a^b g d\mu_x$. As n tends to infinity, (a) says that $F_{x_n}(u)$ tends to $F_x(u)$ at every point of continuity of F_x . This convergence takes place everywhere except on a countable set, necessarily a Borel set of Lebesgue

¹⁴The etymology of the term “portmanteau” in this context is uncertain. The French word “portemanteau” in the early sixteenth century referred to a person who carried a king’s cloak, and a little later the term began to refer to a traveling case, generally with two halves to it, such as would be used in riding horseback. Those definitions by themselves make the word apt for this lemma. In English, Lewis Carroll in 1882 introduced the notion of a “portmanteau word” to refer to a single word obtained by telescoping two words into one, and it can be argued that this lemma, having two ideas that belong together, is akin to a portmanteau word.

measure 0. Also the sequence is uniformly bounded by 1. Since h is bounded and has compact support, $\lim_{n \rightarrow \infty} \int_a^b F_{x_n}(t)h(t) dt = \int_a^b F_x(t)h(t) dt$ by dominated convergence. Consequently

$$\lim_n \int_a^b g d\mu_{x_n} = \int_a^b g d\mu_x. \quad (**)$$

This proves the convergence asserted by (b) for all $g \in C_{\text{com}}^1(\mathbb{R})$.

Let a general member g_0 of $C_{\text{com}}(\mathbb{R})$ be given. Corollary 6.19 and Theorem 6.20 of *Basic* show how to convolve g_0 with the members of an approximate identity of functions in $C_{\text{com}}^\infty(\mathbb{R})$ to obtain a sequence $\{g_m\}$ of members of $C_{\text{com}}^\infty(\mathbb{R})$ such that $\lim_m g_m = g_0$ uniformly. Applying $(**)$ with $g = g_m$ and passing to the limit, we obtain $(**)$ for the general member g_0 of $C_{\text{com}}(\mathbb{R})$. \square

PROOF THAT (b) IMPLIES (c). We make explicit use of the fact that μ_x and all the μ_{x_n} are probability measures. Given $\epsilon > 0$, choose a finite open interval I in \mathbb{R} with $\mu_x(I) \geq 1 - \epsilon$, and fix $h \in C_{\text{com}}(\mathbb{R})$ with values in $[0, 1]$ that is 1 on I . Then $1 - h$ has values in $[0, 1]$ and is nonzero only on $\mathbb{R} - I$. So $\int_{\mathbb{R}} (1 - h) d\mu_x \leq \mu_x(\mathbb{R} - I) = 1 - \mu_x(I) \leq \epsilon$. From $\lim \int_{\mathbb{R}} h d\mu_{x_n} = \int_{\mathbb{R}} h d\mu_x$ and $\int_{\mathbb{R}} 1 d\mu_{x_n} = \mu_{x_n}(\mathbb{R}) = 1 = \mu_x(\mathbb{R}) = \int_{\mathbb{R}} 1 d\mu_x$, we obtain

$$\limsup_n \int_{\mathbb{R}} (1 - h) d\mu_{x_n} = \int_{\mathbb{R}} (1 - h) d\mu_x \leq \epsilon.$$

For any continuous function g on \mathbb{R} with $0 \leq g \leq 1$, we can write $g = gh + g(1 - h)$ and obtain

$$\begin{aligned} & \left| \int_{\mathbb{R}} g d\mu_{x_n} - \int_{\mathbb{R}} g d\mu_x \right| \\ & \leq \left| \int_{\mathbb{R}} gh d\mu_{x_n} - \int_{\mathbb{R}} gh d\mu_x \right| + \int_{\mathbb{R}} (1 - h)g d\mu_{x_n} + \int_{\mathbb{R}} (1 - h)g d\mu_x \\ & \leq \left| \int_{\mathbb{R}} gh d\mu_{x_n} - \int_{\mathbb{R}} gh d\mu_x \right| + \int_{\mathbb{R}} (1 - h) d\mu_{x_n} + \int_{\mathbb{R}} (1 - h) d\mu_x. \end{aligned}$$

Since $\lim_n \int_{\mathbb{R}} gh d\mu_{x_n} = \int_{\mathbb{R}} gh d\mu_x$, it follows that

$$\limsup_n \left| \int_{\mathbb{R}} g d\mu_{x_n} - \int_{\mathbb{R}} g d\mu_x \right| \leq 2\epsilon.$$

Because ϵ is arbitrary, $\lim_n \int_{\mathbb{R}} g d\mu_{x_n} = \int_{\mathbb{R}} g d\mu_x$. Taking linear combinations of such functions g allows us to conclude that $\lim_n \int_{\mathbb{R}} g d\mu_{x_n} = \int_{\mathbb{R}} g d\mu_x$ for every bounded continuous complex-valued function g on \mathbb{R} . \square

PROOF THAT (c) IMPLIES (a). Suppose that $\lim_n \int_{\mathbb{R}} g d\mu_{x_n} = \int_{\mathbb{R}} g d\mu_x$ for all bounded continuous g on \mathbb{R} , and let u_0 be a point of continuity of F . We shall prove that $\lim_n F_{x_n}(u_0) = F_x(u_0)$.

For each subset S of \mathbb{R} , let I_S denote the indicator function of S . Fix a positive integer N . For all bounded continuous g on \mathbb{R} with

$$I_{(-\infty, u_0]} \leq g \leq I_{(-\infty, u_0 + 1/N)},$$

integration of the left inequality with respect to μ_{x_n} and of the right inequality with respect to μ_x yields

$$F_{x_n}(u_0) = \mu_{x_n}((-\infty, u_0]) \leq \int_{\mathbb{R}} g d\mu_{x_n}$$

and
$$\int_{\mathbb{R}} g d\mu_x \leq \mu_x((-\infty, u_0 + 1/N]) = F_x(u_0 + 1/N).$$

Thus

$$\limsup_n F_{x_n}(u_0) \leq \limsup_n \int_{\mathbb{R}} g d\mu_{x_n} = \int_{\mathbb{R}} g d\mu_x \leq F_x(u_0 + 1/N).$$

Since N is arbitrary and F_x is right continuous at u_0 ,

$$\limsup_n F_{x_n}(u_0) \leq F_x(u_0). \quad (*)$$

Fix a positive integer M . If g is a continuous function on \mathbb{R} taking values in $[0, 1]$ and satisfying

$$I_{(-\infty, u_0 - 1/M]} \leq g \leq I_{(-\infty, u_0]}$$

then integration of the left inequality with respect to μ_x and of the right inequality with respect to μ_{x_n} yields

$$F_x(u_0 - 1/M) \leq \int_{\mathbb{R}} g d\mu_x \quad \text{and} \quad \int_{\mathbb{R}} g d\mu_{x_n} \leq F_{x_n}(u_0).$$

Thus

$$F_x(u_0 - 1/M) \leq \int_{\mathbb{R}} g d\mu_x = \lim_n \int_{\mathbb{R}} g d\mu_{x_n} \leq \liminf_n F_{x_n}(u_0).$$

Since M is arbitrary and F is left continuous at u_0 ,

$$F_x(u_0) \leq \liminf_n F_{x_n}(u_0).$$

In combination with (*), this inequality completes the proof. \square

7. Characteristic Functions

Throughout this section, (Ω, P) denotes a probability space. Let x be a random variable, and let μ_x be its probability distribution. The function on \mathbb{R} given as the Fourier transform of μ_x is called¹⁵ the **characteristic function** of x and is denoted by φ_x :

$$\varphi_x(t) = \int_{\mathbb{R}} e^{-2\pi i t u} d\mu_x(u).$$

The notion of the Fourier transform of a finite measure on \mathbb{R} was introduced in Problem 6 of Chapter VIII of *Basic*. Among other things, that problem observed that

- (a) such functions are bounded and continuous,
- (b) the only measure whose Fourier transform is 0 is the 0 measure.

Let us notice also that

- (c) $\varphi_x(0) = 1$,
- (d) $\varphi_{ax}(t) = \varphi_x(at)$.

Conclusion (d) follows from the chain of equalities

$$\begin{aligned} \varphi_x(at) &= \int_{\mathbb{R}} e^{-2\pi i (at)u} d\mu_x(u) = \int_{\Omega} e^{-2\pi i (at)x(\omega)} dP(\Omega) \\ &= \int_{\Omega} e^{-2\pi i t(ax)(\omega)} dP(\Omega) = \int_{\mathbb{R}} e^{-2\pi i t u} d\mu_{ax}(u). \end{aligned}$$

Conclusion (a) will be re-proved in the course of the proof of the Proposition 9.16 below.

Characteristic functions provide a viewpoint for studying probability distributions that emphasizes aspects of the distributions that are not readily apparent from their definitions. We shall see, for example, in the Levy Continuity Theorem (Theorem 9.18 below) that convergence in distribution of random variables is mirrored conveniently in convergence of the characteristic functions of the random variables. This equivalence will be a key step in establishing the Central Limit Theorem in Section 9.

Lemma 9.15. For all real x , $|x^{-1}(e^{ix} - 1)| \leq 2$.

¹⁵Some other authors use the term “characteristic function” to refer to a function that is 1 on some set and 0 on the complement; we have referred to this kind of function systematically as an indicator function. Still other authors use a definition of “characteristic function” involving different constants from ours, in order to be consistent with their own particular definition of the Fourier transform of a function.

PROOF. Since $|e^{ix} - 1| = |e^{-ix} - 1|$, we may assume that $x > 0$. Also we may assume that $x \leq 1$ because $x \geq 1$ certainly implies $|x^{-1}(e^{ix} - 1)| \leq 2$. For $0 < x \leq 1$, we use Taylor's Theorem (Theorem 1.36 of it Basic) in the form

$$f(x) = f(0) + f'(0)x + \int_0^x f''(s)(x-s) ds$$

with $f(x) = e^{ix}$. Since $f'(0) = i$ and $|f''(s)| = 1$,

$$|e^{ix} - 1| \leq |x| + \int_0^x |x-s| ds = |x| + \frac{1}{2}|x|^2 \leq |x| + \frac{1}{2}|x| \leq 2|x|. \quad \square$$

Proposition 9.16. Let x be a random variable on the probability space (Ω, P) , and let φ_x be its characteristic function. Then φ_x is bounded and continuous. For each integer $n \geq 1$ such that $E(x^n)$ exists, the function φ_x has n continuous derivatives and the n^{th} derivative $\varphi_x^{(n)}$ is given by n -fold differentiation under the integral defining φ_x , namely as $(-2\pi i)^n \int_{\mathbb{R}} e^{-2\pi i t u} u^n d\mu_x(u)$. In this case the absolute value of the n^{th} derivative $\varphi_x^{(n)}$ is bounded by $(2\pi)^n E(|x^n|)$.

PROOF. Let us prepare for an induction by carrying out a preliminary continuity step and a preliminary differentiation step. Suppose that G is an integrable function on \mathbb{R} with respect to μ_x , and let $H(t) = \int_{\mathbb{R}} e^{-2\pi i t u} G(u) d\mu_x(u)$. Then

$$H(t) - H(t_0) = \int_{\mathbb{R}} (e^{-2\pi i(t-t_0)u} - e^{-2\pi i t_0 u}) e^{-2\pi i t_0 u} G(u) d\mu_x(u),$$

and

$$|H(t) - H(t_0)| \leq \int_{\mathbb{R}} |e^{-2\pi i(t-t_0)u} - e^{-2\pi i t_0 u}| |G(u)| d\mu_x(u).$$

The difference of exponentials is bounded by 2, and the rest of the integrand is a fixed integrable function. Thus as t tends to t_0 , we have dominated convergence, and continuity of H at t_0 follows. This completes the preliminary continuity step.

For the preliminary differentiation step. The difference quotient leading toward the derivative of $H(t) = \int_{\mathbb{R}} e^{-2\pi i t u} G(u) d\mu_x(u)$ is

$$\begin{aligned} h^{-1}[H(t+h) - H(t)] &= \frac{1}{h} \left[\int_{\mathbb{R}} (e^{-2\pi i(t+h)u} - e^{-2\pi i t u}) G(u) d\mu_x(u) \right] \\ &= \int_{\mathbb{R}} h^{-1}(e^{-2\pi i h u} - 1) e^{-2\pi i t u} G(u) d\mu_x(u). \\ &= \int_{\mathbb{R}} (2\pi i h u)^{-1} (e^{-2\pi i h u} - 1) (2\pi i u) e^{-2\pi i t u} G(u) d\mu_x(u). \end{aligned}$$

Since Lemma 9.15 shows that $|(2\pi i h u)^{-1} (e^{-2\pi i h u} - 1)| \leq 2$, the integrand is dominated in absolute value by the single function $4\pi |u| |G(u)|$ as t tends to 0. Consequently under the additional assumption that $uG(u)$ is integrable with respect to μ_x , our difference quotient is the integral of functions parametrized by h and dominated by a fixed integrable function. The integrand tends to a limit as

h tends to 0. So again we have dominated convergence, and H is differentiable with value given by differentiation under the integral sign.

With those preparations done, we can induct, starting with $n = 0$ and $G(u) = 1$. The first conclusion gives the continuity of φ_x (as a result of the integrability of 1), and the second shows that if $|u|$ is integrable, then φ'_x is differentiable with derivative given by differentiation under the integral sign. If we assume inductively the integrability of u^{n-1} , then we obtain the continuity of $\varphi_x^{(n-1)}$ immediately. With the additional assumption of integrability of u^n , we obtain the existence of $\varphi_x^{(n)}$ and the formula for computing it. The bound for the absolute value of $\varphi_x^{(n)}$ follows from the derivative formula, since $(2\pi)^n \int_{\mathbb{R}} |u^n| d\mu_x(u)$ equals $(2\pi)^n E(|x^n|)$. \square

Proposition 9.17. If x_1, \dots, x_n are independent random variables, then their characteristic functions satisfy

$$\varphi_{x_1+\dots+x_n} = \varphi_{x_1} \cdots \varphi_{x_n}.$$

Proof. Propositions 9.3 and 9.4 together give

$$\begin{aligned} \varphi_{x_1+\dots+x_n}(t) &= E(e^{-2\pi it(x_1+\dots+x_n)}) = E(e^{-2\pi itx_1} \cdots e^{-2\pi itx_n}) \\ &= E(e^{-2\pi itx_1}) \cdots E(e^{-2\pi itx_n}) = \varphi_{x_1}(t) \cdots \varphi_{x_n}(t). \end{aligned} \quad \square$$

8. Lévy Continuity Theorem

Let (Φ, ω) be a probability space. We shall now reformulate convergence in distribution in terms of characteristic functions.

Theorem 9.18 (Lévy Continuity Theorem). Let $\{x_n\}$ be a sequence of random variables on (Ω, P) , and for each n , let F_{x_n} and φ_{x_n} be the corresponding cumulative distribution function and characteristic function of x_n on \mathbb{R} . Let x be another random variable on (Ω, P) , and let F_x and φ_x be the corresponding cumulative distribution function and characteristic function on \mathbb{R} . Then the following statements are equivalent:

- (a) $\{x_n\}$ converges in distribution to x , i.e., $\lim_{n \rightarrow \infty} F_n(u) = F(u)$ at every point u of continuity of F ,
- (b) $\{\varphi_{x_n}\}$ converges pointwise to φ_x , i.e., $\lim_{n \rightarrow \infty} \varphi_{x_n}(t) = \varphi_x(t)$ for every $t \in \mathbb{R}$.

REMARKS. In both halves of the proof, we let μ_{x_n} and μ_x be the probability distributions corresponding to F_{x_n} and F_x . We make use of the equivalence of (a) and (c) in the Portmanteau Lemma (Lemma 9.14).

PROOF THAT (a) IMPLIES (b). We apply the implication (a) implies (c) of Lemma 9.14. Since $\{x_n\}$ converges in distribution to x , the lemma shows for the function $g(u) = e^{-2\pi i t u}$ that $\lim_n E(g(x_n)) = E(g(x))$, i.e., that

$$\lim_{n \rightarrow \infty} \int_{\mathbb{R}} e^{-2\pi i t u} d\mu_{x_n}(u) = \int_{\mathbb{R}} e^{-2\pi i t u} d\mu_x(u).$$

This is (b) of the present theorem. \square

PROOF THAT (b) IMPLIES (a). Suppose that $\lim_n \varphi_{x_n}(t) = \varphi_x(t)$ pointwise for all $t \in \mathbb{R}$. According to Proposition 8.10 of *Basic*, the Fourier transform operator \mathcal{F} is one-one from the Schwartz space \mathcal{S} of \mathbb{R} onto itself. For ψ in $C_{\text{com}}^{\infty}(\mathbb{R})$, $\mathcal{F}^{-1}\psi$ is therefore a well defined member of \mathcal{S} . In particular it is integrable. Since the functions φ_{x_n} and φ_x are bounded in absolute value by 1, dominated convergence gives

$$\lim_n \int_{\mathbb{R}} \varphi_{x_n}(t) (\mathcal{F}^{-1}\psi)(t) dt = \int_{\mathbb{R}} \varphi_x(t) (\mathcal{F}^{-1}\psi)(t) dt.$$

Substituting for the definitions in this formula, we obtain

$$\begin{aligned} \lim_n \int_{\mathbb{R}} \left(\int_{\mathbb{R}} e^{-2\pi i t u} d\mu_{x_n}(u) \right) (\mathcal{F}^{-1}\psi)(t) dt \\ = \int_{\mathbb{R}} \left(\int_{\mathbb{R}} e^{-2\pi i t u} d\mu_x(u) \right) (\mathcal{F}^{-1}\psi)(t) dt \end{aligned}$$

On the left side of this equation, the integrand in absolute value is just $|\mathcal{F}^{-1}(\psi)(t)|$, and this is integrable for $d\mu_{x_n} \times dt$. Thus we can interchange the integrals and rewrite the left side as

$$\lim_n \int_{\mathbb{R}} \left(\int_{\mathbb{R}} e^{-2\pi i t u} (\mathcal{F}^{-1}\psi)(t) dt \right) d\mu_{x_n}(u) = \lim_n \int_{\mathbb{R}} \psi(u) d\mu_{x_n}(u).$$

Similarly we can rewrite the right side as $\int_{\mathbb{R}} \psi(u) d\mu_x(u)$. Thus we have

$$\lim_n \int_{\mathbb{R}} \psi(u) d\mu_{x_n}(u) = \int_{\mathbb{R}} \psi(u) d\mu_x(u) \quad (*)$$

for every ψ in $C_{\text{com}}^{\infty}(\mathbb{R})$. To complete the proof, let a general member ψ_0 of $C_{\text{com}}(\mathbb{R})$ be given. We argue with an approximate identity of functions in $C_{\text{com}}^{\infty}(\mathbb{R})$ as at the end of the proof that (a) implies (b) in Lemma 9.14 to see that (*) extends to be valid when ψ is replaced by ψ_0 . Because (b) implies (a) in Lemma 9.14, the validity of (*) for all ψ_0 in $C_{\text{com}}(\mathbb{R})$ completes the proof. \square

9. Central Limit Theorem

We come to the main result of the chapter. Again (Ω, P) denotes a probability space.

Theorem 9.19 (Central Limit Theorem). If $\{x_n, n \geq 1\}$ is a sequence of identically distributed independent random variables on the probability space (Ω, P) with common mean μ and common nonzero finite variance σ^2 and if s_n denotes their partial sums $s_n = \sum_{k=1}^n x_k$, then as n tends to infinity, the random variables $\sqrt{n}(n^{-1}s_n - \mu)$ converge in distribution to a random variable whose cumulative distribution function has derivative $\frac{1}{\sigma\sqrt{2\pi}} e^{-u^2/(2\sigma^2)}$. In particular,

$$\lim_{n \rightarrow \infty} P\left(\omega \mid a < \sqrt{n}(n^{-1}s_n(\omega) - \mu) < b\right) = \frac{1}{\sigma\sqrt{2\pi}} \int_a^b e^{-u^2/(2\sigma^2)} du$$

whenever a and b are real numbers with $a < b$.

REMARKS. The probability distribution with density $\frac{1}{\sigma\sqrt{2\pi}} e^{-(t-\mu)^2/2\sigma^2} dt$ is called the **normal distribution** with mean μ and variance σ^2 . It is commonly denoted by $N(\mu, \sigma^2)$. Theorem 9.19 identifies the limiting distribution under the conditions of the theorem as $N(0, \sigma^2)$. The graph of the density function of $N(\mu, \sigma^2)$ is a familiar bell-shaped curve. Figure 9.1 shows this curve for the case that $\mu = 0$ and $\sigma = 1$.

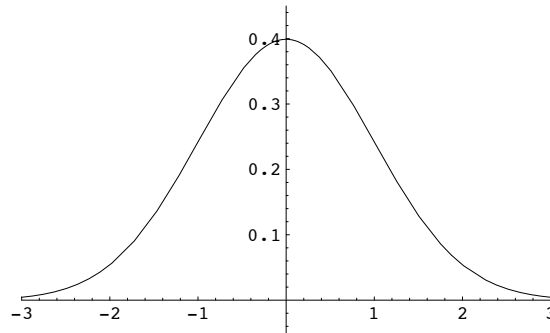

FIGURE 9.1. Graph of the density of the normal distribution $N(0, 1)$, namely the graph of $(2\pi)^{-1/2} e^{-u^2/2}$.

The situation with $\sigma^2 = 0$ is a degenerate case of the theorem, and there is still a result. In this case the random variables in question are almost surely constants, the various expressions $\sqrt{n}(n^{-1}s_n - \mu)$ are almost surely 0, and the limiting probability distribution is a point mass at 0.

The notation Φ is often used for the cumulative distribution function of $N(0, 1)$:

$$\Phi(t) = \frac{1}{\sqrt{2\pi}} \int_{-\infty}^t e^{-s^2/2} ds,$$

and one can find extensive tables of the values of Φ . A small table of such values appears in Figure 9.2.

t	$\Phi(t) - \Phi(-t)$
0.5	.382925
1.0	.682689
1.5	.866386
2.0	.954500
2.5	.987581
3.0	.997300
3.5	.999535
4.0	.999937

FIGURE 9.2. Approximate values of $\Phi(x) - \Phi(-x)$ for the cumulative distribution function Φ of the normal distribution.

PROOF. Put $y_n = x_n - \mu$. The means of y_n and y_n^2 are

$$E(y_n) = E(x_n) - \mu = 0 \quad \text{and} \quad E(y_n^2) = E(x_n^2) - 2\mu E(x_n) + \mu^2 = E(x_n^2) - \mu^2.$$

Thus the variance of x_n , namely $\text{Var}(x_n) = E(x_n^2) - \mu^2$, is equal to the variance of y_n :

$$\text{Var}(y_n) = E(y_n^2) - E(y_n)^2 = E(y_n^2) = E(x_n^2) - \mu^2 = \text{Var}(x_n).$$

The statement of the theorem writes σ^2 for this quantity.

We shall detect the convergence in question by the Lévy Continuity Theorem, Theorem 9.18. Let φ_y be the common characteristic function of the y_n . Since $E(y_n)$ and $E(y_n^2)$ exist, Proposition 9.16 shows that φ_y is a C^2 function. The Taylor expansion about 0 of a C^2 function φ is given for $t > 0$ by Theorem 1.36 of *Basic* as¹⁶

$$\begin{aligned} \varphi(t) &= \varphi(0) + \varphi'(0)t + \int_0^t (t-s)\varphi''(s) ds \\ &= \varphi(0) + \varphi'(0)t + \frac{1}{2}\varphi''(0)t^2 + \int_0^t (\varphi''(s) - \varphi''(0))(t-s)^2 ds. \end{aligned}$$

For $\varphi = \varphi_y$, Proposition 9.16 shows that $\varphi_y(0) = 1$, $\varphi_y'(0) = 0$, and

$$\varphi_y''(0) = -4\pi^2 \int_{\mathbb{R}} u^2 d\mu_y = -4\pi^2 E(y^2) = -4\pi^2 \sigma^2.$$

Put $\alpha(t) = \int_0^t (\varphi''(s) - \varphi''(0))(t-s)^2 ds / t^2$. Since

$$\left| \int_0^t (\varphi''(s) - \varphi''(0))(t-s)^2 ds \right| \leq \sup_{0 \leq s \leq t} |\varphi''(s) - \varphi''(0)| \left(\frac{1}{2}t^2\right),$$

¹⁶The case $t < 0$ is handled similarly and will be omitted.

$\alpha(t)$ is continuous for $t > 0$ and has $\lim_{t \downarrow 0} \alpha(t) = 0$. We conclude that the expansion of φ_y is

$$\varphi_y(t) = 1 - (2\pi^2\sigma^2 - \alpha(t))t^2. \quad (*)$$

Now we consider the characteristic functions of the random variables $\sqrt{n}(n^{-1}s_n - \mu)$ of the theorem. We have

$$\sqrt{n}(n^{-1}s_n - \mu) = n^{-1/2}\left(\sum_{k=1}^n x_k - n\mu\right) = n^{-1/2}\left(\sum_{k=1}^n y_k\right)$$

Hence

$$\begin{aligned} \varphi_{\sqrt{n}(n^{-1}s_n - \mu)}(t) &= \varphi_{y_1 + \dots + y_n}(t/\sqrt{n}) && \text{by property (d) of} \\ & && \text{characteristic functions} \\ &= \varphi_{y_1}(t/\sqrt{n}) \cdots \varphi_{y_n}(t/\sqrt{n}) && \text{by independence and} \\ & && \text{Proposition 9.17} \\ &= \varphi_y(t/\sqrt{n})^n && \text{by identical distributions} \\ &= (1 - (2\pi^2\sigma^2 - \alpha(t/\sqrt{n}))t^2/n)^n && \text{by (*).} \end{aligned} \quad (**)$$

Let us see that this expression has a nonzero limit as n tends to infinity, t being regarded as fixed. We shall take the logarithm of the expression, write h for $1/n$, and apply the estimate

$$|\log(1 - s) + s| \leq 2s^2. \quad (\dagger)$$

Estimate (\dagger) is valid for $|s| \leq \frac{1}{2}$ by Taylor's Theorem (Theorem 1.36 of *Basic*) applied to the function $\log(1 - s)$ about $s = 0$ and the bound of 4 on its second derivative for $|s| \leq \frac{1}{2}$.

The logarithm of our expression $(**)$ of interest is

$$\begin{aligned} \log(1 - (2\pi^2\sigma^2 - \alpha(t/\sqrt{n}))t^2/n)^n &= n \log(1 - (2\pi^2\sigma^2 - \alpha(t/\sqrt{n}))t^2/n) \\ &= h^{-1} \log(1 - h(2\pi^2\sigma^2 - \alpha(t\sqrt{h}))t^2) \end{aligned}$$

with $h = 1/n$, and (\dagger) says that

$$\begin{aligned} &|\log(1 - h(2\pi^2\sigma^2 - \alpha(t\sqrt{h}))t^2) + h(2\pi^2\sigma^2 - \alpha(t\sqrt{h}))t^2| \\ &\leq 2(h(2\pi^2\sigma^2 - \alpha(t\sqrt{h}))t^2)^2 \end{aligned}$$

if the side condition

$$|h(2\pi^2\sigma^2 - \alpha(t\sqrt{h}))t^2| \leq \frac{1}{2} \quad (\dagger\dagger)$$

is satisfied. Here t is fixed, and $(\dagger\dagger)$ is satisfied for positive h small enough because $\lim_{h \downarrow 0} \alpha(t\sqrt{h}) = 0$. Thus the logarithm of $(**)$ satisfies

$$\begin{aligned} & \left| \log \left(1 - (2\pi^2\sigma^2 - \alpha(t/\sqrt{n}))t^2/n \right)^n + (2\pi^2\sigma^2 - \alpha(t\sqrt{h}))t^2 \right| \\ & \leq 2h((2\pi^2\sigma^2 - \alpha(t\sqrt{h}))t^2)^2, \end{aligned}$$

where $h = 1/n$. The right side tends to 0 as n tends to infinity and h tends to 0, and so does $\alpha(t\sqrt{h})t^2$. Thus

$$\lim_{n \rightarrow \infty} \log \left(1 - (2\pi^2\sigma^2 - \alpha(t/\sqrt{n}))t^2/n \right)^n = -2\pi^2\sigma^2t^2.$$

Since \exp is a continuous function, we can exponentiate both sides and interchange exponential and limit, obtaining

$$\lim_{n \rightarrow \infty} \left(1 - (2\pi^2\sigma^2 - \alpha(t/\sqrt{n}))t^2/n \right)^n = e^{-2\pi^2\sigma^2t^2}.$$

In other words, the characteristic functions of the random variables $\sqrt{n}(n^{-1}s_n - \mu)$ satisfy

$$\lim_{n \rightarrow \infty} \varphi_{\sqrt{n}(n^{-1}s_n - \mu)}(t) = e^{-2\pi^2\sigma^2t^2}$$

pointwise for all t .

To apply Theorem 9.18 and complete the proof, we need to identify a probability measure whose Fourier transform is $e^{-2\pi^2\sigma^2t^2}$. That is, we want the inverse Fourier transform of $e^{-2\pi^2\sigma^2t^2}$. According to Proposition 8.2 of *Basic* and the remarks afterward, the function $e^{-\pi u^2}$ has Fourier transform $e^{-\pi t^2}$, and for $a > 0$, the Fourier transform of the dilate $u \mapsto a^{-1}e^{-\pi a^{-2}u^2}$ is $t \mapsto e^{-\pi a^2t^2}$. Thus the function $\frac{1}{\sigma\sqrt{2\pi}}e^{-u^2/(2\sigma^2)}$ has Fourier transform $e^{-2\pi^2\sigma^2t^2}$. In other words, the sequence $\{\sqrt{n}(n^{-1}s_n - \mu)\}$ of random variables on (Ω, P) converges in distribution to the random variable given by the coordinate function u on the probability space $(\mathbb{R}, \frac{1}{\sigma\sqrt{2\pi}}e^{-u^2/(2\sigma^2)}du)$. \square

EXAMPLES.

(1) Flipping a large number of coins results in a normal distribution for the total number of heads. This special case of the Central Limit Theorem is the Theorem of de Moivre and Laplace and is the subject of Problem 18 at the end of the chapter.

(2) Brownian motion, as discussed near the beginning of Section 3. The collisions of molecules with a microscopic particle impart small changes in the path of a particle, and the overall motion of the particle can be analyzed in a discrete model as a sum of independent random variables. Then it is natural to expect that the motion is governed by the exponential of a quadratic expression, and the formulas of the beginning of Section 3 are forced on the model. This effect comes about from the Central Limit Theorem,

(3) In the Central Limit Theorem, suppose that each of the random variables x_j has the normal distribution $N(0, \sigma^2)$. In this case we can compute exactly what is happening within the proof of the theorem. The characteristic function φ_y of $N(0, \sigma^2)$ is the Fourier transform of the function $(2\pi\sigma^2)^{1/2}e^{-u^2/(2\sigma^2)}$, which is $e^{-2\pi\sigma^2 t^2}$, as was observed near the end of the proof. In other words the function φ_y in the proof is exactly

$$\varphi_y(t) = e^{-2\pi\sigma^2 t^2}.$$

Since $\mu = 0$, we obtain

$$\varphi_{\sqrt{n}(n^{-1}s_n - \mu)}(t) = \varphi_y(t/\sqrt{n})^n,$$

just as in (**) of the proof. We have an exact expression for φ_y , and thus

$$\varphi_{\sqrt{n}(n^{-1}s_n - \mu)}(t) = (e^{-2\pi\sigma^2(t/\sqrt{n})^2})^n = e^{-2\pi\sigma^2 t^2}$$

exactly. Taking the inverse Fourier transform shows that the probability distribution of $\sqrt{n}(n^{-1}s_n - \mu)$ is exactly $\frac{1}{\sigma\sqrt{2\pi}} e^{-u^2/(2\sigma^2)} du$, which is $N(0, \sigma^2)$. In other words, all the terms of the sequence are the same, and the convergence is trivial.

So far in this chapter, we have seen that probability theory establishes models that in principle can be used to generate data about future events. In real-world applications, one wants to work in the opposite direction—taking some data from past events, extracting parameters to be able to construct a probability model, and comparing the given data with what happens in that model. This is the question of statistical inference, a subject in the field of statistics. We look at one aspect of that question in the next section.

10. Statistical Inference and Gosset's t Distribution

The Central Limit Theorem is an important tool used in extracting information in real-world applications. In many practical cases one works with a (very large) population but measures some property in only some of the possible cases, those in a sample. Let us concentrate on the mean value. Typically one wants to estimate the mean value of this property for the whole population but as a practical matter can compute it only for the sample. One then wants to extrapolate and use the mean of the sample as the mean of the whole population. The difficulty is in saying how reliable this extrapolated mean is likely to be, that the answer is within such-and-such interval with a probability of at least a certain amount.¹⁷

¹⁷This interval is often called the **margin of error**. The usual convention unless an author states otherwise is that the probability of being within the margin of error is at least .95.

Examples of such cases are voter preferences for candidates for a particular election and the efficacy of a new drug in medicine. In these examples the population is made up of people, and each person in the sample is associated with a random variable x_n . The possible values of x_n and their probabilities give a probability distribution associated with that person. The Central Limit Theorem then gives an idea what to expect of the general population, *provided the hypotheses of independence and identical distributions are satisfied*.¹⁸

In practice certain known potential dependences need to be taken into account. With voting preferences it is known that a voter's age, gender, income, education, and political affiliation may affect the voting preference. In testing a drug, it is known that a person's age, gender, and health history may affect how well a drug works. The idea is to work with each category separately, assuming that its members are more or less independent, and to apply the Central Limit Theorem to each category. Then the results from the different categories are combined with some weighting. We shall not pursue this question of handling potential dependences but shall concentrate on situations in which the entire population is assumed to be independent and identically distributed.

W. S. Gosset studied this situation in a famous 1908 paper. He was an employee of a brewery in Ireland, and one of his interests was in assessing the chemical properties of barley on the basis of a rather small sample. The opening paragraphs of his paper¹⁹ read as follows:

Any experiment may be regarded as forming an individual of a "population" of experiments which might be performed under the same conditions. A series of experiments is a sample drawn from this population.

Now any series of experiments is only of value in so far as it enables us to form a judgment as to the statistical constants of the population to which the experiments belong. In a greater number of cases the question finally turns on the value of a mean, either directly, or as the mean difference between the two quantities.

If the number of experiments be very large, we may have precise information as to the value of the mean, but if our sample be small, we have two sources of uncertainty: (1) owing to the "error of random sampling" the mean of our series of experiments deviates more or less widely from the mean of the population, and (2) the sample is not sufficiently large to determine what is the law of distribution of individuals. It is usual, however, to assume a normal distribution, because, in a very large number of cases, this gives an approximation

¹⁸There are versions of the Central Limit Theorem that relax the assumptions of independence and identical distributions somewhat, but these versions will not be of concern to us.

¹⁹W. S. Gosset (writing under the pseudonym "Student"), "The probable error of a mean," *Biometrika* 6 (1), 1–25.

so close that a small sample will give no information as to the manner in which the population deviates from normality: since some law of distribution must be assumed it is better to work with a curve whose area and ordinates are tabled, and whose properties are well known. This assumption is accordingly made in the present paper, so that its conclusions are not strictly applicable to populations known not to be normally distributed, yet it appears probable that the deviation from normality must be very extreme to lead to serious error. We are concerned here solely with the first of these two sources of uncertainty.

The usual method of determining the probability that the mean of the population lies within a given distance of the mean of the sample is to assume a normal distribution about the mean of the sample with a standard deviation equal to s/\sqrt{n} , where s is the standard deviation of the sample, and to use tables of the probability integral.

But, as we decrease the number of experiments, the value of the standard deviation found from the sample of experiments becomes itself subject to an increasing error, until judgments reached in this way become altogether misleading.

In routine work

There are other experiments, however, which cannot easily be repeated very often; in such cases it is sometimes necessary to judge the certainty of the results from a very small sample, which itself affords the only indication of the variability. Some chemical, many biological, and most agricultural and large-scale experiments belong to this class, which has hitherto been almost outside the range of statistical inquiry.

. . . The aim of the present paper is to determine the point at which we may use the tables of the probability integral [pertaining to the Central Limit Theorem] in judging of the significance of the mean of a series of experiments, and to furnish alternative tables for use when the number of experiments is too few.

In the language we have been using, Gosset worked with a sample from a large population. His random variables x_1, \dots, x_n picked out some numerical property of each member of a sample of size n from the population. It is helpful to regard each member ω of the underlying probability space Ω as one possible situation, as far as those n random variables are concerned. Gosset assumed that x_1, \dots, x_n were independent and identically distributed, and he assumed further that the common probability distribution of the x_j 's was a normal distribution $N(\mu, \sigma^2)$ in which the mean μ and the variance σ^2 were unknown.²⁰

²⁰In real-life applications the common probability distribution is not likely to be exactly normal, but it is often approximately normal. In this situation the usual practice is to proceed as if the

He introduced the **sample mean**

$$\bar{x}(\omega) = n^{-1}(x_1(\omega) + \cdots + x_n(\omega))$$

and the **sample variance** defined by

$$s(\omega)^2 = \frac{1}{n-1} \sum_{j=1}^n (x_j(\omega) - \bar{x}(\omega))^2,$$

which have

$$E(\bar{x}) = \mu \quad \text{and} \quad E(s^2) = \sigma.$$

The latter equality is what accounts for the coefficient $\frac{1}{n-1}$ in the definition of s^2 . Gosset worked with a random variable

$$t(\omega) = \frac{\bar{x}(\omega) - \mu}{s(\omega)/\sqrt{n}}.$$

It has an interpretation as the difference between the locations of the sample mean and the true mean, divided by the sample standard deviation, all multiplied by the same normalizing factor \sqrt{n} as in the statement of the Central Limit Theorem. In an allusion to Gosset's pseudonym Student, the probability distribution of t is often called **Student's t distribution**, but we shall follow the simpler convention of calling it **Gosset's t distribution**. It has the single parameter n , and for reasons that will emerge below, one refers to it as the t distribution "with $n - 1$ **degrees of freedom**." The t distribution can therefore be used to estimate how likely the true mean is to lie in a given interval about the sample mean.

Theorem 9.20. If $n > 1$ and if x_1, \dots, x_n are independent random variables with the common probability distribution $N(\mu, \sigma^2)$, then the density $f_n(t)$ of the t distribution with $n - 1$ degrees of freedom is given by²¹

$$f_n(t) = \frac{\Gamma(\frac{n}{2})}{\sqrt{(n-1)\pi} \Gamma(\frac{n-1}{2})} \left(1 + \frac{t^2}{n-1}\right)^{-\frac{n}{2}}.$$

The proof will be given at the end of this section. Observe that $f_n(t)$ depends neither on μ nor on σ . Because of this property, Gosset's t distribution is indeed usable for estimating how likely the true mean μ is to lie in a given interval about the sample mean $\bar{x}(\omega)$. We shall give an example in a moment.

distribution were exactly normal but to be aware that some errors may be introduced through the approximation. We shall not pursue this matter.

²¹The formula makes use of the gamma function, defined by $\Gamma(x) = \int_0^\infty t^{x-1} e^{-t} dt$ for $x > 0$. This function was studied in Proposition 6.34 of *Basic*, which showed that $\Gamma(x+1) = x\Gamma(x)$ for $x > 0$, $\Gamma(1) = 1$, $\Gamma(n+1) = n!$ for integers $n \geq 0$, and $\Gamma(\frac{1}{2}) = \sqrt{\pi}$.

The coefficient c_n in the expression for $f_n(t)$ should be viewed as some harmless positive constant; the function $(1 + (n - 1)^{-1}t^2)^{-n/2}$ is integrable on \mathbb{R} , and the coefficient makes $\int_{\mathbb{R}} f_n(t) dt = 1$. If we write c_n separately for n even and n odd, the value is²²

$$c_n = \begin{cases} \frac{(n-2)(n-4)\cdots 5\cdot 3}{2\sqrt{n-1}(n-3)(n-5)\cdots 4\cdot 2} & \text{for } n \text{ odd} \\ \frac{(n-2)(n-4)\cdots 4\cdot 2}{\pi\sqrt{n-1}(n-3)(n-5)\cdots 5\cdot 3} & \text{for } n \text{ even.} \end{cases}$$

Problem 20 at the end of the chapter shows that the coefficient c_n has a finite nonzero limit as n tends to infinity and that

$$\lim_{n \rightarrow \infty} f_n(t) = \frac{1}{\sqrt{2\pi}} e^{-t^2/2},$$

i.e., that $f_n(t)$ converges pointwise to the density of the normal distribution $N(0, 1)$. This convergence is illustrated in Figure 9.3. The density of the t distribution is smaller in the center than that of the normal distribution, and it has larger tails. As n increases, this effect becomes less pronounced.

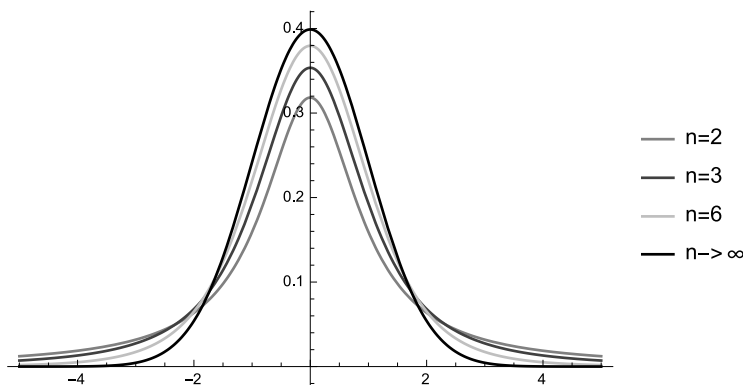

FIGURE 9.3. Normal distribution as a limit of Gosset's t distribution.

The opening of Gosset's 1908 paper mentioned his forming some tables of his distribution for various values of n . He stopped forming these tables with $n = 30$,

²²Many authors refer to $f_n(t)$ and its coefficient c_n by using the number of degrees of freedom $\nu = n - 1$ as parameter and then using $\nu + 1$ in place of n in all tables and formulas. The role of the number of degrees of freedom will become a little clearer in the course of the proof of Theorem 9.20.

apparently regarding the t distribution with 29 degrees of freedom as close enough to the normal distribution $N(0, 1)$ to make further tables unnecessary. Nowadays with high-speed computers, one does need to draw a distinction between small values of n and large values; instead one can use the t distribution in all cases. The table in Figure 9.4 shows the minimal choice of c needed so that $\int_{-c}^c f_n(t) dt$ is $\geq .95$, $\geq .99$, and $\geq .995$.

$n \backslash$ Threshold	.95	.99	.995
2	12.7065	63.6551	127.3447
3	4.3026	9.9247	14.0887
5	2.7764	4.6041	5.5976
7	2.4469	3.7074	4.3168
10	2.2621	3.2498	3.6896
12	2.2010	3.1058	3.4966
15	2.1448	2.9768	3.3257
20	2.0930	2.8609	3.1737
30	2.0452	2.7564	3.0380
50	2.0096	2.6800	2.9397
$\rightarrow \infty$	1.9600	2.5759	2.8071

FIGURE 9.4. Table of approximate minimal values of c such that $\int_{-c}^c f_n(t) dt$ exceeds a threshold.²³

EXAMPLE. A manufacturer of light bulbs claims in its advertising that one type of its bulbs last for 1000 hours. A consumer advocate randomly selects 10 bulbs for testing. The sampled bulbs last a mean of 950 hours with a standard deviation of 50 hours. If the advertising claim were true, what is the probability that 10 randomly selected bulbs would have an average life of no more than 950 hours? To answer this question, we use the given data to compute a t score. The computation gives

$$t = \frac{\bar{x} - \mu}{s/\sqrt{n}} = \frac{950 - 1000}{50/\sqrt{10}} = -\sqrt{10} \approx -3.16,$$

and Figure 9.4 shows that the probability is really small; more precisely the probability is approximately $\int_{-\infty}^{-3.16} f_{14}(t) dt \approx .0058$. The conclusion is that the advertising probably exaggerates the lifetime of the light bulbs.

²³For a larger table see <http://www.easycalculation.com/statistics/t-distribution/t-distribution-critical-value-table.php>, from which this small table was extracted in February 2016.

We turn to the proof of Theorem 9.20, beginning with some preliminary work with some specific probability distributions.

The first of these is the **gamma distribution** with parameters $\alpha > 0$ and $\lambda > 0$. It is given by²⁴

$$\frac{\lambda^\alpha}{\Gamma(\alpha)} x^{\alpha-1} e^{-\lambda x} dx \quad \text{on } (0, +\infty).$$

It is taken to be 0 for $x \leq 0$. To check that this is a probability distribution, we need to check that the coefficient of dx has total integral 1. In fact, the change of variables $y = \lambda x$ gives

$$\frac{\lambda^\alpha}{\Gamma(\alpha)} \int_0^\infty x^{\alpha-1} e^{-\lambda x} dx = \frac{\lambda^\alpha}{\Gamma(\alpha)} \int_0^\infty y^{\alpha-1} \lambda^{1-\alpha} e^{-y} \lambda^{-1} dy = 1,$$

as required.

Lemma 9.21. Suppose that x_1, \dots, x_n are independent random variables and that for $1 \leq j \leq n$, the random variable x_j has the gamma distribution with parameters α_j and λ . Then $x_1 + \dots + x_n$ has the gamma distribution with parameters $\alpha_1 + \dots + \alpha_n$ and λ .

REMARK. The proof will use facts about characteristic functions from Section 7 and also elementary complex analysis as in Appendix B of *Basic*.

PROOF. Fix $\alpha > 0$. For $\operatorname{Re} z > 0$, let $f(z) = \int_0^\infty z^\alpha x^{\alpha-1} e^{-zx} dx$. If z is real and positive, then the change of variables $y = zx$ shows that $f(z) = \int_0^\infty y^{\alpha-1} e^{-y} dy = \Gamma(\alpha)$. In other words, $f(z)$ is the constant $\Gamma(\alpha)$ for z real. Let us show that $f(z)$ is analytic, and then we can conclude that $f(z) = \Gamma(\alpha)$ for all z with $\operatorname{Re} z > 0$.

The integrand for $f(z)$ is continuous for (z, x) in the set $\{\operatorname{Re} z > 0\} \times (0, \infty)$, and it is analytic in the first variable. Lemma B.12 and Corollary B.15 of *Basic* show that $f_{\varepsilon, N}(z) = \int_\varepsilon^N z^\alpha x^{\alpha-1} e^{-zx} dx$ is analytic for $\operatorname{Re} z > 0$ whenever $0 < \varepsilon < N < \infty$, and as ε tends to 0 and N tends to ∞ , $f_{\varepsilon, N}(z)$ converges to $f(z)$ uniformly on compact subsets of z with $\operatorname{Re} z > 0$. Consequently $f(z)$ is analytic for $\operatorname{Re} z > 0$. Since $f(z)$ is constantly equal to $\Gamma(\alpha)$ for z real and positive, $f(z)$ is constantly equal to $\Gamma(\alpha)$ for $\operatorname{Re} z > 0$. Taking $z = \lambda + 2\pi it$ therefore gives

$$\int_0^\infty (\lambda + 2\pi it)^\alpha x^{\alpha-1} e^{-(\lambda+2\pi it)x} dx = \Gamma(\alpha) \quad (*)$$

for all real t .

²⁴Warning: Some authors define the gamma distribution to have parameters α and β , where β is the reciprocal of the parameter λ here.

Now we can compute the characteristic function φ_x of a random variable x having the gamma distribution with parameters α and λ . This is just the Fourier transform of the gamma distribution itself. Specifically

$$\begin{aligned}\varphi_x(t) &= \int_0^\infty \frac{\lambda^\alpha}{\Gamma(\alpha)} x^{\alpha-1} e^{-\lambda x} e^{-2\pi i x t} dx \\ &= \frac{1}{\Gamma(\alpha)} \left(\frac{\lambda}{\lambda + 2\pi i t} \right)^\alpha \int_0^\infty (\lambda + 2\pi i t)^\alpha x^{\alpha-1} e^{-(\lambda + 2\pi i t)x} dx\end{aligned}$$

Applying (*), we see that

$$\varphi_x(t) = \left(\frac{\lambda}{\lambda + 2\pi i t} \right)^\alpha. \quad (**)$$

Finally we can prove the lemma. Equation (**) shows for each j that $\varphi_{x_j}(t) = \left(\frac{\lambda}{\lambda + 2\pi i t} \right)^{\alpha_j}$. The assumed independence and Proposition 9.17 therefore give

$$\varphi_{x_1 + \dots + x_n}(t) = \prod_{j=1}^n \varphi_{x_j}(t) = \prod_{j=1}^n \left(\frac{\lambda}{\lambda + 2\pi i t} \right)^{\alpha_j} = \left(\frac{\lambda}{\lambda + 2\pi i t} \right)^{\alpha_1 + \dots + \alpha_n}.$$

By (**) the right side is the Fourier transform of the gamma distribution with parameters $\alpha_1 + \dots + \alpha_n$ and λ . Since the Fourier transform operator is one-one on $L^1(\mathbb{R})$, $x_1 + \dots + x_n$ has the gamma distribution with parameters $\alpha_1 + \dots + \alpha_n$ and λ . \square

The second specific probability distribution that we need is the distribution of $u_1^2 + \dots + u_k^2$ if u_1, \dots, u_k are independent random variables with the common normal distribution $N(0, 1)$. This called the **chi-square distribution with k degrees of freedom**. The notation $\chi^2(k)$ is used for this distribution.

Lemma 9.22. The chi-square distribution with k degrees of freedom equals the gamma distribution with parameters $\alpha = \frac{k}{2}$ and $\lambda = \frac{1}{2}$ and is given by

$$\frac{1}{2^{k/2} \Gamma(k/2)} x^{k/2-1} e^{-x/2} dx \quad \text{on } (0, \infty).$$

It is 0 for $x \leq 0$.

PROOF. First consider $k = 1$. The statement that u_1 has the distribution $N(0, 1)$ means that the probability distribution of u_1 is

$$(2\pi)^{-1/2} e^{-x^2/2} dx.$$

This implies for $a \geq 0$ and $b > 0$ that

$$P(a < u_1(\omega)^2 < b) = P(\sqrt{a} < |u_1(\omega)| < \sqrt{b}) = 2 \int_{\sqrt{a}}^{\sqrt{b}} (2\pi)^{-1/2} e^{-x^2/2} dx.$$

We apply the change of variables $y = x^2$ and see that the above expression is

$$= 2^{1/2} \int_a^b \pi^{-1/2} e^{-y/2} \frac{1}{2} y^{-1/2} dy = 2^{-1/2} \pi^{-1/2} \int_a^b y^{-1/2} e^{-y/2} dy.$$

From this we can conclude that the probability distribution of u_1^2 is

$$2^{-1/2} \Gamma\left(\frac{1}{2}\right) y^{-1/2} e^{-y/2} dy \quad \text{on } (0, +\infty),$$

which is the gamma distribution with parameters $\alpha = \frac{1}{2}$ and $\lambda = \frac{1}{2}$.

Now consider general k . The independence of u_1, \dots, u_k implies that u_1^2, \dots, u_k^2 are independent, according to Proposition 9.4. Each of them has the gamma distribution with parameters $\alpha = \frac{1}{2}$ and $\lambda = \frac{1}{2}$, and we conclude from Lemma 9.21 that $u_1^2 + \dots + u_k^2$ has the gamma distribution with parameters $\alpha = \frac{k}{2}$ and $\lambda = \frac{1}{2}$. \square

Lemma 9.23. If w and v are independent random variables such that w has the distribution $N(0, 1)$ and v has the distribution $\chi^2(k)$ with $k > 0$, then the random variable t defined by

$$t = \frac{w}{\sqrt{v/k}}$$

has Gosset's t distribution with k degrees of freedom, namely

$$\frac{\Gamma\left(\frac{k+1}{2}\right)}{\sqrt{k\pi} \Gamma\left(\frac{k}{2}\right)} \left(1 + \frac{t^2}{k}\right)^{-\frac{k+1}{2}}$$

REMARKS. In our application of this lemma to the proof of Theorem 9.20, the integer k will be $n - 1$, not n . In the notation of Theorem 9.20, the exact distributions to which the lemma will be applied are

$$w = \frac{\bar{x} - \mu}{\sigma/\sqrt{n}} = \sqrt{n} \left(\frac{\bar{x} - \mu}{\sigma} \right)$$

and
$$v = \frac{(n-1)s^2}{\sigma^2}.$$

To apply the lemma, we shall need to prove that w has probability distribution $N(0, 1)$, v has probability distribution $\chi^2(n-1)$, and w and v are independent.

PROOF. We use the technique of Example 3b in Section 2. By independence the joint probability distribution of (w, v) is

$$\frac{1}{\sqrt{2\pi}} e^{-w^2/2} \frac{1}{2^{k/2}\Gamma(k/2)} v^{k/2-1} e^{-v/2} dw dv \quad \text{on } \mathbb{R} \times (0, +\infty).$$

Define a new random variable t by $t = w/\sqrt{v/k}$, and change variables from (w, v) to (t, u) using the transformation with $t = w/\sqrt{v/k}$ and $u = v$. Here (t, u) lies in $\mathbb{R} \times (0, +\infty)$, and $(w, v) \mapsto (t, u)$ is one-one onto. The inverse transformation has $w = t\sqrt{u/k}$ and $v = u$, and the Jacobian matrix of the inverse transformation is

$$\begin{pmatrix} \partial w/\partial t & \partial w/\partial u \\ \partial v/\partial t & \partial v/\partial u \end{pmatrix} = \begin{pmatrix} \sqrt{u/k} & \frac{1}{2}t/\sqrt{ku} \\ 0 & 1 \end{pmatrix}.$$

Thus $dw dv = \sqrt{u/k} dt du$, and the joint probability distribution in the new variables is

$$\frac{\sqrt{u/k}}{\sqrt{2\pi} 2^{k/2}\Gamma(k/2)} e^{-t^2u/(2k)} u^{k/2-1} e^{-u/2} dt du.$$

To obtain the probability distribution of w , we integrate out the variable u for $u \in \mathbb{R}$. We need to compute

$$\frac{1/\sqrt{k}}{\sqrt{\pi} \Gamma(k/2)} \int_{-\infty}^{\infty} e^{-u(1+t^2/k)/2} (u/2)^{(k+1)/2} u^{-1} du. \quad (*)$$

We use the change of variables $x = u(1+t^2/k)/2$ to see that $(*)$ is

$$\begin{aligned} &= \frac{1}{\sqrt{k\pi} \Gamma(k/2)} \int_{-\infty}^{\infty} e^{-x} x^{(k+1)/2} (1+t^2/k)^{-(k+1)/2} x^{-1} dx \\ &= \frac{\Gamma((k+1)/2)}{\sqrt{k\pi} \Gamma(k/2)} (1+t^2/k)^{-(k+1)/2}, \end{aligned}$$

as required. \square

An n -by- n real matrix A is said to be **orthogonal** if it satisfies $AA^{\text{tr}} = 1$. In this case we have also $A^{\text{tr}}A = 1$. The condition $AA^{\text{tr}} = A^{\text{tr}}A = 1$ is equivalent to the condition that the columns of A are orthogonal under the dot product and have length 1, and similarly for rows. The linear transformation corresponding to an orthogonal matrix preserves volumes and therefore has determinant ± 1 .

Lemma 9.24. Let p_1, \dots, p_n be independent random variables with $N(0, 1)$ as probability distribution, and let A be an n -by- n orthogonal matrix. Then the random variables y_1, \dots, y_n defined by $\begin{pmatrix} y_1 \\ \vdots \\ y_n \end{pmatrix} = A \begin{pmatrix} p_1 \\ \vdots \\ p_n \end{pmatrix}$ are independent and have $N(0, 1)$ as probability distribution.

REMARK. This lemma is an illustration of the principle in Example 4 in Section 2.

PROOF. Write p and y for the respective column vectors $p = (p_1, \dots, p_n)$ and (y_1, \dots, y_n) . The probability distribution of each p_j is $(2\pi)^{-1/2} e^{-p_j^2/2} dp_j$ by assumption. In terms of the dot product, the independence implies that the joint probability distribution of p_1, \dots, p_n is

$$(2\pi)^{-n/2} \prod_{j=1}^n e^{-(p_1^2 + \dots + p_n^2)/2} dp_1 \dots dp_n = (2\pi)^{-n/2} e^{-(p \cdot p)/2} dp_1 \dots dp_n. \quad (*)$$

Since A is an orthogonal matrix, $y \cdot y = Ap \cdot Ap = p \cdot A^T Ap = p \cdot p$, and also $|\det A| = 1$. Thus under the change of variables $y = Ap$, the expression $(*)$ is

$$\begin{aligned} &= (2\pi)^{-n/2} e^{-(y \cdot y)/2} dy_1 \dots dy_n = (2\pi)^{-n/2} \prod_{j=1}^n e^{-(y_1^2 + \dots + y_n^2)/2} dy_1 \dots dy_n \\ &= \prod_{j=1}^n (2\pi)^{-1} e^{-y_j^2/2} dy_j \end{aligned}$$

The fact that the joint probability distribution splits as a product proves the independence of y_1, \dots, y_n , and we can read off from this formula that the probability distribution of y_j is $(2\pi)^{-1} e^{-y_j^2/2} dy_j$, i.e., that y_j has probability distribution $N(0, 1)$. \square

PROOF OF THEOREM 9.20. We define random variables $w = \sigma^{-1} \sqrt{n}(\bar{x} - \mu)$ and $v = \sigma^{-2}(n-1)s^2$ as in the remarks with Lemma 9.23. Then $v/k = v/(n-1) = \sigma^{-2}s^2$, and $\sqrt{v/k} = \sigma^{-1}s$. The quotient in the statement of Lemma 9.23, which is labeled as t , becomes

$$\frac{w}{\sqrt{v/k}} = \frac{\sigma^{-1} \sqrt{n}(\bar{x} - \mu)}{\sigma^{-1}s} = \frac{\bar{x} - \mu}{s/\sqrt{n}}$$

and matches the random variable t in the statement of Theorem 9.20. Theorem 9.20 will therefore follow from Lemma 9.23 if we show that w has probability distribution $N(0, 1)$, v has probability distribution $\chi^2(n-1)$, and w and v are independent.

Let A be any n -by- n orthogonal matrix whose first row has every entry equal to $1/\sqrt{n}$. For example, we can start from

$$B = \begin{pmatrix} \frac{1}{\sqrt{n}} & \frac{1}{\sqrt{n}} & \frac{1}{\sqrt{n}} & \frac{1}{\sqrt{n}} & \dots & \frac{1}{\sqrt{n}} \\ -\frac{1}{2} & \frac{1}{2} & 0 & 0 & \dots & 0 \\ -\frac{1}{3} & -\frac{1}{3} & \frac{2}{3} & 0 & \dots & 0 \\ -\frac{1}{4} & -\frac{1}{4} & -\frac{1}{4} & \frac{3}{4} & \dots & 0 \\ & \vdots & & & \ddots & \vdots \\ -\frac{1}{n} & -\frac{1}{n} & -\frac{1}{n} & -\frac{1}{n} & \dots & \frac{n-1}{n} \end{pmatrix}.$$

Observe that the rows of B are orthogonal under dot product. Define a matrix A to be the same as B except that the j^{th} row, for $j \geq 2$, is to be multiplied by $\sqrt{j/(j-1)}$. Then the rows of A are orthogonal and have length 1, so that A is an orthogonal matrix.²⁵

Define random variables p_j for $1 \leq j \leq n$ by $p_j = \sigma^{-1}(x_j - \mu)$. Proposition 9.4 shows that p_1, \dots, p_n are independent. A change of variables gives

$$\frac{1}{\sqrt{2\pi}} e^{-p_j^2/2} dp_j = \frac{1}{\sigma\sqrt{2\pi}} e^{-(x_j-\mu)^2/(2\sigma^2)} dx_j,$$

and it follows that p_j has probability distribution $N(0, 1)$. Next define random variables y_1, \dots, y_n by $\begin{pmatrix} y_1 \\ \vdots \\ y_n \end{pmatrix} = A \begin{pmatrix} p_1 \\ \vdots \\ p_n \end{pmatrix}$. Lemma 9.24 shows that y_1, \dots, y_n are independent and that each has $N(0, 1)$ as probability distribution. The first of the new random variables is

$$y_1 = \frac{1}{\sqrt{n}}(p_1 + \dots + p_n) = \frac{1}{\sigma\sqrt{n}}(x_1 + \dots + x_n - n\mu) = \frac{\sqrt{n}}{\sigma}(\bar{x} - \mu) = w. \quad (*)$$

In particular, w has probability distribution $N(0, 1)$. We calculate that

$$s^2 = \frac{1}{n-1} \sum_{j=1}^n (x_j - \bar{x})^2 = \frac{1}{n-1} \left(\sum_{j=1}^n x_j^2 - 2\bar{x} \sum_{j=1}^n x_j + n\bar{x}^2 \right) = \frac{1}{n-1} \left(\sum_{j=1}^n x_j^2 - n\bar{x}^2 \right). \quad (**)$$

Consequently

$$\begin{aligned} \sum_{j=2}^n y_j^2 &= \sum_{j=1}^n y_j^2 - \sigma^{-2}n(\bar{x} - \mu)^2 && \text{by } (*) \\ &= \sum_{j=1}^n \left(\frac{x_j - \mu}{\sigma} \right)^2 - \sigma^{-2}n(\bar{x} - \mu)^2 && \text{since } A \text{ is orthogonal} \\ &= \left(\sigma^{-2} \sum_{j=1}^n x_j^2 - 2\sigma^{-2}\mu n\bar{x} + \sigma^{-2}n\mu^2 \right) \\ &\quad + \left(-\sigma^{-2}n\bar{x}^2 + 2\sigma^{-2}n\bar{x}\mu - \sigma^{-2}n\mu^2 \right) \\ &= \sigma^{-2} \sum_{j=1}^n x_j^2 - \sigma^{-2}n\bar{x}^2 \\ &= \sigma^{-2}(n-1)s^2 && \text{by } (**), \\ &= v. \end{aligned}$$

²⁵This particular choice of A is called a **Helmert matrix**. Other choices can be obtained by extending the first row of the above B to a basis of row vectors and then applying the Gram–Schmidt orthogonalization process to the rows as in *Basic*, digital second edition, page 599. All such choices will serve in the present proof.

Since the y_j are independent and each has probability distribution $N(0, 1)$, $v = \sigma^{-2}(n-1)s^2$ is exhibited as a sum of squares of independent random variables each distributed according to $N(0, 1)$, and it has probability distribution $\chi^2(n-1)$. Since w depends only on y_1 and v depends only on y_2, \dots, y_{n-1} , Proposition 9.4 shows that w and v are independent. Lemma 9.23 is therefore applicable with $n = k - 1$, and Theorem 9.20 follows. \square

BIBLIOGRAPHICAL REMARKS ABOUT CHAPTER IX. The proof of Theorem 9.5 is adapted from Doob's *Measure Theory*, and the proof of Theorem 9.8 is adapted from Feller's Volume II of *An Introduction to Probability Theory and Its Applications*. The material in Sections 5–9 is partly adapted from the Wikipedia article “Central Limit Theorem,” as of January 2015, and from the chapter²⁶ “Limit Theorems” of the online *Analysis of Data* project of Guy Lebanon dated 2012. The mathematics in Section 10 is adapted from the chapter²⁷ “Distributions Derived from the Normal Distribution” in the online lecture notes of Barbara Bailey on multivariate statistics from Summer 2009. The organization and overview of Section 10 and the end of Section 9 owe much to conversations with two statisticians, Sarah Knapp Abramowitz and Jon Kettenring.

11. Problems

1. If x is a random variable with probability distribution μ_x , find a formula for the probability distribution $\mu_{|x|}$ of $|x|$ in terms of μ_x .
2. Let x_1, \dots, x_N be random variables on a probability space (Ω, P) , let μ_{x_1, \dots, x_N} be their joint probability distribution, and let $\Phi : \mathbb{R}^N \rightarrow \mathbb{R}$ be a nonnegative Borel function. Prove that

$$\int_{\mathbb{R}} \Phi(t_1, \dots, t_N) d\mu_{x_1, \dots, x_N}(t_1, \dots, t_N) = \int_{\mathbb{R}} s d\mu_{\Phi \circ (x_1, \dots, x_N)}(s),$$

where $\mu_{\Phi \circ (x_1, \dots, x_N)}$ is the probability distribution of $\Phi \circ (x_1, \dots, x_N)$.

3. Suppose on a probability space (Ω, P) that $\{y_n\}_{n=1}^{\infty}$ is a sequence of random variables with a common mean μ and with variance σ_n^2 , and suppose that $\Phi : \mathbb{R} \rightarrow \mathbb{R}$ is a bounded continuous function.
 - (a) Prove that $P(\{|y_n - \mu| \geq \delta\}) \leq \sigma_n^2 \delta^{-2}$ for all n .
 - (b) Suppose that $|\Phi| \leq M$ and that δ and ϵ are positive numbers such that $|t - \mu| < \delta$ implies $|\Phi(t) - \Phi(\mu)| < \epsilon$. Prove that $|E(\Phi(y_n)) - \Phi(\mu)| \leq \epsilon + 2M\sigma_n^2\delta^{-2}$.
 - (c) Prove that if $\lim_n \sigma_n^2 = 0$, then $\lim_n E(\Phi(y_n)) = \Phi(\mu)$.

²⁶This is Chapter 8 of Volume 1.

²⁷This is Chapter 6, and the relevant lectures are Lectures 9 and 11.

- (d) Show that the argument in (c) continues to work if Φ is the indicator function of an interval whose closure does not contain μ . Why does the conclusion in this case contain the conclusion of the Weak Law of Large Numbers as in Theorem 9.7?
4. **(Bernstein polynomials)** This problem gives a constructive proof of the Weierstrass Approximation Theorem by using probability theory.
- (a) Fix p with $0 \leq p \leq 1$. A certain unbalanced coin comes up “heads” with probability p and “tails” with probability $1 - p$; “heads” is scored as the outcome 1, and “tails” is scored as the outcome 0. Set up a probability model (Ω, P) for a sequence of independent coin tosses of this unbalanced coin, and let x_n be the outcome of the n^{th} toss.
- (b) Show that the mean of the outcome of a single toss of the coin is p and the variance is $p(1 - p)$.
- (c) Let $s_n = x_1 + \cdots + x_n$. Show for each integer k with $k \leq n$ that $P(\{s_n = k\}) = \binom{n}{k} p^k (1 - p)^{n-k}$.
- (d) For continuous $\Phi : [0, 1] \rightarrow \mathbb{R}$, extend Φ to all of \mathbb{R} so as to be constant on $(-\infty, 0]$ and on $[1, +\infty)$. Apply the result of Problem 3c to show that $\lim_n \sum_{k=0}^n \Phi\left(\frac{k}{n}\right) \binom{n}{k} p^k (1 - p)^{n-k} = \Phi(p)$.
- (e) Prove that the convergence in (d) is uniform for $0 \leq p \leq 1$, and conclude that Φ is the uniform limit of an explicit sequence of polynomials on $[0, 1]$.

Problems 5–9 are closely related to the Kolmogorov Extension Theorem (Theorem 9.5) and in a sense explain the mystery behind its proof. Let X be a compact metric space, and for each integer $n \geq 1$, let X_n be a copy of X . Define $\Omega^{(N)} = \prod_{n=1}^N X_n$, and let $\Omega = \prod_{n=1}^{\infty} X_n$. Each of $\Omega^{(N)}$ and Ω is given the product topology. If E is a Borel subset of $\Omega^{(N)}$, we can regard E as a subset of Ω by identifying E with $E \times \left(\prod_{n=N+1}^{\infty} X_n\right)$. In this way any Borel measure on $\Omega^{(N)}$ can be regarded as a measure on a certain σ -subalgebra \mathcal{F}_N of the σ -algebra $\mathcal{B}(\Omega)$ of Borel sets.

5. Prove that $\bigcup_{n=1}^{\infty} \mathcal{F}_n = \mathcal{F}$ is an algebra of sets.
6. Let ν_n be a (regular) Borel measure on $\Omega^{(n)}$ with $\nu(\Omega^{(n)}) = 1$, and regard ν_n as defined on \mathcal{F}_n . Suppose for each n that ν_n agrees with ν_{n+1} on \mathcal{F}_n . Define $\nu(E)$ for E in \mathcal{F} to be the common value of $\nu_n(E)$ for n large. Prove that ν is nonnegative additive, and prove that in a suitable sense ν is regular on \mathcal{F} .
7. Using the kind of regularity established in the previous problem, prove that ν is completely additive on \mathcal{F} .
8. In view of Problems 6 and 7, ν extends to a measure on the smallest σ -algebra for Ω containing \mathcal{F} . Prove that this σ -algebra is $\mathcal{B}(\Omega)$.

9. Let X be a 2-point space, and let ν_n be 2^{-n} on each one-point subset of $\Omega^{(n)}$, so that the resulting ν on Ω is coin-tossing measure on the space of all sequences of “heads” and “tails.” Exhibit a homeomorphism of Ω onto the standard Cantor set in $[0, 1]$ that sends ν to the usual Cantor measure, which is the Stieltjes measure corresponding to the Cantor function that is constructed in Section VI.8 of *Basic*.

Problems 10–14 concern the Kolmogorov Extension Theorem (Theorem 9.5) and its application to Brownian motion. If J is a subset of the index set I , a subset A of Ω will be said to be of type J if A can be described by

$$A = x_J^{-1}(E) = \{\omega \in \Omega \mid x_J \in E\} \quad \text{for some subset } E \subseteq S^J.$$

As in the statement of the Kolmogorov theorem, let \mathcal{A}' be the smallest algebra containing all subsets of Ω that are measurable of type F for some finite subset F of I . Let \mathcal{A} be the smallest σ -algebra containing \mathcal{A}' .

10. From the fact that the collection of subsets of Ω that are of type J is a σ -algebra, prove that every set in \mathcal{A} is of type J for some countable set J .
11. Form Brownian motion for time $I = [0, T]$ by means of the Kolmogorov Extension Theorem. Let C be the subset of continuous elements ω in Ω . Prove that C is not in \mathcal{A} .
12. With C as in Problem 11, prove that the only member of \mathcal{A} contained in C is the empty set, and conclude that the inner measure of C relative to P is 0.
13. Still with C as in Problem 11, suppose that E is a subset of Ω of type J for some countable J and that $C \subseteq E$. Prove that the set C_J of elements ω in Ω that are uniformly continuous on J is contained in E .
14. Still with C as in Problem 11, suppose for every countable subset J of I that the set C_J of elements ω in Ω that are uniformly continuous on J is in \mathcal{A} and has $P(C_J) = 1$. Prove that the outer measure of C relative to P is 1.

Problems 15–19 concern methods of convergence and examples of them. In each problem, all random variables are assumed to be defined on a fixed probability space (Ω, P) .

15. Prove that if a sequence of random variables $\{x_n\}$ converges to x in probability, then a subsequence of $\{x_n\}$ converges to x almost surely.
16. Suppose that c is a constant and $\{x_n\}$ is a sequence of random variables such that $E(x_n) = c$ for all n and $\lim_n \text{Var}(x_n) = 0$. Prove that $\{x_n\}$ converges to the constant c in probability.
17. In connection with the implication (b) implies (c) in the Portmanteau Lemma, give an example to show that there exist a sequence $\{\mu_n\}$ of finite Stieltjes measures and another Stieltjes measure μ such that $\lim_n \int_{\mathbb{R}} g d\mu_n = \int_{\mathbb{R}} g d\mu$ for all $g \in C_{\text{com}}(\mathbb{R})$ but not for all bounded continuous g on \mathbb{R} .

18. (**Theorem of de Moivre and Laplace**) The setting of this problem is the same as for Problems 4a–c, the repeated tossing of an unbalanced coin, and the result is the original historical conclusion of the Central Limit Theorem. Using Theorem 9.19, verify that

$$\lim_n P\left(\omega \mid a < (\sqrt{n})^{-1}(s_n(\omega) - np) < b\right) = \frac{\int_a^b \exp\left(-\frac{u^2}{2p(1-p)}\right) du}{\sqrt{2\pi p(1-p)}}.$$

19. For integers $k \geq 0$ and $n \geq 0$ and real λ , define $p_{n,\lambda}(k) = \binom{n}{k} \left(\frac{\lambda}{n}\right)^k \left(1 - \frac{\lambda}{n}\right)^{n-k}$ and $p_\lambda(k) = \frac{\lambda^k}{k!} e^{-\lambda}$.

- (a) Check that $\sum_{k=0}^n p_{n,\lambda}(k) = 1$ and that $\sum_{k=0}^{\infty} p_\lambda(k) = 1$. The probability distribution that assigns weight $p_{n,\lambda}(k)$ to the integer k is called the **binomial distribution** with parameters n and λ , and the probability distribution that assigns weight $p_\lambda(k)$ to the integer k is called the **Poisson distribution** with parameter λ .
- (b) Fix λ , let $x_{n,\lambda}$ be a random variable having probability distribution given by $p_{n,\lambda}$, and let x_λ be a random variable having probability distribution given by p_λ . Prove that $\{x_{n,\lambda}\}$ converges to x_λ in distribution.
- (c) Calculate the mean and variance of x_λ .

20. In Theorem 9.20 write $f_n(t) = c_n \left(1 + \frac{t^2}{n-1}\right)^{-n/2}$, i.e., write c_n for the coefficient in the statement of the theorem. This problem shows that $f_n(t)$ converges pointwise to $(2\pi)^{-1/2} e^{-t^2/2}$, as was asserted just before Figure 9.3.

- (a) Prove for arbitrary $c > 0$ that $s \mapsto (1 + c/s)^s$ is an increasing function of s for $s > 0$.
- (b) Deduce from (a) that $n \mapsto \left(1 + \frac{t^2}{n-1}\right)^{-(n-1)/2}$ decreases to $e^{-t^2/2}$ as n tends to $+\infty$, and explain why it follows that $\lim_{n \rightarrow \infty} c_n^{-1} f_n(t) = e^{-t^2/2}$ pointwise.
- (c) Using the Dominated Convergence Theorem, prove the pointwise limit formula

$$\lim_{n \rightarrow \infty} \int_{\mathbb{R}} \left(1 + \frac{t^2}{n-1}\right)^{-n/2} dt = \int_{\mathbb{R}} e^{-t^2/2} dt,$$

and deduce as a consequence that $\lim_{n \rightarrow \infty} c_n^{-1} = \sqrt{2\pi}$.

21. In the setting in Section 10 of sample size n , let $t_n = (\bar{x} - \mu)/(s/\sqrt{n})$ be the random variable defined before the statement of Theorem 9.20, and let t_∞ be a random variable with distribution $N(0, 1)$. Suppose that the sample size n in Theorem 9.20 is allowed to tend to infinity. Explain how it follows from Problem 20 that the random variables t_n converge to t_∞ in distribution.

Problems 22–26 give a direct computational proof, without characteristic functions, of the Central Limit Theorem (Theorem 9.19) under the assumption that the common distribution of the random variables x_n is normal of type $N(\mu, \sigma^2)$.

22. If c is a constant and if a random variable x has a probability distribution of the form $f(t) dt$, what is the form of the probability distribution of $x + c$?
23. If c is a positive constant and if a random variable x has a probability distribution of the form $f(t) dt$, what is the form of the probability distribution of cx ?
24. If x and y are independent random variables whose respective probability distributions are of the form $f(x) dx$ and $g(x) dx$, it was shown in Example 3b in Section 2 that the probability distribution of $x + y$ is $(f * g)(x) dx$. Under the assumption that x and y are independent and have probability distributions both normal, of the respective forms $N(\mu, \sigma^2)$ and $N(\mu', \sigma'^2)$, show that $x + y$ is normally distributed of the form $N(\mu + \mu', \sigma^2 + \sigma'^2)$.
25. Suppose that $\{x_n, n \geq 1\}$ is a sequence of independent random variables, each with the probability distribution $N(\mu, \sigma^2)$. Find the distribution of the random variable

$$w_n = \sqrt{n} \left(\frac{x_1 + \cdots + x_n}{n} - \mu \right).$$

26. In what sense is the convergence in distribution of the random variables w_n in the previous problem to a random variable with probability distribution $N(0, \sigma^2)$ trivial?

CHAPTER X

Introduction to Wavelets

Abstract. This chapter introduces the relatively recent subject of wavelets, which is an outgrowth of Fourier analysis in mathematics and signal processing in engineering. Except in one case, construction of examples of wavelets tends to be difficult. Much of the chapter is devoted to construction of some of the better known examples and lists of their most important properties.

Section 1 defines wavelets and discusses three features of traditional Fourier analysis: the Uncertainty Principle, Gibbs phenomenon, and the Shannon Sampling Theorem. It ends with a brief essay on the need for wavelets in various applications.

Section 2 establishes that the Haar system is an orthonormal basis of $L^2(\mathbb{R})$. The Haar wavelet predates the general theory of wavelets by many decades but provides a prototype for some of the development. The section ends with some discussion of convergence of one-sided Haar expansions for function spaces besides $L^2(\mathbb{R})$.

Section 3 begins the general theory of wavelets, introducing the notion of multiresolution analysis to abstract the construction in Section 2 of the Haar wavelet. The ingredients of a multiresolution analysis are a scaling function, traditionally called φ , and an increasing sequence of closed subspaces V_j of $L^2(\mathbb{R})$ with certain properties. The wavelet that is constructed is traditionally called ψ .

Section 4 introduces the Shannon wavelet, whose construction is immediate from the theory of multiresolution analyses. The new ingredient here, beyond the ideas used for the Haar wavelet, is the careful use of the generating function of the scaling function to obtain a formula for the wavelet.

Section 5 supplements the theory of Section 3 by showing how to build a multiresolution analysis out of a candidate for the scaling function.

Section 6 introduces the Meyer wavelets, each of which is smooth and has Fourier transform of a prescribed order of differentiability. The full theory of Sections 3 and 5 is used in their construction.

Section 7 introduces splines, examines one example, and sees the need for more theory. It develops one further aspect of the general theory, showing how to replace a “Riesz system” with an orthonormal set. It therefore allows one to relax the conditions needed in Section 5 for a function to be a scaling function. In addition, it uses elementary complex analysis to prove a series expansion for $\pi^2 / \sin^2 \pi z$ that is needed in Section 8.

Section 8 continues the discussion of the role of splines in the theory of wavelets, introducing the Battle–Lemarié wavelets. As with the Meyer wavelets each is smooth and has Fourier transform of a prescribed order of differentiability.

Section 9 develops the Daubechies wavelets. These have compact support, but except for the first one, neither they nor their Fourier transforms have known formulas in closed form. The construction begins by pinpointing necessary conditions on the generating function.

Section 10 deals with smoothness questions. It contains three results. The first gives an estimate for the decay of the Fourier transform of the Daubechies scaling function of each order. The second deduces a certain amount of differentiability of a scaling function from the estimate in the first result. The third shows in the converse direction that a Daubechies wavelet can never be of class

C^∞ . The section concludes with a table summarizing properties of the specific wavelets that have been constructed in Sections 2–9.

Section 11 gives a quick introduction to applications. It discusses the discrete wavelet transform and its use in storage and compression of data, it identifies some applications of wavelets in one and two dimensions, and it makes brief remarks about some of the applications.

1. Introduction

For current purposes a **wavelet** is a function ψ in $L^2(\mathbb{R})$ such that the functions

$$\psi_{j,k}(x) = 2^{j/2}\psi(2^j x - k)$$

form an orthonormal basis of $L^2(\mathbb{R})$ as j and k range through \mathbb{Z} . Such wavelets are called “orthogonal” and “one-dimensional” by some authors. We postpone consideration of modifications of this definition to Section 11 at the end of this chapter.

Corresponding to a wavelet ψ is the wavelet expansion

$$f(x) = \sum_{j,k \in \mathbb{Z}} \left(\int_{\mathbb{R}} f(y) \overline{\psi_{j,k}(y)} dy \right) \psi_{j,k}(x),$$

the series being understood as convergent in $L^2(\mathbb{R})$, independently of the order of the terms. Wavelet expansions allow one to isolate certain hidden features of functions, much as Fourier expansions do, the particular features depending on properties of ψ . Examples of wavelets and their properties will be discussed beginning in Section 2.

To have a practical guide for the theory, it may be helpful to regard a given L^2 function as a “signal,” a function of one real variable t that represents time. The values of the function represent a voltage, positive or negative, or perhaps a mechanical analog of such a voltage. Let us digress for the time being to consider the role of traditional Fourier analysis in understanding such a signal. If we consider the function on all of \mathbb{R} , the Fourier transform has frequency as its variable. Alternatively we can think of masking the function, looking at only those values of t in an interval. If we take that interval to have length 2π , then we can form the Fourier series of the restricted function, and the variable in the result will be the subscript on the Fourier coefficients, telling what multiple of a fundamental frequency is under consideration. Or if we allow ourselves intervals of a more general length T , then we get the kind of Fourier series appropriate to functions of period T .

A two-dimensional analog of a signal is a representation of a two-dimensional picture. If the picture is in black and white, the value of the function at a point

can be the intensity of light at that point. If the picture is in color, the value of the function can be a three-dimensional vector representation of the red, green, and blue values at that point, or by a change of variables, the luminance, the blue chrominance, and the red chrominance values at that point.

Let us begin by mentioning three relevant features of traditional Fourier analysis in this setting. The Fourier transform on $L^2(\mathbb{R})$ is the continuous extension \mathcal{F} from $L^1(\mathbb{R}) \cap L^2(\mathbb{R})$ to $L^2(\mathbb{R})$ of the linear function

$$f \mapsto \widehat{f} \quad \text{given by} \quad \widehat{f}(\omega) = \int_{\mathbb{R}} f(t)e^{-2\pi i t \omega} dt.$$

Then \mathcal{F} is a continuous linear function from $L^2(\mathbb{R})$ onto $L^2(\mathbb{R})$, and it satisfies $\|\mathcal{F}f\|_2 = \|f\|_2$ for all $f \in L^2(\mathbb{R})$. Normally we use \mathcal{F} to refer to all versions of the Fourier transform, completely avoiding using the notation $\widehat{\cdot}$.

The first feature of traditional Fourier analysis is the **Uncertainty Principle**, which says in effect that the amount of detail detected in the time domain limits the amount of detail detectable in the frequency domain. Since our interest is only in illustrating the principle, it will not be necessary for us to seek maximum generality. Accordingly we formulate this result as follows. Fix a member f other than 0 in the Schwartz space $\mathcal{S}(\mathbb{R})$. Then $tf(t)$ and $\omega \mathcal{F}f(\omega)$ are in $\mathcal{S}(\mathbb{R})$, and we can define “mean values” t_0 and ω_0 of t and ω by¹

$$t_0 = \|f\|_2^{-2} \int_{\mathbb{R}} t|f(t)|^2 dt \quad \text{and} \quad \omega_0 = \|f\|_2^{-2} \int_{\mathbb{R}} \omega |\mathcal{F}f(\omega)|^2 d\omega,$$

as well as variances in t and ω by

$$\sigma_{f,t}^2 = \|f\|_2^{-2} \int_{\mathbb{R}} (t - t_0)^2 |f(t)|^2 dt, \quad \sigma_{f,\omega}^2 = \|f\|_2^{-2} \int_{\mathbb{R}} (\omega - \omega_0)^2 |\mathcal{F}f(\omega)|^2 d\omega.$$

Proposition 10.1 (Uncertainty Principle). If f is a nonzero member of $\mathcal{S}(\mathbb{R})$, then

$$\sigma_{f,t}^2 \sigma_{f,\omega}^2 \geq \frac{1}{16\pi^2}.$$

REMARKS. The quantity $\sigma_{f,t}$ is to be regarded as a measure of the time duration of the signal $f(t)$, and $\sigma_{f,\omega}$ is to be regarded as a measure of the frequency dispersion or bandwidth of the signal. The inequality in the proposition is not the only limitation on the time duration of $f(t)$ and the dispersion of $\mathcal{F}f(\omega)$; for example, if f has compact support, then $\mathcal{F}f$ extends to be analytic in the whole complex plane, and the zeros of $\mathcal{F}f$ therefore cannot have a limit point anywhere on the real axis unless $f = 0$.

¹These are the mean values, in the sense of Chapter IX, of the random variables t and ω relative to the probability distributions $\|f\|_2^{-2}|f(t)|^2 dt$ and $\|f\|_2^{-2}|\mathcal{F}f(\omega)|^2 d\omega$, respectively, and similarly for the variances lower down.

PROOF. We treat first the special case that $t_0 = \omega_0 = 0$. Let f' be the derivative of f . Since $\mathcal{F}f'(\omega) = 2\pi i\omega \mathcal{F}f(\omega)$, we have

$$\begin{aligned} \|f\|_2^4 \sigma_{f,t}^2 \sigma_{f,\omega}^2 &= \int_{\mathbb{R}} |tf(t)|^2 dt \int_{\mathbb{R}} |\omega \mathcal{F}f(\omega)|^2 d\omega \\ &= (2\pi)^{-2} \int_{\mathbb{R}} |tf(t)|^2 dt \int_{\mathbb{R}} |\mathcal{F}f'(\omega)|^2 d\omega \\ &= (2\pi)^{-2} \int_{\mathbb{R}} |tf(t)|^2 dt \int_{\mathbb{R}} |f'(t)|^2 dt \\ &\geq (2\pi)^{-2} \left| \int_{\mathbb{R}} (tf(t)\overline{f'(t)}) dt \right|^2 \\ &= (2\pi)^{-2} \left| \int_{\mathbb{R}} \frac{1}{2}t(f(t)\overline{f'(t)} + f'(t)\overline{f(t)}) dt \right|^2 \\ &= (2\pi)^{-2} \left| \int_{\mathbb{R}} \frac{1}{2}t \frac{d}{dt}(f(t)\overline{f(t)}) dt \right|^2, \end{aligned}$$

the inequality holding by the Schwarz inequality. In the integral on the right side, we integrate by parts, differentiating $\frac{1}{2}t$ and integrating $\frac{d}{dt}(f(t)\overline{f(t)})$. The integrated term is 0 because f is a Schwartz function, and the right side simplifies to

$$= \frac{1}{4}(2\pi)^{-2} \left| \int_{\mathbb{R}} -|f(t)|^2 dt \right|^2 = \frac{1}{4}(2\pi)^{-2} \|f\|_2^4.$$

Thus

$$\sigma_{f,t}^2 \sigma_{f,\omega}^2 \geq \frac{1}{16\pi^2},$$

and the proof is complete under the assumption that $t_0 = \omega_0 = 0$.

For the general case, we consider the function

$$g(t) = e^{-2\pi i\omega_0 t} f(t + t_0),$$

which has $\|g\|_2 = \|f\|_2$ and $\mathcal{F}g(\omega) = e^{2\pi i(\omega + \omega_0)t_0} \mathcal{F}f(\omega + \omega_0)$. For g , the mean value of t is

$$\begin{aligned} \mu_{g,t} &= \|f\|_2^{-2} \int_{\mathbb{R}} t |g(t)|^2 dt \\ &= \|f\|_2^{-2} \int_{\mathbb{R}} t |f(t + t_0)|^2 dt \\ &= \|f\|_2^{-2} \int_{\mathbb{R}} (t - t_0) |f(t)|^2 dt = t_0 - t_0 = 0, \end{aligned}$$

and the mean value of ω is

$$\begin{aligned} \mu_{g,\omega} &= \|f\|_2^{-2} \int_{\mathbb{R}} \omega |\mathcal{F}g(\omega)|^2 d\omega \\ &= \|f\|_2^{-2} \int_{\mathbb{R}} \omega |\mathcal{F}f(\omega + \omega_0)|^2 d\omega \\ &= \|f\|_2^{-2} \int_{\mathbb{R}} (\omega - \omega_0) |\mathcal{F}f(\omega)|^2 d\omega = \omega_0 - \omega_0 = 0. \end{aligned}$$

The special case therefore applies to g . The variance in t for g is

$$\begin{aligned} \sigma_{g,t}^2 &= \|g\|_2^{-2} \int_{\mathbb{R}} (t - 0)^2 |g(t)|^2 dt = \|f\|_2^{-2} \int_{\mathbb{R}} t^2 |f(t + t_0)|^2 dt \\ &= \|f\|_2^{-2} \int_{\mathbb{R}} (t - t_0)^2 |f(t)|^2 dt = \sigma_{f,t}^2, \end{aligned}$$

and similarly the variance $\sigma_{g,\omega}^2$ in ω for g equals $\sigma_{f,\omega}^2$. Hence the conclusion in the special case of g gives the desired inequality for f . \square

The second feature of traditional Fourier analysis is **Gibbs phenomenon**. Informally this is the statement that the partial sums of the Fourier series of a nice real-valued function with a jump discontinuity overshoot the expected limit, above and below, by about 9%. The more precise statement is in Proposition 10.2.

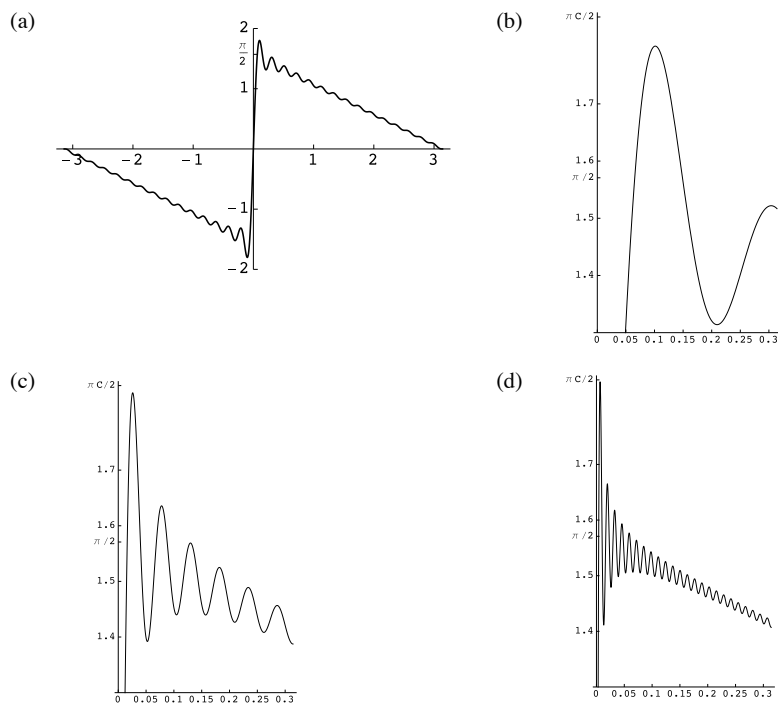

FIGURE 10.1. Gibbs phenomenon for the partial sums of the Fourier series $s_N(f; x)$ when f is continued from $\frac{1}{2}(\pi - x)$ with $0 < x < 2\pi$ so as to have period 2π . (a) Graph of $s_{30}(f; x)$. (b) Detail in graph of $s_{30}(f; x)$, C being ≈ 1.179 . (c) Same detail in graph of $s_{120}(f; x)$. (d) Same detail in graph of $s_{480}(f; x)$.

Proposition 10.2 (Gibbs phenomenon). Let f be a real-valued periodic function of period 2π . Suppose that f is of bounded variation and has an isolated jump discontinuity when $t = t_0$; specifically suppose that the jump $J = \lim_{t \downarrow t_0} f(t) - \lim_{t \uparrow t_0} f(t)$ is > 0 . If $s_N(f; t)$ is the partial sum of the Fourier series of f at t , then

$$\lim_{N \rightarrow \infty} s_N(f; t_0 + \frac{\pi}{N}) - \lim_{N \rightarrow \infty} s_N(f; t_0 - \frac{\pi}{N}) = CJ, \quad \text{the limits existing,}$$

where $C = \frac{2}{\pi} \int_0^\pi (\sin t)/t dt \approx 1.179$.

REMARKS. Thus the overshoot above and below is at least by half of .179 times the size of the jump. The overshoot is illustrated in Figure 10.1, which shows a graph of the 30th partial sum, together with enlargements of a certain portion of the graphs of of the 30th, 120th, and 480th partial sums.

PROOF. Let $g(t)$ be the periodic extension of the function that equals $\frac{1}{2}(\pi - t)$ for $0 < t < 2\pi$. This is periodic of period 2π , is of bounded variation, and is continuous except at the multiples of 2π , where it jumps by π . Thus the function h with $h(t) = f(t) - \pi^{-1}Jg(t - t_0)$ is of bounded variation and is continuous in an interval about $t = t_0$. By Theorem 6.55 of *Basic*, the Fourier series of h converges uniformly to h in an interval about t_0 . Consequently it is enough to consider the function g and the point t_0 ; in this case the jump is $J = \pi$.

From Section I.10 of *Basic*, the Fourier series of g is $\sum_{n=1}^{\infty} \frac{\sin nt}{n}$. If $s_N(g; t)$ denotes the N^{th} partial sum of this series, then

$$s_N(g; \pi/N) = \sum_{n=1}^N \frac{\sin(n\pi/N)}{n},$$

which is a Riemann sum for the Riemann integral of the continuous function $(\sin t)/t$ from 0 to π . The partition is equally spaced with mesh π/N , and the function is evaluated at the right-hand endpoint of each interval of the partition. By Theorem 1.35 of *Basic*,

$$\lim_{N \rightarrow \infty} s_N(g; \pi/N) = \int_0^{\pi} \frac{\sin t}{t} dt = \frac{\pi}{2}C,$$

with C as in the statement of the proposition. Since the periodic function $g(x)$ is odd, we similarly obtain

$$\lim_{N \rightarrow \infty} s_N(g; -\pi/N) = -\frac{\pi}{2}C.$$

Therefore

$$\lim_{N \rightarrow \infty} s_N(g; \pi/N) - \lim_{N \rightarrow \infty} s_N(g; -\pi/N) = \pi C,$$

as asserted. □

The third feature of traditional Fourier analysis concerns “sampling.” As a practical matter, signals in engineering cannot be expected to be known exactly. Realistic information about the signal can be obtained only at certain instants of time, possibly instants that are very close to one another.² To what extent does

²Actually what seems to be the value at an instant of time may really be a kind of average over a very short interval, but we shall ignore this distinction.

the sampled version of the signal determine the signal exactly? The **Shannon Sampling Theorem** gives an answer. It assumes that the signal is “band-limited,” i.e., its Fourier transform vanishes outside some interval. This is a reasonable assumption in practice, since each piece of equipment for studying signals has its own limitations in coping with high frequencies.

Proposition 10.3 (Shannon Sampling Theorem). Suppose that f is a member of $L^2(\mathbb{R})$ whose Fourier transform $\mathcal{F}f$ vanishes outside the interval $[-\frac{1}{2}\Omega, \frac{1}{2}\Omega]$. Then f can be taken to be smooth and satisfies

$$f(t) = \sum_{k=-\infty}^{\infty} f\left(\frac{k}{\Omega}\right) \frac{\sin(\pi(\Omega t - k))}{\pi(\Omega t - k)},$$

the series being convergent in $L^2(\mathbb{R})$ and also uniformly convergent in t .

PROOF. Until the very end we assume that $\Omega = 1$. Since $\mathcal{F}f$ is in $L^2(\mathbb{R})$ and has compact support, it is in $L^1(\mathbb{R})$, and we can recover f from it almost everywhere by means of the formula

$$f(t) = \int_{\mathbb{R}} e^{2\pi i \omega t} (\mathcal{F}f)(\omega) d\omega = \int_{-1/2}^{1/2} e^{2\pi i \omega t} (\mathcal{F}f)(\omega) d\omega. \quad (*)$$

From this formula it follows that f in the variable t is the restriction to \mathbb{R} of an entire function; in particular, f is smooth, and $(*)$ holds for every t . Since $\mathcal{F}f$ is supported on $[-\frac{1}{2}, \frac{1}{2}]$, we can treat it as an L^2 periodic function on $[-\frac{1}{2}, \frac{1}{2}]$ of period 1, and we can expand it in Fourier series as $\mathcal{F}f(\omega) = \sum_{k=-\infty}^{\infty} c_k e^{2\pi i k \omega}$, the series convergent in $L^2([-\frac{1}{2}, \frac{1}{2}])$. Here $c_k = \int_{-1/2}^{1/2} (\mathcal{F}f)(\omega) e^{-2\pi i k \omega} d\omega = f(-k)$, the second equality holding by $(*)$. Thus the Fourier series expansion of $(\mathcal{F}f)(\omega)$ is

$$\mathcal{F}f(\omega) = \sum_{k=-\infty}^{\infty} c_k e^{2\pi i k \omega} = \sum_{k=-\infty}^{\infty} f(-k) e^{2\pi i k \omega} = \sum_{k=-\infty}^{\infty} f(k) e^{-2\pi i k \omega}. \quad (**)$$

Substituting $(**)$ into $(*)$ gives

$$f(t) = \int_{-1/2}^{1/2} e^{2\pi i \omega t} (\mathcal{F}f)(\omega) d\omega = \int_{-1/2}^{1/2} \sum_{k=-\infty}^{\infty} f(k) e^{2\pi i (t-k)\omega} d\omega. \quad (\dagger)$$

If we allow ourselves to interchange sum and integral on the right side and if we assume that t is not an integer, we see that (\dagger) is

$$\begin{aligned} &= \sum_{k=-\infty}^{\infty} f(k) \int_{-1/2}^{1/2} e^{2\pi i (t-k)\omega} d\omega \\ &= \sum_{k=-\infty}^{\infty} f(k) \left[\frac{e^{\pi i (t-k)} - e^{-\pi i (t-k)}}{2\pi i (t-k)} \right] \\ &= \sum_{k=-\infty}^{\infty} f(k) \frac{\sin \pi (t-k)}{\pi (t-k)}, \end{aligned}$$

as required.

Under the assumption that $\Omega = 1$, we are left with justifying the interchange of integral and sum on the right side of (†) and with addressing the restriction $t \notin \mathbb{Z}$. Let $I_E(\omega)$ be the indicator function of $[-\frac{1}{2}, \frac{1}{2}]$, and define c_k as above. Put

$$f_N(t) = \mathcal{F}^{-1}\left(I_E(\omega) \sum_{k=-N}^N c_k e^{2\pi i k \omega}\right)(t) = \mathcal{F}^{-1}\left(I_E(\omega) \sum_{k=-N}^N f(-k) e^{2\pi i k \omega}\right)(t).$$

Since $I_E(\omega) \sum_{k=-N}^N c_k e^{2\pi i k \omega}$ tends to $I_E(\omega)(\mathcal{F}f)(\omega)$ in L^2 and is supported in the fixed bounded set E , it converges also in L^1 , and it follows that its inverse Fourier transform $f_N(t)$ converges uniformly to $f(t)$, as well as in $L^2(\mathbb{R})$. The above interchange of limits works for f_N because the sum is a finite sum, and thus we obtain

$$f_N(t) = \sum_{k=-N}^N f(k) \frac{\sin \pi(t-k)}{\pi(t-k)}$$

for every N . Use of continuity shows that we do not need to assume $t \notin \mathbb{Z}$. Letting N tend to infinity, we obtain the desired identity for $\Omega = 1$ with uniform convergence and convergence in $L^2(\mathbb{R})$.

For general Ω , suppose that f has $\mathcal{F}f(\omega) = 0$ for $|\omega| > \frac{1}{2}\Omega$. Put $g(t) = \Omega^{-1}f(\Omega^{-1}t)$, so that $(\mathcal{F}g)(\omega) = (\mathcal{F}f)(\Omega\omega)$. Then $(\mathcal{F}g)(\omega) = 0$ for $|\omega| > \frac{1}{2}$, and the case proved above applies to g . Then we obtain

$$g(t) = \sum_k g(k) \frac{\sin \pi(t-k)}{\pi(t-k)}.$$

Substitution gives

$$\Omega^{-1}f(\Omega^{-1}t) = \Omega^{-1} \sum_k f(\Omega^{-1}k) \frac{\sin \pi(t-k)}{\pi(t-k)}.$$

Multiplying both sides by Ω and replacing t by Ωt completes the proof. \square

We turn now to wavelets. The subject of wavelets has grown out of many areas, theoretical and applied, and some of the background is quite deep. For example, the dilations by powers of 2 that enter the definition are motivated to an extent by Littlewood–Paley theory, a part of Euclidean Fourier analysis beyond what is discussed in Chapter III of this book. Our approach will be to take the resulting theory as a subject on its own, often without presenting the deep motivation for particular definitions.

Many of the applications of wavelets are to problems of analysis and/or compression of data, possibly with noise reduction. A traditional example of compression, from the days when telephone calls were transmitted over copper wires, is how the voice signals of telephone calls were handled. The telephone company was not content with sending just one signal over a wire. It wanted to send many signals simultaneously. To do so, it filtered each conversation to eliminate frequencies other than those between 300 and 2700 cycles per second and then multiplied the signal by a high-frequency carrier wave to obtain a signal in a high-frequency band of width 2400 cycles per second. Allowing different bands for different conversations allowed it to transmit many conversations at once over the same wires. Some information was lost during this step of compression, including all frequencies outside the band 300 to 2700 cycles per second.

In the setting we are studying, the data can be in analog form, as was the case in the example just given, but let us think of the given data as digital. In the one-dimensional case we then have a digitized signal, perhaps of speech or music or some other kind of sound. In the two-dimensional case, we have an image, perhaps the photographic image produced by a digital camera or an image of a fingerprint. We want to know what is happening in the signal and to process the signal accordingly, perhaps enhancing some parts of it and damping other parts.

If traditional Fourier analysis is to be used, then any compression will likely be achieved by discarding high-frequency information. For example, the JPEG file of a digital photograph³ is obtained by treating the image as built from squares of size 8 pixels by 8 pixels, doing a discrete Fourier analysis on each piece, and discarding some information. For most photographs this method of compression is perfectly adequate, but interactions occur at the boundary between adjacent 8-by-8 squares. At high compression ratios these interactions can produce a visible effect known as “blocking,” and the result can sometimes be disconcerting. On an image like that of a fingerprint, JPEG is distinctly inadequate.

In any of these situations the theory of wavelets is available to handle the analysis and/or processing in a different way. Different wavelets have different advantages, and one may want one kind of wavelet for one situation and another kind for another situation. One study of speech⁴ for designing hearing aids classified short intervals of speech into four possible kinds—“voiced, plosive, fricative, and silent segments”—and it proceeded from there. One of its tools was the Daubechies wavelet of order $N = 3$.

Over the next nine sections we shall construct directly certain wavelets and

³“JPEG” stands for Joint Photographic Experts Group. The committee has a website, namely <https://jpeg.org>.

⁴B. T. Tan, R. Lang, Heiko Schroder, A. Spray, and P. Dermody, “Applying wavelet analysis to speech segmentation and classification,” *Proc. SPIE* (International Society for Optical Engineering) 2242 (1994), Orlando, FL, 750–761.

families of wavelets, extracting properties of each. We construct the first historical example of a wavelet in Section 2 and develop a fairly general method of constructing wavelets in Section 3. Subsequently we shall make refinements to the construction. Applying the method and its refinements, we obtain several important explicit families of wavelets in Sections 4–9. All along, we shall observe certain properties of these families; these properties influence the usefulness of the various families for certain kinds of applications. Section 10 completes the derivation of the properties, and a table listing the names of the families and summarizing the properties appears as Figure 10.18.

In Section 11 we shall take a look at the wavelet transform. Analyzing the nature of the transform and of its calculation gives an inkling of how to take advantage of wavelets in analyzing signals. At the end of the section, we make some remarks about one-dimensional applications and also about two-dimensional wavelets and their use in improving the JPEG algorithm and the compression of fingerprint records. The applications to images involve a new wrinkle in that the sight of asymmetries appears to be more noticeable than one might at first expect. As a result it is desirable for wavelets involved in image processing to be symmetric in a certain sense. This symmetry is impossible for compactly supported orthogonal wavelets, and some relaxation of the definition is warranted.

In the end, analysis using wavelets is one tool in signal processing; Fourier analysis is another. There are also others. One should not think of wavelet analysis as a substitute for these other methods, however. As Y. Meyer put it in his groundbreaking book⁵ listed in the Selected References, “But wavelet analysis cannot entirely replace Fourier analysis, indeed, the latter is used in constructing the orthonormal bases of wavelets needed for analysis with wavelet series.”

2. Haar Wavelet

The **Haar system** is the system of functions in $L^2(\mathbb{R})$ defined by

$$\psi_{j,k}(x) = 2^{j/2} \psi(2^j x - k) \quad \text{for } j \text{ and } k \text{ in } \mathbb{Z},$$

where ψ is the function in $L^2(\mathbb{R})$ defined by

$$\psi(x) = \begin{cases} 1 & \text{if } 0 \leq x < \frac{1}{2}, \\ -1 & \text{if } \frac{1}{2} \leq x < 1, \\ 0 & \text{otherwise.} \end{cases}$$

In this section we shall prove the following result and consider some of its ramifications.

⁵Y. Meyer, *Wavelets and Operators*, p. 1.”

Theorem 10.4. The Haar system is an orthonormal basis of $L^2(\mathbb{R})$.

Therefore the above function ψ is a wavelet for what is called the **Haar system**, and one refers to ψ as the **Haar wavelet**. Any integer translate $\psi_{0,k}$ of $\psi = \psi_{0,0}$ would serve equally well for this purpose. The proof will make use of an auxiliary function φ in $L^2(\mathbb{R})$ called the **scaling function** for the system. The Haar scaling function φ is the indicator function of the interval $[0, 1)$, namely

$$\varphi(x) = \begin{cases} 1 & \text{if } 0 \leq x < 1, \\ 0 & \text{otherwise.} \end{cases}$$

In notation analogous to that for ψ , we introduce the system of functions

$$\varphi_{j,k}(x) = 2^{j/2} \varphi(2^j x - k) \quad \text{for } j \text{ and } k \text{ in } \mathbb{Z}.$$

Graphs of φ and ψ appear in Figures 10.2a and 10.2b.

The details of the proof of Theorem 10.4 are of some importance for other systems as well as the Haar system, and we shall therefore give the proof in steps and extract some further information from it after it is complete.

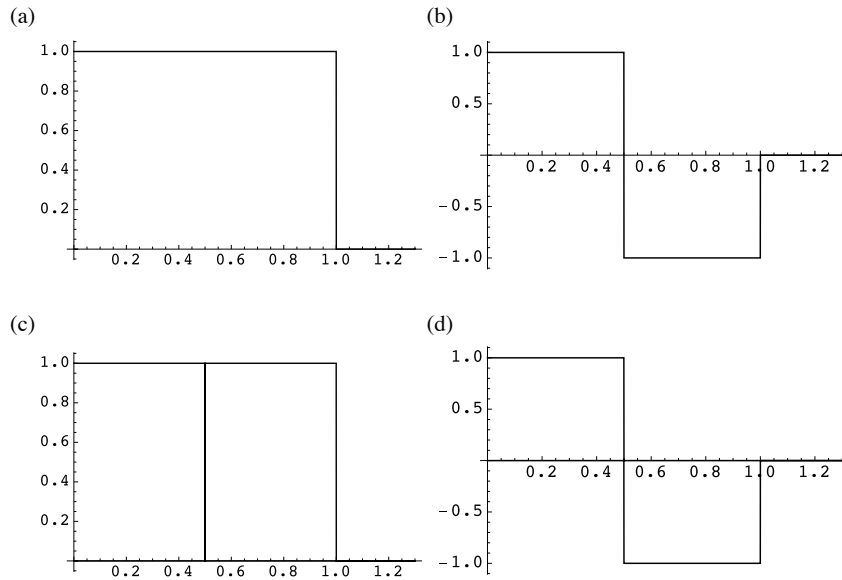

FIGURE 10.2. Graphs of Haar scaling function and wavelet.

(a) $\varphi(x)$. (b) $\psi(x)$. (c) $\varphi(x) = \varphi(2x) + \varphi(2x - 1)$.

(d) $\psi(x) = \varphi(2x) - \varphi(2x - 1)$.

PROOF OF THEOREM 10.4.

Step 1. We prove that $\{\psi_{j,k}\}$ is an orthonormal system.

The functions being real, we can drop all references to complex conjugation. Using the change of variables $2^j x - k = y$, which has $x = 2^{-j}(y + k)$ and $dx = 2^{-j} dy$, we examine the integral

$$\begin{aligned} \int_{\mathbb{R}} \psi_{j,k}(x) \psi_{m,n}(x) dx &= \int_{\mathbb{R}} 2^{(j+m)/2} \psi(2^j x - k) \psi(2^m x - n) dx, \\ &= \int_{\mathbb{R}} 2^{(-j+m)/2} \psi(y) \psi(2^{m-j}(y + k) - n) dy. \end{aligned}$$

If $j = m$, this reduces to

$$= \int_{\mathbb{R}} \psi(y) \psi(y + k - n) dy;$$

for $k = n$, the integrand is $\psi(y)^2 = \varphi(y)$, and the integral is 1, while for $k \neq n$, the two factors of the integrand are nonzero on disjoint sets and the integral is 0. If $j \neq m$, we may assume by symmetry that $r = m - j$ is > 0 . Then it is enough to show that

$$\int_{\mathbb{R}} \psi(y) \psi(2^r y + t) dy$$

is 0 for $r > 0$ when t is any integer. Under the change of variables $2^r y + t = u$, $dy = 2^{-r} du$, this integral becomes

$$\begin{aligned} &= \int_0^{1/2} \psi(2^r y + t) dy - \int_{1/2}^1 \psi(2^r y + t) dy \\ &= 2^{-r} \int_t^{2^{r-1}+t} \psi(u) du - 2^{-r} \int_{2^{r-1}+t}^{2^r+t} \psi(u) du. \end{aligned}$$

Each of the integrals on the right side is an integral of ψ over an interval of integer length, and any such integral is 0. This completes the proof of orthonormality.

Step 2. If V_0 is the closed subspace of members of $L^2(\mathbb{R})$ that are constant almost everywhere on each interval $[k, k + 1)$ with k in \mathbb{Z} , then the functions $x \mapsto \varphi(x - k)$ form an orthonormal basis of V_0 .

In fact, the function $x \mapsto \varphi(x - k)$ is 1 on $[k, k + 1)$ and is 0 otherwise. Its square integral is therefore 1, and the inner product of any two distinct such functions is 0. Thus the set of functions $x \mapsto \varphi(x - k)$ is orthonormal. Since the vector space of finite linear combinations of the functions $x \mapsto \varphi(x + k)$ is dense in V_0 , it follows that the set of functions $x \mapsto \varphi(x - k)$ is an orthonormal basis of V_0 .

Step 3. We construct some closed subspaces V_j of $L^2(\mathbb{R})$ for $j \geq 1$, we observe for each j that the functions $\varphi_{j,k}$, as k varies, form an orthonormal basis of V_j , and we note some properties of V_j .

We let V_j be the set of functions in $L^2(\mathbb{R})$ that are constant almost everywhere on each interval $[2^{-j}k, 2^{-j}(k+1))$. Then it is plain that for all $j \geq 0$,

$$V_j \subseteq V_{j+1} \quad (*)$$

and

$$f(x) \text{ is in } V_j \text{ if and only if } f(2x) \text{ is in } V_{j+1}. \quad (**)$$

Arguing as in Step 2, we see for each $j \geq 0$ that the set of functions

$$x \mapsto \varphi_{j,k}(x) \text{ is an orthonormal basis of } V_j. \quad (\dagger)$$

Step 4. We prove that $\bigcup_{j=0}^{\infty} V_j$ is dense in $L^2(\mathbb{R})$.

In fact, suppose $f \in L^2(\mathbb{R})$ is to be approximated, and let $\epsilon > 0$ be given. Corollary 6.4 of *Basic* shows that $C_{\text{com}}(\mathbb{R})$ is dense in $L^2(\mathbb{R})$. Thus we can choose $g \in C_{\text{com}}(\mathbb{R})$ with $\|f - g\|_2 < \epsilon$. Let E be the support of g . Since g is uniformly continuous on the compact set E and hence on all of \mathbb{R} , we can find a negative power of 2, say 2^{-l} , small enough so that $|x - y| < 2^{-l}$ implies $|g(x) - g(y)| < \epsilon/|E|^{1/2}$, where $|E|$ is the measure of E . Define a function $h(x)$ to equal $g(n2^{-l})$ for $n2^{-l} \leq x < (n+1)2^{-l}$. Then h is in V_l , and h satisfies an estimate

$$|g(x) - h(x)| = |g(x) - g(n2^{-l})| < \epsilon/|E|^{1/2} \quad \text{for } x \in [n2^{-l}, (n+1)2^{-l})$$

and hence for all x . Then

$$\|g - h\|_2^2 \leq |E|(\epsilon/|E|^{1/2})^2 \leq \epsilon^2,$$

and hence $\|g - h\|_2 \leq \epsilon$. Therefore $\|f - h\|_2 < 2\epsilon$, and $\bigcup_{j=0}^{\infty} V_j$ is dense in $L^2(\mathbb{R})$.

Step 5. We construct some closed subspaces W_j of $L^2(\mathbb{R})$ for $j \geq 0$, and we examine the properties of W_j .

Let us define W_j for $j \geq 0$ to be the orthogonal complement of V_j in V_{j+1} . For $j \geq 0$, let us check that

$$f(x) \text{ is in } W_j \text{ if and only if } f(2x) \text{ is in } W_{j+1}. \quad (\dagger\dagger)$$

In fact, if $f(x)$ is in W_j , then it is in V_{j+1} . So $f(2x)$ is in V_{j+2} . If $g(x)$ is in V_{j+1} , then $g(\frac{1}{2}x)$ is in V_j by (**), and it has $\int_{\mathbb{R}} f(2x)g(x) dx = 2 \int_{\mathbb{R}} f(x)g(\frac{1}{2}x) dx = 0$. Hence $f(2x)$ is in the orthogonal complement of V_{j+1} in V_{j+2} , which is W_{j+1} .

In the reverse direction if $f(2x)$ is in W_{j+1} , then $f(2x)$ is in V_{j+2} , and (**) shows that $f(x)$ is in V_{j+1} . Every $g(x)$ in V_{j+1} has $0 = \int_{\mathbb{R}} f(2x)g(x) dx =$

$\frac{1}{2} \int_{\mathbb{R}} f(x)g(\frac{1}{2}x) dx$. The function $g(\frac{1}{2}x)$ is the most general element of V_j by (**), and thus $f(x)$ is in W_j . This proves (††).

Let us write \perp for orthogonal direct sum. For $n \geq 0$, we then have

$$\begin{aligned} V_n &= V_{n-1} \perp W_{n-1} = V_{n-2} \perp (W_{n-2} \perp W_{n-1}) \\ &= V_{n-3} \perp (W_{n-3} \perp W_{n-2} \perp W_{n-1}) \\ &= \cdots = V_0 \perp (W_0 \perp W_1 \perp \cdots \perp W_{n-1}). \end{aligned} \quad (\ddagger)$$

Step 6. We observe that φ is in V_0 , that ψ is in V_1 , that the functions φ and ψ satisfy the equations

$$\varphi(x) = \varphi(2x) + \varphi(2x - 1)$$

and

$$\psi(x) = \varphi(2x) - \varphi(2x - 1),$$

and that ψ is in W_0 . These equations are reflected in the graphs appearing in Figures 10.2c and 10.2d.

The facts that φ is in V_0 and ψ is in V_1 are clear from the definitions. Now

$$\varphi(2x) = \begin{cases} 1 & \text{if } 0 \leq x < \frac{1}{2}, \\ 0 & \text{otherwise,} \end{cases}$$

and

$$\varphi(2x - 1) = \begin{cases} 1 & \text{if } \frac{1}{2} \leq x < 1, \\ 0 & \text{otherwise.} \end{cases}$$

Their sum is 1 for $0 \leq x < 1$ and thus equals $\varphi(x)$, while their difference is 1 for $0 \leq x < \frac{1}{2}$ and is -1 for $\frac{1}{2} \leq x < 1$ and thus equals $\psi(x)$. For inner products we have

$$(\varphi_{0,k}, \psi) = \int_{\mathbb{R}} \varphi(x - k)\psi(x) dx = \int_k^{k+1} \psi(x) dx,$$

and this is 0 for all k ; for $k = 0$, it is 0 because ψ has integral 0, and for $k \neq 0$, it is 0 because the set where ψ is not 0 does not meet $[k, k + 1)$. Thus ψ is orthogonal to every member of the orthonormal basis of V_0 given in Step 2. Since ψ is known to be in V_1 , ψ is in W_0 .

Step 7. We show that the functions $x \mapsto \psi(x - k)$ form an orthonormal basis of W_0 .

Being nonzero on disjoint sets, they are orthonormal. Let f be any member of W_0 . Since W_0 is contained in V_1 and since the functions $\varphi_{1,k}$ form an orthonormal

basis of V_1 , f is of the form

$$\begin{aligned}
f(x) &= \sum_k c_k \varphi_{1,k}(x) = \sum_{k \text{ even}} c_k \varphi_{1,k}(x) + \sum_{k \text{ odd}} c_k \varphi_{1,k}(x) \\
&= \sqrt{2} \sum_l c_{2l} \varphi(2x - 2l) + \sqrt{2} \sum_l c_{2l+1} \varphi(2x - 2l - 1) \\
&= \frac{\sqrt{2}}{2} \sum_l (c_{2l} + c_{2l+1}) (\varphi(2x - 2l) + \varphi(2x - 2l - 1)) \\
&\quad + \frac{\sqrt{2}}{2} \sum_l (c_{2l} - c_{2l+1}) (\varphi(2x - 2l) - \varphi(2x - 2l - 1)) \\
&= \frac{\sqrt{2}}{2} \sum_l (c_{2l} + c_{2l+1}) \varphi(x - l) + \frac{\sqrt{2}}{2} \sum_l (c_{2l} - c_{2l+1}) \psi(x - l),
\end{aligned}$$

the last equality holding by Step 6. Since f is orthogonal to V_0 , taking the inner product of both sides with any particular $\varphi(x - l)$ shows that the coefficient of $\varphi(x - l)$ is 0. That being true for all l , f is exhibited as in the closed linear span of the functions $\psi(x - l)$.

Step 8. We show that for each $j \geq 0$, the functions $\psi_{j,k}$, as k varies, form an orthonormal basis of W_j .

In fact, this is immediate from $(\dagger\dagger)$ and Step 7.

Step 9. The functions $\varphi_{0,k}$ for $k \in \mathbb{Z}$ and the functions $\psi_{j,k}$ for $j \geq 0$ and $k \in \mathbb{Z}$ together form an orthonormal basis of $L^2(\mathbb{R})$. Here the $\varphi_{0,k}$ form an orthonormal basis of V_0 , and the other functions form an orthonormal basis of the orthogonal complement of V_0 in $L^2(\mathbb{R})$.

The functions $\varphi_{0,k}$ for $k \in \mathbb{Z}$ and the functions $\psi_{j,k}$ for $0 \leq j \leq n - 1$ and $k \in \mathbb{Z}$ together form an orthonormal basis of V_j , by (\ddagger) , Step 2, and Step 8. Taking the union on j of the nested spaces V_j and applying Step 4, we find that the functions $\varphi_{0,k}$ for $k \in \mathbb{Z}$ and the functions $\psi_{j,k}$ for $j \geq 0$ and $k \in \mathbb{Z}$ together form an orthonormal basis of $L^2(\mathbb{R})$.

Step 10. We extend the definitions of the spaces V_j and W_j to $j < 0$, and we observe that $(*)$, $(**)$, (\dagger) , $(\dagger\dagger)$ extend to be valid for all j , and (\ddagger) has a natural extension to handle the extended definitions.

The space V_j is the set of functions in $L^2(\mathbb{R})$ that are constant almost everywhere on each interval $[2^{-j}k, 2^{-j}(k + 1))$, and the space W_j is the orthogonal complement of V_j in V_{j+1} . Then it is immediate that $(*)$, $(**)$, (\dagger) , $(\dagger\dagger)$ extend to be valid for all j . The extended form of (\ddagger) is

$$V_n = V_m \perp (W_m \perp W_{m+1} \perp \cdots \perp W_{n-1}) \quad \text{for } m \leq n, \quad (\ddagger\ddagger)$$

and this too is immediate.

Step 11. The functions $\varphi_{m,k}$ for $k \in \mathbb{Z}$ and the functions $\psi_{j,k}$ for $j \geq m$ and $k \in \mathbb{Z}$ together form an orthonormal basis of $L^2(\mathbb{R})$.

This is immediate from Step 9, the extended Step 8, and $(\ddagger\ddagger)$.

Step 12. We prove that $\bigcap_{j=-\infty}^n V_j = 0$ for every integer n .

In fact, let f be a member of $\bigcap_{j=-\infty}^n V_j$. Being in each V_j , f is constant almost everywhere on each interval $[2^{-j}k, 2^{-j}(k+1))$ for $j \leq n$ and $k \in \mathbb{Z}$, say equal to $c_{j,k}$. If $E_{k,j}$ denotes the exceptional subset of $[2^{-j}k, 2^{-j}(k+1))$ of measure 0 where $f(x) \neq c_{j,k}$ and if $E = \bigcup_{j,k} E_{k,j}$, then E is a set of measure 0 and has the following property. For any $x \notin E$, f is constantly equal to $c_{j,k}$ on all intervals $[2^{-j}k, 2^{-j}(k+1))$ containing x . Fix $x_0 \notin E$. We can choose an increasing sequence of intervals $[2^{-j}k, 2^{-j}(k+1))$ containing x_0 and having union \mathbb{R} . The constants $c_{j,k}$ for the members of this sequence must match the value $f(x_0)$, and it follows that f is constantly equal to $f(x_0)$ almost everywhere. Since the only constant function in $L^2(\mathbb{R})$ is 0, we conclude that $\bigcap_{j=-\infty}^n V_j = 0$.

Step 13. The functions $\psi_{j,k}$ for $j \in \mathbb{Z}$ and $k \in \mathbb{Z}$ together form an orthonormal basis of $L^2(\mathbb{R})$.

From $(\ddagger\ddagger)$ and Step 12 it follows that V_0 is the orthogonal direct sum of the spaces $W_{-1}, W_{-2}, W_{-3}, \dots$. From Step 9 it then follows that $L^2(\mathbb{R})$ is the orthogonal direct sum of the spaces W_j for $j \in \mathbb{Z}$. By Step 8 the functions $\psi_{j,k}$ for $j \in \mathbb{Z}$ and $k \in \mathbb{Z}$ together form an orthonormal basis of $L^2(\mathbb{R})$. \square

As was mentioned in Section 1, corresponding to any wavelet ψ is the wavelet expansion

$$f(x) = \sum_{j,k \in \mathbb{Z}} \left(\int_{\mathbb{R}} f(y) \overline{\psi_{j,k}(y)} dy \right) \psi_{j,k}(x),$$

the series being understood as convergent in $L^2(\mathbb{R})$. This remark applies in particular to the Haar wavelet $\psi(x)$, and the resulting series is called the two-sided **Haar series expansion** of the function f . In a Haar series the complex conjugate sign can be dropped because ψ is real-valued, but we shall include it anyway.

When writing down an expansion in Haar series, however, there is some advantage in taking into account aspects of the proof of Theorem 10.4. The proof was organized around a certain increasing sequence of closed subspaces V_j whose union is dense in $L^2(\mathbb{R})$. Let us see how these spaces include finer and finer detail about f . The way in which the functions $\varphi_{j,k}$ and $\psi_{j,k}$ are defined involves evaluating φ or ψ at $2^j x - k$. It is helpful of this operation as one of *magnification*, affecting the *resolution* of what we can see. Namely it is helpful to think of the operation of passing from x to $2^j x$ as one of magnifying a graph by 2^j or of introducing better resolution so that details at the level of 2^{-j} become visible.

Let us be more specific. Step 9 observed that the functions $\varphi_{0,k}$ for $k \in \mathbb{Z}$ and the functions $\psi_{j,k}$ for $j \geq 0$ and $k \in \mathbb{Z}$ together form an orthonormal basis of $L^2(\mathbb{R})$. The corresponding expansion is

$$f(x) = \sum_{k \in \mathbb{Z}} \left(\int_{\mathbb{R}} f(y) \overline{\varphi_{0,k}(y)} dy \right) \varphi_{0,k}(x) + \sum_{j=0}^{\infty} \sum_{k \in \mathbb{Z}} \left(\int_{\mathbb{R}} f(y) \overline{\psi_{j,k}(y)} dy \right) \psi_{j,k}(x)$$

and is called a one-sided **Haar series expansion** of the function f . The first term represents the orthogonal projection of f on V_0 , and the second term represents the orthogonal projection on the orthogonal complement of V_0 .

This one-sided expansion is better than the two-sided expansion at emphasizing that the large positive values of j correspond to what is happening as one passes to the limit.

Step 11 of the proof gives another way of thinking about this process. It says that for any m (think of m as ≥ 0), the functions $\varphi_{m,k}$ and the functions $\psi_{j,k}$ with $j \geq m$ together form an orthonormal basis of $L^2(\mathbb{R})$. Comparing the resulting expansion of f with the display above, we see that $\sum_{k \in \mathbb{Z}} \left(\int_{\mathbb{R}} f(y) \overline{\varphi_{m,k}(y)} dy \right) \varphi_{m,k}(x)$ represents a partial sum of the one-sided Haar series expansion. It is in fact the orthogonal projection of f on the subspace V_m . Thus we can think of the orthogonal projection on V_0 as giving a zeroth approximation to f . Then we add the terms $\sum_{k \in \mathbb{Z}} \left(\int_{\mathbb{R}} f(y) \overline{\psi_{0,k}(y)} dy \right) \psi_{0,k}(x)$ and obtain the first approximation to f , namely the orthogonal projection on V_1 . We continue by adding the terms $\sum_{k \in \mathbb{Z}} \left(\int_{\mathbb{R}} f(y) \overline{\psi_{1,k}(y)} dy \right) \psi_{1,k}(x)$ and obtain the second approximation to f , namely the orthogonal projection on V_2 . With each step we improve the resolution, obtaining a better approximation to f . The limit of the approximations, taken in the L^2 sense, is f .

The process thus consists in looking at f with an infinite system of finer and finer resolutions. It is for this reason that the term “multiresolution analysis” will be used for this construction starting in the next section.

Notice that what is happening here is quite different from the situation with Fourier series. With Fourier series a new term in a series represents taking into account a new frequency, an enlargement of the frequency domain. With wavelets a new term represents taking into account a higher resolution, thus giving better knowledge of what is happening in the time domain.

Some readers may be helped by a piece of intuition used by people in signal analysis. They think of the scaling function φ as being akin to a low-pass filter and the mother wavelet ψ as being akin to a high-pass filter. It is helpful to think of these filters as working on fineness of detail, however, rather than frequencies. For

example, in the construction in Theorem 10.4, φ and its integer translates together yielded the orthogonal projection on the fundamental space V_0 , while ψ and its integer translates yielded the orthogonal projection on the detail space consisting of the orthogonal complement of V_0 in V_1 . As Barbara Hubbard explains in her book,⁶ it was this piece of intuition that finally brought mathematicians and engineers together on the subject of wavelets in 1986.

We conclude this section with a brief discussion of spaces of functions other than L^2 on the real line. We shall return to L^2 from the beginning of the next section. This discussion will enable us to make some comparisons of Haar series and Fourier series. The results with Haar series that we mention are just the beginning. Considerable research has gone into the study of Haar series and other wavelet expansions in connection with spaces other than L^2 , but we shall not be delving into it beyond the few remarks that we include here.

To begin with, for any complex-valued function f on \mathbb{R} satisfying suitable conditions, we define

$$(P_m f)(x) = \sum_{k \in \mathbb{Z}} \left(\int_{\mathbb{R}} f(y) \overline{\varphi_{m,k}(y)} dy \right) \varphi_{m,k}(x).$$

If we are working with L^2 functions, the operator P_m is the orthogonal projection of $L^2(\mathbb{R})$ on V_m . But our interest now will be in other spaces of functions.

The function $\varphi_{m,k}(x)$ is nonzero if and only if $k \leq 2^m x < k+1$. Consequently for fixed m and x , there is exactly one value of k for which $\varphi_{m,k}(x)$ is nonzero. Thus the sum defining $(P_m f)(x)$ has only one term. Also the function $\overline{\varphi_{m,k}(y)}$ has compact support, and thus the integral $\int_{\mathbb{R}} f(y) \overline{\varphi_{m,k}(y)} dy$ is well defined as soon as f is a measurable function on \mathbb{R} that is locally integrable, i.e., integrable on each compact set. Consequently the expression defining $(P_m f)(x)$ is well defined whenever the function f on \mathbb{R} is locally integrable. Its value is just $2^m \int_{k \leq 2^m y < k+1} f(y) dy$, where k is the unique integer such that $k \leq 2^m x < k+1$. It is a simple matter to use Step 5 and its dilates in Theorem 10.4 to see that

$$(P_{m+1} f)(x) - (P_m f)(x) = \sum_{k \in \mathbb{Z}} \left(\int_{\mathbb{R}} f(y) \overline{\psi_{m,k}(y)} dy \right) \psi_{m,k}(x).$$

Therefore convergence results about $P_m f$ as m tends to $+\infty$ are in effect convergence results about the one-sided Haar series expansion of f . We summarize as follows.

⁶*The World According to Wavelets*, listed in the Selected References.

Proposition 10.5. If f is a locally integrable complex-valued function on \mathbb{R} and if k is the unique integer such that $k \leq 2^m x < k + 1$, then the partial sum $(P_m f)(x)$ of the one-sided Haar series expansion is well defined and is given by

$$|I_{m,k}|^{-1} \int_{I_{m,k}} f(y) dy,$$

where $I_{m,k} = \{y \in \mathbb{R} \mid k \leq 2^m y < k + 1\}$ and $|I_{m,k}|$ is its measure, namely 2^{-m} .

The expression for $(P_m f)(x)$ in Lemma 10.5 is the one that arises in the theory of differentiation of integrals, which is discussed in Section VI.6 of *Basic*. Application of the results of that section immediately yields the following corollary.

Corollary 10.6. If f is a locally integrable complex-valued function on \mathbb{R} , then the one-sided Haar series of f converges to f almost everywhere.

If f is continuous, the situation is much simpler, since we no longer need the results of Section VI.6 of *Basic*.

Corollary 10.7. If f is a continuous complex-valued function on \mathbb{R} , then the one-sided Haar series of f converges to f pointwise. The convergence is uniform on any set on which f is uniformly continuous.

REMARK. Observe that this behavior is much better than what happens for Fourier series: the Fourier series of a continuous function can diverge at a point.

PROOF. For $x \in I_{m,k}$, we have

$$\begin{aligned} \left| |I_{m,k}|^{-1} \int_{I_{m,k}} f(y) dy - f(x) \right| &= |I_{m,k}|^{-1} \left| \int_{I_{m,k}} (f(y) - f(x)) dy \right| \\ &\leq |I_{m,k}|^{-1} \int_{I_{m,k}} |f(y) - f(x)| dy. \quad (*) \end{aligned}$$

Let $\epsilon > 0$ be given, and choose the corresponding δ of uniform continuity on E . If m is large enough so that $2^{-m} < \delta$, then $|y - x| \leq \delta$ whenever x and y are both in $I_{m,k}$, and hence $|f(y) - f(x)| \leq \epsilon$. Consequently (*) is $\leq \epsilon$. \square

Next we show that one-sided Haar series do not exhibit Gibbs phenomenon in the way that Proposition 9.2 says that Fourier series do.

Lemma 10.8. If f is a bounded locally integrable function of \mathbb{R} and if x in \mathbb{R} , then $|(P_m f)(x)| \leq \|f\|_{\text{sup}}$.

PROOF. Choose k so that $k \leq 2^m x < k + 1$. Then

$$|(P_m f)(x)| = 2^m \left| \int_{k \leq 2^m y < k+1} f(y) dy \right| \leq 2^m \|f\|_{\text{sup}} \int_{k \leq 2^m y < k+1} dy = \|f\|_{\text{sup}}.$$

\square

Proposition 10.9. Suppose that f is a real-valued function on \mathbb{R} that is continuous everywhere except at the one point x_0 , where f has a jump discontinuity. Then the one-side Haar series of f does not exhibit Gibbs phenomenon. Specifically if $\lim_{x \uparrow x_0} f(x) < \lim_{x \downarrow x_0} f(x)$, then along every sequence $\{x_n\}$ decreasing to x_0 and sequence m_n tending to $+\infty$, the inequality

$$\limsup_{n \rightarrow \infty} (P_{m_n} f)(x_n) \leq \lim_{x \downarrow x_0} f(x)$$

holds.

PROOF. Let $J = \lim_{x \downarrow x_0} f(x) - \lim_{x \uparrow x_0} f(x)$ be the size of the jump discontinuity of f at x_0 . The value of f at x_0 itself does not affect the Haar series of f , and we may therefore redefine $f(x_0)$ to equal $\lim_{x \uparrow x_0} f(x)$.

Let $g(x)$ be the function that equals 0 for $x \leq x_0$, equals $x_0 + 1 - x$ for $x_0 < x \leq x_0 + 1$, and equals 0 for $x \geq x_0 + 1$. This is continuous except at x_0 , where it has a jump discontinuity of 1. By Lemma 10.8,

$$|(P_m g)(x_n)| \leq \|g\|_{\text{sup}} = 1 \quad \text{for every } m \text{ and } n. \quad (*)$$

Write $f = (f - Jg) + Jg$. The function $f - Jg$ is continuous everywhere, and $(P_m(f - Jg))(x)$ tends to $(f - Jg)(x)$ uniformly for x in a neighborhood of x_0 , by Corollary 10.7. Proposition 1.16 of *Basic* therefore shows that

$$\lim_{n \rightarrow \infty} (P_{m_n}(f - Jg))(x_n) = (f - Jg)(x_0) = \lim_{x \downarrow x_0} (f - Jg)(x). \quad (**)$$

The proposition follows by adding the equality (**) and J times the inequality (*). \square

Thus there are senses in which one-sided Haar series are much better behaved than Fourier series. But there are other senses in which Fourier series are the better behaved. One of these is that the existence of derivatives of a function in the subject of Fourier series forces the Fourier coefficients to have at least a certain rate of decrease. The relevant estimate comes from using integration by parts in the formula for the n^{th} Fourier coefficient. Any attempt to imitate this argument for Haar series is doomed because the functions φ and ψ are not even continuous. Consequently a Haar series cannot be expected to have a very small remainder term if terms are discarded from the series. This feature is a drawback of Haar series and is a reason to search for other wavelets for which the series expansions of smooth functions are rapidly convergent.

3. Multiresolution Analysis

In this section we isolate the essential features of the construction of the Haar system in Section 2 and arrive at a construction of wavelets that applies in many situations. A **multiresolution analysis** consists of an increasing system $\{V_j\}_{j=-\infty}^{\infty}$ of closed vector subspaces of $L^2(\mathbb{R})$ and a function φ in $L^2(\mathbb{R})$ such that

- (i) $\bigcup_j V_j$ is dense in $L^2(\mathbb{R})$,
- (ii) $\bigcap_j V_j = 0$,
- (iii) for each $j \in \mathbb{Z}$, $x \mapsto f(x)$ is in V_j if and only if $x \mapsto f(2x)$ is in V_{j+1} , and
- (iv) the system of functions $\{x \mapsto \varphi(x - k)\}_{k \in \mathbb{Z}}$ is an orthonormal basis of V_0 .

The reason for the cumbersome term “multiresolution analysis” was explained in Section 2 after the definition of one-sided Haar series expansion. The function φ is called the **scaling function** of the multiresolution analysis.

For each integer j , we define functions $\varphi_{j,k}$ in $L^2(\mathbb{R})$ for $k \in \mathbb{Z}$ by

$$\varphi_{j,k}(x) = 2^{j/2} \varphi(2^j x - k).$$

That is all that is needed. The function ψ has not been mentioned!

The main result of the section will be that the existence ψ is built into the definition of multiresolution analysis, and there is little choice for ψ . Before stating such a result as a theorem, let us go through the steps of the proof of Theorem 10.4 to see how much has been captured by this definition in the case of the Haar system.

Indeed, for the Haar system we defined the scaling function φ at the outset, and we defined closed subspaces V_j of $L^2(\mathbb{R})$ in Steps 2, 3, and 10 of the proof of Theorem 10.4. Step 4 established (i) above, Step 12 established (ii), (**), within Steps 3 and 10 established (iii), and Step 2 established (iv). Therefore the Haar system is a multiresolution analysis.

The proof of Theorem 10.4 established some additional properties of the Haar multiresolution analysis. Line (†) of Step 3 observed the functions $\varphi_{j,k}$ form an orthonormal basis of V_j for $j \geq 0$, and (†) in Step 10 said that the same thing is true for $j < 0$. Finally Step 6 established the all-important equation

$$\varphi(x) = \varphi(2x) + \varphi(2x - 1)$$

in the Haar case. All the other intermediate conclusions in the proof of Theorem 10.4 related to ψ .

To construct ψ , we make use of the analog of the above equation for a general multiresolution analysis. For the general case φ is in V_0 , which is contained in V_1 ,

and the functions $\varphi_{1,k}$ form an orthonormal basis of V_1 . Expansion of φ in this orthonormal basis leads us to a series $\varphi = \sum_{k=-\infty}^{\infty} a_k \varphi_{1,k}$ convergent in $L^2(\mathbb{R})$. In this expansion the coefficients are inner products $a_k = (\varphi, \varphi_{1,k})$ satisfying $\sum |a_k|^2 = \|\varphi\|_2^2 = 1$. Substituting the definition of $\varphi_{1,k}$ allows us to rewrite this expansion as

$$\varphi(x) = \sum_{k=-\infty}^{\infty} a_k \sqrt{2} \varphi(2x - k).$$

We call this result the **scaling equation**⁷ of the multiresolution analysis. We study the scaling equation through its Fourier transform.

Associated to the scaling equation is a useful L^2 periodic function m_0 of period 1 that behaves like a generating function. Namely the Riesz–Fischer Theorem (Theorem 6.51 of *Basic*) shows that there exists a periodic L^2 function m_0 of period 1 such that m_0 is given on $[0, 1]$ by a Fourier series⁸ as

$$m_0(y) = \frac{1}{\sqrt{2}} \sum_{k=-\infty}^{\infty} a_k e^{-2\pi iky}.$$

This function has

$$\|m_0\|_{L^2([0,1])}^2 = \frac{1}{2} \sum_{k=-\infty}^{\infty} |a_k|^2 = \frac{1}{2}.$$

The Fourier transform of the scaling equation is

$$(\mathcal{F}\varphi)(y) = \sum_{k=-\infty}^{\infty} \frac{1}{\sqrt{2}} a_k e^{-\pi iky} (\mathcal{F}\varphi)\left(\frac{1}{2}y\right).$$

By inspection the generating function m_0 allows us to write the Fourier transform of the scaling equation in the tidy form

$$\boxed{(\mathcal{F}\varphi)(y) = m_0(y/2)(\mathcal{F}\varphi)(y/2)}$$

If there is a wavelet ψ corresponding to the multiresolution analysis consisting of $\{V_j\}_{j=-\infty}^{\infty}$ and φ , then it lies in the orthogonal complement W_0 of V_0 in V_1 , and the functions $x \mapsto \psi(x - k)$ form an orthonormal basis of W_0 . The main result of this section is that all members of W_0 have a certain elegant form, and it shows which functions of that form can be taken as the desired wavelet ψ . Often we shall use a particular choice of this function as the desired wavelet, as we remark after the statement of the theorem.

⁷Some authors treat the factors of $\sqrt{2}$ in a different way, incorporating them into the coefficients. Some authors call this the dilation equation; other authors do not give it a name.

⁸Strictly speaking, this is the Fourier series of $m_0(-y)$ rather than $m_0(y)$, but we follow the convention used in the book by Daubechies and echoed in the book by Pinsky. Regardless of how authors handle the factors of $\sqrt{2}$, the factors have disappeared by the time that one computes the values of $m_0(y)$.

Theorem 10.10. Let $\{V_j\}_{j=-\infty}^{\infty}$ and φ constitute a multiresolution analysis, and let m_0 be the generating function of the scaling equation. Then

- (a) the most general member f of the orthogonal complement W_0 of V_0 in V_1 has Fourier transform of the form

$$(\mathcal{F}f)(y) = e^{\pi iy} \nu(y) \overline{m_0(\frac{1}{2}y + \frac{1}{2})} (\mathcal{F}\varphi)(\frac{1}{2}y),$$

where ν is a periodic function of period 1 and with $\|\nu\|_{L^2([0,1])}^2 = \|f\|_2^2$, and

- (b) a member f of W_0 as in (a) will serve as a wavelet for the multiresolution analysis if and only if $|\nu(y)| = 1$ almost everywhere.

The proof will be preceded by some discussion and three lemmas. Once we have settled on a particular choice of wavelet ψ from Theorem 10.10, we can write down a **wavelet equation** analogous to the scaling equation. The reason is that ψ is in V_1 and the functions $\varphi_{1,k}$ form an orthonormal basis of V_1 . Expansion of ψ in this orthonormal basis leads us to a series $\psi = \sum_{k=-\infty}^{\infty} b_k \varphi_{1,k}$ convergent in $L^2(\mathbb{R})$. In this expansion the coefficients are inner products $b_k = (\psi, \varphi_{1,k})$ satisfying $\sum |b_k|^2 = \|\psi\|_2^2 = 1$. Substituting the definition of $\varphi_{1,k}$ allows us to rewrite this wavelet equation as

$$\psi(x) = \sum_{k=-\infty}^{\infty} b_k \sqrt{2} \varphi(2x - k).$$

We argue with this equation just as we did with the scaling equation. Associated to the wavelet equation is a useful L^2 periodic function m_1 of period 1 that behaves like a generating function. Namely there exists a periodic L^2 function m_1 of period 1 such that m_1 is given on $[0, 1]$ by a Fourier series as

$$m_1(y) = \frac{1}{\sqrt{2}} \sum_{k=-\infty}^{\infty} b_k e^{-2\pi iky}.$$

This function has

$$\|m_1\|_{L^2([0,1])}^2 = \frac{1}{2} \sum_{k=-\infty}^{\infty} |b_k|^2 = \frac{1}{2}.$$

The Fourier transform of the wavelet equation is

$$(\mathcal{F}\psi)(y) = \sum_{k=-\infty}^{\infty} \frac{1}{\sqrt{2}} b_k e^{-\pi iky} (\mathcal{F}\varphi)(\frac{1}{2}y),$$

and the generating function m_1 allows us to write the Fourier transform of the wavelet equation in the tidy form

$$(\mathcal{F}\psi)(y) = m_1(y/2) (\mathcal{F}\varphi)(y/2).$$

EXAMPLE. In the case of the Haar system, Step 6 of the proof of Theorem 10.4 shows that the scaling equation and the wavelet equation are

$$\begin{aligned}\varphi(x) &= \varphi(2x) + \varphi(2x - 1) \\ \psi(x) &= \varphi(2x) - \varphi(2x - 1).\end{aligned}$$

In other words, $a_0 = 1/\sqrt{2}$ and $a_1 = 1/\sqrt{2}$, while $b_0 = 1/\sqrt{2}$ and $b_1 = -1/\sqrt{2}$. The functions m_0 and m_1 are given by

$$\begin{aligned}m_0(y) &= \frac{1}{2}(1 + e^{-2\pi iy}) \\ m_1(y) &= \frac{1}{2}(1 - e^{-2\pi iy}),\end{aligned}$$

and we have

$$m_1(y) = e^{2\pi iy} \overline{(-e^{-4\pi iy}) m_0(y + \frac{1}{2})}.$$

Let us return to the specific choice of a wavelet in the general case. According to Theorem 10.10, we are to specify an L^2 function $v(y)$ of period 1 with $|v(y)| = 1$ almost everywhere, and then the formula for m_1 in terms of m_0 (after replacement of $y/2$ by y) will be

$$m_1(y) = e^{2\pi iy} \overline{v(y) m_0(y + \frac{1}{2})}.$$

The seemingly natural choice is to take $v(y) = 1$, and we shall make that choice for a while in the proof of Theorem 10.10b, obtaining

$$m_1(y) = e^{2\pi iy} \overline{m_0(y + \frac{1}{2})}.$$

That choice leads in the general case to the formula

$$b_k = (-1)^{k+1} \overline{a_{-k-1}}$$

for the coefficients of the wavelet equation.

The example of the Haar system shows that other choices for v will sometimes be appropriate; for it the choice $v(y) = -e^{-4\pi iy}$ was what produced the Haar wavelet from the Haar scaling function. The choice $v(y) = -e^{-4\pi iy}$ leads to the formulas

$$m_1(y) = -e^{-2\pi iy} \overline{m_0(y + \frac{1}{2})}$$

and

$$b_k = (-1)^k \overline{a_{-k+1}}.$$

As a general matter, taking $v(y)$ to be the product of a power of $e^{2\pi iy}$ and a constant of absolute value one has the effect of moving the wavelet left or right so that it looks better. This will be especially convenient later for the Daubechies wavelets, which are of compact support. Problem 3 at the end of the chapter shows that the only valid choices of $v(y)$ in the case of compact support are the products of a power of $e^{2\pi iy}$ and a constant of absolute value one.

Now we come to the three lemmas. The first and the third will be used in the course of proving Theorem 10.10. The second lemma will not be used until Section 7, but the techniques for its proof take some of the mystery out of the proof of Theorem 10.10.

Lemma 10.11. If $h(x)$ is a function in $L^2(\mathbb{R})$, then the set of functions $\{h(x - k)\}_{k=-\infty}^{\infty}$ is orthonormal if and only if

$$\sum_{l=-\infty}^{\infty} |(\mathcal{F}h)(y + l)|^2 = 1$$

almost everywhere.

PROOF. By the Plancherel Theorem (Section VIII.3 of *Basic*) we have

$$\begin{aligned} \delta_{0k} &\stackrel{?}{=} \int_{\mathbb{R}} h(x) \overline{h(x - k)} dx \\ &= \int_{\mathbb{R}} (\mathcal{F}h)(y) e^{-2\pi iky} \overline{(\mathcal{F}h)(y)} dy \\ &= \int_{\mathbb{R}} e^{2\pi iky} |(\mathcal{F}h)(y)|^2 dy \\ &= \sum_{l=-\infty}^{\infty} \int_l^{l+1} e^{2\pi iky} |(\mathcal{F}h)(y)|^2 dy \\ &= \sum_{l=-\infty}^{\infty} \int_0^1 e^{2\pi ik(y'+l)} |(\mathcal{F}h)(y' + l)|^2 dy' \\ &= \sum_{l=-\infty}^{\infty} \int_0^1 e^{2\pi iky'} |(\mathcal{F}h)(y' + l)|^2 dy'. \end{aligned} \quad (*)$$

If we were to insert absolute value signs in the integrand of (*), we would obtain the result $\int_{\mathbb{R}} |(\mathcal{F}h)(y')|^2 dy' = \int_{\mathbb{R}} |h(x)|^2 dx$ by the Plancherel formula (Theorem 8.6 of *Basic*), and this is finite. Therefore Fubini's Theorem allows us to interchange sum and integral in (*). Doing the interchange and changing y' back to y , results in the equation

$$\delta_{0k} \stackrel{?}{=} \int_0^1 e^{2\pi iky} \left(\sum_{l=-\infty}^{\infty} |(\mathcal{F}h)(y + l)|^2 \right) dy. \quad (**)$$

This says that the system is orthonormal if and only if the function in $L^1([0, 1])$ given by the almost everywhere convergent series $\sum_{l=-\infty}^{\infty} |(\mathcal{F}h)(y+l)|^2$ has the same Fourier coefficients as the constant function 1. By the uniqueness theorem for Fourier series (Corollary 6.50 of *Basic*), we obtain the result that the system is orthonormal if and only if

$$\sum_{l=-\infty}^{\infty} |(\mathcal{F}h)(y+l)|^2 = 1 \quad \text{almost everywhere.} \quad \square$$

Lemma 10.12. Suppose $\varphi(x)$ is a function in $L^2(\mathbb{R})$ such that the set of functions $\{\varphi_{0,k}\}_{k=-\infty}^{\infty} = \{x \mapsto \varphi(x-k)\}_{k=-\infty}^{\infty}$ is orthonormal, and let V be the closure of the linear span of this set of functions. Let ℓ^2 be the set of square integrable doubly infinite sequences $\{c_k\}_{k=-\infty}^{\infty}$, and write $\delta_{\cdot,k}$ for the member of ℓ^2 that is 1 at k and is 0 otherwise. Parseval's Theorem produces unitary⁹ mappings $\alpha : \ell^2 \rightarrow V$ and $\beta : L^2([0, 1]) \rightarrow \ell^2$ such that $\alpha(\delta_{\cdot,k}) = \varphi_{0,k}$ and $\beta(e^{-2\pi iky}) = \delta_{\cdot,k}$. Regard members of $L^2([0, 1])$ as extended periodically to all of \mathbb{R} with period 1. Then for every $f \in V$,

- (a) the product of $(\beta^{-1}\alpha^{-1})(f)$ and $\mathcal{F}\varphi$ equals $\mathcal{F}f$, and
- (b) $\|(\beta^{-1}\alpha^{-1})(f)\|_{L^2([0,1])} = \|(\beta^{-1}\alpha^{-1})(f) \cdot (\mathcal{F}\varphi)\|_{L^2(\mathbb{R})}$.

PROOF. In the statement of the lemma, the unitary property of α follows from the assumption that $\{\varphi_{0,k}\}$ is an orthonormal basis of V and from the abstract Parseval Theorem for Hilbert spaces. The unitary property of β follows from the Parseval Theorem for Fourier series and the Riesz–Fischer Theorem.

In (a) the mapping $\beta^{-1}\alpha^{-1}$ acts on V by $\beta^{-1}\alpha^{-1}(\sum_k c_k \varphi_{0,k}) = \sum_k c_k e^{-2\pi iky}$, the convergence of the sum on the left being in $V \subseteq L^2(\mathbb{R})$ and the convergence of the sum on the right being in $L^2([0, 1])$. Since $\mathcal{F}\varphi_{0,k} = e^{-2\pi iky}(\mathcal{F}\varphi)(y) = \beta^{-1}\alpha^{-1}(\varphi_{0,k})(\mathcal{F}\varphi)(y)$, we immediately obtain $\mathcal{F}f = (\beta^{-1}\alpha^{-1})(f) \cdot \mathcal{F}\varphi$ for all members f of the vector-space linear span of $\{\varphi_{0,k}\}$. Also if $f_n \rightarrow f$ in $L^2(\mathbb{R})$, we know that $(\beta^{-1}\alpha^{-1})(f_n) \rightarrow (\beta^{-1}\alpha^{-1})(f)$ in $L^2([0, 1])$. This proves (a).

For the norm equality of (b), let us abbreviate $(\beta^{-1}\alpha^{-1}f)(y)$ as $\mu(y)$. Then

$$\begin{aligned} \int_{\mathbb{R}} |\mu(y)(\mathcal{F}\varphi)(y)|^2 dy &= \sum_{k=-\infty}^{\infty} \int_k^{k+1} |\mu(y)|^2 |(\mathcal{F}\varphi)(y)|^2 dy \\ &= \sum_{k=-\infty}^{\infty} \int_0^1 |\mu(y-k)|^2 |(\mathcal{F}\varphi)(y-k)|^2 dy \\ &= \sum_{k=-\infty}^{\infty} \int_0^1 |\mu(y)|^2 |(\mathcal{F}\varphi)(y-k)|^2 dy \quad \text{by periodicity} \end{aligned}$$

⁹“Unitary” means linear, norm-preserving, and onto.

$$\begin{aligned}
&= \int_0^1 |\mu(y)|^2 \sum_{k=-\infty}^{\infty} |(\mathcal{F}\varphi)(y-k)|^2 dy \\
&= \int_0^1 |\mu(y)|^2 dy \qquad \text{by Lemma 10.11.}
\end{aligned}$$

□

Lemma 10.13. If a multiresolution analysis is given with scaling function φ , then the generating function m_0 of the scaling equation satisfies the identity

$$|m_0(y)|^2 + |m_0(y + \frac{1}{2})|^2 = 1 \quad \text{almost everywhere.}$$

REMARKS. This lemma gives a sense in which the generating functions $m_0(y)$ and $m_1(y)$ are complementary. The method of proof will be used several times in what follows.

PROOF. We apply Lemma 10.11 with $h = \varphi$. Substituting for $(\mathcal{F}\varphi)(y+l)$ its value from the Fourier transform of the scaling equation rewrites this equality as

$$\sum_{l=-\infty}^{\infty} |m_0(\frac{1}{2}y + \frac{1}{2}l)|^2 |(\mathcal{F}\varphi)(\frac{1}{2}y + \frac{1}{2}l)|^2 = 1 \quad \text{a.e.}$$

Replacing $y/2$ by y in this relation shows that almost everywhere

$$\sum_{l=-\infty}^{\infty} |m_0(y + \frac{1}{2}l)|^2 |(\mathcal{F}\varphi)(y + \frac{1}{2}l)|^2 = 1.$$

We separate the even-numbered terms on the left from the odd-numbered terms and use that m_0 is periodic of period 1 to see that

$$\begin{aligned}
1 &= \sum_{l \text{ even}} |m_0(y + \frac{1}{2}l)|^2 |(\mathcal{F}\varphi)(y + \frac{1}{2}l)|^2 + \sum_{l \text{ odd}} |m_0(y + \frac{1}{2}l)|^2 |(\mathcal{F}\varphi)(y + \frac{1}{2}l)|^2 \\
&= |m_0(y)|^2 \sum_{l \text{ even}} |(\mathcal{F}\varphi)(y + \frac{1}{2}l)|^2 + |m_0(y + \frac{1}{2})|^2 \sum_{l \text{ odd}} |(\mathcal{F}\varphi)(y + \frac{1}{2}l)|^2 \\
&= |m_0(y)|^2 \sum_{l=-\infty}^{\infty} |(\mathcal{F}\varphi)(y+l)|^2 + |m_0(y + \frac{1}{2})|^2 \sum_{l=-\infty}^{\infty} |(\mathcal{F}\varphi)(y+l + \frac{1}{2})|^2 \\
&= |m_0(y)|^2 + |m_0(y + \frac{1}{2})|^2 \quad \text{almost everywhere,}
\end{aligned}$$

the last step holding by two applications of Lemma 10.11. □

PROOF OF THEOREM 10.10a. Let f be an arbitrary member of the orthogonal complement W_0 of V_0 in V_1 . Since the functions $\varphi_{1,k}$ form an orthonormal basis of V_1 , we can expand f in this orthonormal basis and obtain a series $f = \sum_{k=-\infty}^{\infty} f_k \varphi_{1,k}$ convergent in $L^2(\mathbb{R})$. In this expansion the coefficients are inner products $f_k = (f, \varphi_{1,k})$ satisfying $\sum_k |f_k|^2 = \|f\|_2^2$. Substituting the definition of $\varphi_{1,k}$ allows us to rewrite this expansion as

$$f(x) = \sum_{k=-\infty}^{\infty} f_k \sqrt{2} \varphi(2x - k).$$

Arguing as with φ and the scaling equation, we obtain

$$(\mathcal{F}f)(y) = \sum_{k=-\infty}^{\infty} \frac{1}{\sqrt{2}} f_k e^{-\pi i k y} (\mathcal{F}\varphi)\left(\frac{1}{2}y\right) = m_f(y/2) (\mathcal{F}\varphi)(y/2), \quad (*)$$

where m_f is the function of period 1 given on $[0, 1]$ by its Fourier series as

$$m_f(y) = \frac{1}{\sqrt{2}} \sum_{k=-\infty}^{\infty} f_k e^{-2\pi i k y}.$$

This function satisfies

$$\|m_f\|_{L^2([0,1])}^2 = \frac{1}{2} \sum_{k=-\infty}^{\infty} |f_k|^2 = \frac{1}{2} \|f\|_2^2. \quad (**)$$

The condition that f is orthogonal to V_0 means that f is orthogonal to all $\varphi_{0,k}$. By the Plancherel Theorem (Theorem 8.6 of *Basic*) this is the condition that

$$0 = \int_{\mathbb{R}} (\mathcal{F}f)(y) \overline{e^{-2\pi i k y} (\mathcal{F}\varphi)(y)} dy \quad \text{for } k \in \mathbb{Z}.$$

Arguing as with (*) and (**) in the proof of Lemma 10.11, we can rewrite this condition as

$$0 = \int_0^1 e^{2\pi i k y} \left(\sum_{l=-\infty}^{\infty} (\mathcal{F}f)(y+l) \overline{(\mathcal{F}\varphi)(y+l)} \right) dy.$$

In other words, the function in $L^1([0, 1])$ given almost everywhere by the absolutely convergent series $\sum_{l=-\infty}^{\infty} (\mathcal{F}f)(y+l) \overline{(\mathcal{F}\varphi)(y+l)}$ has all Fourier coefficients 0. From the uniqueness theorem for Fourier series (Corollary 6.50 of *Basic*), we obtain the almost-everywhere equality

$$\sum_{l=-\infty}^{\infty} (\mathcal{F}f)(y+l) \overline{(\mathcal{F}\varphi)(y+l)} = 0.$$

Substituting for $(\mathcal{F}f)(y+l)$ and $(\mathcal{F}\varphi)(y+l)$ the values from (*) and the Fourier transform of the scaling equation allows us to rewrite this equality as

$$\sum_{l=-\infty}^{\infty} m_f(\frac{1}{2}y + \frac{1}{2}l) \overline{m_0(\frac{1}{2}y + \frac{1}{2}l)} (\mathcal{F}\varphi)(\frac{1}{2}y + \frac{1}{2}l) \overline{(\mathcal{F}\varphi)(\frac{1}{2}y + \frac{1}{2}l)} = 0.$$

Replacement of $y/2$ by y in this relation shows that almost everywhere

$$\sum_{l=-\infty}^{\infty} m_f(y + \frac{1}{2}l) \overline{m_0(y + \frac{1}{2}l)} |(\mathcal{F}\varphi)(y + \frac{1}{2}l)|^2 = 0.$$

Just as in the proof of Lemma 10.13, we separate the even-numbered terms in the sum from the odd-numbered terms and use that m_0 and m_f are periodic of period 1 to see that

$$m_f(y) \overline{m_0(y)} + m_f(y + \frac{1}{2}) \overline{m_0(y + \frac{1}{2})} = 0 \quad (\dagger)$$

almost everywhere.

For almost every y , at least one of $m_0(y)$ and $m_0(y + \frac{1}{2})$ is nonzero, according to Lemma 10.13. If y has the property that both $m_0(y)$ and $m_0(y + \frac{1}{2})$ are nonzero, then we can set

$$\lambda(y) = \frac{m_f(y)}{m_0(y + \frac{1}{2})} \quad \text{and} \quad \lambda(y + \frac{1}{2}) = \frac{m_f(y + \frac{1}{2})}{m_0(y)}, \quad (\dagger\dagger)$$

and we see from (\dagger) that

$$\lambda(y) + \lambda(y + \frac{1}{2}) = 0. \quad (\ddagger)$$

If $m_0(y) = 0$ and $m_0(y + \frac{1}{2}) \neq 0$, then we define $\lambda(y)$ by the first equation in (\dagger\dagger) and $\lambda(y + \frac{1}{2})$ by (\ddagger), while if $m_0(y) \neq 0$ and $m_0(y + \frac{1}{2}) = 0$, then we define $\lambda(y + \frac{1}{2})$ by the second equation in (\dagger\dagger) and $\lambda(y)$ by (\ddagger). The result is that we have a definition almost everywhere of a periodic function λ of period 1 such that (\ddagger) holds almost everywhere and such that

$$m_f(y) = \lambda(y) \overline{m_0(y + \frac{1}{2})} \quad (\ddagger\ddagger)$$

almost everywhere. This equation shows that

$$\begin{aligned} \|m_f\|_{L^2[0,1]}^2 &= \int_0^1 |\lambda(y)|^2 |m_0(y + \frac{1}{2})|^2 dy \\ &= \int_0^{1/2} |\lambda(y)|^2 |m_0(y + \frac{1}{2})|^2 dy + \int_{1/2}^1 |\lambda(y)|^2 |m_0(y + \frac{1}{2})|^2 dy \\ &= \int_0^{1/2} |\lambda(y)|^2 |m_0(y + \frac{1}{2})|^2 dy + \int_0^{1/2} |\lambda(y)|^2 |m_0(y)|^2 dy \quad \text{by } (\ddagger) \\ &= \int_0^{1/2} |\lambda(y)|^2 dy \quad \text{by Lemma 10.13.} \end{aligned} \quad (\S)$$

From (‡) it follows that $v(2y) = e^{-2\pi iy}\lambda(y)$ with $v(y)$ periodic of period 1. We substitute from (‡‡) into (*) and obtain

$$(\mathcal{F}f)(y) = m_f(\frac{1}{2}y)(\mathcal{F}\varphi)(\frac{1}{2}y) = \lambda(\frac{1}{2}y)\overline{m_0(\frac{1}{2}y + \frac{1}{2})}(\mathcal{F}\varphi)(\frac{1}{2}y).$$

Thus

$$(\mathcal{F}f)(y) = e^{\pi iy}v(y)\overline{m_0(\frac{1}{2}y + \frac{1}{2})}(\mathcal{F}\varphi)(\frac{1}{2}y),$$

as required.

Finally we have

$$\int_0^1 |v(y)|^2 dy = 2 \int_0^{1/2} |v(2y)|^2 dy = 2 \int_0^{1/2} |\lambda(y)|^2 dy = 2 \|m_f\|_{L^2[0,1]}^2 = \|f\|_2^2 \tag{§§}$$

by definition of v and use of (§) and (**). □

PROOF OF THEOREM 10.10b. Taking $v = 1$, we define ψ in $L^2(\mathbb{R})$ by

$$(\mathcal{F}\psi)(y) = e^{\pi iy}\overline{m_0(\frac{1}{2}y + \frac{1}{2})}(\mathcal{F}\varphi)(\frac{1}{2}y).$$

We prove that $\{\psi(y - k)\}_{k=-\infty}^\infty$ is an orthonormal basis of W_0 . To see that it is orthonormal, we use Lemma 10.11, breaking the sum for ψ into even-numbered and odd-numbered terms and applying Lemma 10.11 for φ in each of the terms. We have

$$\begin{aligned} \sum_l |\mathcal{F}\psi(y + l)|^2 &= \sum_l |m_0(\frac{1}{2}y + \frac{1}{2}l + \frac{1}{2})|^2 |\mathcal{F}\varphi(\frac{1}{2}y + \frac{1}{2}l)|^2 \\ &= |m_0(\frac{1}{2}y + \frac{1}{2})|^2 \sum_l |\mathcal{F}\varphi(\frac{1}{2}y + l)|^2 \\ &\quad + |m_0(\frac{1}{2}y)|^2 \sum_l |\mathcal{F}\varphi(\frac{1}{2}y + \frac{1}{2} + l)|^2 \\ &= |m_0(\frac{1}{2}y + \frac{1}{2})|^2 + |m_0(\frac{1}{2}y)|^2 \quad \text{a.e. by Lemma 10.11 for } \varphi \\ &= 1 \quad \text{a.e. by Lemma 10.13,} \end{aligned}$$

and thus Lemma 10.11 indeed allows us to conclude that $\{\psi(y - k)\}_{k=-\infty}^\infty$ is an orthonormal set.

To show completeness when $v = 1$, we are to show that any f in W_0 has an expansion in $L^2(\mathbb{R})$ as $f = \sum_k f_k \psi_{0,k}$. This is the question whether equality holds in Bessel's inequality $\|f\|_2^2 \geq \sum_k |f_k|^2$, the coefficient f_k being given by $f_k = \int_{\mathbb{R}} f(x)\overline{\psi(x - k)} dx$.

We know from (a) that any f in W_0 is of the form $(\mathcal{F}f)(y) = v(y)(\mathcal{F}\psi)(y)$ for a periodic function v of period 1 with $\|v\|_{L^2[0,1]}^2 = \|f\|_2^2$. By Parseval's equality

for $L^2[0, 1]$, we can write $v(x) = \sum_k c_k e^{-2\pi i k x}$ with $\sum_k |c_k|^2 = \|v\|_{L^2[0,1]}^2$, and (§§) has shown that $\|v\|_{L^2[0,1]}^2 = \|f\|_2^2$. Thus completeness will follow if we show that $f_k = c_k$ for all k .

The verification that $f_k = c_k$ is rather similar to the argument in Lemma 10.11. On the one hand, direct computation gives

$$\begin{aligned} f_k &= \int_{\mathbb{R}} f(x) \overline{\psi(x-k)} dx \\ &= \int_{\mathbb{R}} (\mathcal{F}f)(y) \overline{(\mathcal{F}\psi_{0,k})(y)} dy \\ &= \int_{\mathbb{R}} (\mathcal{F}f)(y) e^{-2\pi i k y} \overline{(\mathcal{F}\psi)(y)} dy \\ &= \int_{\mathbb{R}} v(y) e^{2\pi i k y} |(\mathcal{F}\psi)(y)|^2 dy \\ &= \sum_{l=-\infty}^{\infty} \int_l^{l+1} v(y) e^{2\pi i k y} |(\mathcal{F}\psi)(y)|^2 dy \\ &= \sum_{l=-\infty}^{\infty} \int_0^1 v(y) e^{2\pi i k y} |(\mathcal{F}\psi)(y+l)|^2 dy, \end{aligned}$$

and on the other hand, Lemma 10.11 gives

$$\begin{aligned} c_k &= \int_0^1 v(y) e^{2\pi i k y} dy \\ &= \int_0^1 \sum_{l=-\infty}^{\infty} v(y) e^{2\pi i k y} |(\mathcal{F}\psi)(y+l)|^2 dy. \end{aligned}$$

Thus the equality $f_k \stackrel{?}{=} c_k$ comes down to an interchange of the limit and the sum. If we were instead to consider the expression

$$\int_0^1 \sum_{l=-\infty}^{\infty} |v(y)| |(\mathcal{F}\psi)(y+l)|^2 dy,$$

the result would be $\int_0^1 |v(y)| dy \leq \|v\|_{L^2([0,1])}^2 = \|f\|_2^2$, which is finite. Therefore Fubini's Theorem shows the interchange to be justified, and we indeed have $f_k = c_k$ for all k . This proves completeness in W_0 of the orthonormal system $\{\psi_{0,k}\}_{k=-\infty}^{\infty}$.

Now suppose that $v(y)$ is any function in $L^2([0, 1])$ periodic of period 1 such that $|v(y)| = 1$ almost everywhere. Let f be the function in W_0 that corresponds to v , i.e., has $(\mathcal{F}f)(y) = v(y)(\mathcal{F}\psi)(y)$. Applying both directions of Lemma 10.11 to the identity

$$\sum_{l=-\infty}^{\infty} |(\mathcal{F}f)(y+l)|^2 = |v(y)|^2 \sum_{l=-\infty}^{\infty} |(\mathcal{F}\psi)(y+l)|^2 = \sum_{l=-\infty}^{\infty} |(\mathcal{F}\psi)(y+l)|^2$$

we see that $\{x \mapsto f(x - k)\}_{k=-\infty}^{\infty}$ is an orthonormal set in W_0 . Suppose that g is given in W_0 and that g arises from a periodic function $\mu(y)$ of period 1 by the formula $(\mathcal{F}g)(y) = \mu(y)(\mathcal{F}\psi)(y)$. Then

$$(\mathcal{F}g)(y) = (\mu(y)v(y)^{-1})v(y)(\mathcal{F}\psi)(y) = (\mu(y)v(y)^{-1})(\mathcal{F}f)(y),$$

and the function $\mu(y)v(y)^{-1}$ is in $L^2([0, 1])$. The same argument that shows the equality $f_k = c_k$ above shows that g is in the closed linear span of the functions $\{x \mapsto f(x - k)\}_{k=-\infty}^{\infty}$, and therefore $\mathcal{F}^{-1}(v(\mathcal{F}\psi))$ is a wavelet, as was asserted.

Finally if $v(y)$ is any periodic function of period 1 such that the function h with $(\mathcal{F}h)(y) = v(y)(\mathcal{F}\psi)(y)$ is a wavelet, then application of both halves of Lemma 10.11 shows that

$$1 = \sum_{l=-\infty}^{\infty} |\mathcal{F}h(y + l)|^2 = |v(y)|^2 \sum_{l=-\infty}^{\infty} |\mathcal{F}\psi(y + l)|^2 = |v(y)|^2$$

almost everywhere, and $|v(y)| = 1$ almost everywhere. □

4. Shannon Wavelet

We saw in Section 2 how the Haar wavelet could be defined and analyzed immediately from its definition. The advantage of the Haar system, not seen with Fourier series, is that classes of functions defined by their size are handled well by the Haar system. On the other hand, the functions $\psi_{j,k}$ of the Haar system are discontinuous, and wavelet expansions therefore cannot take advantage of smoothness of the function being expanded.

Thus other wavelets are needed with properties better suited for other purposes. The trouble is that the definitions of other wavelets are not so transparent. In this section we introduce the first of several useful examples of wavelets that are constructed directly from a multiresolution analysis with the aid of Theorem 10.10. With most such examples some supplementary argument is needed because the hypotheses of Theorem 10.10 do not directly fit with the example.

The example in this section, called the **Shannon system**, is exceptional in that verification of the hypotheses is fairly straightforward. It has

$$\varphi(x) = \frac{\sin(\pi x)}{\pi x} \quad \text{for } x \in \mathbb{R}$$

as scaling function and $V_j = \{f \in L^2(\mathbb{R}) \mid (\mathcal{F}f)(y) = 0 \text{ for } |y| > 2^{j-1}\}$ as the j^{th} closed subspace. As usual, φ is to lie in V_0 . The function φ arose in the Shannon Sampling Theorem (Proposition 10.3) when $\Omega = 1$. The proof of that result showed that $(\mathcal{F}\varphi)(y)$ equals the indicator function $I_{[-\frac{1}{2}, \frac{1}{2}]}(y)$ almost everywhere on \mathbb{R} . Thus indeed φ lies in V_0 .

Theorem 10.14. The Shannon system, consisting of the set of closed subspaces $\{V_j\}_{j=-\infty}^{\infty}$ and the function φ , is a multiresolution analysis. The corresponding wavelet may be taken to be

$$\psi(x) = -\frac{2(\sin(2\pi x) - \cos(\pi x))}{\pi(2x - 1)} \quad \text{for } x \in \mathbb{R}.$$

Its Fourier transform almost everywhere equals

$$(\mathcal{F}\psi)(y) = e^{-\pi iy}(I_{[-1, -\frac{1}{2}]}(y) + I_{[\frac{1}{2}, 1]}(y)) \quad \text{for } y \in \mathbb{R}.$$

REMARK. Graphs of φ and ψ appear in Figure 10.3. A new ingredient with this example, not seen with the Haar system, is that the scaling equation has infinitely many nonzero coefficients. We get at these coefficients through the associated generating function m_0 defined by $(\mathcal{F}\varphi)(2y) = m_0(y)(\mathcal{F}\varphi)(y)$, working with m_0 as a whole rather than with the individual coefficients. The function m_0 is periodic of period 1.

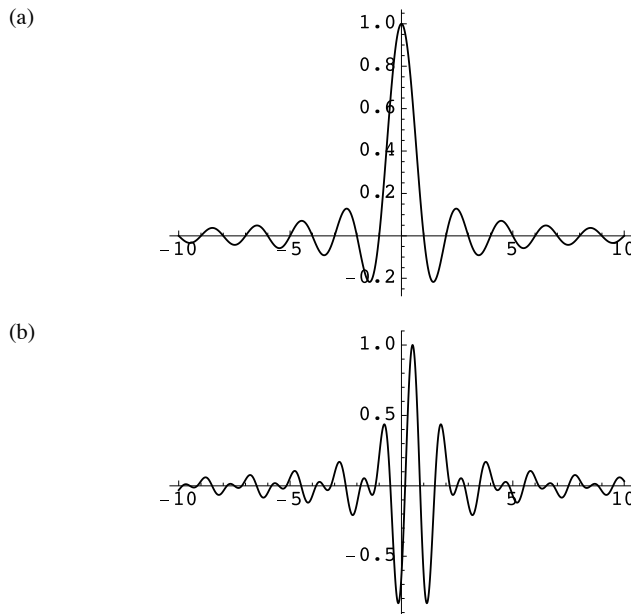

FIGURE 10.3. Graphs of Shannon scaling function and wavelet.
(a) Scaling function. (b) Wavelet.

PROOF. The closed subspaces V_j are nested, and their union is the set of functions in $L^2(\mathbb{R})$ whose Fourier transforms have compact support. This space is dense in $L^2(\mathbb{R})$ by the Plancherel Theorem. The intersection of the spaces V_j is the subspace of functions in $L^2(\mathbb{R})$ whose Fourier transforms are supported at 0, and that subspace is 0. Finally we have $(\mathcal{F}\varphi_{0,k})(y) = e^{-2\pi iky} I_{[-\frac{1}{2}, \frac{1}{2}]}(y)$. Since the functions $e^{-2\pi iky}$ form an orthonormal basis of $L^2([0, 1])$, the functions $\mathcal{F}\varphi_{0,k}$ form an orthonormal basis of $\mathcal{F}(V_0)$, and the functions $\varphi_{0,k}$, by the Plancherel Theorem, form an orthonormal basis of V_0 . Thus the Shannon system is a multiresolution analysis.

To get at ψ , we start from the formula $(\mathcal{F}\varphi)(2y) = m_0(y)(\mathcal{F}\varphi)(y)$, and we find for $|y| \leq \frac{1}{2}$ that

$$m_0(y) = \frac{(\mathcal{F}\varphi)(2y)}{\mathcal{F}\varphi(y)} = \frac{I_{[-\frac{1}{2}, \frac{1}{2}]}(2y)}{I_{[-\frac{1}{2}, \frac{1}{2}]}(y)} = I_{[-\frac{1}{4}, \frac{1}{4}]}(y).$$

For $|y| > \frac{1}{2}$, the function is to be extended periodically with period 1. Then we have

$$(\mathcal{F}\psi)(2y) = m_1(y)(\mathcal{F}\varphi)(y).$$

The formula for $m_1(y)$ involves $\overline{m_0(y + \frac{1}{2})}$, which is given by

$$\overline{m_0(y + \frac{1}{2})} = \begin{cases} 1 & \text{for } -\frac{3}{4} \leq y \leq -\frac{1}{4}, \\ 0 & \text{for } -\frac{1}{4} \leq y \leq \frac{1}{4}, \\ 1 & \text{for } \frac{1}{4} \leq y \leq \frac{3}{4}, \\ 0 & \text{for } \frac{3}{4} \leq y \leq \frac{5}{4}. \end{cases}$$

For $|y| \leq \frac{3}{4}$, this equals $I_{[-\frac{3}{4}, -\frac{1}{4}]}(y) + I_{[\frac{1}{4}, \frac{3}{4}]}(y)$, and thus

$$\overline{m_0(y + \frac{1}{2})} = I_{[-\frac{1}{2}, -\frac{1}{4}]}(y) + I_{[\frac{1}{4}, \frac{1}{2}]}(y) \quad \text{for } |y| \leq \frac{1}{2}.$$

Theorem 10.10a says that we can take ψ to be f in the formula

$$(\mathcal{F}f)(y) = e^{\pi iy} \nu(y) \overline{m_0(\frac{1}{2}y + \frac{1}{2})} (\mathcal{F}\varphi)(\frac{1}{2}y)$$

if we use $\nu(y) = e^{-2\pi iy}$. (We could as well use any other integer power of $e^{2\pi iy}$ as $\nu(y)$, and the effect will be to translate ψ by an integer. Our choice is arranged to make the graph in Figure 10.3b look pleasing.) In this case

$$(\mathcal{F}\psi)(2y) = e^{-2\pi iy} \overline{m_0(y + \frac{1}{2})} (\mathcal{F}\varphi)(y).$$

Since $(\mathcal{F}\varphi)(y) = I_{[-\frac{1}{2}, \frac{1}{2}]}(y)$ for all $y \in \mathbb{R}$, we obtain

$$(\mathcal{F}\psi)(2y) = e^{-2\pi iy} (I_{[-\frac{1}{2}, -\frac{1}{4}]}(y) + I_{[\frac{1}{4}, \frac{1}{2}]}(y))$$

and thus
$$(\mathcal{F}\psi)(y) = e^{-\pi iy} (I_{[-1, -\frac{1}{2}]}(y) + I_{[\frac{1}{2}, 1]}(y)),$$

as required. Forming the inverse Fourier transform of this function by direct computation yields

$$\psi(x) = \frac{2(\sin(2\pi(x - \frac{1}{2})) - \sin(\pi(x - \frac{1}{2})))}{\pi(2x - 1)} = -\frac{2(\sin(2\pi x) - \cos(\pi x))}{\pi(2x - 1)}. \quad \square$$

The wavelet ψ produced by Theorem 10.14 is called the **Shannon wavelet**. Since the Shannon wavelet is smooth, we have gotten around one defect of the Haar wavelet. But we have introduced other defects: the functions φ and ψ in the Shannon system fail to be in $L^1(\mathbb{R})$, and their Fourier transforms are discontinuous.

The examples in later sections will have more favorable smoothness properties, but each will have other drawbacks.

5. Construction of a Wavelet from a Scaling Function

We now aim for the Meyer wavelets, whose Fourier transforms have compact support and a specified degree of smoothness. Correspondingly the wavelets themselves are all of class C^∞ and have a specified degree of decrease at infinity. As is true with many examples, the spaces V_j in the relevant multiresolution analysis are hard to pin down without referring to the candidate for the scaling function φ . By contrast, in the Haar system the members of the spaces V_j were L^2 functions that were constant on certain kinds of intervals, and in the Shannon system the members of the spaces V_j were L^2 functions whose Fourier transforms vanished on certain sets.

However, when we are allowed to refer to φ , property (iv) of a multiresolution analysis shows that V_0 is always the closed subspace for which $\{x \mapsto \varphi(x - k)\}_{k \in \mathbb{Z}}$ is an orthonormal basis, and the other spaces V_j can be defined in terms of V_0 by the dilation property (iii). Thus the question arises how to tell whether a function φ in $L^2(\mathbb{R})$ for which $\{x \mapsto \varphi(x - k)\}_{k \in \mathbb{Z}}$ is an orthonormal set is the scaling function of a multiresolution analysis. The sequence $\{V_j\}$ will be increasing as soon as $V_0 \subseteq V_1$, i.e., as soon as φ satisfies a scaling equation. Evidently what is needed is to have reasonable sufficient conditions for the first two properties of a multiresolution analysis to be satisfied, namely

- (i) $\bigcup_j V_j$ is dense in $L^2(\mathbb{R})$,
- (ii) $\bigcap_j V_j = 0$.

We give such conditions in this section.

Proposition 10.15. Suppose that φ is a member of $L^2(\mathbb{R})$ such that

$$\{x \mapsto \varphi(x - k)\}_{k=-\infty}^{\infty}$$

is an orthonormal set. Let V_0 be the closed linear span of this orthonormal set, and define dilated spaces V_j by $V_j = \{f \in L^2(\mathbb{R}) \mid x \mapsto f(2^{-j}x) \text{ is in } V_0\}$. Then $\bigcap_{j=-\infty}^{\infty} V_j = 0$.

REMARK. In other words, property (ii) is automatic; no additional hypothesis on φ is needed. By contrast in Proposition 10.17 we shall impose an additional hypothesis on φ to ensure that property (i) holds.

PROOF. Define $\varphi_{j,k}(x) = 2^{j/2}\varphi(2^jx - k)$. The set $\{\varphi_{j,k}\}_{k=-\infty}^{\infty}$ is an orthonormal basis of V_j , and thus any f in V_j satisfies Parseval's equality,

$$\|f\|_2^2 = \sum_{k=-\infty}^{\infty} |(f, \varphi_{j,k})|^2.$$

Let f be in $\bigcap_{j=-\infty}^{\infty} V_j$. We are to prove that $f = 0$. Let $\epsilon > 0$ be given, and choose $g \in C_{\text{com}}(\mathbb{R})$ with $\|f - g\|_2 \leq \epsilon$. Let M be large enough so that the interval $[-M, M]$ contains the support of g , and suppose that $j < 0$ is large enough so that $2^{-|j|}M < \frac{1}{2}$. If P_j denotes the orthogonal projection of $L^2(\mathbb{R})$ on V_j , then

$$\|f - P_j g\|_2 = \|P_j(f - g)\|_2 \leq \|f - g\|_2 \leq \epsilon,$$

and hence

$$\|f\|_2 \leq \epsilon + \|P_j g\|_2. \quad (*)$$

Also we have

$$\begin{aligned} \|P_j g\|_2^2 &= \sum_{k=-\infty}^{\infty} |(g, \varphi_{j,k})|^2 \\ &\leq 2^{-|j|} \sum_{k=-\infty}^{\infty} \left(\int_{x \in \mathbb{R}} |g(x)| |\varphi(2^{-|j|x} - k)| dx \right)^2 \\ &= 2^{-|j|} \sum_{k=-\infty}^{\infty} \left(\int_{|x| \leq M} |g(x)| |\varphi(2^{-|j|x} - k)| dx \right)^2 \\ &\leq 2^{-|j|} \|g\|_{\text{sup}}^2 \sum_{k=-\infty}^{\infty} \left(\int_{|x| \leq M} |\varphi(2^{-|j|x} - k)| dx \right)^2 \\ &\leq 2^{-|j|} \|g\|_{\text{sup}}^2 2M \sum_{k=-\infty}^{\infty} \int_{|x| \leq M} |\varphi(2^{-|j|x} - k)|^2 dx \\ &\quad \text{by the Schwarz inequality} \\ &= \|g\|_{\text{sup}}^2 2M \sum_{k=-\infty}^{\infty} \int_{|x'| \leq 2^{-|j|M}} |\varphi(x' - k)|^2 dx' \\ &= \|g\|_{\text{sup}}^2 2M \sum_{k=-\infty}^{\infty} \int_{|x+k| \leq 2^{-|j|M}} |\varphi(x)|^2 dx. \end{aligned}$$

Since $2^{-|j|}M < \frac{1}{2}$, the sets of integration on the right side are disjoint, and we can write the right side as

$$= \|g\|_{\text{sup}}^2 2M \int_{E_j} |\varphi(x)|^2 dx,$$

where E_j is the set of reals at a distance of $\leq 2^{-|j|}M$ from \mathbb{Z} . As $|j|$ tends to infinity, these sets decrease to \mathbb{Z} , which has measure 0. In view of Corollary 5.3 of *Basic*, the complete additivity of the finite measure $|\varphi(x)|^2 dx$ implies that this expression tends to 0. By (*), $\|f\|_2 \leq \varepsilon$. Since ε is arbitrary, f is the zero element of $L^2(\mathbb{R})$. \square

Lemma 10.16. Suppose that φ is a member of $L^2(\mathbb{R})$ such that

$$\{x \mapsto \varphi(x - k)\}_{k=-\infty}^{\infty}$$

is an orthonormal set. Let V_0 be the closed linear span of this orthonormal set, and define dilated spaces V_j by $V_j = \{f \in L^2(\mathbb{R}) \mid x \mapsto f(2^{-j}x) \text{ is in } V_0\}$. For $j > 0$, let P_j be the orthogonal projection of $L^2(\mathbb{R})$ on V_j . If f is a member of $L^2(\mathbb{R})$ whose Fourier transform $\mathcal{F}f$ is bounded and is supported in the interval $[-M, M]$, then

$$\|P_j f\|_2^2 = \int_{-M}^M |(\mathcal{F}f)(y)|^2 |(\mathcal{F}\varphi)(2^{-j}y)|^2 dy$$

when j is large enough so that $2^{j-1} > M$.

PROOF. With $\varphi_{j,k}(x) = 2^{j/2}\varphi(2^j x - k)$, we have

$$\begin{aligned} \|P_j f\|_2^2 &= \sum_{k \in \mathbb{Z}} |(f, \varphi_{j,k})|^2 \\ &= \sum_{k \in \mathbb{Z}} \left| \int_{-M}^M (\mathcal{F}f)(y) \overline{(\mathcal{F}\varphi_{j,k})(y)} dy \right|^2 && \text{by the Plancherel Theorem} \\ &= \sum_{k \in \mathbb{Z}} \left| \int_{-M}^M (\mathcal{F}f)(y) e^{-2\pi i k 2^{-j} y} 2^{-j/2} \overline{(\mathcal{F}\varphi)(2^{-j}y)} dy \right|^2 \\ &= \sum_{k \in \mathbb{Z}} 2^{-j} \left| \int_{-2^{j-1}}^{2^{j-1}} (\mathcal{F}f)(y) e^{-2\pi i k 2^{-j} y} \overline{(\mathcal{F}\varphi)(2^{-j}y)} dy \right|^2, \end{aligned} \quad (*)$$

the last equality holding since $2^{j-1} > M$. The integral in the k^{th} term on the right is the k^{th} Fourier coefficient of an L^2 function on $[-2^{j-1}, 2^{j-1}]$, specifically of

$$(\mathcal{F}f)(y) \overline{(\mathcal{F}\varphi)(2^{-j}y)},$$

and Parseval's Theorem shows that the sum over $k \in \mathbb{Z}$ of the absolute values squared of these coefficients equals the norm squared of the function in the space $L^2([-2^{j-1}, 2^{j-1}], dx)$. Thus (*) equals

$$\int_{-2^{j-1}}^{2^{j-1}} |(\mathcal{F}f)(y) \overline{(\mathcal{F}\varphi)(2^{-j}y)}|^2 dy. \quad \square$$

Proposition 10.17. Suppose that φ is a member of $L^2(\mathbb{R})$ such that

$$\{x \mapsto \varphi(x - k)\}_{k=-\infty}^{\infty}$$

is an orthonormal set. Let V_0 be the closed linear span of this orthonormal set, and define dilated spaces V_j by $V_j = \{f \in L^2(\mathbb{R}) \mid x \mapsto f(2^{-j}x) \text{ is in } V_0\}$. Under the additional hypothesis that $\mathcal{F}\varphi$ is a bounded function that is continuous and nonzero at $y = 0$, the vector subspace $\sum_{j=-\infty}^{\infty} V_j$ generated by all the V_j is dense in $L^2(\mathbb{R})$.

REMARK. We shall use this result only when $V_0 \subseteq V_1$, in which case $\{V_j\}$ is an increasing sequence and $\sum_{j=-\infty}^{\infty} V_j = \bigcup_{j=-\infty}^{\infty} V_j$.

PROOF. Let P_j be the orthogonal projection on V_j . Arguing by contradiction, suppose that f is a nonzero element in the orthogonal complement of $\bigcup_{j=-\infty}^{\infty} V_j$. Certainly $P_j f = 0$ for all j . Let $\epsilon > 0$ be given, and assume that ϵ is small enough so that

$$\epsilon(1 + |(\mathcal{F}\varphi)(0)|) < |(\mathcal{F}\varphi)(0)| \|f\|_2. \quad (*)$$

This is possible since $(\mathcal{F}\varphi)(0)$ and $\|f\|_2$ are nonzero. Choose a function g in $L^2(\mathbb{R})$ such that $\mathcal{F}g$ has compact support and $\|f - g\|_2 \leq \epsilon$. Then $\|P_j g\|_2 = \|P_j(g - f)\|_2 \leq \|g - f\|_2 \leq \epsilon$.

Say that the support of $\mathcal{F}g$ is contained in the interval $[-M, M]$. Referring to Lemma 10.16, we then have

$$\epsilon^2 \geq \|P_j g\|_2^2 = \int_{-M}^M |(\mathcal{F}g)(y)|^2 |\mathcal{F}\varphi(2^{-j}y)|^2 dy. \quad (**)$$

Since $\mathcal{F}\varphi$ is bounded and $\mathcal{F}g$ is square integrable and $\mathcal{F}\varphi$ is continuous at 0, the Dominated Convergence Theorem applies and shows that the right side of (**) tends to

$$\int_{-M}^M |(\mathcal{F}g)(y)| |(\mathcal{F}\varphi)(0)|^2 dy$$

as j tends to $+\infty$. Thus we obtain

$$\epsilon^2 \geq |(\mathcal{F}\varphi)(0)|^2 \|\mathcal{F}g\|_2^2 = |(\mathcal{F}\varphi)(0)|^2 \|g\|_2^2 \geq |(\mathcal{F}\varphi)(0)|^2 (\|f\|_2 - \epsilon)^2,$$

an inequality that contradicts (*). □

6. Meyer Wavelets

Now we can proceed with the construction of the Meyer wavelets. The definition of the Meyer multiresolution analysis involves the choice of a continuous function ν on \mathbb{R} that is of class C^m or perhaps C^∞ and that is 0 for $y \leq 0$ and is 1 for $y \geq 1$. It is assumed that ν satisfies

$$\nu(y) + \nu(1 - y) = 1 \quad \text{for } y \in \mathbb{R}.$$

This function will be incorporated into the definition of the Fourier transform of the scaling function φ .

There are no further assumptions. However, the interest in the Meyer wavelets is normally in the effect of the order of continuous differentiability on what happens, and at least when the order of continuous differentiability is finite, the convention is to choose the function ν of class C^m as computationally simple as possible so that it meets the above conditions.¹⁰ With this understanding for each finite $m \geq 0$, there is a unique such ν whose polynomial part has lowest degree.¹¹ That degree turns out to be $2m + 1$, and the polynomial is

$$x^{m+1} \sum_{k=0}^m \binom{m+k}{k} (1-x)^k.$$

The convention is to take ν to be that polynomial on $[0, 1]$, extended by 0 for $x \leq 0$ and extended by 1 for $x \geq 1$. We shall call the resulting multiresolution analysis the “Meyer multiresolution analysis” of **index** m . Figure 10.4 shows that graph of $\nu(x)$ for $m = 3$. The table in Figure 10.5 lists the polynomial explicitly for a few cases.

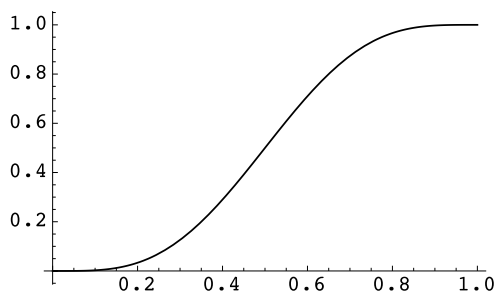

FIGURE 10.4. Graph of Meyer polynomial function when $m = 3$.

¹⁰Specifically the conditions are that ν is 0 for $y \leq 0$, is 1 for $y \geq 1$, is a polynomial function between 0 and 1, satisfies $\nu(y) + \nu(1 - y) = 1$, and is in the class C^m on \mathbb{R} .

¹¹See Problems 13–17 at the end of the chapter.

m	Polynomial $v(x)$ for $0 \leq x \leq 1$
0	x
1	$x^2(3 - 2x)$
2	$x^3(10 - 15x + 6x^2)$
3	$x^4(35 - 84x + 70x^2 - 20x^3)$
4	$x^5(126 - 420x + 540x^2 - 315x^3 + 70x^4)$
5	$x^6(462 - 1980x + 3465x^2 - 3080x^3 + 1386x^4 - 252x^5)$
6	$x^7(1716 - 9009x + 20020x^2 - 24024x^3 + 16380x^4 - 6006x^5 + 924x^6)$

FIGURE 10.5. Table of values of the polynomial part of $v(x)$ used in defining the Meyer wavelet of index m .

With v in hand, we define the Meyer scaling function φ through its Fourier transform $\mathcal{F}\varphi$ by

$$(\mathcal{F}\varphi)(y) = \begin{cases} 1 & \text{for } |y| \leq \frac{1}{3}, \\ \cos\left(\frac{\pi}{2}v(3|y| - 1)\right) & \text{for } \frac{1}{3} \leq |y| \leq \frac{2}{3}, \\ 0 & \text{for } \frac{2}{3} \leq |y|. \end{cases}$$

A plot of $\mathcal{F}\varphi$ for the case with $m = 3$ in the above table appears in Figure 10.6.

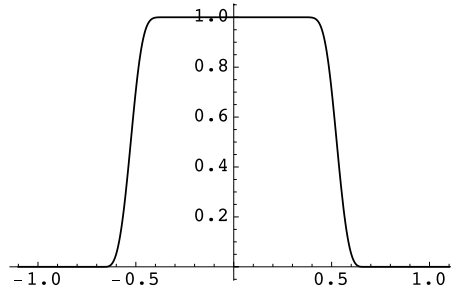

FIGURE 10.6. Graph of $\mathcal{F}\varphi$ for the Meyer wavelet when $m = 3$.

It will be seen in Theorem 10.18 below that $\{x \mapsto \varphi(x - k)\}_{k=-\infty}^{\infty}$ is an orthonormal set, hence that φ is a candidate for a scaling function. Then we let V_0 be the closed linear span of this orthonormal set and define dilated spaces V_j as usual by $V_j = \{f \in L^2(\mathbb{R}) \mid x \mapsto f(2^{-j}x) \text{ is in } V_0\}$. The spaces V_j will be seen to be nested. The **Meyer system corresponding to v** consists of φ and the nested sequence of spaces $\{V_j\}_{j=-\infty}^{\infty}$.

Theorem 10.18. Let $v : \mathbb{R} \rightarrow [0, 1]$ be a continuous function such that

- (i) $v(t) = 0$ for $t \leq 0$,

- (ii) $v(t) = 1$ for $t \geq 1$,
 (iii) $v(t) + v(1 - t) = 1$ for all $t \in \mathbb{R}$.

Then the Meyer system corresponding to v is a multiresolution analysis. The corresponding wavelet ψ may be taken to have Fourier transform given by

$$(\mathcal{F}\psi)(y) = e^{\pi iy}((\mathcal{F}\varphi)(y + 1) + (\mathcal{F}\varphi)(y - 1))(\mathcal{F}\varphi)(\frac{1}{2}y).$$

REMARKS. It is instructive to see how $e^{-\pi iy}(\mathcal{F}\psi)$ relates to $\mathcal{F}\varphi$. For this purpose, compare the graph of $\mathcal{F}\varphi$ in Figure 10.6 with that of $e^{-\pi iy}(\mathcal{F}\psi)$ in Figure 10.7 below. Figure 10.8 after the proof shows graphs of φ and ψ .

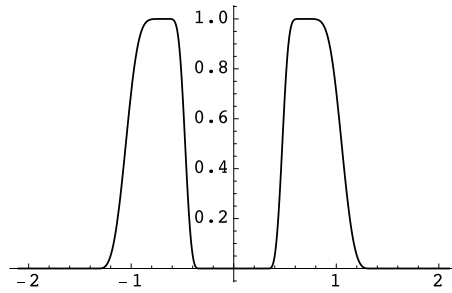

FIGURE 10.7. Graph of $e^{-\pi iy} \mathcal{F}\psi$ for the Meyer wavelet when $m = 3$.

PROOF. To see that φ and the spaces V_j form a multiresolution analysis, let us first compute

$$\sum_l |(\mathcal{F}\varphi)(y + l)|^2. \quad (*)$$

Expression (*) is manifestly periodic of period 1, and we may assume that $0 \leq y \leq 1$. For $0 \leq y \leq \frac{1}{3}$, the only nonzero term is for $l = 0$, and it is 1. For $\frac{2}{3} \leq y \leq 1$, the only nonzero term is for $l = -1$, and it is 1. For $\frac{1}{3} \leq y \leq \frac{2}{3}$, the only terms that contribute are for $l = 0$ and $l = -1$, and the sum of the contributions is

$$\cos^2(\frac{\pi}{2}v(3y - 1)) + \cos^2(\frac{\pi}{2}v(2 - 3y)). \quad (**)$$

The arguments of v in (**) have sum 1, and therefore the sum of their values is 1, since we are assuming that $v(t) + v(1 - t) = 1$ for all real t . Thus (**) is of the form $\cos^2 \frac{\pi}{2}u + \cos^2 \frac{\pi}{2}(1 - u) = \cos^2 u + \sin^2 u = 1$. In other words, (*) equals 1 for all y . By Lemma 10.11, $\{x \mapsto \varphi(x - k)\}_{k=-\infty}^{\infty}$ is an orthonormal set.

As at the beginning of Section 5, we define V_0 to be the closed linear span of $\{x \mapsto \varphi(x - k)\}_{k \in \mathbb{Z}}$, and we put $V_j = \{f \mid x \mapsto f(2^{-j}x) \text{ is in } V_0\}$. We need to show that $V_0 \subseteq V_1$, i.e., that φ satisfies a scaling equation. We define a periodic function μ_0 of period 1 by

$$\mu_0(y) = \sum_{l=-\infty}^{\infty} (\mathcal{F}\varphi)(2y + 2l). \quad (\dagger)$$

In a neighborhood of any fixed y , this is a finite sum because $\mathcal{F}\varphi$ has compact support. Thus $\mu_0(y)$ is meaningful, and on $[0, 1]$, the function μ_0 is square integrable. Let check that $\mu_0(y)$ satisfies

$$\mu_0(y/2)(\mathcal{F}\varphi)(y/2) = (\mathcal{F}\varphi)(y) \quad \text{for all } y \in \mathbb{R}. \quad (\dagger\dagger)$$

To prove $(\dagger\dagger)$, we observe for each $l \neq 0$ that the contribution to $(\dagger\dagger)$ given by $(\mathcal{F}\varphi)(y+2l)(\mathcal{F}\varphi)(y/2)$ is 0. In fact, for it to be nonzero requires that $|y+2l| < \frac{2}{3}$ (and hence $|y| > \frac{4}{3}$), as well as $|y/2| < \frac{2}{3}$, and there are no values of y where these conditions are met. Thus proving $(\dagger\dagger)$ comes down to proving the equality

$$(\mathcal{F}\varphi)(y) = (\mathcal{F}\varphi)(y)(\mathcal{F}\varphi)(y/2) \quad \text{for all } y \in \mathbb{R}. \quad (\ddagger)$$

There are two cases. One case is that $|y| \geq \frac{2}{3}$, and then $(\mathcal{F}\varphi)(y) = 0$ and both sides are equal. The other case is that $|y| \leq \frac{2}{3}$, and then $|y/2| \leq \frac{1}{3}$, so that $(\mathcal{F}\varphi)(y/2) = 1$; in this case each side of (\ddagger) equals $(\mathcal{F}\varphi)(y)$, and the two sides are equal. Thus (\ddagger) holds in both cases, and in particular, $(\dagger\dagger)$ is proved.

Since μ is periodic of period 1, we can write $\mu_0(y) = \frac{1}{\sqrt{2}} \sum_k c_k e^{-2\pi i k y}$. If we substitute this expression into $(\dagger\dagger)$ and apply \mathcal{F}^{-1} to $(\dagger\dagger)$, we see that φ satisfies the scaling equation $\varphi(x) = \sum_k c_k \sqrt{2} \varphi(2x - k)$. That is, we can conclude from (\dagger) and $(\dagger\dagger)$ together that $V_0 \subseteq V_1$ and that the generating function for φ is given by¹²

$$m_0(y) = \sum_{l=-\infty}^{\infty} (\mathcal{F}\varphi)(2y + 2l).$$

Thus we are in a position to apply Propositions 10.15 and 10.17 to see that we have a multiresolution analysis. Proposition 10.15 says that condition (ii) is always satisfied when the V_j 's are defined as above from the candidate for a scaling function. Proposition 10.17 says that condition (i) is satisfied if $\mathcal{F}\varphi$ is bounded, is continuous at 0, and has $(\mathcal{F}\varphi)(0) \neq 0$; all of these hypotheses can be seen by inspection of the definition of $(\mathcal{F}\varphi)(y)$ before the statement of the theorem, and thus indeed we have a multiresolution analysis.

Theorem 10.10 applies, and we are left with computing ψ . The theorem tells us what functions we can take as ψ . One of them is given by

$$(\mathcal{F}\psi)(y) = e^{\pi i y} \overline{m_0(\frac{1}{2}y + \frac{1}{2})} (\mathcal{F}\varphi)(\frac{1}{2}y).$$

Since $\mathcal{F}\varphi$ is real-valued, we can drop the complex conjugation and obtain

$$(\mathcal{F}\psi)(y) = e^{\pi i y} \sum_{l=-\infty}^{\infty} (\mathcal{F}\varphi)(y + 2l + 1) (\mathcal{F}\varphi)(\frac{1}{2}y).$$

¹²Even with an interpretation of L^2 convergence in the formula defining μ_0 , we make no assertion that this kind of formula yields m_0 beyond the context of Meyer wavelets.

For the l^{th} term to be nonzero, we must have $|y/2| < \frac{2}{3}$ and $|y + 2l + 1| < \frac{2}{3}$, and thus $l = 0$ or $l = -1$. Thus

$$(\mathcal{F}\psi)(y) = e^{\pi iy}((\mathcal{F}\varphi)(y + 1) + (\mathcal{F}\varphi)(y - 1))(\mathcal{F}\varphi)(\frac{1}{2}y). \quad \square$$

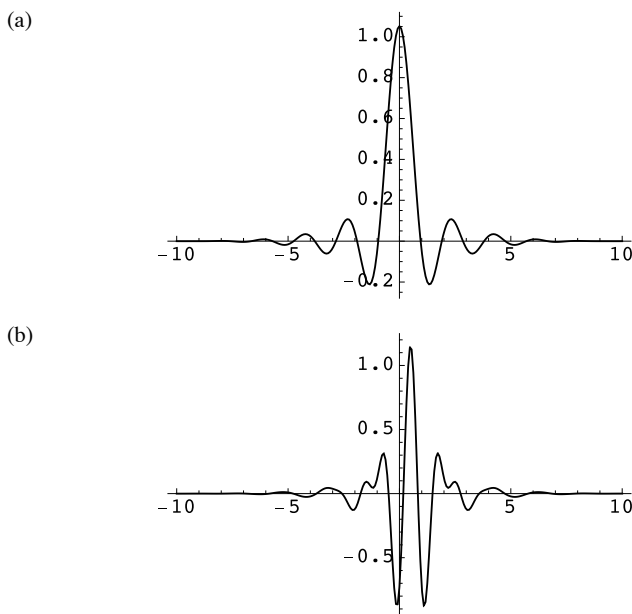

FIGURE 10.8. Graphs of Meyer scaling function and wavelet when $m = 3$.
(a) Scaling function. (b) Wavelet.

7. Splines

A “spline” for our purposes is a piecewise-polynomial function on an interval $[a, b]$ with certain smoothness conditions at the edges of the pieces. Specifically let

$$a = x_0 < x_1 < \cdots < x_m = b$$

be a partition of $[a, b]$. If $n < m$, a **spline of degree n** relative to this partition¹³ is a function $\sigma(x)$ such that

- (i) for each i , the restriction of $\sigma(x)$ to the interval $[x_{i-1}, x_i]$ is a real-valued polynomial p_i of degree at most n ,
- (ii) $\sigma(x)$ is of class C^{n-1} on $[a, b]$.

¹³The situation in which some points of the partition are repeated will not be of interest to us and will not be addressed.

The points x_i of the partition are called the **knots** of the spline.¹⁴

We shall be interested only in splines with equally spaced knots, for example at the integer points in the interval $[a, b]$, and we shall be especially interested in splines that can be extended to members of $C^{n-1}(\mathbb{R})$ that are zero on $(-\infty, a]$ and $[b, +\infty)$. These we call the **splines of compact support** (with knots in \mathbb{Z}).

The case of degree 0 is something we have seen before. In the case of degree 0, the splines of compact support with knots in \mathbb{Z} are the functions on \mathbb{R} that are constant on every interval between consecutive integers and that vanish outside a compact subset of \mathbb{R} . These are the finite linear combinations of integer translates of the Haar scaling function,¹⁵ which we shall call ${}^0\gamma$ in this section and the next. The closure of this vector subspace of $L^2(\mathbb{R})$ is the subspace V_0 from which the Haar multiresolution analysis is built.

We wish to generalize the Haar construction to splines of higher degree. For $n > 0$, the spline function $\sigma(x)$ has to be continuous at the knots, and so do its derivatives up through order $n - 1$. Being a polynomial on each interior interval, $\sigma(x)$ has right and left limits at each knot, and the same thing is true of each derivative. The difference between these limits can be nonzero only for the n^{th} derivative, all derivatives higher than n giving 0, and

$$\lim_{x \downarrow x_i} p_{i+1}^{(n)}(x) - \lim_{x \uparrow x_i} p_i^{(n)}(x) = c_i$$

is the jump of the n^{th} derivative. Then it follows that

$$p_{i+1}(x) - p_i(x) - \frac{c_i}{n!}(x - x_i)^n$$

has all derivatives 0 in a neighborhood of x_i and must be the zero polynomial:

$$p_{i+1}(x) = p_i(x) + \frac{c_i}{n!}(x - x_i)^n.$$

This formula gives us a handle on the dimension of the vector space of splines of degree n on $[a, b]$. Again the knots are understood to be at the integer points.

For now, let us restrict attention to the case of degree 1. We introduce a spline ${}^1\gamma$ of degree 1 by the definition

$${}^1\gamma(x) = \begin{cases} x & \text{for } 0 \leq x \leq 1, \\ 2 - x & \text{for } 1 \leq x \leq 2, \\ 0 & \text{otherwise.} \end{cases}$$

¹⁴Under our assumption that there are no repetitions among the points of the spline, the knots are all "simple."

¹⁵The values of the function at integer points are not relevant as long as we are studying $L^2(\mathbb{R})$.

See Figure 10.9. The integer translates of ${}^1\gamma$, given by ${}^1\gamma_{0,k}(x) = {}^1\gamma(x - k)$, will also be of interest. Each of them is a spline of compact support. Comparison of their supports shows that they are linearly independent.

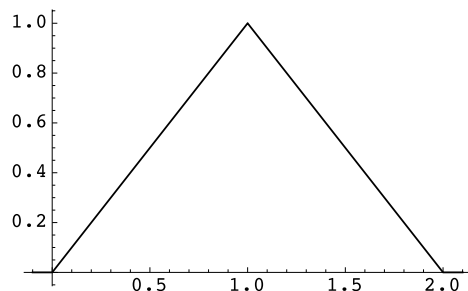

FIGURE 10.9. Graph of the B -spline ${}^1\gamma$.

The functions ${}^1\gamma_{0,k}$ are called **B -splines** of degree 1, the “ B ” being short for basis. The following result justifies this terminology.

Proposition 10.19. The B -splines of degree 1 form a vector-space basis of the vector space of all splines of degree 1 of compact support with knots in \mathbb{Z} .

PROOF. We need to prove spanning. Suppose that the spline is supported in $[M, N]$ with $M < N$. We shall subtract a multiple of a B -spline to reduce the support. Thus suppose the support of a spline $s(x)$ is contained in $[M, N]$. Let us say that the derivative $s'(x)$ has a jump by c at $x = M$, c possibly being 0. In this case the boxed jump formula shows that $s(x) = c(x - M)$ for $M \leq x \leq M + 1$. Consequently $s(x) - c {}^1\gamma_{0,M}(x)$ is a spline of degree 1 supported in $[M + 1, N]$. The support has been reduced, and in finitely many steps we end up with the difference of $s(x)$ and a linear combination of B -splines exhibited as supported in the interval $[N - 1, N]$. A spline of degree 1 that vanishes at each end has to be the 0 spline, and thus the difference of $s(x)$ and a linear combination of B -splines is 0. In other words, $s(x)$ equals a linear combination of B -splines. \square

Let V_0 be the closure in $L^2(\mathbb{R})$ of the vector spaces of all splines of degree 1 of compact support with knots in \mathbb{Z} . It begins to look as if V_0 and ${}^1\gamma$ might yield a multiresolution analysis generalizing the Haar multiresolution analysis—until we stop to realize that the B -splines ${}^1\gamma_{0,k}$ are not orthogonal to one another. In fact, two of them are orthogonal if and only if their supports have no nontrivial interval in common. Nevertheless we plunge ahead by writing down a scaling equation and by computing the Fourier transform of ${}^1\gamma$.

The scaling equation for ${}^1\gamma$ is

$${}^1\gamma(x) = \frac{1}{2} {}^1\gamma(2x) + {}^1\gamma(2x - 1) + \frac{1}{2} {}^1\gamma(2x - 2);$$

we can check this equality directly when x is an integer multiple of $\frac{1}{2}$, and then the equality follows everywhere.

The computation of the Fourier transform of ${}^1\gamma$ can be carried out directly, using integration by parts suitably, but we prefer the following alternative argument, which deduces it as Corollary 10.22 from the Fourier transform of the indicator function $I_{[0,1]}$ and an identity concerning convolutions.

Proposition 10.20. The Fourier transform of ${}^0\gamma = I_{[0,1]}$ is given by

$$(\mathcal{F}^0\gamma)(y) = \frac{e^{-2\pi iy} - 1}{-2\pi iy} = e^{-\pi iy} \left(\frac{\sin \pi y}{\pi y} \right).$$

PROOF. The quantity in question equals $\int_0^1 e^{-2\pi ixy} dx$. □

Proposition 10.21. The B -spline ${}^1\gamma$ is the convolution of the indicator function ${}^0\gamma = I_{[0,1]}$ with itself:

$${}^1\gamma(x) = \int_{\mathbb{R}} I_{[0,1]}(x-t)I_{[0,1]}(t) dt = \int_0^1 I_{[0,1]}(x-t) dt.$$

PROOF. The integral in question is 0 if $x \leq 0$ or $x \geq 2$. For $0 \leq x \leq 2$, the change of variables $u = x - t$ shows that it equals

$$\int_{x-1}^x I_{[0,1]}(u) du = \int_{\max\{0, x-1\}}^{\min\{1, x\}} 1 du = \min\{1, x\} - \max\{0, x-1\};$$

this equals x if $0 \leq x \leq 1$ or else equals $1 - (x - 1) = 2 - x$ if $1 \leq x \leq 2$. □

Corollary 10.22. The Fourier transform of the B -spline ${}^1\gamma$ is given by

$$(\mathcal{F}^1\gamma)(y) = e^{-2\pi iy} \left(\frac{\sin \pi y}{\pi y} \right)^2.$$

PROOF. The Fourier transform of a convolution is the product of the Fourier transforms, by Proposition 8.1c of *Basic*. Thus the result follows by combining Propositions 10.20 and 10.21. □

The Fourier transform of the scaling equation of ${}^1\gamma$ is

$$(\mathcal{F}^1\gamma)(y) = \frac{1}{2}(\mathcal{F}^1\gamma)(y/2) + 1(\frac{1}{2}e^{-\pi iy}(\mathcal{F}^1\gamma)(y/2)) + \frac{1}{2}(\frac{1}{2}e^{-2\pi iy}(\mathcal{F}^1\gamma)(y/2)).$$

We can check this equation explicitly by using Corollary 10.22 and thereby verify the original scaling equation itself. The question is whether

$$\begin{aligned} e^{-2\pi iy} \left(\frac{\sin \pi y}{\pi y} \right)^2 &\stackrel{?}{=} \frac{1}{2}(\mathcal{F}^1\gamma)(y/2) \left(\frac{1}{2} + e^{-\pi iy} + \frac{1}{2}e^{-2\pi iy} \right) \\ &= \frac{1}{2}(\mathcal{F}^1\gamma)(y/2) e^{-\pi iy} (1 + \cos \pi y) \end{aligned}$$

$$\begin{aligned}
&= (\mathcal{F}^1 \gamma)(y/2) e^{-\pi i y} \cos^2 \pi y/2 \\
&= e^{-\pi i y} e^{-\pi i y} \left(\frac{\sin^2 \pi y/2}{\pi^2 y^2/4} \right) \cos^2 \pi y/2,
\end{aligned}$$

and this comes down to the identity $\sin 2\theta = 2 \sin \theta \cos \theta$.

Motivated by Lemma 10.11, we now calculate

$$\Delta(y) = \sum_{l=-\infty}^{\infty} |(\mathcal{F}^1 \gamma)(y+l)|^2$$

We know that the sum cannot be almost everywhere equal to 1, since $\{\gamma_{0,k}\}$ is not an orthonormal set. However, the value of the sum will contain useful information for us. To make the calculation, we need to use some elementary complex analysis. We shall take as our starting point the results of Appendix B of *Basic*.

Proposition 10.23. For complex z ,

$$\frac{\pi^2}{\sin^2 \pi z} = \sum_{n=-\infty}^{\infty} \frac{1}{(z-n)^2},$$

the series being uniformly convergent on compact sets that contain no integers.

PROOF. The series is convergent for $z \notin \mathbb{Z}$ by comparison with the series $\sum_{n=1}^{\infty} (1/n^2)$. If the terms corresponding to integers in a fixed closed disk about 0 are excluded, then the same comparison shows that the convergence is uniform on the disk. By Problem 55 in Appendix B of *Basic*, the sum of the series is meromorphic in \mathbb{C} with poles of order 2 at each integer. The function $\pi^2/\sin^2(\pi z)$ has the same property, and therefore the difference

$$g(z) = \frac{\pi^2}{\sin^2 \pi z} - \sum_{n=-\infty}^{\infty} \frac{1}{(z-n)^2} \quad (*)$$

is analytic in all of \mathbb{C} . We show that $g(z)$ is the zero function.

Each term on the right side of (*) is periodic of period 1, and thus the same thing is true of $g(z)$. By Liouville's Theorem it is enough to prove that $|g(x+iy)|$ tends to 0 uniformly for $|x| \leq 1$ as $y \rightarrow \infty$. Consider the first term on the right side of (*). Direct calculation gives

$$\begin{aligned}
|\sin z|^2 &= \frac{1}{4} (e^{i(x+iy)} - e^{-i(x+iy)}) \overline{(e^{i(x+iy)} - e^{-i(x+iy)})} \\
&= \frac{1}{4} (e^{-2y} - e^{-2ix} - e^{2ix} + e^{2y}) = \cosh^2 y - \cos^2 x,
\end{aligned}$$

and the reciprocal of this tends to 0 uniformly for all x as $y \rightarrow \infty$. This takes care of the first term of the right side of (*). For the second term we have

$$\left| \frac{1}{(z-n)^2} \right| = \frac{1}{(x-n)^2 + y^2}.$$

This has the required behavior for the terms with $|n| \leq 2$. For the terms with $|n| \geq 3$, we have $\frac{1}{(x-n)^2 + y^2} \leq \frac{1}{(|n|-1)^2 + y^2}$. Given $\epsilon > 0$ with ϵ equal to the reciprocal of an integer, suppose that $|y| \geq \epsilon^{-1}$. Then

$$\sum_{|n|=2}^{1/\epsilon} \frac{1}{(|n|-1)^2 + y^2} \leq \sum_{|n|=2}^{1/\epsilon} \frac{1}{y^2} \leq 2(1/\epsilon)y^{-2} \leq 2\epsilon$$

and

$$\sum_{|n|=1/\epsilon}^{\infty} \frac{1}{(|n|-1)^2 + y^2} \leq \sum_{|n|=1/\epsilon}^{\infty} \frac{1}{(|n|-1)^2} \leq \sum_{|n|=1/\epsilon}^{\infty} \left(\frac{1}{|n|-2} - \frac{1}{|n|-1} \right) = \frac{2}{\epsilon^{-1}-2},$$

which is $\leq 6\epsilon$ as long as $\epsilon < \frac{1}{3}$. This takes care of the second term on the right side of (*). \square

Corollary 10.24. For every integer $m \geq 0$,

$$\left(\frac{d}{dz} \right)^m \left(\frac{\pi^2}{\sin^2 \pi z} \right) = (m+1)! \sum_{n=-\infty}^{\infty} \frac{1}{(z-n)^{m+2}}$$

PROOF. This formula results from successive term-by-term differentiation of the result of Proposition 10.23. To justify the interchange of derivative and sum, we make repeated use of the standard technique of Appendix B of *Basic*, writing the complex derivative as a suitable line integral and using Fubini's Theorem to interchange the integral and the infinite sum. \square

Returning to the calculation of $\sum_{l=-\infty}^{\infty} |(\mathcal{F}^1 \gamma)(y+l)|^2$, we combine Corollary 10.22 with the formula of Corollary 10.24 when $m = 2$. Then

$$\begin{aligned} \Delta(y) &= \sum_{l=-\infty}^{\infty} |(\mathcal{F}^1 \gamma)(y+l)|^2 = \sum_{l=-\infty}^{\infty} \left| \frac{\sin \pi(y+l)}{\pi(y+l)} \right|^4 \\ &= \frac{\sin^4(\pi y)}{\pi^4} \sum_{l=-\infty}^{\infty} \frac{1}{(y+l)^4} \\ &= \frac{\sin^4(\pi y)}{6\pi^4} \frac{d^2}{dy^2} \left(\frac{\pi^2}{\sin^2 \pi y} \right) \\ &= \frac{1}{3} (\sin^2 \pi y + 3 \cos^2 \pi y) \\ &= \frac{1}{3} (1 + 2 \cos^2 \pi y). \end{aligned}$$

In other words, the periodic function $\Delta(y) = \sum_{l=-\infty}^{\infty} |(\mathcal{F}^1 \gamma)(y+l)|^2$ of period 1 is bounded above and below by the positive constants 1 and $\frac{1}{3}$. In terminology used by many authors, this means that the integer translates of $\mathcal{F}^1 \gamma$ form a ‘‘Riesz system.’’ In practical terms it means that we can use a general method to construct an orthonormal system out of $\mathcal{F}^1 \gamma$. We proceed as follows.

We define a member φ of $L^2(\mathbb{R})$ by

$$(\mathcal{F}\varphi)(y) = \Delta(y)^{-1/2}(\mathcal{F}^1 \gamma)(y).$$

By Lemma 10.11, the set of functions $\{x \mapsto \varphi(x-k)\}_{k=-\infty}^{\infty}$ is orthonormal. What is not apparent is that they form an orthonormal basis of the same space V_0 and that we thereby obtain a multiresolution analysis and an associated wavelet. The relevant tool is Lemma 10.12, which we have not used explicitly so far.

Theorem 10.25. Let V_j be the closure in $L^2(\mathbb{R})$ of the space of all splines of degree 1 of compact support with knots in $2^{-j}\mathbb{Z}$, let $^1\gamma$ be the B -spline of degree 1 defined above and having Fourier transform as in Corollary 10.22, and let φ be the member of $L^2(\mathbb{R})$ defined by

$$(\mathcal{F}\varphi)(y) = \Delta(y)^{-1/2}(\mathcal{F}^1 \gamma)(y).$$

Then

- (a) the integer translates of φ are in V_0 and form an orthonormal basis of it,
- (b) $\{V_j\}_{j=-\infty}^{\infty}$ and φ constitute a multiresolution analysis,
- (c) the corresponding wavelet ψ may be taken to have Fourier transform $(\mathcal{F}\psi)(y)$ equal to

$$(\sin^2 \frac{1}{2}\pi y) \left(\frac{1 + 2 \sin^2 \frac{1}{2}\pi y}{1 + 2 \cos^2 \pi y} \right)^{1/2} \Delta(\frac{1}{2}y)^{-1/2} (\mathcal{F}^1 \gamma)(\frac{1}{2}y),$$

- (d) the Fourier series $\Delta(y)^{-1/2} = \sum_k d_k e^{-2\pi iky}$ has the property that $\varphi(x)$ is given by $\varphi(x) = \sum_k d_k ^1\gamma(x-k)$, the series being locally a finite sum,
- (e) the Fourier series $\sum_k u_k e^{-\pi iky}$ of period 2 of the function

$$U(y) = (\sin^2 \frac{1}{2}\pi y) \left(\frac{1 + 2 \sin^2 \frac{1}{2}\pi y}{1 + 2 \cos^2 \pi y} \right)^{1/2} \Delta(\frac{1}{2}y)^{-1/2}$$

has the property that $\psi(x)$ is given by $\psi(x) = 2 \sum_k u_k ^1\gamma(2x-k)$, the series being locally a finite sum,

- (f) $\varphi(x)$ and $\psi(x)$ are splines of degree 1 with infinite support, the knots of φ being in \mathbb{Z} and the knots of ψ being in $\frac{1}{2}\mathbb{Z}$,
- (g) $\varphi(x)$ and $\psi(x)$ decay exponentially fast as $|x|$ tends to infinity.

REMARKS. The wavelet obtained from Theorem 10.25 is called the **Battle-Lemarié wavelet** of degree¹⁶ 1. Another name for it is the **Franklin wavelet**. Following Daubechies, we shall refer to the device of using $\Delta(y)$ the way we are using it here as the **orthonormalization trick**. The formulas for φ in (d) and for ψ in (e) allow one to understand φ and ψ without applying \mathcal{F}^{-1} to $\mathcal{F}\varphi$ and $\mathcal{F}\psi$. Graphs of φ and ψ appear in Figure 10.10. To make the graphs, one computes enough Fourier coefficients d_k and u_k numerically to be able to use partial sums of the series in (d) and (e) as good approximations to φ and ψ .

PROOF. For (a), put $\varphi_{0,k}(x) = \varphi(x-k)$. We saw above that the set of functions $\{\varphi_{0,k}\}_{k=-\infty}^{\infty}$ is orthonormal. Let V be the closure of its linear span. We shall use Lemma 10.12 with this V and this φ . Let α and β be as in the statement of that lemma. Let $c = \{c_k\}_{k=-\infty}^{\infty}$ be the sequence of coefficients of the expansion of the function $\Delta(y)^{1/2} = \left(\frac{1}{3}(1 + 2 \cos^2 \pi y)\right)^{1/2}$ in series as $\sum_{k=-\infty}^{\infty} c_k e^{-2\pi iky}$. If f is the member of V given by $f = \alpha(c) = \sum_k c_k \varphi_{0,k}$, then $\beta^{-1}\alpha^{-1}(f) = \Delta^{1/2}$, and Lemma 10.12a shows that $\mathcal{F}f = \Delta^{1/2} \cdot (\mathcal{F}\varphi)$, with the dot indicating pointwise product. The right side equals $\mathcal{F}^1\gamma$, and therefore $f = {}^1\gamma$, i.e.,

$$(\mathcal{F}^1\gamma)(y) = \Delta(y)^{1/2}(\mathcal{F}\varphi)(y). \quad (*)$$

Consequently ${}^1\gamma$ is in V , and the closure V_0 of the space of splines of degree 1 of compact support with knots in \mathbb{Z} is contained in V .

We shall show that equality holds: $V = V_0$. Since $\Delta^{1/2}$ is smooth and is bounded above and below by positive constants, $\Delta^{-1/2}$ is a smooth periodic function on $[0, 1]$. Expand $\Delta(y)^{-1/2}$ in series as $\sum_{k=-\infty}^{\infty} d_k e^{-2\pi iky}$, and let p_n be its n^{th} partial sum. By Proposition 1.56 of *Basic*, $\{p_n\}$ converges uniformly on $[0, 1]$. The limit is $\Delta^{-1/2}$ by Fejér's Theorem (Theorem 1.59 of *Basic*).

We know that the function $\mathcal{F}^{-1}(e^{-2\pi iky}(\mathcal{F}^1\gamma)(y)) = (x \mapsto {}^1\gamma(x-k))$ is in V_0 for each k , and hence so is the linear combination $\mathcal{F}^{-1}(p_n(y)(\mathcal{F}^1\gamma)(y)) = \mathcal{F}^{-1}(p_n(y)\Delta(y)^{1/2}(\mathcal{F}\varphi)(y))$ for each n . The product $p_n\Delta^{1/2}$ converges uniformly to $\Delta^{-1/2}\Delta^{1/2} = 1$, and uniform convergence implies convergence in $L^2[0, 1]$. Lemma 10.12 then allows us to conclude that $p_n(y)\Delta(y)^{1/2}(\mathcal{F}\varphi)(y)$ converges to $(\mathcal{F}\varphi)(y)$ in $L^2(\mathbb{R})$. Applying \mathcal{F}^{-1} , we see that there is a sequence in V_0 converging to φ . Since V_0 is closed, φ is in V_0 , and it follows that $V = V_0$.

¹⁶Terminology varies. Some authors use the word "order" in place of "degree." Some authors shift the indices by 1, saying that the case here is of order 2; for such authors the Haar wavelet becomes the Battle-Lemarié wavelet of order 1.

For (b), we have just seen that the closed subspace of $L^2(\mathbb{R})$ generated by the integer translates of φ is V_0 , and we know for this explicit V_0 that the dilates V_j form an increasing sequence. Propositions 10.15 and 10.17 show that φ is a scaling function, since $\mathcal{F}\varphi$ is continuous, is bounded, and has $(\mathcal{F}\varphi)(0) \neq 0$. Thus $\{V_j\}_{j=-\infty}^{\infty}$ and φ constitute a multiresolution analysis.

For (c), we are to compute ψ . The Fourier transform of the scaling equation for φ gives us $(\mathcal{F}\varphi)(y) = m_0(y/2)(\mathcal{F}\varphi)(y/2)$, from which we have

$$\begin{aligned} m_0(y/2) &= \frac{(\mathcal{F}\varphi)(y)}{(\mathcal{F}\varphi)(y/2)} \\ &= \frac{\left(\frac{1}{3}(1 + 2 \cos^2 \pi y)\right)^{-1/2} (\mathcal{F}^1 \gamma)(y)}{\left(\frac{1}{3}(1 + 2 \cos^2 \pi y/2)\right)^{-1/2} (\mathcal{F}^1 \gamma)(y/2)} \\ &= \frac{\left(\frac{1}{3}(1 + 2 \cos^2 \pi y/2)\right)^{1/2} e^{-2\pi i y} (\pi y)^{-2} \sin^2 \pi y}{\left(\frac{1}{3}(1 + 2 \cos^2 \pi y)\right)^{1/2} e^{-\pi i y} (\pi y/2)^{-2} \sin^2 \pi y/2} \\ &= e^{-\pi i y} \left(\frac{1 + 2 \cos^2 \pi y/2}{1 + 2 \cos^2 \pi y}\right)^{1/2} \cos^2 \pi y/2. \end{aligned}$$

From Theorem 10.10 we may take ψ to have

$$\begin{aligned} (\mathcal{F}\psi)(y) &= e^{\pi i y} \nu(y) \overline{m_0\left(\frac{1}{2}y + \frac{1}{2}\right)} (\mathcal{F}\varphi)\left(\frac{1}{2}y\right) \\ &= -e^{2\pi i y} \nu(y) \sin^2 \frac{1}{2} \pi y \left(\frac{1 + 2 \sin^2 \frac{1}{2} \pi y}{1 + 2 \cos^2 \pi y}\right)^{1/2} (\mathcal{F}\varphi)\left(\frac{1}{2}y\right) \\ &= -e^{2\pi i y} \nu(y) \sin^2 \frac{1}{2} \pi y \left(\frac{1 + 2 \sin^2 \frac{1}{2} \pi y}{1 + 2 \cos^2 \pi y}\right)^{1/2} \Delta\left(\frac{1}{2}y\right)^{-1/2} (\mathcal{F}^1 \gamma)\left(\frac{1}{2}y\right) \end{aligned}$$

with ν periodic of period 1. If we take $\nu(y) = -e^{-2\pi i y}$, then the asserted formula follows.

For (d), we observe that $\mathcal{F}^{-1}(e^{-2\pi i k y} (\mathcal{F}^1 \gamma)(y)) = \gamma(y - k)$ and hence that $\mathcal{F}^{-1}\left(\sum_{k=-n}^n d_k e^{-2\pi i k y} (\mathcal{F}^1 \gamma)(y)\right) = \sum_{k=-n}^n d_k \gamma(x - k)$. That is,

$$\mathcal{F}^{-1}(p_n \Delta^{1/2} \mathcal{F}\varphi) = \sum_{k=-n}^n d_k \gamma(x - k). \quad (**)$$

We saw in the proof of (a) that $p_n \Delta^{1/2} \mathcal{F}\varphi$ converges in $L^2(\mathbb{R})$ to $\mathcal{F}\varphi$. By continuity of \mathcal{F}^{-1} on $L^2(\mathbb{R})$, the left side of (**) converges to φ in $L^2(\mathbb{R})$. Therefore

$$\varphi(x) = \lim_n \sum_{k=-n}^n d_k \gamma(x - k), \quad (\dagger)$$

the limit taken in $L^2(\mathbb{R})$. This proves the equality in (d). Since ${}^1\gamma$ has compact support, the series in (†) is locally the finite sum of continuous functions. Therefore the equality (†) is meaningful pointwise, as well as in $L^2(\mathbb{R})$, if we redefine φ on a set of measure 0 so that it coincides with the pointwise sum.

For (e), let ${}^1\gamma_{1,k}(x) = \sqrt{2}{}^1\gamma(2x - k)$. Changes of variables show that

$$(\mathcal{F}{}^1\gamma_{1,k})(y) = \frac{1}{\sqrt{2}}e^{-\piiky}(\mathcal{F}{}^1\gamma)(\frac{1}{2}y). \quad (\dagger\dagger)$$

Without any justification of interchanges of limits, the argument for (e) is that

$$\begin{aligned} (\mathcal{F}\psi)(y) &= U(y)(\mathcal{F}{}^1\gamma)(\frac{1}{2}y) \\ &= \sum_{k=-\infty}^{\infty} u_k e^{-\piiky} (\mathcal{F}{}^1\gamma)(\frac{1}{2}y) \\ &= \sqrt{2} \sum_{k=-\infty}^{\infty} u_k (\mathcal{F}{}^1\gamma_{1,k})(y) \\ &= \mathcal{F}(\sqrt{2} \sum_{k=-\infty}^{\infty} u_k {}^1\gamma_{1,k})(y). \end{aligned} \quad (\ddagger)$$

Application of \mathcal{F}^{-1} then gives

$$\psi(x) = \sqrt{2} \sum_{k=-\infty}^{\infty} u_k {}^1\gamma_{1,k}(x) = 2 \sum_{k=-\infty}^{\infty} u_k {}^1\gamma(2x - k). \quad (\ddagger\ddagger)$$

We shall interpret (‡‡) as an equality in $L^2(\mathbb{R})$, with convergence in the L^2 sense. With this interpretation the right side is locally a finite sum of continuous functions and hence is continuous. Then the L^2 function ψ can be adjusted on a set of measure 0 so as to agree with this continuous function, and the result is that (‡‡) is also a pointwise equality, the sum being uniformly convergent on each compact subset of \mathbb{R} .

Thus we are to prove (‡‡) in the L^2 sense. Since \mathcal{F} is a unitary operator from $L^2(\mathbb{R})$ onto itself, (‡‡) is immediate from (‡), and we are to justify the steps of (‡). The first equality of (‡) is merely a restatement of conclusion (c) of the theorem, and the third equality follows from (††). For the second equality of (‡), we have substituted the series expansion of $U(y)$, but we have left ambiguous how to interpret this expression in terms of convergence. Is the convergence to be that of periodic functions in $L^2([0, 2])$, or is it to be convergence in $L^2(\mathbb{R})$ of the whole expression? If we were working with φ instead of ${}^1\gamma$, the two would come to the same thing, by Lemma 10.12b, but in our situation we have no comparable

result. Finally the fourth equality of (‡) requires the justification of a clear-cut interchange of limits.

We can handle both difficulties at once if we show that

$$\lim_{n \rightarrow \infty} \left[(\mathcal{F}\psi)(y) - \sum_{|k| \leq n} u_k e^{-\pi i k y} (\mathcal{F}^1 \gamma)\left(\frac{1}{2}y\right) \right] = 0,$$

the convergence being in $L^2(\mathbb{R})$. The computation is

$$\begin{aligned} \left\| \sum_{|k| > n} u_k e^{-i\pi k y} (\mathcal{F}^1 \gamma)\left(\frac{1}{2}y\right) \right\|_{L^2(\mathbb{R})} &= \left\| \sum_{|k| > n} u_k e^{-i\pi k y} \Delta\left(\frac{1}{2}y\right)^{1/2} (\mathcal{F}\varphi)\left(\frac{1}{2}y\right) \right\|_{L^2(\mathbb{R})} \\ &= \left\| \left(\sum_{|k| > n} u_k e^{-i\pi k y} \right) \Delta\left(\frac{1}{2}y\right)^{1/2} \right\|_{L^2([0,2])} \end{aligned}$$

by Lemma 10.12b applied to the space V_1 and the function $\varphi_{1,0}$, with the understanding that the measure on $L^2([0, 2])$ is normalized so as to have total mass 1. The right side is

$$\leq \left(\sup_{0 \leq y \leq 2} \Delta\left(\frac{1}{2}y\right)^{1/2} \right) \left\| \sum_{|k| > n} u_k e^{-i\pi k y} \right\|_{L^2([0,2])},$$

and this tends to 0 as n tends to infinity, since $\Delta(\frac{1}{2}y)^{1/2}$ is bounded and $\sum_k |u_k|^2$ is finite. This completes the proof of (e).

For (f), the fact that each series is locally finite implies that we can differentiate term by term away from the knots. The second derivatives are zero, while the functions themselves are continuous. Thus $\varphi(x)$ and $\psi(x)$ are splines of degree 1. Their support is infinite since ${}^1\gamma$ has compact support and since arbitrarily large translates of it are involved.

For (g), the idea is that the coefficients d_k and u_k decrease geometrically fast, while ${}^1\gamma$ has compact support. The reason for the geometric decrease of the two sequences of Fourier coefficients is that the functions in question are the restrictions to the unit circle of analytic functions in a neighborhood within \mathbb{C} of the unit circle. By Theorem B.47 of Appendix B of *Basic*, these analytic functions each have Laurent series expansions valid within an open annulus that contains the unit circle, and the usual estimates on Taylor coefficients imply that the Fourier coefficients decrease geometrically fast. \square

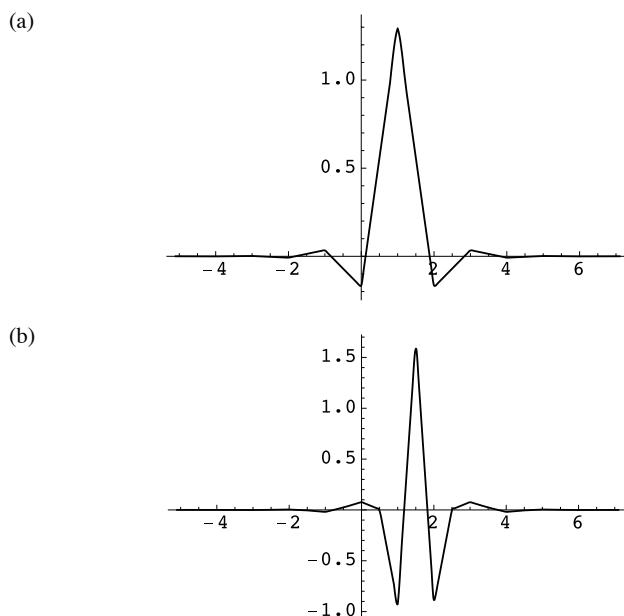

FIGURE 10.10. Graphs of Battle–Lemarié scaling function and wavelet of degree 1. (a) Scaling function. (b) Wavelet.

8. Battle–Lemarié Wavelets

In Section 7 we saw how splines of degree 1 of compact support with knots in \mathbb{Z} lead to a multiresolution analysis and a wavelet. The wavelet is known as the Battle–Lemarié wavelet of degree 1. In more detail the B -splines of degree 1 with knots in \mathbb{Z} are exactly the integer translates of one of them, which we called ${}^1\gamma$, and they form a vector space basis of the space of all splines of degree 1 of compact support with knots in \mathbb{Z} . The closure of this vector space is the space V_0 of the analysis. Unfortunately the B -splines are not orthogonal to one another, and an additional step was necessary to fit everything into our standard set-up.

In this section we shall consider the case of higher degree. The principles will all be the same, but the technical details are more complicated. Before we begin, let us pause to realize that this theory also works in degree 0. In this case the splines in question are functions that are constant between consecutive integers and have compact support, and the B -splines are the integer translates of the Haar scaling function. When we follow through the construction, we arrive at the Haar wavelet. The complication from nonorthogonal B -splines does not arise.

Now we pass to degree m with $m \geq 1$. The first step is to exhibit a nonzero spline of degree m with compact support and with knots in \mathbb{Z} . Specifically we seek an analog of the B -spline ${}^1\gamma$. When $m = 2$, an analog is

$${}^2\gamma(x) = \begin{cases} \frac{1}{2}x^2 & \text{for } 0 \leq x \leq 1, \\ \frac{3}{4} - (x - \frac{3}{2})^2 & \text{for } 1 \leq x \leq 2, \\ \frac{1}{2}(x - 3)^2 & \text{for } 2 \leq x \leq 3, \\ 0 & \text{otherwise.} \end{cases}$$

One readily checks that ${}^2\gamma$ and its first derivative are continuous at $x = 0, 1, 2, 3$ and that ${}^2\gamma$ is supported in $[0, 3]$. Thus $\gamma^{(2)}$ is a nonzero spline of degree 2 of compact support with knots in \mathbb{Z} .

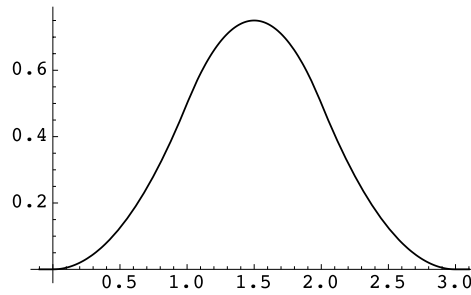
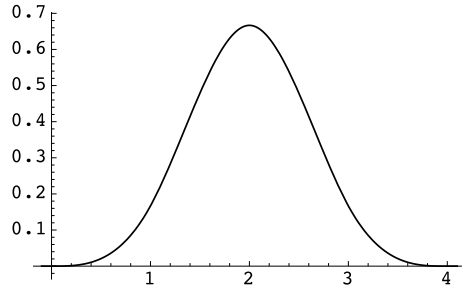

FIGURE 10.11. Graph of the B -spline ${}^2\gamma$.

It is a little hard to see how to generalize the above formula, and a different notation will make matters a little more transparent. Let us introduce the name $(\cdot)_+$ for the function with $t_+ = \max\{0, t\}$. This is a spline of degree 1, and its only knot is in \mathbb{Z} ; but it does not have compact support. The function $(\cdot)_+^m$ with $t_+^m = (\max\{0, t\})^m$ is a spline of degree m . It similarly has its only knot in \mathbb{Z} , and it too fails to have compact support. The integer translates of this function are of the form $(\cdot - k)_+^m$ with $(t - k)_+^m = (\max\{0, t - k\})^m$. We define

$${}^m\gamma(t) = \frac{1}{m!} \sum_{k=0}^{m+1} (-1)^k \binom{m+1}{k} (t - k)_+^m.$$

This formula agrees with the concrete formula for ${}^2\gamma(t)$ given above. Also it agrees with the formula ${}^0\gamma = I_{[0,1]}$ except at integer points.

FIGURE 10.12. Graph of the B -spline ${}^3\gamma$.

The function ${}^m\gamma$ is a spline of degree m with knots in \mathbb{Z} . It is nonzero because if $0 < t < 1$, then ${}^m\gamma(t) = (m!)^{-1}t^m \neq 0$. It is certainly 0 when $t \leq 0$. We shall prove that it is 0 when $t \geq m + 1$. To do so, we make use of the first half of the following combinatorial lemma.

Lemma 10.26.

- (a) For any function $g : \mathbb{R} \rightarrow \mathbb{R}$, write $(\delta g)(x) = g(x) - g(x - 1)$. Then for any $m \geq 1$, $(\delta^m g)(x) = \sum_{k=0}^m (-1)^k \binom{m}{k} g(x - k)$.
- (b) For any function $h : \mathbb{R} \rightarrow \mathbb{R}$, write $(\varepsilon h)(x) = h(x + 1) - h(x)$. Then for any $m \geq 1$, $(\varepsilon^m h)(x) = \sum_{k=0}^m (-1)^{m-k} \binom{m}{k} h(x + k)$.

PROOF. In (a) the argument is for all g by induction on m . The case $m = 1$ is the definition of δg . Assume inductively that equality holds for $m - 1 \geq 1$. Then

$$\begin{aligned}
 \delta^m g(x) &= (\delta^{m-1}(\delta g))(x) \\
 &= \sum_{k=0}^{m-1} (-1)^k \binom{m-1}{k} (\delta g)(x - k) \\
 &= \sum_{k=0}^{m-1} (-1)^k \binom{m-1}{k} g(x - k) - \sum_{k=0}^{m-1} (-1)^k \binom{m-1}{k} g(x - k - 1) \\
 &= \sum_{k=0}^{m-1} (-1)^k \binom{m-1}{k} g(x - k) + \sum_{l=1}^m (-1)^l \binom{m-1}{l-1} g(x - l) \\
 &= \sum_{k=0}^m (-1)^k \binom{m}{k} g(x - k).
 \end{aligned}$$

and the induction is complete. Part (b) follows by applying (a) to the function $g(x) = h(-x)$. \square

Returning to ${}^m\gamma$, we use Lemma 10.26 to show that ${}^m\gamma(t) = 0$ for $t \geq m + 1$. If $t \geq m + 1$, then

$${}^m\gamma(t) = \sum_{k=0}^{m+1} (-1)^k \binom{m+1}{k} (t-k)^m$$

Because of Lemma 10.26, we recognize the polynomial on the right side as $\delta^{m+1}(t^m)$. The operation of δ reduces the degree of a polynomial by 1, and hence $\delta^{m+1}(t^m) = 0$. Thus we see that ${}^m\gamma(t) = 0$ for $t \geq m + 1$.

This proves that ${}^m\gamma$ is supported in the interval $[0, m + 1]$. Translating by an integer, we conclude that the vector space of splines of degree m with knots in \mathbb{Z} and with support in $[N, N + m]$ is not 0 for each integer N .

Let us put that result aside for a moment and verify an integral formula for ${}^m\gamma(x)$. In turn the integral formula will allow us to see that the integer translates of ${}^m\gamma(x)$ form a vector-space basis of the space of all splines of degree m of compact support with knots in \mathbb{Z} . Let us write

$$J_0 = I_{[0,1]},$$

where $I_{[0,1]}$ is the indicator function of the interval $[0, 1]$, and let us further define inductively

$$J_m = J_{m-1} * I_{[0,1]} \quad \text{for } m \geq 1.$$

We have defined J_0 to equal ${}^0\gamma = I_{[0,1]}$, and we saw in Proposition 10.21 that J_1 equals ${}^1\gamma$. We are going to extend this result to higher degrees.

Lemma 10.27.

- (a) $J'_l(x) = \delta J_{l-1}(x) = J_{l-1}(x) - J_{l-1}(x-1)$ for $l \geq 1$ as long as $x \notin \mathbb{Z}$ if $l = 1$,
 (b) $\int_{\mathbb{R}} f'(x) J_l(x) dx = \int_{\mathbb{R}} (\varepsilon f)(x) J_{l-1}(x) dx$ for $l \geq 1$ if f is of class C^1 .

PROOF. For (a), we have $J_l(x) = (J_{l-1} * I_{[0,1]})(x) = \int_0^1 J_{l-1}(x-t) dt$. Differentiation under the integral sign gives

$$J'_l(x) = \int_0^1 J'_{l-1}(x-t) dt = -[J_{l-1}(x-t)]_{t=0}^{t=1} = J_{l-1}(x) - J_{l-1}(x-1).$$

For (b), we first suppose that $l \geq 1$. Then the function $f J_l$ is of class C^1 and has compact support. Therefore $0 = \int_{\mathbb{R}} \frac{d}{dx} (f J_l) dx = \int_{\mathbb{R}} f J'_l dx + \int_{\mathbb{R}} f' J_l dx$. Substituting from (a), we obtain

$$\begin{aligned} \int_{\mathbb{R}} f'(x) J_l(x) dx &= - \int_{\mathbb{R}} f(x) J'_l(x) dx \\ &= - \int_{\mathbb{R}} f(x) J_{l-1}(x) dx + \int_{\mathbb{R}} f(x) J_{l-1}(x-1) dx \\ &= - \int_{\mathbb{R}} f(x) J_{l-1}(x) dx + \int_{\mathbb{R}} f(x+1) J_{l-1}(x) dx \\ &= \int_{\mathbb{R}} (\varepsilon f)(x) J_{l-1}(x) dx. \end{aligned}$$

Now suppose that $l = 1$. In this case the function $J_1(x)$ fails to be C^1 at the points $x = 0, 1, 2$. We compute $\int_{\mathbb{R}} \frac{d}{dx}(f J_1) dx$ as $\int_{-1}^0 + \int_0^1 + \int_1^2 + \int_2^3$ and see that it equals $[f J_1]_{x=-1}^0 + [f J_1]_{x=0}^1 + [f J_1]_{x=1}^2 + [f J_1]_{x=2}^3$. Because of the continuity of J_1 at $x = 0, 1, 2$, we still get cancellation and we still have $\int_{\mathbb{R}} \frac{d}{dx}(f J_1) dx = 0$. Thus the above argument extends to be valid for $l = 1$. \square

Proposition 10.28. For $m \geq 1$,

- (a) ${}^m\gamma(x) = J_m(x)$ for $m \geq 0$ as long as $x \notin \mathbb{Z}$ if $m = 0$, and
- (b) $\int_{\mathbb{R}} {}^m\gamma(x) dx = 1$ for $m \geq 0$.

PROOF. For (a), we shall prove equality for each point x_0 . To handle x_0 , we work with the function $g(t) = \frac{(-1)^m}{(m-1)!} (x_0 - t)_+^{m-1}$. For $k \leq m-2$, its k^{th} derivative is the continuous function

$$g^{(k)}(t) = \frac{(-1)^{m-k}}{(m-k-1)!} (x_0 - t)_+^{m-1-k}.$$

For $k = m-1$, the k^{th} derivative for $t \neq x_0$ is

$$g^{(m-1)}(t) = \begin{cases} 1 & \text{for } t > x_0 \\ 0 & \text{for } t < x_0, \end{cases}$$

and it does not exist at $t = x_0$.

We have

$$\begin{aligned} J_m(x_0) &= \int_{\mathbb{R}} J_{m-1}(x_0 - t) I_{[0,1]}(t) dt \\ &= \int_0^1 J_{m-1}(x_0 - t) dt \\ &= \int_{x_0-1}^{x_0} J_{m-1}(s) ds && \text{under } s = x_0 - t \\ &= \int_{t > x_0-1} J_{m-1}(t) dt - \int_{t > x_0} J_{m-1}(t) dt \\ &= \int_{\mathbb{R}} (g^{(m-1)}(t+1) - g^{(m-1)}(t)) J_{m-1} dt \\ &= \int_{\mathbb{R}} (\varepsilon g^{(m-1)})(t) J_{m-1}(t) dt. \end{aligned}$$

From here we can apply Lemma 10.27b recursively. The above expression is

$$\begin{aligned} &= \int_{\mathbb{R}} (\varepsilon^2 g^{(m-2)})(t) J_{m-2}(t) dt \\ &= \dots = \int_{\mathbb{R}} (\varepsilon^{m-1} g^{(1)})(t) J_1(t) dt \\ &= \int_{\mathbb{R}} (\varepsilon^m g)(t) J_0(t) dt \\ &= \int_0^1 (\varepsilon^m g)(t) dt \end{aligned}$$

$$\begin{aligned}
&= \sum_{k=0}^m \frac{(-1)^{m-k}}{(m-1)!} \binom{m}{k} \int_0^1 (x_0 - t - k)_+^{m-1} dt \\
&= \sum_{k=0}^m \frac{(-1)^{m-k}}{(m-1)!} \binom{m}{k} \int_{x_0-k-1}^{x_0-k} s_+^{m-1} ds \\
&= \sum_{k=0}^m \frac{(-1)^{m-k}}{m!} \binom{m}{k} ((x_0 - k)_+^m - (x_0 - k - 1)_+^m) \\
&= \sum_{k=0}^m \frac{(-1)^{m-k}}{m!} \binom{m}{k} (x_0 - k)_+^m + \sum_{l=1}^{m+1} \frac{(-1)^{m-l}}{m!} \binom{m}{l-1} (x_0 - l)_+^m \\
&= \sum_{k=0}^m \frac{(-1)^{m-k}}{m!} \binom{m+1}{k} (x_0 - k)_+^m \\
&= {}^m\gamma(x_0).
\end{aligned}$$

This completes the proof of (a).

For (b), we have $\int_{\mathbb{R}} {}^m\gamma(x) dx = \int_{\mathbb{R}} J_m(x) dx$. The integral over \mathbb{R} of the convolution of two functions is the product of their integrals. Thus $\int_{\mathbb{R}} J_m(x) dx$ is the product of $m+1$ factors of 1. \square

Corollary 10.29. The vector space of splines of degree m with compact support contained in $[0, m]$ and with knots in \mathbb{Z} is 0.

PROOF. We proceed by induction on m . For $m = 1$, a spline of degree 1 with support in $[0, 1]$ and knots in \mathbb{Z} is given for $0 \leq x \leq 1$ by a linear function $s(x)$, and the support condition implies that $s(0) = s(1) = 0$. Then we must have $s = 0$.

Assume the result for degree $m-1 \geq 1$. If $s(x)$ is a spline of degree m with knots in \mathbb{Z} and with support in $[0, m]$, then the derivative $s'(x)$ is a spline of degree $m-1$ with knots in \mathbb{Z} and with support in $[0, m]$. Arguing by contradiction, we may assume that $s(x)$ is not the 0 spline, so that $s'(x)$ is not the 0 spline. Since ${}^{m-1}\gamma$ is a spline of degree $m-1$ with knots in \mathbb{Z} and with support in $[0, m]$, the boxed jump formula in Section 7 shows that $s'(x) - c {}^{m-1}\gamma$ for a suitable constant $c \neq 0$ is a spline of degree $m-1$ with knots in \mathbb{Z} and with support in $[1, m]$. By inductive hypothesis the difference must be 0. Thus $s'(x)$ is the nonzero constant multiple c of ${}^{m-1}\gamma$. However, any spline of compact support that is a derivative has integral over \mathbb{R} equal to 0, and Proposition 10.28b shows that ${}^{m-1}\gamma$ has nonzero integral. We conclude that $s' = 0$, and we have arrived at a contradiction. \square

We write ${}^m\gamma_{0,k}(x) = {}^m\gamma(x-k)$ for the integer translates of the spline ${}^m\gamma$. Each of them is a spline of degree m of compact support with knots in \mathbb{Z} .

Comparison of their supports shows that they are linearly independent. The functions ${}^m\gamma_{0,k}$ are called ***B-splines*** of degree m , the “*B*” short for basis. The following result justifies this terminology.

Corollary 10.30. The *B-splines* of degree m , i.e., the integer translates of ${}^m\gamma$, form a vector-space basis of the space of splines of degree m with compact support and with knots in \mathbb{Z} .

PROOF. We need to prove spanning. Suppose that a given spline $s(x)$ of degree m with knots in \mathbb{Z} is supported in $[M, N]$ with $M \leq N$. Corollary 10.29 shows that $M + m + 1 \leq N$ unless s is the 0 spline. We shall subtract a multiple of a *B-spline* to reduce the support. Since $s(x)$ vanishes for $x < M$ and since $s(x)$ is of class C^{m-1} , $s^{(k)}(M) = 0$ for $k \neq m$. Let us say that $s^{(k)}(x)$ has a jump by c at $x = M$, c possibly being 0. In this case the boxed jump formula shows that $s(x) = (m!)^{-1}c(x - M)^m$ for $M \leq x \leq M + 1$. Consequently $s(x) - c^m\gamma_{0,M}(x)$ is a spline of degree m , and its support is contained in $[M + 1, \max\{M + m + 1, N\}]$, which is contained in $[M + 1, N]$ since $M + m + 1 \leq N$. The support has been reduced, and in finitely many steps we end up with the difference of $s(x)$ and a linear combination of *B-splines* exhibited as supported in the interval $[N - m, N]$. By Corollary 10.29 this difference is 0. In other words, $s(x)$ equals a linear combination of *B-splines*. \square

Corollary 10.31. The Fourier transform of the *B-spline* ${}^m\gamma$ is given by

$$(\mathcal{F}^m\gamma)(y) = e^{-(m+1)\pi iy} \left(\frac{\sin \pi y}{\pi y} \right)^{m+1}.$$

PROOF. The Fourier transform of a convolution is the product of the Fourier transforms, by Proposition 8.1c of *Basic*. Thus the result follows by combining Propositions 10.20 and 10.28a. \square

In our effort to generalize Theorem 10.25 to higher order splines, we are up to the stage of testing the *B-splines* for the extent to which they are orthonormal. Two *B-splines* with overlapping support are certainly not orthogonal, but we calculate the sum

$$\Delta_{2m}(y) = \sum_{l=-\infty}^{\infty} |(\mathcal{F}^m\gamma)(y + l)|^2$$

anyway. As before, this is a periodic function of period 1. Once again we combine Corollary 10.22 with the appropriate case of Corollary 10.24. Then

$$\begin{aligned}
\Delta_{2m}(y) &= \sum_{l=-\infty}^{\infty} |(\mathcal{F}^m \gamma)(y+l)|^2 = \sum_{l=-\infty}^{\infty} \left| \frac{\sin \pi(y+l)}{\pi(y+l)} \right|^{2m+2} \\
&= \frac{\sin^{2m+2}(\pi y)}{\pi^{2m+2}} \sum_{l=-\infty}^{\infty} \frac{1}{(y+l)^{2m+2}} \\
&= \frac{\sin^{2m+2}(\pi y)}{(2m+1)! \pi^{2m+2}} \frac{d^{2m}}{dy^{2m}} \left(\frac{\pi^2}{\sin^2 \pi y} \right).
\end{aligned}$$

The values of $\Delta_{2m}(y)$ for $1 \leq m \leq 4$ appear as a table in Figure 10.13. We shall be ready to state a generalization of Theorem 10.25 once we prove the following lemma.

Lemma 10.32. For each $m \geq 1$, the function

$$\Delta_{2m}(y) = \frac{\sin^{2m+2}(\pi y)}{(2m+1)! \pi^{2m+2}} \frac{d^{2m}}{dy^{2m}} \left(\frac{\pi^2}{\sin^2 \pi y} \right)$$

is a polynomial in $\sin \pi y$ and $\cos \pi y$ with $P_{2m}(y) > 0$ for all real y .

PROOF. Let $q(y)$ be any polynomial in $\sin \pi y$ and $\cos \pi y$. The formula

$$\frac{d}{dy} \left(\frac{q(y)}{\sin^k \pi y} \right) = \frac{q'(y)}{\sin^k \pi y} - \frac{kq(y) \cos \pi y}{\sin^{k+1} \pi y} = \frac{q'(y) \sin \pi y - kq(y) \cos \pi y}{\sin^{k+1} \pi y}$$

shows that the derivative of a quotient of a polynomial in $\sin \pi y$ and $\cos \pi y$ by a power of $\sin \pi y$ is the quotient of a polynomial in $\sin \pi y$ and $\cos \pi y$ by one higher power of $\sin \pi y$. Consequently the expression $\Delta_{2m}(y)$ in the statement of the lemma is indeed a polynomial in $\sin \pi y$ and $\cos \pi y$.

The computation before the lemma shows that

$$(2m+1)! \pi^{2m} \Delta_{2m}(y) = (2m+1)! \pi^{2m} \sum_{l=-\infty}^{\infty} \left| \frac{\sin \pi(y+l)}{\pi(y+l)} \right|^{2m+2}.$$

The expression on the right side can vanish only if $\sin \pi(y+l) = 0$ for all l , hence only if y is an integer. By periodicity we have only to examine $y = 0$. There the quotient $\sin(\pi y)/(\pi y)$ is not 0. So $\Delta_{2m}(y)$ is positive for all y . \square

m	$\Delta_{2m}(y)$
1	$\frac{1}{3}(2 + 2 \cos 2\pi y)$
2	$\frac{1}{60}(33 + 26 \cos 2\pi y + \cos 4\pi y)$
3	$\frac{1}{2520}(1208 + 1191 \cos 2\pi y + 120 \cos 4\pi y + \cos 6\pi y)$
4	$\frac{1}{2835}(62 + 1072 \cos^2 \pi y + 1452 \cos^4 \pi y + 247 \cos^6 \pi y + 2 \cos^8 \pi y)$

FIGURE 10.13. Values of $\Delta_{2m}(y)$ for small m .

Theorem 10.33. For $m \geq 1$, define

$$\Delta_{2m}(y) = \sum_{l=-\infty}^{\infty} |(\mathcal{F}^m \gamma)(y+l)|^2.$$

Let V_j be the closure in $L^2(\mathbb{R})$ of the space of all splines of degree m of compact support with knots in $2^{-j}\mathbb{Z}$, let ${}^m\gamma$ be the B -spline of degree m defined above and having Fourier transform as in Corollary 10.22, and let φ be the member of $L^2(\mathbb{R})$ defined by

$$(\mathcal{F}\varphi)(y) = \Delta_{2m}(y)^{-1/2}(\mathcal{F}^m \gamma)(y).$$

Then

- (a) the integer translates of φ are in V_0 and form an orthonormal basis of it,
- (b) $\{V_j\}_{j=-\infty}^{\infty}$ and φ constitute a multiresolution analysis,
- (c) the corresponding wavelet ψ may be taken to have Fourier transform $(\mathcal{F}\psi)(y)$ equal to

$$s(y)(\sin^{m+1} \frac{1}{2}\pi y) \left(\frac{\Delta_{2m}(\frac{1}{2}y + \frac{1}{2})}{\Delta_{2m}(y+1)} \right)^{1/2} \Delta_{2m}(\frac{1}{2}y)^{-1/2} (\mathcal{F}^1 \gamma)(\frac{1}{2}y),$$

where $s(y)$ is 1 if m is odd and is $e^{\pi iy}$ if m is even,

- (d) the Fourier series $\Delta_{2m}(y)^{-1/2} = \sum_k d_k e^{-2\pi iky}$ has the property that $\varphi(x)$ is given by $\varphi(x) = \sum_k d_k {}^m\gamma(x-k)$, the series being locally a finite sum,
- (e) the Fourier series $\sum_k u_k e^{-\pi iky}$ of period 2 of the function

$$U(y) = s(y)(\sin^{m+1} \frac{1}{2}\pi y) \left(\frac{\Delta_{2m}(\frac{1}{2}y + \frac{1}{2})}{\Delta_{2m}(y+1)} \right)^{1/2} \Delta_{2m}(\frac{1}{2}y)^{-1/2}$$

has the property that $\psi(x)$ is given by $\psi(x) = 2 \sum_k u_k {}^m\gamma(2x-k)$, the series being locally a finite sum,

- (f) $\varphi(x)$ and $\psi(x)$ are splines of degree m with infinite support, the knots of φ being in \mathbb{Z} and the knots of ψ being in $\frac{1}{2}\mathbb{Z}$,
- (g) $\varphi(x)$ and $\psi(x)$ decay exponentially fast as $|x|$ tends to infinity.

REMARK. The wavelet obtained from Theorem 10.33 is called the **Battle–Lemarié wavelet** of degree¹⁷ m . See Figures 10.14 and 10.15 for graphs of φ and ψ in the cases $m = 2$ and $m = 3$.

¹⁷As was mentioned in connection with Theorem 10.25, terminology varies. Some authors use the word “order” in place of “degree.” Some authors shift the indices by 1, saying that the case here is of order $m + 1$.

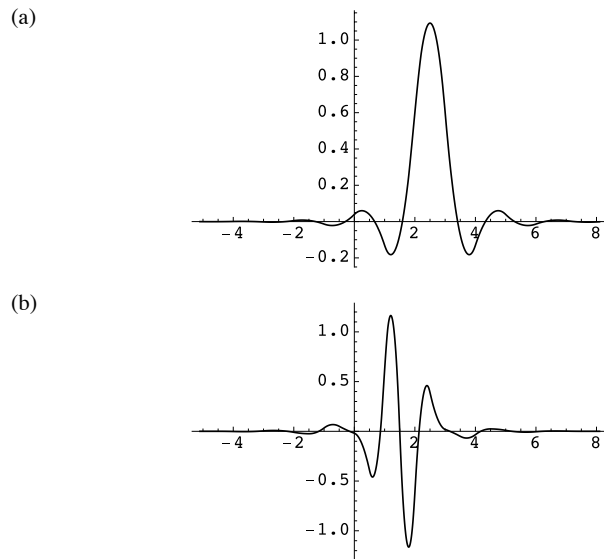

FIGURE 10.14. Graphs of Battle–Lemarié scaling function and wavelet of degree 2. (a) Scaling function. (b) Wavelet.

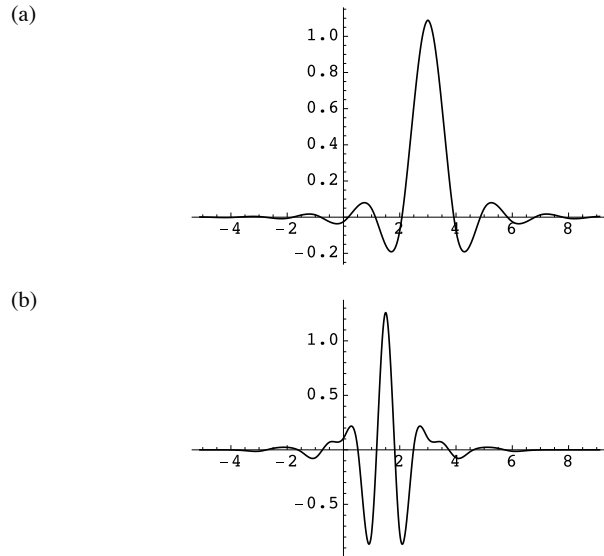

FIGURE 10.15. Graphs of Battle–Lemarié scaling function and wavelet of degree 3. (a) Scaling function. (b) Wavelet.

PROOF. Lemma 10.32 shows that $P_{2m}(y)$ is a polynomial in $\sin \pi y$ and $\cos \pi y$ that is everywhere positive. Being a continuous periodic function that is everywhere positive, $\Delta_{2m}(y)$ is bounded above and below by positive constants. We can therefore use the orthonormalization trick introduced in the proof of Theorem 10.25 to show that the integer translates of φ form an orthonormal set.

For (a), we define $\varphi_{0,k}(x) = \varphi(x - k)$, and let V be the closure of its linear span. We use Lemma 10.12 to argue as in Theorem 10.25a that $V = V_0$.

For (b) we use Propositions 10.15 and 10.17 just as in the proof of Theorem 10.25b to complete the argument that $\{\varphi_j\}_{j=-\infty}^{\infty}$ and φ constitute a multiresolution analysis.

For (c) we have to compute ψ . The Fourier transform of the scaling equation gives us $(\mathcal{F}\psi)(y) = m_0(y/2)(\mathcal{F}\varphi)(y/2)$, from which we have

$$\begin{aligned} m_0(y/2) &= \frac{(\mathcal{F}\varphi)(y)}{(\mathcal{F}\varphi)(y/2)} \\ &= \frac{\Delta_{2m}(y)^{-1/2}(\mathcal{F}^1\gamma)(y)}{\Delta_{2m}(y/2)^{-1/2}(\mathcal{F}^1\gamma)(y/2)} \\ &= \frac{\Delta_{2m}(y)^{-1/2}e^{-(m+1)\pi iy}(\pi y)^{-(m+1)}\sin^{m+1}\pi y}{\Delta_{2m}(y/2)^{-1/2}e^{-\frac{1}{2}(m+1)\pi iy}(\pi y/2)^{-(m+1)}\sin^{m+1}\pi y/2} \\ &= e^{-\frac{1}{2}(m+1)\pi iy}\left(\frac{\Delta_{2m}(\frac{1}{2}y)}{\Delta_{2m}(y)}\right)^{1/2}\cos^{m+1}\frac{1}{2}\pi y. \end{aligned}$$

From Theorem 10.10 we may take

$$\begin{aligned} (\mathcal{F}\psi)(y) &= e^{\pi iy}v(\frac{1}{2}y)\overline{m_0(\frac{1}{2}y + \frac{1}{2})}(\mathcal{F}\varphi)(\frac{1}{2}y) \\ &= e^{\pi iy}v(\frac{1}{2}y)e^{\frac{1}{2}(m+1)\pi iy}e^{\frac{1}{4}\pi i(m+1)} \\ &\quad \times (\sin^{m+1}\frac{1}{2}\pi y)\left(\frac{\Delta_{2m}(\frac{1}{2}y + \frac{1}{2})}{\Delta_{2m}(y + 1)}\right)^{1/2}(\mathcal{F}\varphi)(\frac{1}{2}y) \\ &= v(\frac{1}{2}y)e^{\frac{1}{2}(m+3)\pi iy}e^{\frac{1}{4}(m+1)\pi i} \\ &\quad \times (\sin^{m+1}\frac{1}{2}\pi y)\left(\frac{\Delta_{2m}(\frac{1}{2}y + \frac{1}{2})}{\Delta_{2m}(y + 1)}\right)^{1/2}\Delta_{2m}(\frac{1}{2}y)^{-1/2}(\mathcal{F}^m\gamma)(\frac{1}{2}y). \end{aligned}$$

with v periodic of period 1. If we take

$$v(y) = \begin{cases} e^{-\frac{1}{4}(m+1)\pi i}e^{-(m+3)\pi iy} & \text{if } m \text{ is odd} \\ e^{-\frac{1}{4}(m+1)\pi i}e^{-(m+2)\pi iy} & \text{if } m \text{ is even,} \end{cases}$$

then

$$\nu\left(\frac{1}{2}y\right)e^{\frac{1}{2}(m+3)\pi iy}e^{\frac{1}{4}(m+1)\pi i} = \begin{cases} 1 & \text{if } m \text{ is odd} \\ e^{\pi iy} & \text{if } m \text{ is even,} \end{cases}$$

and (c) follows.

The proofs of (d) through (g) are straightforward adaptations of the corresponding arguments within the proof of Theorem 10.25. \square

9. Daubechies Wavelets

Recall that the Haar wavelet has the desirable property of having compact support and the undesirable property of being discontinuous. Studying the Haar wavelet in the context of the general theory of wavelets leads one naturally to the question whether there are continuous wavelets of compact support. The existence of the Daubechies wavelets, as established in this section, gives an affirmative answer to this question.

Indeed, the compactness of their supports is such a helpful property that the Daubechies wavelets are the ones used in many applications. Although the general method used in their construction allows for many alternative formulations, their usual definitions include just one wavelet for each positive integer N , which is called the **order**. The order of a Daubechies wavelet is one more than the degree of a certain polynomial used in the definition of the scaling function, and it is half the number of nonzero coefficients of the generating function¹⁸ m_0 . It is related to the order of differentiability of the wavelet in a complicated way that will be discussed in part in the next section. The Daubechies wavelet of order 1 is the Haar wavelet. All Daubechies wavelets of higher order are continuous. Unlike with the Meyer wavelets, there is no Daubechies wavelet of infinite order; we shall see in the next section that no compactly supported wavelet of class C^∞ exists.

No closed form is known for the definition of the Daubechies wavelets of order greater than 1. They are constructed within the context of a multiresolution analysis by a limiting process.

The starting point for the construction is the scaling equation, specifically the generating function m_0 that appears in the scaling equation. Recall that the scaling equation is of the form

$$\varphi(x) = \sum_{k=-\infty}^{\infty} a_k \sqrt{2} \varphi(2x - k)$$

¹⁸The function m_0 is sometimes called the **scaling filter** or **low-pass filter**, but its role as a filter will not be part of our discussion until Section 11.

for constants $a_k = \int_{\mathbb{R}} \sqrt{2} \varphi(x) \overline{\varphi(2x - k)} dx$ with $\sum |a_k|^2 = 1$ and that the associated generating function is given by

$$m_0(y) = \frac{1}{\sqrt{2}} \sum_{k=-\infty}^{\infty} a_k e^{-2\pi i k y}.$$

If φ has compact support, then a_k can be nonzero for only finitely many k , and hence $m_0(y)$ is a trigonometric polynomial.¹⁹ Following the Daubechies approach, we wish to arrange that *the scaling function φ is real-valued and has compact support*. The inner product formula for the coefficients a_k then shows that a_k is real for all k .

The wavelet is given by a similar equation, the wavelet equation, with coefficients b_k related to the a_k 's. As a consequence only finitely many b_k 's will be nonzero, and thus we see that having φ of compact support forces the wavelet ψ to have compact support.

Before beginning the construction, let us peek ahead and see that the compactly supported scaling function φ must have $|(\mathcal{F}\varphi)(0)| = 1$. (In particular, φ must have nonzero integral over \mathbb{R} .) Since φ is to be a scaling function for a multiresolution analysis, the integer translates of φ are to form an orthonormal set. The closed linear span of the integer translates will be the space V_0 , and we form spaces V_j as usual. The intersection of the V_j 's is 0 automatically, according to Proposition 10.15. But when the V_j are increasing, it is not automatic that their union is dense in $L^2(\mathbb{R})$. Proposition 10.17 gives a sufficient condition, namely that $\mathcal{F}\varphi$ is a bounded function that is continuous and nonzero at $y = 0$.

Since φ is in $L^2(\mathbb{R})$ and has compact support, it has to be in $L^1(\mathbb{R})$ and its Fourier transform $\mathcal{F}\varphi$ has to be bounded and continuous. But what about the condition $(\mathcal{F}\varphi)(0) \neq 0$? Let us see that the union of the V_j 's will actually fail to be dense in $L^2(\mathbb{R})$ unless $|(\mathcal{F}\varphi)(0)| = 1$. In fact, let f be any nonzero member of $L^2(\mathbb{R})$ whose Fourier transform is bounded and is compactly supported, say in the interval $[-M, M]$. If P_j is the orthogonal projection on V_j , then Lemma 10.16 gives

$$\|P_j f\|_2^2 = \int_{-M}^M |(\mathcal{F}f)(y)|^2 |(\mathcal{F}\varphi)(2^{-j}y)|^2 dy$$

when j is large enough so that $2^{j-1} > M$. The integrand is bounded by a multiple of $|(\mathcal{F}f)(y)|^2$, and dominated convergence gives us

$$\begin{aligned} \lim_{j \rightarrow \infty} \|P_j f\|_2^2 &= \int_{-M}^M |(\mathcal{F}f)|^2 |(\mathcal{F}\varphi)(0)|^2 dy \\ &= |(\mathcal{F}\varphi)(0)|^2 \|\mathcal{F}f\|_2^2 = |(\mathcal{F}\varphi)(0)|^2 \|f\|_2^2. \end{aligned}$$

¹⁹A **trigonometric polynomial** is defined for current purposes to be a polynomial in $e^{2\pi i y}$ and $e^{-2\pi i y}$.

If $\bigcup_j V_j$ is dense in $L^2(\mathbb{R})$, then the left side equals $\|f\|_2^2$, which we are assuming is nonzero. Then it follows that $|(\mathcal{F}\varphi)(0)| = 1$. Hence a φ with compact support cannot yield a multiresolution analysis unless $|(\mathcal{F}\varphi)(0)| = 1$.

We are ready to construct the multiresolution analysis. For each step we shall derive necessary conditions and then either show that those conditions are sufficient or add some additional conditions to make them sufficient. These are the two steps:

- (1) find the possible trigonometric polynomials that might serve as m_0 ,
- (2) find how to determine φ from m_0 , and find conditions on φ so that φ is the scaling function for a multiresolution analysis.

Step 1. In this step we look for m_0 in the form of a trigonometric polynomial. Let us write down conditions that m_0 must satisfy. A first condition is the identity

$$|m_0(y)|^2 + |m_0(y + \frac{1}{2})|^2 = 1$$

given by Lemma 10.13. We do not need to add the words “almost everywhere” because m_0 as a trigonometric polynomial is automatically continuous. We have just seen that we must have $(\mathcal{F}\varphi)(0) \neq 0$. From the Fourier transform of the scaling equation, namely

$$(\mathcal{F}\varphi)(y) = m_0(y/2)(\mathcal{F}\varphi)(y/2),$$

we see that $m_0(0) = 1$. Since $|m_0(0)|^2 + |m_0(\frac{1}{2})|^2 = 1$, we see that $m_0(\frac{1}{2}) = 0$. Then we can write

$$m_0(y) = \left(\frac{1 + e^{-2\pi iy}}{2} \right)^N \mathcal{L}(y)$$

for some trigonometric polynomial $\mathcal{L}(y)$, where $N \geq 1$ is the order of the zero of $m_0(y)$ at $y = \frac{1}{2}$. It will be observed in the proof below that since $m_0(y)$ has real coefficients, so does $\mathcal{L}(y)$. In Propositions 10.34 and 10.36 below, we shall determine all the functions m_0 that satisfy all conditions so far.

Proposition 10.34. Let a trigonometric polynomial $m_0(y)$ with real coefficients be given in the form

$$m_0(y) = \left(\frac{1 + e^{-2\pi iy}}{2} \right)^N \mathcal{L}(y)$$

with $N \geq 1$. If m_0 satisfies the equation $|m_0(y)|^2 + |m_0(y + \frac{1}{2})|^2 = 1$, then the trigonometric polynomial $L(y) = |\mathcal{L}(y)|^2$ can be written as

$$L(y) = P(\sin^2 \pi y)$$

for some ordinary polynomial P of the form

$$P(w) = P_N(w) + w^N R\left(\frac{1}{2} - w\right)$$

with

$$P_N(w) = \sum_{k=0}^{N-1} \binom{N-1+k}{k} w^k$$

and with R an odd ordinary polynomial such that $P(w) \geq 0$ for $0 \leq w \leq 1$. Conversely if the trigonometric polynomial $L(y) = |\mathcal{L}(y)|^2$ with real coefficients can be written as

$$L(y) = P(\sin^2 \pi y)$$

for some ordinary polynomial P of the form

$$P(w) = P_N(w) + w^N R\left(\frac{1}{2} - w\right)$$

with

$$P_N(w) = \sum_{k=0}^{N-1} \binom{N-1+k}{k} w^k$$

and with R an odd ordinary polynomial such that $P(w) \geq 0$ for $0 \leq w \leq 1$, then $m_0(y) = \left(\frac{1 + e^{-2\pi iy}}{2}\right)^N \mathcal{L}(y)$ satisfies the equation $|m_0(y)|^2 + |m_0(y + \frac{1}{2})|^2 = 1$.

REMARKS. What Proposition 10.34 says briefly is that a trigonometric polynomial $m_0(y) = \left(\frac{1}{2}(1 + e^{-2\pi iy})\right)^N \mathcal{L}(y)$ satisfying the functional equation leads us to a certain kind of polynomial P and that that kind of P leads us back to the integer N and the modulus squared $|\mathcal{L}(y)|^2$ of the function that appears in the formula for $m_0(y)$. To get all the way back to $m_0(y)$, rather than merely back to $|m_0(y)|^2$, we need a way of passing from $|\mathcal{L}(y)|^2$ to $\mathcal{L}(y)$. That step is postponed to Proposition 10.36.

To prove Proposition 10.34, we need a lemma.

Lemma 10.35. Let $P_N(w)$ be the polynomial $\sum_{k=0}^{N-1} \binom{2N-1}{k} w^k (1-w)^{N-k-1}$.

Then P_N has the properties

- (a) $P_N(w)(1-w)^N + w^N P_N(1-w) = 1$,
- (b) $P_N(w) = \sum_{k=0}^{N-1} \binom{N-1+k}{k} w^k$,
- (c) $0 \leq P_N(y) \leq P_N(1) = \binom{2N-1}{N}$ for $0 \leq y \leq 1$.

N	Polynomial $P_N(w)$
1	1
2	$1 + 2w$
3	$1 + 3w + 6w^2$
4	$1 + 4w + 10w^2 + 20w^3$
5	$1 + 5w + 15w^2 + 35w^3 + 70w^4$
6	$1 + 6w + 21w^2 + 56w^3 + 126w^4 + 252w^5$
7	$1 + 7w + 28w^2 + 84w^3 + 210w^4 + 462w^5 + 924w^6$

FIGURE 10.16. Table of values of the polynomial $P_N(w)$ used in defining the Daubechies wavelet of order N .

PROOF. The Binomial Theorem gives

$$\begin{aligned}
 1 &= (w + (1 - w))^{2N-1} \\
 &= \sum_{k=0}^{2N-1} \binom{2N-1}{k} w^k (1-w)^{2N-1-k} \\
 &= (1-w)^N \sum_{k=0}^{N-1} \binom{2N-1}{k} w^k (1-w)^{N-1-k} \\
 &\quad + w^N \sum_{k=N}^{2N-1} \binom{2N-1}{k} w^{k-N} (1-w)^{2N-1-k} \\
 &= (1-w)^N P_N(w) + w^N P_N(1-w).
 \end{aligned}$$

This proves (a). For (b) we observe that $Q_N(w) = \sum_{k=0}^{N-1} \binom{N-1+k}{k} w^k$ equals the sum of the terms of the Taylor series of $(1-w)^{-N}$ about $w = 0$ through order $N-1$. From the result of (a),

$$(1-w)^{-N} = P_N(w) + w^N (1-w)^{-N} P_N(1-w).$$

On the other hand, $P_N(w)$ on the right side is a polynomial of degree $N-1$, and the other term on the right side is the product of w^N and an analytic function for $|w| < 1$. Thus $P_N(y) = Q_N(y)$. This proves (b). For (c), we use the result of (b) to see that $0 \leq P_N(y) = \sum_{k=0}^{N-1} \binom{N-1+k}{k} y^k \leq \sum_{k=0}^{N-1} \binom{N-1+k}{k} = P_N(1)$, and $P_N(1) = \binom{2N-1}{N}$ from the definition of $P_N(w)$. This proves (c). \square

PROOF OF NECESSITY IN PROPOSITION 10.34. If a trigonometric polynomial $m(y) = \sum c_k e^{-2\pi iky}$ with real coefficients is divisible by $1 + e^{-2\pi iy}$, say as $m(y) = q(y)(1 + e^{-2\pi iy})$ with $q(y) = \sum d_k e^{-2\pi iky}$ equal to a trigonometric polynomial, then we see that $c_k = d_k + d_{k-1}$ for all k . Since $d_{k-1} = 0$ for some k , it follows that we can recursively determine the coefficients d_k and see that they are real. Iterating this result, we see that the trigonometric polynomial $\mathcal{L}(y)$ in the statement of the proposition has real coefficients.

The function $L(y) = |\mathcal{L}(y)|^2$ is a trigonometric polynomial with real coefficients, say $L(y) = \sum A_k e^{-2\pi iky}$, and it is real valued. Taking its complex conjugate, we see that $A_k = A_{-k}$ for each k , hence that $L(y)$ is a finite linear combination of the functions $\cos 2\pi ky$ with real coefficients. Each $\cos 2\pi ky$ is a polynomial function of $\cos 2\pi y$, and thus $L(y)$ is a polynomial in $\cos 2\pi y$ with real coefficients, say $L(y) = Q(\cos 2\pi y)$.

Consider $|m_0(y)|^2$. This has

$$\begin{aligned} |m_0(y)|^2 &= \left(\frac{1 + e^{-2\pi iy}}{2}\right)^N \left(\frac{1 + e^{2\pi iy}}{2}\right)^N L(y) \\ &= (\cos^2 \pi y)^N Q(\cos 2\pi y). \end{aligned} \quad (*)$$

Since $\sin^2 \pi y = \frac{1}{2}(1 - \cos 2\pi y)$, we can rewrite $Q(\cos 2\pi y)$ as $P(\sin^2 \pi y)$ for a polynomial P with real coefficients. Define a function $w = w(y)$ by $w(y) = \sin^2 \pi y$. Then $1 - w(y) = \cos^2 \pi y$, and (*) becomes

$$|m_0(y)|^2 = (1 - w(y))^N P(w(y)). \quad (**)$$

To work with the corresponding formula for $|m_0(y + \frac{1}{2})|^2$, we need to compute $w(y + \frac{1}{2})$. Observe that $\sin \pi(y + \frac{1}{2}) = \sin \pi y \cos \pi/2 + \cos \pi y \sin \pi/2 = \cos \pi y$. Thus $w(y + \frac{1}{2}) = \sin^2 \pi(y + \frac{1}{2}) = \cos^2 \pi y = 1 - \sin^2 \pi y = 1 - w(y)$, and

$$|m_0(y + \frac{1}{2})|^2 = (1 - w(y + \frac{1}{2}))^N P(w(y + \frac{1}{2})) = (w(y))^N P(1 - w(y)). \quad (\dagger)$$

Adding (**) and (\dagger) gives

$$1 = |m_0(y)|^2 + |m_0(y + \frac{1}{2})|^2 = (1 - w)^N P(w) + w^N P(1 - w). \quad (\dagger\dagger)$$

In view of Lemma 10.35a, we have $1 = (1 - w)^N P_N(w) + w^N P_N(1 - w)$. Subtracting (\dagger\dagger) and this equation gives

$$(1 - w)^N (P(w) - P_N(w)) + w^N (P(1 - w) - P_N(1 - w)) = 0, \quad (\ddagger)$$

from which it follows that w^N divides $P(w) - P_N(w)$.

Let write $P(w) - P_N(w) = w^N R(\frac{1}{2} - w)$ for a polynomial R . Equation (\ddagger) shows that

$$w^N (1 - w)^N R(\frac{1}{2} - w) + w^N (1 - w)^N R(\frac{1}{2} - (1 - w)) = 0.$$

Hence $R(-w) = -R(w)$, and R is odd. \square

PROOF OF SUFFICIENCY IN PROPOSITION 10.34. If $L(y) = |\mathcal{L}(y)|^2$ can be written as $L(y) = P(\sin^2 \pi y)$ with P of the form

$$P(w) = P_N(w) + w^N R\left(\frac{1}{2} - w\right)$$

and R odd, then we use Lemma 10.35a to write

$$P_N(w)(1-w)^N + w^N P_N(1-w) = 1. \quad (\ddagger\ddagger)$$

The oddness of R ensures that

$$w^N R\left(\frac{1}{2} - w\right)(1-w)^N + w^N (1-w)^N R\left(\frac{1}{2} - (1-w)\right) = 0. \quad (\S)$$

Adding $(\ddagger\ddagger)$ and (\S) gives

$$P(w)(1-w)^N + w^N P(1-w) = 1.$$

Substituting $w = \sin^2 \pi y$ shows that

$$P(\sin^2 \pi y)(\cos^2 \pi y)^N + (\sin^2 \pi y)^N P(\cos^2 \pi y) = 1. \quad (\S\S)$$

We saw in $(**)$ that $|m_0(y)|^2 = (1-w)^N P(w)$ and in (\dagger) that $|m_0(y + \frac{1}{2})|^2 = w^N P(1-w)$. Substituting these two relations into $(\S\S)$ gives

$$|m_0(y)|^2 + |m_0(y + \frac{1}{2})|^2 = 1,$$

as required. \square

Proposition 10.36 (Fejér and F. Riesz).²⁰ If $t(y) = \sum_{k=-M}^M c_k e^{-2\pi i k y}$ is a trigonometric polynomial that is everywhere ≥ 0 , then there exists a trigonometric polynomial $\mathcal{L}(y) = \sum_{k=-M}^M d_k e^{-2\pi i k y}$ such that $t(y) = |\mathcal{L}(y)|^2$. If all the c_k are real, then all the d_k can be taken to be real.

REMARKS.

(1) Proposition 10.36 adds to Proposition 10.34 a final step in the inverse direction. Instead of merely passing from a certain kind of polynomial P to the integer N and $|\mathcal{L}(y)|^2$, we can now pass back from P to N and $\mathcal{L}(y)$ itself, therefore to m_0 .

(2) No uniqueness result is asserted in Proposition 10.36. In the construction of $\mathcal{L}(y)$ in the proof below, we do not need to take all the roots α_j inside the unit disk and none of the roots $\bar{\alpha}_j^{-1}$ outside the unit disk. We merely have to select one root from each pair $\alpha_j, \bar{\alpha}_j^{-1}$. If there are r pairs of roots, the total number of possibilities for $\mathcal{L}(y)$ is 2^r .

²⁰The original version appears on page 117 of the book by Riesz and Sz.-Nagy.

PROOF. We may assume that $t(y)$ is not identically 0. Since $t(y)$ is real valued, we have an equality

$$\sum_{k=-M}^M c_{-k} e^{2\pi i k y} = \sum_{k=-M}^M c_k e^{-2\pi i k y} = t(y) = \overline{t(y)} = \sum_{k=-M}^M \overline{c_k} e^{2\pi i k y},$$

and we must have equality term by term. Therefore $c_{-k} = \overline{c_k}$ for all k . We may assume that M is as small as possible, and then $c_{-M} \neq 0$. Define an ordinary polynomial by

$$Q(z) = c_{-M} + \dots + c_M z^{2M} = \overline{c_M} + \dots + \overline{c_{-M}} z^{2M}.$$

Then

$$t(y) = e^{2\pi i M y} Q(e^{-2\pi i y}) \tag{*}$$

and

$$z^{2M} Q(z^{-1}) = \overline{Q(\overline{z})}. \tag{**}$$

From (**) it follows that if $Q(z_0) = 0$ with z_0 outside the closed unit disk, then $Q(1/\overline{z_0}) = 0$ with $1/\overline{z_0}$ inside the unit disk, and vice versa. Furthermore, the multiplicities match. Observe that $Q(z)$ cannot vanish at $z = 0$ because $c_{-M} \neq 0$.

Suppose that $Q(z)$ has a zero at $e^{-2\pi i \theta_0}$ of order m . Then $\theta \mapsto Q(e^{-2\pi i \theta})$ has a zero at $\theta = \theta_0$, and this zero is of the same order m because the exponential function has a locally defined inverse about every point of its image. Similarly $\theta \mapsto e^{2\pi i M \theta} Q(e^{-2\pi i \theta})$ has a zero of order m at $\theta = \theta_0$. This function is real-valued, matching $t(\theta)$ for $\theta \in \mathbb{R}$, and it equals the sum of a multiple of $(\theta - \theta_0)^m$ and a small error term for $|\theta - \theta_0|$ small. Since t takes on no negative values, m has to be even.

All that being so, let $\{\alpha_j\}$ be the zeros of $Q(z)$ inside the open unit disk, repeated according to their multiplicities, and let $\{\beta_k\}$ be the distinct zeros of $Q(z)$ on the unit circle, with β_k having multiplicity $2m_k$. Since a polynomial is determined up to a multiplicative constant by its roots and their multiplicities, we have

$$Q(z) = c \left(\prod_j (z - \alpha_j)(z - (\overline{\alpha_j})^{-1}) \right) \left(\prod_k (z - \beta_k)^{2m_k} \right)$$

and

$$t(y) = c e^{2\pi i M y} \left(\prod_j (e^{-2\pi i y} - \alpha_j)(e^{-2\pi i y} - (\overline{\alpha_j})^{-1}) \right) \left(\prod_k (e^{-2\pi i y} - \beta_k)^{2m_k} \right).$$

Put

$$r(y) = \left(\prod_j (e^{-2\pi i y} - \alpha_j) \right) \left(\prod_k (e^{-2\pi i y} - \beta_k)^{m_k} \right).$$

Then

$$|r(y)|^2 = \left(\prod_j |e^{-2\pi iy} - \alpha_j|^2 \right) \left(\prod_k |e^{-2\pi iy} - \beta_k|^{2m_k} \right)$$

Now

$$\begin{aligned} |e^{-2\pi iy} - \alpha_j|^2 &= (e^{-2\pi iy} - \alpha_j)(e^{2\pi iy} - \overline{\alpha_j}) \\ &= -e^{2\pi iy} \overline{\alpha_j} (e^{-2\pi iy} - \alpha_j) (e^{-2\pi iy} - (\overline{\alpha_j})^{-1}) \end{aligned}$$

and

$$|e^{-2\pi iy} - \beta_k|^2 = (e^{-2\pi iy} - \beta_k)(e^{2\pi iy} - \overline{\beta_k}) = -\overline{\beta_k} e^{2\pi iy} (e^{-2\pi iy} - \beta_k)^2.$$

Comparing, we see that there is some integer p with

$$|r(y)|^2 = c' e^{2\pi i p y} t(y) \quad \text{and with } c' \text{ in } \mathbb{C}.$$

Since $|r(y)|^2$ and $t(y)$ are nonnegative and not identically 0, we see that c' is positive and that $p = 0$. Putting $\mathcal{L}(y) = r(y)\sqrt{c'}^{-1}$, we obtain a trigonometric polynomial whose absolute value squared equals $t(y)$.

If all the c_k are real, then $Q(z)$ has real coefficients and its roots come in complex conjugate pairs. If α_j used in the definition of $r(y)$, then we use $\overline{\alpha_j}$ also, with the same multiplicity. Then the result is that $r(y)$ has real coefficients, and so does $\mathcal{L}(y)$. \square

Step 2. In this step we determine φ from m_0 . We start from the Fourier transform of the scaling equation,

$$(\mathcal{F}\varphi)(y) = m_0(y/2)(\mathcal{F}\varphi)(y/2).$$

We know from earlier that $m_0(0) = 1$, that $m_0(\frac{1}{2}) = 0$, and that m_0 is a trigonometric polynomial periodic of period 1. If we iterate the formula, we obtain

$$(\mathcal{F}\varphi)(y) = \left(\prod_{j=1}^n m_0(2^{-j}y) \right) (\mathcal{F}\varphi)(2^{-n}y).$$

Proposition 10.37. If φ is a compactly supported scaling function, then the infinite product

$$\prod_{j=1}^n m_0(2^{-j}y)$$

converges (to a limit that is nonzero at points where all the factors are nonzero), the convergence being uniform on compact sets in \mathbb{R} , and

$$(\mathcal{F}\varphi)(y) = \left(\prod_{j=1}^{\infty} m_0(2^{-j}y) \right) (\mathcal{F}\varphi)(0)$$

with $|(\mathcal{F}\varphi)(0)| = 1$.

PROOF. Fix $M > 0$. We prove uniform convergence for $|y| \leq M$. By Taylor's Theorem, $|m_0(y) - 1| \leq C|y|$ for $|y| \leq M$, say. Then also $|m_0(2^{-j}y) - 1| \leq C2^{-j}M$. Since $\sum_{j=1}^{\infty} C2^{-j}M$ converges, the given infinite product converges as asserted.²¹ Therefore

$$(\mathcal{F}\varphi)(y) = \left(\prod_{j=1}^{\infty} m_0(2^{-j}y) \right) \left(\lim_{n \rightarrow \infty} (\mathcal{F}\varphi)(2^{-n}y) \right).$$

The second factor on the right equals $(\mathcal{F}\varphi)(0)$ since the Fourier transform of the L^1 function φ is continuous, and we have seen that $|(\mathcal{F}\varphi)(0)| = 1$. \square

Now let us consider the converse direction, to pass from m_0 to φ . We need to remember that we are seeking a real-valued φ . Then $(\mathcal{F}\varphi)(0)$, being the integral of φ , must be real, and so we must have $(\mathcal{F}\varphi)(0) = \pm 1$. This minus sign is harmless, and we might as well aim for $(\mathcal{F}\varphi)(0) = 1$ and define $\mathcal{F}\varphi$ by the product formula in the proposition:

$$(\mathcal{F}\varphi)(y) = \prod_{j=1}^{\infty} m_0(2^{-j}y).$$

Sadly if we start from m_0 produced from Step 1 and we define φ this way, the result is not necessarily a scaling function: the set of its integer translates can fail to be orthonormal. We need an extra assumption. A necessary and sufficient condition is known, but we shall not give it. Instead we give a sufficient condition that we can easily verify in the examples of interest.

Proposition 10.38. Suppose that $m_0(y)$ is a trigonometric polynomial such that

- (i) $m_0(0) = 1$,
- (ii) $|m_0(y)|^2 + |m_0(y + \frac{1}{2})|^2 = 1$, and
- (iii) $m_0(y)$ is nonzero for $|y| \leq \frac{1}{4}$.

Define

$$h(y) = \prod_{j=1}^{\infty} m_0(2^{-j}y).$$

Then the infinite product converges uniformly on compact sets of \mathbb{R} , and the limit function h is a smooth function in $L^2(\mathbb{R})$ with $h(0) = 1$. Moreover the inverse Fourier transform $\varphi = \mathcal{F}^{-1}h$ has compact support, has the property that its integer translates are orthonormal, and satisfies the scaling equation $(\mathcal{F}\varphi)(y) = m_0(y/2)(\mathcal{F}\varphi)(y/2)$. Consequently φ is the scaling function for a multiresolution analysis. If $m_0(y)$ has real coefficients, then φ is real-valued.

²¹For a proof of the standard facts relating convergence of infinite series with convergence of infinite products, see the author's *Elliptic Curves*, page 195. For the uniformity of the convergence, we are incorporating the Weierstrass M test into the relevant theorem.

PROOF. For the moment let us regard the variable y as complex. Observe that $m_0(y)$ is a trigonometric polynomial and is therefore entire. We check that the product defining $h(y)$ converges uniformly on compact subsets of \mathbb{C} , and hence $h(y)$ is an entire function.²² Fix $K > 0$. From assumption (i), $m_0(0) = 1$, and therefore $|m_0(y) - 1| \leq A|y|$ for all complex y with $|y| \leq K$. Then also $|m_0(2^{-j}y) - 1| \leq A2^{-j}K$. Since $\sum_{j=1}^{\infty} A2^{-j}K$ converges, the given infinite product $h(y) = \prod_{j=1}^{\infty} m_0(2^{-j}y)$ converges uniformly²³ on the compact subset of \mathbb{C} where $|y| \leq K$. The number K being arbitrary, $h(y)$ is an entire function of the complex variable y .

We are going to estimate the size of $h(y)$ as a function of the complex variable y . We begin by estimating the size of the entire function $m_0(y)$. Write m_0 out in the form of a trigonometric polynomial as $m_0(y) = \frac{1}{\sqrt{2}} \sum_{k=-M}^M a_k e^{-2\pi iky}$. Since $m_0(0) = 1$, we have

$$\sum_{k=-M}^M \frac{1}{\sqrt{2}} a_k e^{-2\pi iky} - 1 = \sum_{k=-M}^M \frac{1}{\sqrt{2}} a_k (e^{-2\pi ky} - 1)$$

and thus

$$|m_0(y) - 1| \leq \sum_{k=-M}^M \frac{1}{\sqrt{2}} |a_k| |e^{2\pi iky} - 1|.$$

Put $C = \sum_{k=-M}^M \frac{1}{\sqrt{2}} |a_k|$. Let us record that $\sum_{k=-M}^M \frac{1}{\sqrt{2}} a_k = 1$ implies

$$C = \sum_{k=-M}^M \frac{1}{\sqrt{2}} |a_k| \geq 1. \quad (*)$$

By comparing power series term by term, we have

$$|e^{2\pi iky} - 1| \leq e^{2\pi k|y|} - 1 \leq e^{2\pi M|y|} - 1,$$

Consequently

$$|m_0(y) - 1| \leq \left(\sum_{k=-M}^M \frac{1}{\sqrt{2}} |a_k| \right) (e^{2\pi M|y|} - 1) = C(e^{2\pi M|y|} - 1).$$

²²A sequence of analytic functions converges to an analytic function if the convergence is uniform on compact sets, according to Problem 55 in Appendix B of *Basic*.

²³This is the same argument as in the proof of Proposition 10.37 except that we are now allowing the variable to be complex.

Since $C \geq 1$ by (*), we have

$$C(e^{2\pi M|y|} - 1) = \sum_{n=1}^{\infty} \frac{C(2\pi M|y|)^n}{n!} \leq \sum_{n=1}^{\infty} \frac{(2\pi CM|y|)^n}{n!} = e^{2\pi CM|y|} - 1.$$

Thus

$$|m_0(y)| \leq 1 + |m_0(y) - 1| \leq e^{2\pi CM|y|}. \quad (**)$$

The product of the first J factors defining $h(y)$ is $\prod_{j=1}^J m_0(2^{-j}y)$, and its absolute value, according to (**), is

$$\prod_{j=1}^J |m_0(2^{-j}y)| \leq \prod_{j=1}^J e^{2\pi CM|2^{-j}y|} = \exp(2\pi CM|y| \sum_{j=1}^J 2^{-j}) \leq e^{2\pi CM|y|}.$$

Letting J tend to infinity, we obtain

$$|h(y)| \leq e^{2\pi CM|y|}. \quad (\dagger)$$

This estimate, which we shall return to a little later, is summarized by saying that the entire function $h(y)$ is of **exponential type**.

For the remainder of the proof, y can be regarded as a real variable. Let us write the inner product of f and g in $L^2(\mathbb{R})$ as (f, g) , and let us define a translation operator $T_k : L^2(\mathbb{R}) \rightarrow L^2(\mathbb{R})$ for $k \in \mathbb{Z}$ by $T_k f(x) = f(x - k)$. Each operator T_k is unitary. Put

$$\mathcal{C} = \{f \in L^2(\mathbb{R}) \mid \|f\|_2 = 1 \text{ and } (f, T_k f) = 0 \text{ for all } k \neq 0 \text{ in } \mathbb{Z}\}.$$

We shall prove that \mathcal{C} is a closed set. In fact, suppose that $\{f_n\}$ is a sequence in \mathcal{C} convergent to f in $L^2(\mathbb{R})$. Since the norm is continuous, $\|f\|_2 = 1$. For nonzero k in \mathbb{Z} , the equality

$$(f, T_k f) - (f_n, T_k f_n) = (f - f_n, T_k f) + (f_n, T_k f - T_k f_n)$$

together with the triangle inequality, the Schwarz inequality, and the fact that T_k is unitary give

$$\begin{aligned} |(f, T_k f) - (f_n, T_k f_n)| &\leq \|f - f_n\|_2 \|T_k f\|_2 + \|f_n\|_2 \|T_k(f - f_n)\|_2 \\ &= \|f\|_2 \|f - f_n\|_2 + \|f_n\|_2 \|f - f_n\|_2 \\ &= 2\|f - f_n\|_2. \end{aligned}$$

The right side has limit 0. Since $k \neq 0$ and f_n is in \mathcal{C} , the left side reduces to $|(f, T_k f)|$, and consequently $(f, T_k f) = 0$. Thus \mathcal{C} is a closed set.

Let φ_0 be the L^2 function with $\mathcal{F}\varphi_0 = I_{[-\frac{1}{2}, \frac{1}{2}]}$, i.e., the scaling function of the Shannon wavelet in Section 4. It was shown in the proof of Theorem 10.14 that the integer translates of φ_0 are orthonormal. Hence φ_0 is in \mathcal{C} . Since m_0 has to be bounded as a function of a real variable, we can define L^2 functions φ_n inductively for $n \geq 1$ by

$$(\mathcal{F}\varphi_n)(y) = (\mathcal{F}\varphi_0)(2^{-n}y) m_0(2^{-1}y) \cdots m_0(2^{-n}y). \quad (\dagger\dagger)$$

We shall prove inductively that each φ_n is in \mathcal{C} . The base case $n = 0$ of the induction having been settled, assume inductively that φ_{n-1} is in \mathcal{C} . Since $(\mathcal{F}\varphi_n)(y) = m_0(y/2)(\mathcal{F}\varphi_{n-1})(y/2)$, we have

$$\begin{aligned} \sum_{l \in \mathbb{Z}} |(\mathcal{F}\varphi_n)(y+l)|^2 &= \sum_{l \text{ even}} |m_0(\frac{1}{2}(y+l))|^2 |(\mathcal{F}\varphi_{n-1})(\frac{1}{2}(y+l))|^2 \\ &\quad + \sum_{l \text{ odd}} |m_0(\frac{1}{2}(y+l))|^2 |(\mathcal{F}\varphi_{n-1})(\frac{1}{2}(y+l))|^2 \\ &= |m_0(\frac{1}{2}y)|^2 \sum_{l \in \mathbb{Z}} |(\mathcal{F}\varphi_{n-1})(\frac{1}{2}y+l)|^2 \\ &\quad + |m_0(\frac{1}{2}y + \frac{1}{2})|^2 \sum_{l \in \mathbb{Z}} |(\mathcal{F}\varphi_{n-1})(\frac{1}{2}(y+1)+l)|^2 \\ &= |m_0(\frac{1}{2}y)|^2 + |m_0(\frac{1}{2}y + \frac{1}{2})|^2, \end{aligned}$$

the last equality holding by Lemma 10.11 and the inductive hypothesis. The last line of the above expression equals 1 by assumption (ii), and it follows from another application of Lemma 10.11 that φ_n is in \mathcal{C} . This completes the proof by induction that φ_n is in \mathcal{C} .

We know that the partial products $\prod_{j=1}^J m_0(2^{-j}y)$ converge uniformly on compact sets to what we have defined to be $h(y)$. Since $(\mathcal{F}\varphi_0)$ is continuous at 0 and has $(\mathcal{F}\varphi_0)(0) = 1$, a glance at $(\dagger\dagger)$ shows that

$$\lim_n (\mathcal{F}\varphi_n)(y) = h(y)$$

uniformly on compact sets. Applying Fatou's Lemma²⁴ to the absolute values squared, we obtain

$$\int_{\mathbb{R}} |h(y)|^2 dy \leq \liminf \int_{\mathbb{R}} |(\mathcal{F}\varphi_n)(y)|^2 dy.$$

The right side equals 1 since φ_n is in \mathcal{C} , and therefore the restriction of the entire function h to \mathbb{R} is in $L^2(\mathbb{R})$ with $\|h\|_2 \leq 1$. We let $\varphi = \mathcal{F}^{-1}h$, so that φ is in $L^2(\mathbb{R})$ with $\|\varphi\|_2 \leq 1$.

²⁴Theorem 5.29 of *Basic*.

We know that $\lim(\mathcal{F}\varphi_n) = \mathcal{F}\varphi$ uniformly on compact sets, and we are going to prove that the convergence takes place in $L^2(\mathbb{R})$. Once we have done so, the Plancherel Theorem will yield $\lim \varphi_n = \varphi$ in $L^2(\mathbb{R})$. Since \mathcal{C} is closed and each φ_n is in \mathcal{C} , we will then have proved that the integer translates of φ are orthonormal, and we will be on our way toward obtaining a multiresolution analysis.

To prove that $\mathcal{F}\varphi_n$ converges to $\mathcal{F}\varphi$ in $L^2(\mathbb{R})$, we are going to use dominated convergence, showing that for all n , $|(\mathcal{F}\varphi_n)(y)|$ is $\leq C_1|(\mathcal{F}\varphi)(y)|$ for some constant C_1 and all real y . By assumption (iii), $|m_0(y)|$ is nonzero for real y with $|y| \leq \frac{1}{4}$. The function $m_0(y)$ is continuous (being a trigonometric polynomial), and thus there is a positive number c such that $|m_0(y)| \geq c > 0$ for real y with $|y| \leq \frac{1}{4}$. By the uniform convergence of the partial products of $h(y)$ on compact sets, we can choose an integer J large enough so that $\prod_{j>J} |m_0(y2^{-j})| \geq \frac{1}{2}$ whenever $|y| \leq \frac{1}{2}$ and y is real. Then we have

$$|(\mathcal{F}\varphi)(y)| = \left(\prod_{j=1}^J |m_0(y2^{-j})| \right) \left(\prod_{j>J} |m_0(y2^{-j})| \right) \geq \frac{1}{2} \prod_{j=1}^J |m_0(y2^{-j})| \geq \frac{1}{2} c^J$$

for $|y| \leq \frac{1}{2}$. In other words, $\inf_{|y| \leq 1/2} |(\mathcal{F}\varphi)(y)| \geq c_1 > 0$ for some positive constant c_1 . The definition of $\mathcal{F}\varphi_n$ shows that $(\mathcal{F}\varphi_n)(y) = 0$ for $|y| > 2^{n-1}$ and hence that $|(\mathcal{F}\varphi_n)(y)| \leq c_1^{-1}|(\mathcal{F}\varphi)(y)|$ there. Meanwhile for $|y| \leq 2^{n-1}$, we have $(\mathcal{F}\varphi)(y) = (\mathcal{F}\varphi_n)(y)(\mathcal{F}\varphi)(2^{-n}y)$ and hence also

$$|(\mathcal{F}\varphi_n)(y)| = \left| \frac{(\mathcal{F}\varphi)(y)}{(\mathcal{F}\varphi)(2^{-n}y)} \right| \leq c_1^{-1}|(\mathcal{F}\varphi)(y)|.$$

Thus

$$|(\mathcal{F}\varphi_n)(y)| \leq c_1^{-1}|(\mathcal{F}\varphi)(y)| \quad \text{for all } y.$$

Consequently $|(\mathcal{F}\varphi_n)(y) - (\mathcal{F}\varphi)(y)|^2$ is dominated for all y by the multiple $(c_1^{-1} + 1)^2$ of $|(\mathcal{F}\varphi)(y)|^2$, which in turn has been shown to be integrable. By dominated convergence we therefore have

$$\lim \int_{\mathbb{R}} |(\mathcal{F}\varphi_n)(y) - (\mathcal{F}\varphi)(y)|^2 dy = \int_{\mathbb{R}} \lim |(\mathcal{F}\varphi_n)(y) - (\mathcal{F}\varphi)(y)|^2 dy = 0.$$

Thus $\mathcal{F}\varphi_n$ converges to $\mathcal{F}\varphi$ in $L^2(\mathbb{R})$, as asserted.

Let us recapitulate. We formed $h(y)$ as an infinite product of dilates of the trigonometric polynomial $m_0(y)$, exhibited it as a limit of functions $\mathcal{F}\varphi_n$ uniformly on compact sets, and deduced from Fatou's Lemma that h is in $L^2(\mathbb{R})$. We defined $\varphi = \mathcal{F}^{-1}h$ as a member of $L^2(\mathbb{R})$, and we saw that φ is in \mathcal{C} , i.e., its integer translates form an orthonormal set. The definitions made $h(y) = m_0(y/2)h(y/2)$, i.e.,

$$(\mathcal{F}\varphi)(y) = m_0(y/2)(\mathcal{F}\varphi)(y/2),$$

and thus φ satisfies a scaling equation. We now define $\varphi_{j,k}(x) = 2^{j/2}\varphi(2^jx - k)$ and let V_j be the closure of the linear span of $\{\varphi_{j,k}\}_{k=-\infty}^{\infty}$. The sequence $\{V_j\}$ is increasing, since φ satisfies a scaling equation. The claim is that $\{V_j\}$ and φ together form a multiresolution analysis in the sense of Section 3. Condition (iv) in the definition is satisfied, and condition (iii) is built into the definition. Proposition 10.15 shows that condition (ii) is automatic, and Proposition 10.17 says that condition (i) holds if $\mathcal{F}\varphi$ is a bounded function that is continuous and nonzero at $y = 0$. But $\mathcal{F}\varphi$ is just h , and we saw that h is the restriction to \mathbb{R} of an entire function with $h(0) = 1$. Thus indeed (i) holds. Consequently $\{V_j\}$ and φ together form a multiresolution analysis.

Next we are to show that φ has compact support. We saw that the L^2 function h extends to an entire function of exponential type. By the classical Paley–Wiener Theorem,²⁵ the L^2 function $\varphi = \mathcal{F}^{-1}h$ has compact support.

Finally we are to show that if $m_0(y)$ has real coefficients, then φ is real-valued. Since $m_0(y)$ has real coefficients, m_0 satisfies $m_0(y) = \overline{m_0(-y)}$. Referring to the formulas, we then see that $h(y) = \overline{h(-y)}$ and $\varphi(x) = \varphi(x)$. \square

Now we are in a position to collect all our results and produce the wavelets of compact support.

Theorem 10.39. Fix an integer $N \geq 1$, and define

$$P_N(w) = \sum_{k=0}^{N-1} \binom{N-1+k}{k} w^k.$$

Let $\mathcal{L}(y)$ be any of the trigonometric polynomials produced by Proposition 10.36 such that $|\mathcal{L}(y)|^2 = P_N(\sin^2 \pi y)$, and define

$$m_0(y) = \left(\frac{1 + e^{-2\pi iy}}{2} \right)^N \mathcal{L}(y).$$

Let $h(y)$ be the L^2 function

$$h(y) = \prod_{j=1}^{\infty} m_0(2^{-j}y),$$

and define $\varphi = \mathcal{F}^{-1}h$. Then φ has compact support and is the scaling function of a multiresolution analysis whose wavelet can be taken to have Fourier transform given by

$$(\mathcal{F}\psi)(y) = e^{-i\pi y} \overline{m_0(\frac{1}{2}y + \frac{1}{2})} h(y/2).$$

²⁵The classical Paley–Wiener Theorem says that a function h in $L^2(\mathbb{R})$ is of the form $h = \mathcal{F}\varphi$ for a function φ in $L^2(\mathbb{R})$ of compact support if and only if h (after adjustment on a set of measure 0) can be extended to all of \mathbb{C} as an entire function of exponential type. This theorem is not included in Chapter VIII of *Basic*, but instead the sufficiency appears as Theorem 10.41 at the end of the present section. The necessity is much easier but is not needed.

REMARKS.

(1) Proposition 10.36 produces a number of trigonometric polynomials $\mathcal{L}(y)$ with $|\mathcal{L}(y)|^2 = P_N(\sin^2 \pi y)$, corresponding to the subsets of roots α_j of a certain polynomial inside the unit disk. The **Daubechies wavelet** of order N arises by choosing the subset to consist of *all* the roots within the unit disk. All other choices of subsets of roots, however, lead to wavelets. The subsets that are closed under complex conjugation lead to φ and ψ real-valued.

(2) Theorem 10.39 contains no assertion of smoothness or even continuity for the Daubechies wavelets. This issue is postponed until the next section, in which we shall see that the Daubechies wavelets of order ≥ 2 are continuous and that they become progressively more differentiable as N increases. However, they are never infinitely differentiable. Graphs of the scaling functions and wavelets appear in Figures 10.17a and 10.17b, except that the wavelets have been translated by integers to make them better centered.²⁶ The cases of small N look as if they were drawn with a shaky hand, and this fact reflects the low order of differentiability in these cases.

(3) The Daubechies wavelet of order 1 is just the Haar wavelet. In fact, we have $P_1(w) = 1$. The polynomial $\mathcal{L}(y)$ is to have $|\mathcal{L}(y)|^2 = 1$ and thus can be taken to be 1. Then $m_0(y) = \frac{1}{2}(1 + e^{-2\pi iy})$, in agreement with the

formula in the example in Section 3. To compute $h(y) = \prod_{j=1}^{\infty} m_0(2^{-j}y)$, we write $m_0(y) = e^{-\pi iy} \cos \pi y$. The product of the exponentials $e^{-\pi i 2^{-j}y}$ comes out to be $e^{-\pi iy}$, and thus $h(y) = e^{-\pi iy} \prod_{j=1}^{\infty} \cos(2^{-j}\pi y)$. By making repeated use of

the identity $\sin 2\theta = 2 \sin \theta \cos \theta$, we obtain $2^J \sin(2^{-J}\pi y) \prod_{j=1}^J \cos(2^{-j}\pi y) = 2^{J-1} \sin(2^{-J+1}\pi y) \prod_{j=1}^{J-1} \cos(2^{-j}\pi y) = \dots = \sin \pi y$. Therefore

$$\prod_{j=1}^J \cos(2^{-j}\pi y) = \frac{\sin \pi y}{2^J \sin(2^{-J}\pi y)}.$$

Using $\lim_{\theta \rightarrow 0} \theta^{-1} \sin \theta = 1$ and passing to the limit, we obtain $\prod_{j=1}^{\infty} \cos(2^{-j}\pi y) = (\sin \pi y) / (\pi y)$. Hence

$$h(y) = e^{-i\pi y} \frac{\sin \pi y}{\pi y}.$$

The right side is the Fourier transform of the indicator function $I_{[0,1]}$, and thus $\varphi = I_{[0,1]}$, as asserted.

²⁶As the proof notes, the definition of $\mathcal{F}\psi$ involves an arbitrary periodic function ν of absolute value 1, and the figures use a power of $\nu(y) = e^{2\pi iy}$ to achieve this translation.

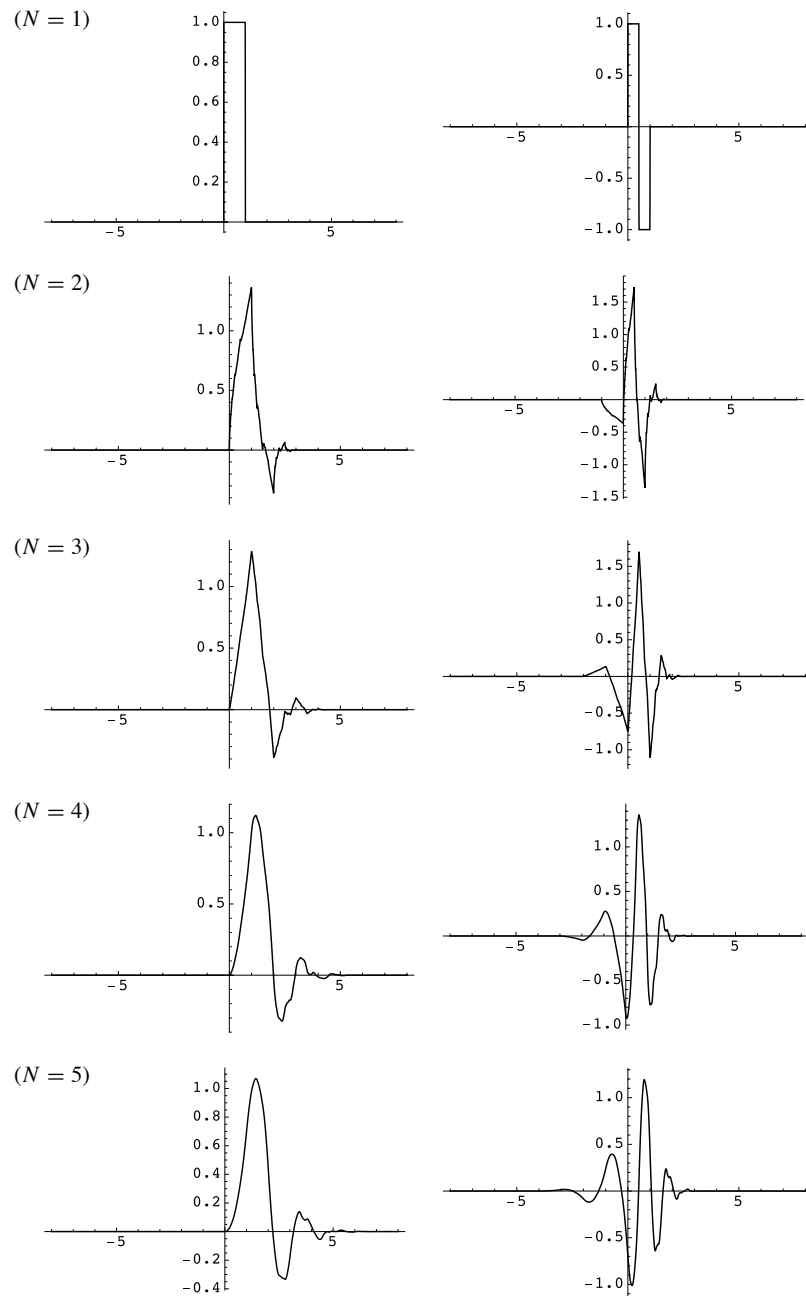

FIGURE 10.17a. Daubechies scaling function (left) and wavelet (right) of order N for $N = 1, 2, 3, 4, 5$.

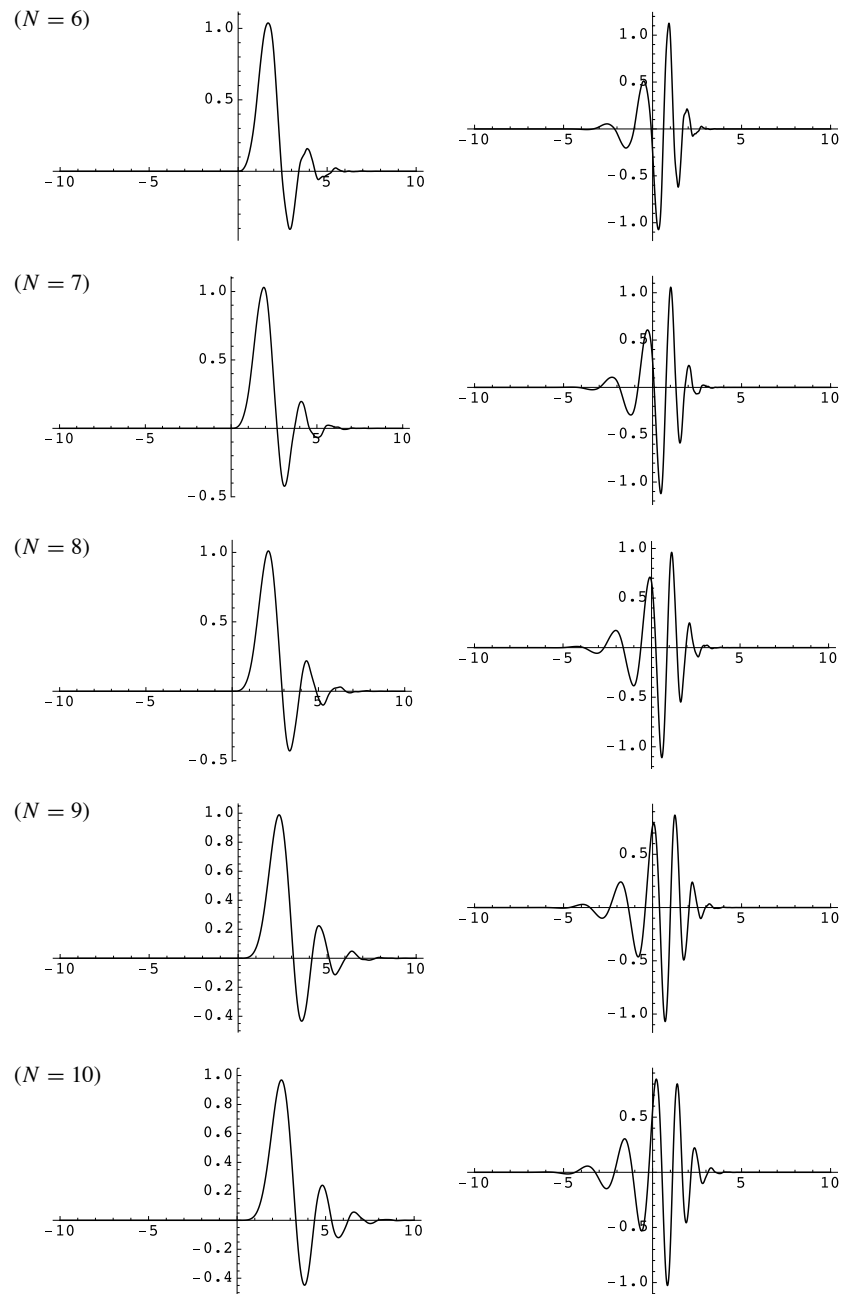

FIGURE 10.17b. Daubechies scaling function (left) and wavelet (right) of order N for $N = 6, 7, 8, 9, 10$.

(4) The Daubechies wavelet of order 2 is sufficiently complicated that no closed form is known for it. However, it is sufficiently simple that we can compute $m_0(y)$ exactly. For it, we have $P_2(w) = 1 + 2w$. Thus $P_2(\sin^2 \pi y) = 1 + 2 \sin^2 \pi y = |\mathcal{L}(y)|^2$. Proposition 10.36 tells us how to find the possibilities for $\mathcal{L}(y)$. In the proposition the function t has $t(y) = 1 + 2 \sin^2 \pi y = 2 - \cos 2\pi y = -\frac{1}{2}e^{-2\pi iy} + 2 - \frac{1}{2}e^{2\pi iy}$. In the notation of the proof of that proposition, we have $M = 1$, $Q(y) = -\frac{1}{2} + 2y - \frac{1}{2}y^2$, and $z^2 Q(z^{-1}) = \overline{Q(\bar{z})}$. The zeros of $Q(z)$ occur at $2 \pm \sqrt{3}$, and we are to use the one inside the unit disk, namely $2 - \sqrt{3}$, in defining $\mathcal{L}(y)$. The proof of the proposition says to use $r(y) = e^{-2\pi iy} - (2 - \sqrt{3})$ as a first approximation to $\mathcal{L}(y)$. Then $|r(y)|^2 = (8 - 4\sqrt{3}) - 2(2 - \sqrt{3}) \cos 2\pi y = c'(2 - \cos 2\pi y) = c't(y)$, where $c' = 4 - 2\sqrt{3}$. Since $(c')^{-1/2} = \frac{1}{2}(1 + \sqrt{3})$, the proof of the proposition says that $\mathcal{L}(y) = \frac{1}{2}(1 + \sqrt{3})r(y)$ has $|\mathcal{L}(y)|^2 = t(y)$. In other words, $\mathcal{L}(y) = \frac{1}{2}(1 + \sqrt{3})(e^{-2\pi iy} - (2 - \sqrt{3}))$. Then $m_0(y)$ is given by $= \frac{1}{4}(1 + e^{-2\pi iy})^2 \mathcal{L}(y)$, i.e.,

$$m_0(y) = \frac{1}{2}(1 + \sqrt{3})(e^{-2\pi iy} - (2 - \sqrt{3}))\frac{1}{4}(1 + e^{-2\pi iy})^2.$$

Observe that the expansion of $m_0(y)$ in terms of exponentials has exactly four nonzero coefficients—those for 1, $e^{-2\pi iy}$, $e^{-4\pi iy}$, and $e^{-6\pi iy}$.

(5) The Daubechies wavelet of order N , when expanded in terms of exponentials, has exactly $2N$ nonzero coefficients—those for 1, $e^{-2\pi ix}$, \dots , $e^{-2\pi i(2N-1)x}$. Decimal approximations of these coefficients for $2 \leq N \leq 10$ appear in a table²⁷ on page 195 of the award-winning book by Daubechies, *Ten Lectures on Wavelets*.

PROOF OF THEOREM 10.39. Proposition 10.34 shows that when defined as in the statement of the theorem, $m_0(y)$ satisfies $|m_0(y)|^2 + |m_0(y + \frac{1}{2})|^2 = 1$, as well as $m_0(0) = 1$. Also

$$\begin{aligned} |m_0(y)|^2 &= 2^{-2N} |1 + e^{-2\pi iy}|^{2N} P_N(\sin^2 \pi y) \\ &= (\cos^2 \pi y)^N \sum_{k=0}^{N-1} \binom{2N-1}{k} (\sin^2 \pi y)^k (\cos^2 \pi y)^{N-k} \\ &\geq (\cos^2 \pi y)^{2N}, \end{aligned}$$

and this is > 0 for $|y| \leq \frac{1}{4}$. Therefore the hypotheses of Proposition 10.38 are satisfied, and we can conclude that

$$h(y) = \prod_{j=1}^{\infty} m_0(2^{-j} y)$$

²⁷The coefficients in the table differ from those in the present book by a factor of $\sqrt{2}$. One can verify this fact for $N = 2$ by using the coefficients obtained for $N = 2$ in the previous remark.

defines an entire function for $y \in \mathbb{C}$ with $h(0) = 1$ whose restriction to \mathbb{R} is in $L^2(\mathbb{R})$. Moreover, the proposition says that $\varphi = \mathcal{F}^{-1}h$ is compactly supported and is the scaling function for a multiresolution analysis. According to Theorem 10.10, the corresponding wavelet is any function of the form

$$(\mathcal{F}f)(y) = e^{\pi iy} \overline{v(y)m_0(\frac{1}{2}y + \frac{1}{2})}(\mathcal{F}\varphi)(y/2)$$

with v periodic of period 1 and with $|v(y)| = 1$ everywhere. If we take into account that $\mathcal{F}\varphi = h$ and if we put $v(y) = e^{-2\pi iy}$, then the resulting formula is

$$(\mathcal{F}\psi)(y) = e^{-i\pi y} \overline{m_0(\frac{1}{2}y + \frac{1}{2})}h(y/2). \quad \square$$

Before turning to smoothness questions, we insert as Theorem 10.41 the hard direction of the **Paley–Wiener Theorem**. This result was used at a critical point in the proof of Proposition 10.38. In the course of proving Theorem 10.41, we shall make use of the **Phragmén–Lindelöf Theorem**, which is a variant of the Three Lines Theorem (*Basic*, Lemma 9.19B, p. 471).

Lemma 10.40 (Phragmén–Lindelöf Theorem). Let f be a function that is analytic in an open neighborhood of the closure \overline{D} of an open sector D of \mathbb{C} with angular opening $< \pi$. Suppose that $|f(z)| \leq C$ on the boundary of D and that f satisfies a growth estimate $|f(z)| \leq C'e^{M|z|}$ throughout \overline{D} . Then $|f(z)| \leq C$ throughout \overline{D} .

PROOF. Without loss of generality, we may assume that D is positioned symmetrically about the positive x axis with vertex at the origin and with angle ψ on each side of the axis. Since $\psi < \frac{\pi}{2}$ by assumption, we can choose and fix $\alpha > 1$ with $\alpha\psi < \frac{\pi}{2}$. For each positive number ε , define $g_\varepsilon(z) = f(z)e^{-\varepsilon z^\alpha}$, where z^α refers to the principal value. For $z = re^{i\theta}$ in \overline{D} with $|\theta| \leq \psi$, we have

$$|g_\varepsilon(z)| \leq C'e^{M|z|}|e^{-\varepsilon(r e^{i\theta})^\alpha}| = C'e^{Mr}e^{-\varepsilon r^\alpha \cos(\alpha\theta)} \leq C'e^{Mr}e^{-\varepsilon r^\alpha \cos(\alpha\psi)}.$$

Since $\alpha > 1$, this tends to 0 as r tends to infinity, and we can regard g_ε as continuous on the compact subset $\overline{D} \cup \{\infty\}$ of the extended plane. Then $|g_\varepsilon(z)|$ has an absolute maximum at some point z_ε of $\overline{D} \cup \{\infty\}$. The point z_ε cannot be ∞ , and the maximum principle for analytic functions then forces z_ε to be on the boundary of \overline{D} . Hence $|g_\varepsilon(z_\varepsilon)| \leq C$. Consequently $|g_\varepsilon(z)| \leq C$ and $|f(z)| \leq C|e^{-\varepsilon z^\alpha}|$ everywhere on \overline{D} . Passing to the limit as ε decreases to 0, we see that $|f(z)| \leq C$ everywhere on \overline{D} . \square

Theorem 10.41 (Paley–Wiener Theorem). If h is an L^2 function on \mathbb{R} that extends to an entire function on \mathbb{C} of exponential type, then the Fourier transform of h has compact support.

REMARK. In our application within the proof of Proposition 10.38, we needed $\varphi = \mathcal{F}^{-1}h$ to be of compact support, and the assertion here is about $\mathcal{F}h$. However, the question of compact support comes to the same thing for $\mathcal{F}h$ and $\mathcal{F}^{-1}h$, since $(\mathcal{F}^{-1}h)(\xi) = (\mathcal{F}h)(-\xi)$.

PROOF. We regard h as an entire function on \mathbb{C} with $|h(z)| \leq Ae^{2\pi M|z|}$ for all z . Allusions to the Fourier transform are to the restriction of h to \mathbb{R} . For most of the proof, we shall assume that h is bounded on \mathbb{R} , say with $|h(x)| \leq B$. Toward the end of the proof, we shall show how to drop this assumption.

We shall prove that $(\mathcal{F}h)(\xi) = 0$ a.e. for $|\xi| > M$. We handle $\xi > M$ and $\xi < -M$ separately. First suppose that $\xi > M$. For $\varepsilon > 0$, we introduce $h_\varepsilon(z) = h(z)/(1 + i\varepsilon z)^2$. This is analytic in a neighborhood of the lower half plane $\text{Im } z \leq 0$, and its restriction to \mathbb{R} is in $L^1(\mathbb{R})$, being the product of two functions in $L^2(\mathbb{R})$. We shall show that its Fourier transform $\widehat{h}_\varepsilon(\xi)$ vanishes for $\xi > M$. We are going to move the contour of integration in the integral $\widehat{h}_\varepsilon(\xi) = \int_{-\infty}^{\infty} h_\varepsilon(x)e^{-2\pi i \xi x} dx$.

Let $b > 0$ be arbitrary. Form the rectangle in \mathbb{C} whose top side extends from $-R$ to R on the real axis and whose bottom side extends from $-R - ib$ to $-R + ib$. Orient the rectangle clockwise. The total integral over the rectangle of $h_\varepsilon(z)e^{-2\pi i \xi z}$ is 0 by the Cauchy Integral Theorem, and we are going to show that in the limit $R \rightarrow \infty$ and then $b \rightarrow \infty$, the other three sides each contribute 0. Then the conclusion will be that the contribution from the top side is 0, i.e., that $\widehat{h}_\varepsilon(\xi) = 0$.

To estimate the contributions from the vertical sides and bottom of the rectangle, we shall apply Lemma 10.40 (the Phragmén–Lindelöf Theorem) twice to the analytic function $h(z)e^{-2\pi i Mz}$ in the lower half plane. Consider the quadrant with $\text{Re } z \geq 0$ and $\text{Im } z \leq 0$. On the positive real axis we have

$$|h(x)e^{-2\pi i Mx}| = |h(x)| \leq B,$$

while on the negative imaginary axis $\{-iy \text{ with } y \geq 0\}$ we have

$$|h(-iy)e^{-2\pi i M(-iy)}| \leq Ae^{2\pi M|-iy|}e^{-2\pi My} = A.$$

On the whole quadrant where $\text{Re } z \geq 0$ and $\text{Im } z \leq 0$, we have

$$|h(z)|e^{-2\pi i Mz} = |h(z)|e^{2\pi M|\text{Im } z|} \leq Ae^{2\pi M|z|}e^{2\pi M|\text{Im } z|} \leq Ae^{4\pi M|z|}.$$

Thus the lemma applies with $C = \max\{A, B\}$ and gives the bound

$$|h(z)e^{-2\pi i Mz}| \leq C \tag{*}$$

everywhere on the quadrant. We can argue similarly with the quadrant for which $\operatorname{Re} z \leq 0$ and $\operatorname{Im} z \leq 0$. The estimates are the same, and Lemma 10.40 yields the bound (*) whenever $\operatorname{Re} z \leq 0$ and $\operatorname{Im} z \leq 0$. Consequently

$$|h(x + iy)| \leq C |e^{2\pi i M(x+iy)}| = C e^{2\pi M|y|} \quad (**)$$

whenever $y \leq 0$.

To estimate the contributions from the vertical sides, where $|x| = R$, we apply (**) and make use of the bound

$$|h_\varepsilon(z)| \leq |h(z)|(1 + \varepsilon^2|z|^2)^{-1} \leq C e^{2\pi M|y|} (1 + \varepsilon^2 R^2)^{-1} \leq C \varepsilon^{-2} R^{-2} e^{2\pi M b}.$$

The integral over the right vertical side is

$$\leq \int_0^{-b} |h_\varepsilon(R + it)| |e^{-2\pi i \xi(R+it)}| dt \leq C \varepsilon^{-2} R^{-2} e^{2\pi M b} \int_0^{-b} e^{2\pi \xi t} dt.$$

Since we are holding b fixed as we let R tend to infinity, this term tends to 0. Similarly the integral over the left vertical side tends to 0.

After the passage to the limit in R and the application of the Cauchy Integral Theorem, we see that $\widehat{h}_\varepsilon(\xi)$ equals the integral over the bottom side of the rectangle, i.e., that

$$\widehat{h}_\varepsilon(\xi) = \int_{-\infty}^{\infty} h_\varepsilon(x - ib) e^{-2\pi i \xi(x-ib)} dx.$$

On the right side we use the bound (**) and the estimate

$$|h_\varepsilon(z)| = |h(z)|(1 + \varepsilon^2|z|^2)^{-1} \leq |h(z)|(1 + \varepsilon^2 x^2)^{-1}$$

to see that

$$|\widehat{h}_\varepsilon(\xi)| \leq \int_{-\infty}^{\infty} (1 + \varepsilon^2 x^2)^{-1} C e^{2\pi M b} e^{-2\pi \xi b} dx = c e^{-2\pi b(\xi - M)}.$$

As b tends to infinity, the right side tends to 0 because $\xi > M$. Thus $\widehat{h}_\varepsilon(\xi) = 0$.

Still with $\xi > M$, we shall let ε tend to 0. Let g be any function in $C_{\text{com}}^\infty(\mathbb{R})$ with support in the interval $(M, +\infty)$. Then the multiplication formula gives $0 = \int_{\mathbb{R}} \widehat{h}_\varepsilon g dx = \int_{\mathbb{R}} h_\varepsilon \widehat{g} dx$, i.e.,

$$0 = \int_{\mathbb{R}} \frac{h(x) \widehat{g}(x)}{(1 + i\varepsilon x)^2} dx$$

for every $\varepsilon > 0$. Here h and \widehat{g} are in $L^2(\mathbb{R})$ and also $|(1 + i\varepsilon x)^{-2}| \leq 1$. Thus we have dominated convergence as ε tends to 0, and we obtain

$$0 = \int_{\mathbb{R}} h(x) \widehat{g}(x) dx = \int_{\mathbb{R}} (\mathcal{F}h)(\xi) g(\xi) d\xi.$$

Since g is any smooth function supported in $(M, +\infty)$, we see that $(\mathcal{F}h)(\xi) = 0$ a.e. for $\xi > M$.

In similar fashion we argue for $\xi < -M$ by using approximating functions $h_\varepsilon(z) = h(z)/(1 - i\varepsilon z)^2$ and working in the upper half plane. Lemma 10.40 is to be applied to the function $h(z)e^{2\pi i M z}$ in the two quadrants of the upper half plane. The new version of estimate (***) is that $|h(x + iy)| \leq C e^{2\pi M|y|}$ whenever $y \geq 0$. The result is that $(\mathcal{F}h)(\xi) = 0$ a.e. for $\xi < -M$.

This completes the proof under the assumption that h is bounded. To see that we can drop this assumption, let $u \geq 0$ be in $C_{\text{com}}(\mathbb{R})$, and form the convolution $h_u(z) = \int_{\mathbb{R}} h(z - t)u(t) dt$. The function h_u is entire, and it has

$$\begin{aligned} |h_u(z)| &= \left| \int_{\mathbb{R}} h(z - t)u(t) dt \right| \leq \int_{\mathbb{R}} |h(z - t)|u(t) dt \\ &\leq A \int_{\mathbb{R}} e^{2\pi M|z-t|} u(t) dt \leq A e^{2\pi M|z|} \int_{\mathbb{R}} e^{2\pi M|t|} u(t) dt = A' e^{2\pi M|z|}. \end{aligned}$$

The argument in the special case applies to h_u and shows that $\mathcal{F}h_u$ vanishes a.e. for $|\xi| > M$. If we replace $u(x)$ by $u_\varepsilon(x) = \varepsilon^{-1}u(\varepsilon^{-1}x)$ and let ε decrease to 0, then $\lim h_{u_\varepsilon} = h$ in $L^2(\mathbb{R})$, and so $\lim \mathcal{F}h_{u_\varepsilon} = \mathcal{F}h$ in $L^2(\mathbb{R})$. Since $\mathcal{F}h_{u_\varepsilon}$ vanishes a.e. for $|\xi| > M$, so does $\mathcal{F}h$. \square

10. Smoothness Questions

The Daubechies wavelet of order N that was constructed in Theorem 10.39 has compact support, but we have not yet proved that it and its scaling function are continuous if $N \geq 2$. (For $N = 1$, the resulting wavelet is the Haar wavelet, which is certainly not continuous.)

We shall get at this continuity in this section. As a general principle, the more rapidly the Fourier transform of a function f decays at infinity, the smoother that f is. An explanation in simple terms is that under certain technical assumptions given in Proposition 8.1 of *Basic*, the Fourier transform of $\frac{d}{dx}f(x)$ is $2\pi iyf(y)$. Thus the starting point for our study is an investigation of the rapidity of decay at infinity of $\mathcal{F}\varphi$, φ being the scaling function of the Daubechies wavelet of order N .

Lemma 10.42. The binomial coefficient $\binom{2n}{n}$ satisfies $\binom{2n}{n} \leq \frac{4^n}{\sqrt{\pi n}}$ for all $n \geq 1$.

REMARK. In fact, the ratio of the two sides of the inequality tends to 1, as is easily seen by examining the proof of the lemma closely.

PROOF. Because of the orthogonality of the exponentials on $[-\pi, \pi]$, the 0th Fourier coefficient of $\cos^{2n} x$ is

$$\begin{aligned} \frac{1}{2\pi} \int_{-\pi}^{\pi} \cos^{2n} x \, dx &= \frac{2^{-2n}}{2\pi} \int_{-\pi}^{\pi} (e^{ix} + e^{-ix})^{2n} \, dx \\ &= \frac{2^{-2n}}{2\pi} \int_{-\pi}^{\pi} \sum_{k=0}^{2n} \binom{2n}{k} e^{ikx} e^{i(2n-k)x} \, dx = 2^{-2n} \binom{2n}{n}. \end{aligned}$$

Since $\cos x$ is even,

$$\binom{2n}{n} = \frac{4^n}{\pi} \int_{-\pi/2}^{\pi/2} \cos^{2n} x \, dx. \quad (*)$$

Consider the function $f(x) = \log \cos x + \frac{1}{2}x^2$ on $[-\pi/2, \pi/2]$. It has $f(0) = f'(0) = 0$ and $f''(x) = -\sec^2 x + 1$. Therefore it has an absolute maximum at $x = 0$, and we obtain the inequality

$$\log \cos x \leq -\frac{1}{2}x^2 \quad \text{for } -\frac{\pi}{2} \leq x \leq \frac{\pi}{2}.$$

Exponentiating and raising both sides to the $(2n)$ th power gives

$$\cos^{2n} x \leq e^{-nx^2} \quad \text{for } -\frac{\pi}{2} \leq x \leq \frac{\pi}{2}.$$

Thus (*) is

$$\leq \frac{4^n}{\pi} \int_{-\pi/2}^{\pi/2} e^{-nx^2} \, dx \leq \frac{4^n}{\pi} \int_{-\infty}^{\infty} e^{-nx^2} \, dx = \frac{4^n}{\pi} \sqrt{\frac{\pi}{n}} \int_{-\infty}^{\infty} e^{-\pi y^2} \, dy = \frac{4^n}{\sqrt{\pi n}}. \quad \square$$

Proposition 10.43. For every $N \geq 1$ and every integer $j \geq 1$, the scaling function φ of the Daubechies wavelet of order N satisfies an estimate

$$|(\mathcal{F}\varphi)(y)|^2 \leq \left(\frac{2^{N-1}}{\sqrt{\pi N}} \right) (\sqrt{4\pi N})^{-j} \quad \text{for } 2^{j-1} \leq |y| \leq 2^j.$$

Consequently

$$\int_{2^{j-1} \leq |y| \leq 2^j} |(\mathcal{F}\varphi)(y)| \, dy \leq \left(\frac{2^{N-1}}{\sqrt{\pi N}} \right)^{1/2} (\pi N/4)^{-j/4}.$$

PROOF. For the moment we allow y to be an arbitrary real number. Theorem 10.39 says that

$$(\mathcal{F}\varphi)(y) = \prod_{j=1}^{\infty} m_0(2^{-j}y),$$

where $m_0(y) = e^{-\pi i N y} (\cos \pi y)^N \mathcal{L}(y)$ and $|\mathcal{L}(y)|^2 = P_N(\sin^2 \pi y)$. Moreover, Lemma 10.35c gives $0 \leq P_N(\sin^2 \pi y) \leq \binom{2N-1}{N}$. Thus

$$\begin{aligned}
|(\mathcal{F}\varphi)(y)|^2 &= \prod_{k=1}^{\infty} |m_0(2^{-k}y)|^2 \\
&\leq \prod_{k=1}^{j+1} |m_0(2^{-k}y)|^2 && \text{since } |m_0(y)| \leq 1 \\
&= \prod_{k=1}^{j+1} (\cos 2^{-k}\pi y)^{2N} P_N(\sin^2 2^{-k}\pi y) \\
&\leq \prod_{k=1}^{j+1} \left((\cos 2^{-k}\pi y)^{2N} \binom{2N-1}{N} \right) && \text{by Lemma 10.35c} \\
&= \left(\prod_{k=1}^{j+1} \cos 2^{-k}\pi y \right)^{2N} \binom{2N-1}{N}^{j+1} \\
&= \left(\prod_{k=1}^{j+1} \cos 2^{-k}\pi y \right)^{2N} \left(\frac{N}{2N} \binom{2N}{N} \right)^{j+1} \\
&\leq \left(\prod_{k=1}^{j+1} \cos 2^{-k}\pi y \right)^{2N} \left(\frac{1}{2} \frac{4^N}{\sqrt{\pi N}} \right)^{j+1} && \text{by Lemma 10.42. } (*)
\end{aligned}$$

To handle the product of powers of cosine, we use the same trick as in Remark 3 with Theorem 10.39, namely repeated application of the identity $\sin 2\theta = 2 \sin \theta \cos \theta$:

$$\begin{aligned}
2^{j+1} \sin(2^{-(j+1)}\pi y) \prod_{k=1}^{j+1} \cos(2^{-k}\pi y) &= 2^j \sin(2^{-j}\pi y) \prod_{k=1}^j \cos(2^{-k}\pi y) \\
&= \dots = \sin \pi y.
\end{aligned}$$

Thus

$$\prod_{k=1}^{j+1} \cos 2^{-k}\pi y = \frac{\sin \pi y}{2^{j+1} \sin 2^{-(j+1)}\pi y},$$

and (*) is

$$\leq \left(\frac{\sin \pi y}{2^{j+1} \sin 2^{-(j+1)}\pi y} \right)^{2N} \left(\frac{1}{2} \frac{4^N}{\sqrt{\pi N}} \right)^{j+1}. \quad (**)$$

We now bring in the constraint $2^{j-1} \leq |y| \leq 2^j$ in order to give an upper bound for the first factor. In the numerator we use $|\sin \pi y| \leq 1$. For the denominator, the absolute value of the argument of the sine lies between $\pi/4$ and $\pi/2$. Thus $|\sin 2^{-(j+1)}\pi y| \geq \sin \pi/4 = 2^{-1/2}$, and (**) is

$$\leq 4^{-jN} 2^{-(1/2)(2N)} \left(\frac{1}{2} \frac{4^N}{\sqrt{\pi N}} \right)^{j+1} = 2^{-N} \left(\frac{1}{2} \frac{4^N}{\sqrt{\pi N}} \right) (2\sqrt{\pi N})^{-j} = \left(\frac{2^{N-1}}{\sqrt{\pi N}} \right) (2\sqrt{\pi N})^{-j}.$$

This proves the upper bound for $|(\mathcal{F}\varphi)(y)|^2$.

An upper bound for the integral is the product of the square root of this bound by the measure 2^j of the set of integration. The result follows. \square

As soon as $N\pi > 4$, namely as soon as $N \geq 2$, the sum over $j \geq 1$ of the integrals in Proposition 10.43 is finite, and it follows that $\mathcal{F}\varphi$ is integrable. Consequently the function $\varphi = \mathcal{F}^{-1}\mathcal{F}\varphi$, after adjustment on a set of measure 0, is a bounded continuous function vanishing at infinity. We already knew that it had compact support (and hence vanishes at infinity), and the new fact is that it is continuous. Since in the case of compact support the wavelet is a finite linear combination of translates of dilates of the scaling function, the wavelet itself is continuous. Let us state that result as a corollary.

Corollary 10.44. For every $N \geq 2$, the scaling function φ of the Daubechies wavelet of order N is continuous, and so is the wavelet ψ itself.

The pointwise estimate in Proposition 10.43 gives more, however. One way of proceeding is to observe as a further corollary of Proposition 10.41 that $|(\mathcal{F}\varphi)(y)|^2(1+|y|^2)^s$ is integrable for specific values of s . In the terminology of Problems 8–12 for Chapter III, f is in certain spaces $H^s(\mathbb{R})$ of “Bessel potentials.” We elaborate on this approach in Problems 18–19 at the end of the present chapter. But for now we shall proceed somewhat differently, so as to avoid invoking results from Chapter III.

If $0 < \alpha < 1$, we say that a continuous function f on \mathbb{R} satisfies a **Hölder condition** with exponent α if there is a constant C such that $|f(x+h) - f(x)| \leq C|h|^\alpha$ whenever x and h are in \mathbb{R} with $|h| \leq 1$.

Proposition 10.45. Fix $\alpha > 0$. Suppose that

- (i) f is a compactly supported member of $L^2(\mathbb{R})$,
- (ii) $\mathcal{F}f$ is integrable and f has been adjusted on a set of measure 0 so as to be continuous, and
- (iii) there is a constant C with

$$\int_{2^{j-1} \leq |y| \leq 2^j} |(\mathcal{F}f)(y)| dy \leq C2^{-\alpha j} \quad \text{for every integer } j \geq 0.$$

If $0 < \alpha < 1$, then f satisfies a Hölder condition with exponent α . If the inequality $n < \alpha < n + 1$ holds for some positive integer n , then f is of class C^n , and its n^{th} derivative $f^{(n)}$ is in $L^2(\mathbb{R})$ and satisfies a Hölder condition with exponent $\alpha - n$.

REMARK. In our case we define α so that $2^{-\alpha} = (\pi N/4)^{-1/4}$, and Proposition 10.43 establishes the estimate in the hypothesis of Proposition 10.45. In other words, α is any number $\leq \frac{1}{4} \log_2(\pi N/4)$.

PROOF. First suppose that $0 < \alpha < 1$. Under the hypotheses on f , we can write f pointwise as the inverse Fourier transform of $\mathcal{F}f$, and then

$$f(x+h) - f(x) = \int_{\mathbb{R}} e^{2\pi ixy} (e^{2\pi ihy} - 1) (\mathcal{F}f)(y) dy,$$

the integrand being integrable. We are to estimate

$$|f(x+h) - f(x)| \leq \int_{\mathbb{R}} |e^{2\pi ihy} - 1| |(\mathcal{F}f)(y)| dy \quad (*)$$

With $|h| \leq 1$, we define the index $j = j(h) \geq 0$ so that $2^{-(j+1)} \leq |h| < 2^{-j}$, and then we break the region of integration in $(*)$ into three sets S_1 , S_2 , and S_3 as follows: $S_1 = S_1(h)$ where $0 \leq |y| < \frac{1}{2}$, $S_2 = S_2(h)$ where $\frac{1}{2} \leq |y| < 2^{j(h)}$, and $S_3 = S_3(h)$ where $2^{j(h)} \leq |y|$.

For the integral over S_1 , we use the inequality $|e^{i\theta} - 1| \leq |\theta|$, which is valid for all real θ , to write

$$\int_{S_1} |e^{2\pi ihy} - 1| |(\mathcal{F}f)(y)| dy \leq 2\pi|h| \int_{S_1} |y| |(\mathcal{F}f)(y)| dy \leq \pi|h|^\alpha \|\mathcal{F}f\|_1.$$

For the integral over S_2 , we have similarly

$$\begin{aligned} \int_{S_2} |e^{2\pi ihy} - 1| |(\mathcal{F}f)(y)| dy &\leq 2\pi|h| \int_{S_2} |y| |(\mathcal{F}f)(y)| dy \\ &= 2\pi|h| \sum_{k=0}^{j(h)} \int_{2^{k-1} \leq |y| < 2^k} |y| |(\mathcal{F}f)(y)| dy \\ &\leq 2\pi|h| \sum_{k=0}^{j(h)} 2^k \int_{2^{k-1} \leq |y| < 2^k} |(\mathcal{F}f)(y)| dy \\ &\leq 2\pi|h| \sum_{k=0}^{j(h)} 2^k C 2^{-\alpha k} \\ &= 2\pi C|h| \sum_{k=0}^{j(h)} 2^{(1-\alpha)k} \\ &\leq 2\pi C|h| (2^{1-\alpha} - 1)^{-1} 2^{(1-\alpha)(j(h)+1)}. \end{aligned}$$

Since $2^{-(j(h)+1)} \leq |h| \leq 2^{-j(h)}$, we have $|h| = |h|^\alpha |h|^{1-\alpha} \leq |h|^\alpha 2^{-(1-\alpha)j(h)}$, and thus

$$\int_{S_2} |e^{2\pi ihy} - 1| |(\mathcal{F}f)(y)| dy \leq 2\pi C 2^{1-\alpha} (2^{1-\alpha} - 1)^{-1} |h|^\alpha.$$

For the integral over S_3 , we have

$$\begin{aligned}
 \int_{S_3} |e^{2\pi ihy} - 1| |(\mathcal{F}f)(y)| dy &\leq 2 \int_{S_3} |(\mathcal{F}f)(y)| dy \\
 &= 2 \sum_{k=j(h)+1}^{\infty} \int_{2^{k-1} \leq |y| \leq 2^k} |(\mathcal{F}f)(y)| dy \\
 &\leq 2 \sum_{k=j(h)+1}^{\infty} C 2^{-\alpha k} \\
 &= 2C(1 - 2^{-\alpha})^{-1} 2^{-\alpha(j(h)+1)} \\
 &\leq 2C(1 - 2^{-\alpha})^{-1} |h|^\alpha.
 \end{aligned}$$

Combining the estimates for S_1 , S_2 , and S_3 , we obtain

$$|f(x+h) - f(x)| \leq C'|h|^\alpha,$$

as required. This completes the proof for $0 < \alpha < 1$.

Now suppose that $\alpha > 1$. Proceeding inductively, we shall show that f is of class C^1 and that f' satisfies the hypotheses of the proposition for the index $\alpha - 1$. Then the result will follow by induction.

First of all, we have

$$\int_{2^{j-1} \leq |y| \leq 2^j} |y| |(\mathcal{F}f)(y)| dy \leq \int_{2^{j-1} \leq |y| \leq 2^j} 2^j |(\mathcal{F}f)(y)| dy \leq C 2^{-(\alpha-1)j},$$

and it follows that $|y| |(\mathcal{F}f)(y)|$ is integrable.

To prove²⁸ that f is of class C^1 , we make use of the inequality

$$|h^{-1}(e^{2\pi iyh} - 1)| \leq 2\pi|y| \tag{**}$$

valid for $|h| \leq 1$; this inequality follows from the inequality $|e^{i\theta} - 1| \leq |\theta|$ that was used for estimating S_1 . We have

$$\frac{f(x+h) - f(x)}{h} = \int_{\mathbb{R}} (\mathcal{F}f)(y) e^{2\pi iyx} \left[\frac{e^{2\pi iyh} - 1}{h} \right] dy.$$

The expression in brackets is $\leq 2\pi|y|$ in absolute value by (**), and we have seen that $y(\mathcal{F}f)(y)$ is integrable. Therefore we have dominated convergence, and we conclude that

$$f'(x) = \int_{\mathbb{R}} (\mathcal{F}f)(y) (2\pi iy) e^{2\pi iyx} dy,$$

²⁸This argument is a version of the proof of Proposition 8.1g of *Basic*, but it is easier to write out the details of the argument than to show that the C^1 property follows from Proposition 8.1g.

the derivative existing. Except for an extra minus sign in the exponential, this formula exhibits f' as the Fourier transform of the integrable function $2\pi iy(\mathcal{F}f)(y)$, and f' is therefore continuous. Since f has compact support, so does f' . The Fourier inversion formula is applicable, and we obtain

$$(\mathcal{F}f')(y) = (2\pi iy)(\mathcal{F}f)(y).$$

We conclude that f' satisfies the hypotheses of the proposition for the index $\alpha - 1$, and the proof is complete. \square

Corollary 10.46. Let n be a positive integer. If N is large enough so that $\frac{1}{4} \log_2(\pi N/4) > n$, then the scaling function of the Daubechies wavelet of order N is of class C^n , and the same thing is true of the wavelet itself.

PROOF. This follows immediately by combining Proposition 10.43 and Proposition 10.45. \square

Qualitatively Corollary 10.46 says that if n is given, then the scaling function is of class C^n if N is sufficiently large. The growth of n as a function of N is logarithmic. For example, the corollary asks that N be at least 21 before it guarantees that the scaling function is of class C^1 . Quantitatively this result does not appear to be very sharp if one takes into account the appearance of the curves in Figures 10.17a and 10.17b. In fact, Daubechies with much more work shows in Chapter 7 of her book *Ten Lectures on Wavelets* that asymptotically for large N , the scaling function for the Daubechies wavelet of order N is of class $C^{\mu n}$ with $\mu = \frac{3}{4} \frac{\log 3}{\log 2} - 1 \approx .1887$.

Anyway, Daubechies wavelets can have as many derivatives as we like. But it turns out that no such wavelet can have infinitely many. This fact will be a corollary of the following proposition.

Proposition 10.47. Suppose that ψ is a compactly supported continuous function on \mathbb{R} such that the set of functions $\{2^{j/2}\psi(2^j x - k)\}_{j,k \in \mathbb{Z}}$ is an orthogonal set. If ψ is of class C^m , then $\int_{\mathbb{R}} x^l \psi(x) dx = 0$ for $0 \leq l \leq m$.

PROOF. We write $\psi^{(0)} = \psi, \psi^{(1)}, \dots, \psi^{(m)}$ for the successive derivatives, and we introduce successive integrals inductively by the formula

$$\psi^{(-l)}(x) = \int_{-\infty}^x \psi^{(-l+1)}(t) dt \quad \text{for } 1 \leq l \leq m.$$

We prove by induction on l for $0 \leq l \leq m$ that $\int_{\mathbb{R}} x^l \psi(x) dx = 0$.

The case $l = 0$ makes use of the assumed orthogonality. Let $a = k/2^j$ be an arbitrary dyadic rational number. We do not necessarily assume that k is an odd integer. Then

$$0 = \int_{\mathbb{R}} \psi(x) \overline{\psi(2^j x - k)} dx = \int_{\mathbb{R}} \psi(x) \overline{\psi(2^j(x - a))} dx,$$

and the change of variables $x = a + x'2^{-j}$ yields

$$0 = \int_{\mathbb{R}} \psi(a + x'2^{-j}) \overline{\psi(x')} dx'. \quad (*)$$

In this expression we can let j tend to $+\infty$, since we have not assumed that k is odd. Then dominated convergence yields the equality $0 = \psi(a) \int_{\mathbb{R}} \psi(x') dx'$. Either $\int_{\mathbb{R}} \psi(x) dx = 0$ or $\psi(a) = 0$ for all a , in which case $\int_{\mathbb{R}} \psi(x) dx = 0$ by the assumed continuity of ψ . This completes the argument for $l = 0$. It also shows that $\psi^{(-1)}(x)$ has compact support.

Assume inductively that $0 \leq l < m$ and that $\int_{\mathbb{R}} x^l \psi(x) dx = 0$ and that $\psi^{(0)}, \dots, \psi^{(-l-1)}$ have compact support. Integrating $(*)$ by parts l times is allowable since with each integration, both functions in the integrand have compact support, and we obtain

$$0 = \int_{\mathbb{R}} \psi^{(l+1)}(a + x2^{-j}) \overline{\psi^{(-l-1)}(x)} dx.$$

Letting j tend to $+\infty$ as above, we obtain $\psi^{(l+1)}(a) \int_{\mathbb{R}} \overline{\psi^{(-l-1)}(x)} dx = 0$ for all a . We cannot have $\psi^{(l+1)}(a) = 0$ for all a , since the continuity of $\psi^{(l+1)}$ would force ψ to be a polynomial and that is not the case. Thus we obtain

$$\int_{\mathbb{R}} \psi^{(-l-1)}(x) dx = 0. \quad (**)$$

This shows that $\psi^{(-l-2)}$ has compact support and completes one part of the inductive step.

We now integrate $(**)$ by parts, differentiating the integrated ψ factor and integrating a complementary power of x . After one such integration we obtain $\int_{\mathbb{R}} x \psi^{(-l)}(x) dx = 0$. After a total of l such integrations by parts, we have $\int_{\mathbb{R}} x^l \psi^{(-1)}(x) dx = 0$. Finally we integrate by parts once more, obtaining $\int_{\mathbb{R}} x^{l+1} \psi(x) dx = 0$. This completes the induction and the proof. \square

Corollary 10.48. If ψ is a compactly supported continuous function on \mathbb{R} such that the set of functions $\{2^{j/2} \psi(2^j x - k)\}_{j,k \in \mathbb{Z}}$ is an orthogonal set, then ψ cannot be of class C^∞ unless $\psi = 0$.

PROOF. If ψ is a compactly supported C^∞ function on \mathbb{R} such that the set of functions $\{2^{j/2} \psi(2^j x - k)\}_{j,k \in \mathbb{Z}}$ is an orthogonal set, then $\int_{\mathbb{R}} x^m \psi(x) dx = 0$ for all $m \geq 0$, according to Proposition 10.47, and therefore $\int_{\mathbb{R}} p(x) \psi(x) dx = 0$ for every polynomial p . By the Weierstrass Approximation Theorem (Theorem 1.52 of *Basic*), choose a sequence $\{p_n\}$ of polynomials converging uniformly to $\overline{|\psi|}$ on the support of ψ . Then $\{p_n \psi\}$ tends uniformly to $|\psi|^2$ on the support of ψ , and it follows that $\int_{\mathbb{R}} |\psi(x)|^2 dx = 0$. Therefore $\psi = 0$. \square

It is time to take stock of where we are. We have constructed a number of families of wavelets, often by applying some general theory, and we have seen that each of these families has certain properties, some desirable and some undesirable. We summarize this information in the table in Figure 10.18. In the table, ψ has the same decay and smoothness qualitatively as φ does. The expression “jump” points to the presence of a jump discontinuity, while “compact supp.” means that the indicated function has compact support and “Schwartz” means that the function is in the Schwartz class \mathcal{S} . A function on \mathbb{R} is **real analytic** if it is the restriction to \mathbb{R} of an analytic function on an open subset of \mathbb{C} that contains \mathbb{R} .

Family	φ decay	$\mathcal{F}\varphi$ decay	φ smoothness	$\mathcal{F}\varphi$ smoothness
Haar	compact supp.	$\leq c/ y $	jump	real analytic
Shannon	$\leq C/ x $	compact supp.	real analytic	jump
Meyer, index m	$\leq C x ^{m+2}$	compact supp.	real analytic	C^m
Meyer, index ∞	Schwartz	compact supp.	real analytic	C^∞
Battle–LeMarié, deg. 1	exponential	$\leq c/ y ^2$	C^0	real analytic
Battle–LeMarié, deg. m	exponential	$\leq c y ^{m+1}$	C^{m-1}	real analytic
Daubechies, order 1	compact supp.	$\leq c/ y $	jump	real analytic
Daubechies, order N	compact supp.	$\leq c/ y ^{n(N)}$	$C^{n'(N)}$	real analytic

FIGURE 10.18. Summary of properties of constructed wavelets.

11. A Quick Introduction to Applications

If it were not for the usefulness of wavelets in applications, the subject of wavelets might have remained something known only to experts in one corner of mathematics. But there are by now applications in many areas of science and engineering, even in areas of social science, and the subject cannot be ignored by a well educated mathematician. Not only are there applications, but also the applications have in many cases driven the theory. In this section we shall list some areas where wavelets have been useful, and we shall give a few details for some of them.

As we often saw throughout the theoretical development, the hypotheses on wavelets that we were accustomed to were not exactly the hypotheses that were needed for new steps. This phenomenon persists with applications, as we shall see. Let us distinguish two situations, corresponding to one and two dimensions.

In one dimension the objective is to analyze some function f in $L^2(\mathbb{R})$. It will be convenient to think of the domain variable as representing time and f as being some kind of signal. The orthogonal wavelets that we have studied are in many practical cases a suitable tool for the analysis of f . We fix a wavelet ψ that comes

from a scaling function φ , and just as we did with the Haar wavelet, we introduce the corresponding **discrete wavelet transform**, which carries f to the system $\{(f, \psi_{j,k})\}_{j,k \in \mathbb{Z}}$ of inner products of f with the members of the orthonormal basis $\{\psi_{j,k}\}$. We can think of these inner products as the wavelet coefficients. As with the Haar wavelet, we are really interested in a one-sided **wavelet expansion** of the form

$$f(x) = \sum_{k \in \mathbb{Z}} \left(\int_{\mathbb{R}} f(y) \overline{\varphi_{0,k}(y)} dy \right) \varphi_{0,k}(x) + \sum_{j=0}^{\infty} \sum_{k \in \mathbb{Z}} \left(\int_{\mathbb{R}} f(y) \overline{\psi_{j,k}(y)} dy \right) \psi_{j,k}(x).$$

In effect this expansion groups all the contributions from the $\psi_{j,k}$ with $j < 0$ into the first term. This expansion represents a process of looking at f with an infinite system of finer and finer resolutions. The first term gives the result of using an initial resolution corresponding to $j = 0$. New terms in the approximating expansion represent taking into account higher and higher resolutions, thus providing better and better knowledge of what is happening in the time domain. In short, the new terms represent the detail in the signal. Changing k represents changing the center of the interval of time on which we are concentrating; increasing j represents increasing the resolution. Experts in signal processing think of the process as one of passing the signal through a sequence of filters. Barbara Hubbard explains matters in the following way in her book:²⁹

Mathematicians classify functions in all kinds of ways. The viewpoint of signal processors is simpler: to them, a function is either a signal to be analyzed or a filter with which to analyze a function. A classical filter is an electric circuit with one wire that carries a signal in and another wire that carries a signal out. But a filter can also be a function (or, if it is digital, a sequence of numbers). The effect of a filter, whether physical or abstract, is easier to understand in Fourier space: the Fourier transform of the signal is multiplied by the Fourier transform of the filter, letting certain frequencies pass through while blocking others.

If, for example, the Fourier transform of the filter is almost 1 near zero, and almost 0 everywhere else . . . , the signal's low frequencies will survive this multiplication by 1, but the high frequencies will be essentially eliminated. This is a low-pass filter. The result in "physical" space is to smooth the signal: the small variations given by the high frequencies disappear, leaving the general tendency. . . .

Mallat [the person who formally introduced multiresolution analyses] realized that one can incorporate wavelets into a system that uses a cascade of filters to decompose a signal. Each resolution has its own pair of filters: a low-pass filter associated with the scaling

²⁹*The World According to Wavelets*, second edition, pp. 166–167.

function, giving an overall picture of the signal, and a high-pass filter associated with the wavelet, letting through only the high frequencies associated with the details. The two filters complement each other; that which one blocks, the other lets through. (Of course “high” or “low” frequencies are relative. The low frequencies encoded by the low-pass filter at a fine resolution may be higher than the high frequencies encoded by the high-pass filter at a coarse resolution.)

In quantitative terms the process described by Hubbard is as follows: For each index j , let P_j be the orthogonal projection of $L^2(\mathbb{R})$ on V_j , and let Q_j be the orthogonal projection on W_j . Then we have $P_j f = P_{j-1} f + Q_{j-1} f$ and $P_{j-1} f = P_{j-2} f + Q_{j-2} f$ and so on, with the result that

$$P_J f = P_0 f + Q_{J-1} f + Q_{J-2} f + \cdots + Q_1 f + Q_0 f.$$

We shall come back to this decomposition shortly when we discuss the discrete wavelet transform in more detail.

For many purposes one wants to chop off the expansion at some point by dropping small terms. This is already what we did above in passing from f to $P_J f$. The same kind of chopping would be the simplest thing to do if one were trying to compress the signal or counteract the effect of noise. Meyer³⁰ says the following about this process:

The most astonishing result we obtain will be the remarkable fact that “full” wavelet series (those having plenty of non-zero coefficients) represent really pathological functions, whereas “normal” functions have “sparse” or “lacunary” wavelet series. On the other hand, Fourier series of the usual functions are “full,” whereas lacunary Fourier series represent pathological functions.

This phenomenon has a simple explanation. Analysis by wavelets is a local Fourier analysis which takes place at every scale. It has the advantage of being concentrated near the singular support of the function analyzed. In other words, away from the singular support, the function analyzed is infinitely differentiable and the corresponding wavelet coefficients are negligible.

The book by Burris, Gopinath, and Guo³¹ has some interesting graphs giving an example of how this works in practice. The authors have created a one-dimensional signal out of the Houston skyline, and they show how the signal is

³⁰*Wavelets and Operators*, p. 113. Meyer makes this statement in a specific context, which is a little different from ours, but that distinction will not deter us.

³¹See the Selected References.

decomposed when the discrete wavelet transform is applied using the Daubechies wavelet³² of order 4.

Other applications use this and other wavelets. As a rule, authors tend not to explain how they came to use one particular wavelet rather than another. The wavelets in use tend to be the Meyer wavelets with index ≤ 3 , the Battle–Lamarié wavelets of degree ≤ 3 , and the Daubechies wavelets of order ≤ 6 . Occasionally an author will use some other kind of wavelet for some particular purpose. Some of the applications that have been discussed in print are the following:

- (a) Automatic analysis of an electrocardiogram. This is discussed in the book by Louis, Maass, and Rieder, pp. 232ff. The objective is to automate the obvious diagnoses of irregular heartbeats, leaving a more careful analysis to a human being. The questions are whether the rhythm of the cardiac valve is in synchronization with that of the heart muscle and whether the heart muscle relaxes between beats. The Daubechies wavelet of order 2 is used for this purpose.
- (b) Speech storage. Speech takes a great deal of computer memory to store. Imagine that one wanted to store the content of all telephone calls worldwide that might be of national security interest. One wants a way of compressing the speech without making it unintelligible.
- (c) Music storage. Music takes a great deal of space to store but for different reasons from speech. One has to handle a greater range of frequencies without losing subtle techniques of the performers.
- (d) Speech recognition. The idea is to use wavelet analysis to identify phonemes from a signal representing speech.
- (e) Hearing aids for understanding speech. Modern hearing aids are capable of doing a complicated nonlinear analysis and synthesis of speech, amplifying part of a signal and suppressing another part, in order to make speech more recognizable to a patient using a hearing aid. Simple amplification is not enough. The usual difficulty that a patient has in hearing is an inability to distinguish among certain consonants, and the processing of the signal is supposed to emphasize those features that the patient needs in order to recognize what is being said, all the while eliminating background noise. Smoothing of the signal is definitely not what is called for; smoothed speech sounds largely like vowels, and the difficulty in recognizing consonants is aggravated if speech is smoothed.³³
- (f) Applications in economics. Wavelet analysis can reveal relationships between economic variables and indicate how those relationships evolve with time.

³²This is in Section 2.7 of the book. There are two standard ways of naming the Daubechies wavelets—by the order N and by the number of nonzero coefficients $2N$ in the scaling equation.

³³There is a problem with being too specific about how particular hearing aids work in that a certain amount of the information is proprietary and therefore unpublished and unavailable.

- (g) Applications in finance. Economic variables affect markets according to various time scales, short term and medium term, for example. Some are leading indicators, and some are lag indicators. In principle wavelets decompose time series data into different scales and can reveal relationships that are not obvious in the aggregate data.

Let us come back to the discrete wavelet transform. Calculating a one-sided wavelet expansion as at the beginning of this section looks as if it involves a great many integrals. However, these integrals are related to one another by the scaling equation and the wavelet equation, and matters are not so complicated. As indicated with the Hubbard quotation, we are to think of the goal as forming $P_J f$ with J chosen large enough so that $\|f - P_J f\|_2$ is small.³⁴ Write $\varphi_{j,k}(x) = 2^{j/2} \varphi(2^j x - k)$ for each integer j and k . For fixed j , these functions form an orthonormal basis of V_j , and we write $c_{j,k}$ for the coefficient in the expansion of f in this basis:

$$c_{j,k} = (f, \varphi_{j,k}) = \int_{\mathbb{R}} f \overline{\varphi_{j,k}} dx.$$

We write \mathbf{c}_j for the square-summable sequence $\{c_{j,k}\}_{k \in \mathbb{Z}}$.

To be systematic, we shall introduce an algorithm of “decomposition” of \mathbf{c}_j and an algorithm of “reconstruction” of \mathbf{c}_j . Each of these makes use of the two functions $m_0(y)$ and $m_1(y)$ that we have carried along ever since Theorem 10.10. The function $m_0(y)$ was introduced just before the statement of that theorem in terms of the scaling equation

$$\varphi(x) = \sum_{k=-\infty}^{\infty} a_k \sqrt{2} \varphi(2x - k), \quad \text{where } a_k = (\varphi, \varphi_{1,k}),$$

the definition being

$$m_0(y) = \frac{1}{\sqrt{2}} \sum_{k=-\infty}^{\infty} a_k e^{-2\pi iky}.$$

The function $m_1(y) = e^{2\pi iy} \overline{\nu(y) m_0(y + \frac{1}{2})}$ was introduced just after the statement of the theorem and involved the wavelet equation

$$\psi(x) = \sum_{k=-\infty}^{\infty} b_k \sqrt{2} \varphi(2x - k), \quad \text{where } b_k = (\psi, \varphi_{1,k}).$$

Its formula was

$$m_1(y) = \frac{1}{\sqrt{2}} \sum_{k=-\infty}^{\infty} b_k e^{-2\pi iky}.$$

In this formula the coefficients b_k are related to the coefficients a_k . The exact relationship depends on the choice of the function $\nu(y)$, but we saw, for example, that if $\nu(y) = 1$, then $b_k = (-1)^{k+1} \overline{a_{-k-1}}$.

³⁴From a theoretical standpoint this norm can be estimated with the aid of Lemma 10.16.

The above formulas relate matters in V_1 to those in V_0 . Let us see the relationship between V_j and V_{j-1} . We have

$$\begin{aligned}\varphi_{j-1,k}(x) &= 2^{(j-1)/2}\varphi(2^{j-1}x - k) = 2^{(j-1)/2}\varphi\left(\frac{1}{2}(2^j x - 2k)\right) \\ &= 2^{(j-1)/2} \sum_{l=-\infty}^{\infty} a_l \sqrt{2} \varphi(2^j x - 2k - l) \\ &= \sum_{l=-\infty}^{\infty} a_l 2^{j/2} \varphi(2^j x - 2k - l) \\ &= \sum_{l=-\infty}^{\infty} a_l \varphi_{j,2k+l}(x)\end{aligned}$$

Similarly

$$\psi_{j-1,k}(x) = \sum_{l=-\infty}^{\infty} b_l \varphi_{j,2k+l}(x).$$

For the **decomposition algorithm**, we substitute the relationship between $\varphi_{j-1,k}$ and the $\varphi_{j,2k+l}$ into the definition of the coefficient $c_{j-1,k}$. Then we obtain

$$c_{j-1,k} = (f, \varphi_{j-1,k}) = \left(f, \sum_{l=-\infty}^{\infty} a_l \varphi_{j,2k+l}\right) = \sum_{l=-\infty}^{\infty} \overline{a_l} c_{j,2k+l} = \sum_{l=-\infty}^{\infty} \overline{a_{l-2k}} c_{j,l}$$

If we define coefficients $d_{j,k}$ by $d_{j,k} = (f, \psi_{j,k})$, then we similarly have

$$d_{j-1,k} = (f, \psi_{j-1,k}) = \left(f, \sum_{l=-\infty}^{\infty} b_l \varphi_{j,2k+l}\right) = \sum_{l=-\infty}^{\infty} \overline{b_l} c_{j,2k+l} = \sum_{l=-\infty}^{\infty} \overline{b_{l-2k}} c_{j,l}.$$

Then one step of the decomposition algorithm is the passage from the system of coefficients $\{c_{j,k}\}_{k \in \mathbb{Z}}$ to the systems $\{c_{j-1,k}\}_{k \in \mathbb{Z}}$ and $\{d_{j-1,k}\}_{k \in \mathbb{Z}}$ by the *same* operation. To make this step more transparent, let us extend our definition of \mathbf{c}_j above by giving names to all of our various square-summable sequences:

$$\mathbf{a} = \{a_l\}_{l \in \mathbb{Z}} \quad \text{and} \quad \mathbf{b} = \{b_l\}_{l \in \mathbb{Z}},$$

$$\mathbf{a}^{\text{tr}} = \{a_{-l}\}_{l \in \mathbb{Z}} \quad \text{and} \quad \mathbf{b}^{\text{tr}} = \{b_{-l}\}_{l \in \mathbb{Z}},$$

and with j fixed,

$$\mathbf{c}_j = \{c_{j,k}\}_{k \in \mathbb{Z}} \quad \text{and} \quad \mathbf{d}_j = \{d_{j,k}\}_{k \in \mathbb{Z}}.$$

Then \mathbf{c}_{j-1} is obtained from \mathbf{c}_j by convolving with the sequence $\overline{\mathbf{a}}^{\text{tr}}$ and retaining only the even-numbered entries. Similarly \mathbf{d}_{j-1} is obtained from \mathbf{c}_j by convolving

with the sequence $\bar{\mathbf{b}}^{\text{tr}}$ and retaining only the even-numbered entries. Iterating this step, starting at \mathbf{c}_J , allows us to pass from the sequence \mathbf{c}_J to the system of sequences $\mathbf{d}_{J-1}, \mathbf{d}_{J-2}, \dots, \mathbf{d}_0, \mathbf{c}_0$.

The **reconstruction algorithm** will pass from the system of sequences $\mathbf{d}_{J-1}, \mathbf{d}_{J-2}, \dots, \mathbf{d}_0, \mathbf{c}_0$ to the sequence \mathbf{c}_J . To understand matters, it is enough to carry out one step of the algorithm, namely to pass from \mathbf{c}_{j-1} and \mathbf{d}_{j-1} to \mathbf{c}_j . The relevant formula in terms of projections is

$$P_j f = P_{j-1} f + Q_{j-1} f,$$

which we write out as

$$\sum_{k \in \mathbb{Z}} (f, \varphi_{j,k}) \varphi_{j,k} = \sum_{k \in \mathbb{Z}} (f, \varphi_{j-1,k}) \varphi_{j-1,k} + \sum_{k \in \mathbb{Z}} (f, \psi_{j-1,k}) \psi_{j-1,k},$$

hence as

$$\begin{aligned} \sum_{k \in \mathbb{Z}} c_{j,k} \varphi_{j,k} &= \sum_{k \in \mathbb{Z}} c_{j-1,k} \varphi_{j-1,k} + \sum_{k \in \mathbb{Z}} d_{j-1,k} \psi_{j-1,k} \\ &= \sum_{k \in \mathbb{Z}} c_{j-1,k} \left(\sum_{l \in \mathbb{Z}} a_l \varphi_{j,2k+l} \right) + \sum_{k \in \mathbb{Z}} d_{j-1,k} \left(\sum_{l \in \mathbb{Z}} b_l \varphi_{j,2k+l} \right) \\ &= \sum_{l \in \mathbb{Z}} \sum_{k \in \mathbb{Z}} (c_{j-1,k} a_{l-2k} + d_{j-1,k} b_{l-2k}) \varphi_{j,l}. \end{aligned}$$

Since the functions $\varphi_{j,l}$ are an orthonormal basis of V_j , we obtain

$$c_{j,l} = \sum_{k \in \mathbb{Z}} (c_{j-1,k} a_{l-2k} + d_{j-1,k} b_{l-2k}),$$

which is a formula for recovering \mathbf{c}_j from \mathbf{c}_{j-1} and \mathbf{d}_{j-1} .

Both sums in the expression for $c_{j,k}$ can be viewed as convolutions, but they are more subtle than the ones in the decomposition algorithm. To see them as convolutions, define

$$\tilde{c}_{j-1,n} = \begin{cases} c_{j-1,n/2} & \text{if } n \text{ is even} \\ 0 & \text{if } n \text{ is odd,} \end{cases}$$

and let $\tilde{\mathbf{c}}_{j-1} = \{\tilde{c}_{j-1,n}\}_{n \in \mathbb{Z}}$. Define $\tilde{d}_{j-1,n}$ and $\tilde{\mathbf{d}}_{j-1}$ similarly. Then \mathbf{c}_j is the sum of two terms; the first is the convolution of $\tilde{\mathbf{c}}_{j-1}$ and \mathbf{a} , and the second is the convolution of $\tilde{\mathbf{d}}_{j-1}$ and \mathbf{b} .

We conclude this discussion of the one-dimensional case with some general remarks.

In the language of signal processing, the decomposition algorithm and the reconstruction algorithm are the analysis and synthesis steps of a scheme of “sub-band filtering with exact reconstruction.” The point is to do some compression or other processing between the decomposition and reconstruction steps. The decomposition step draws attention to terms that are candidates for dropping without the loss of too much information, and then one drops those terms. The reconstruction step is applied to the terms that remain. Here the theory has built this idea from signal processing into a mathematical transform that isolates features of a signal that are important.

In practice a given signal will often be given by discrete pulses obtained by sampling. To make the discrete pulses into a function on \mathbb{R} , one defines the signal to be constant or perhaps linear over each interval between sampling points. In this situation the Shannon Sampling Theorem (Proposition 10.3) indicates that there is an upper limit to how much resolution will contain useful information. We omit the details.

Let us turn our attention to two dimensions. In two dimensions the objective is to analyze some square integrable function f on \mathbb{R}^2 . Let us think of this function as representing a visual image. If the image is in black-and-white, then the function is scalar valued. If it is in color, then it is vector-valued. The usual thing is to make the vectors be three-dimensional. Initially the three dimensions for color can be regarded as representing the intensity of three colors; red, green, and blue are one choice. We return to this matter in a moment.

We shall concentrate on two situations:

- (i) compression and storage of fingerprints, and
- (ii) traditional JPEG compression of images from digital cameras and the wavelet version, JPEG 2000.

In terms of multiresolution analysis, proceeding in the setting of \mathbb{R}^2 is not fundamentally more complicated than proceeding in the setting of \mathbb{R}^1 . The idea is that one can use a kind of completed tensor product to convert one-variable data into two-variable data. Thus for example, if φ and $\{V_j\}$ define a multiresolution analysis in one dimension, then the set of functions $\{x \mapsto \varphi(x - k)\}_{k \in \mathbb{Z}}$ is an orthonormal basis of V_0 . For the two-dimensional setting the corresponding orthonormal basis is $\{(x, y) \mapsto \varphi(x - k)\varphi(y - l)\}_{k, l \in \mathbb{Z}}$, and one calls the space $V_0 \tilde{\otimes} V_0$. The spaces $V_j \tilde{\otimes} V_j$ are obtained as usual by dilation. The details will not be of concern to us.

What is of more significance is that for some reason, the human brain seems especially sensitive to visual asymmetries. When one goes through the process of decomposition, compression, and reconstruction for a visual image by the process that was just described, the use of a real-valued wavelet ψ that lacks

symmetry about an axis turns out to be noticeable. As it happens, all Daubechies wavelets other than the Haar wavelet fail to be symmetric or antisymmetric about any vertical axis, and in fact the same thing is true in all real-valued compactly supported cases except in the Haar case.³⁵ The effect is that one has to enlarge the theory that we have presented to allow wavelets that are not orthogonal. It is enough to use “biorthogonal wavelets,” which use two scaling functions that are related in a certain way. This expansion of the theory will take us too far afield, and thus we omit it.

However, we can mention the name of the best known family of biorthogonal wavelets, namely the Cohen–Daubechies–Feauveau family. The two members of the family that are most used have indices $5/3$ and $9/7$, and for current purposes we need not know what these indices refer to; the one with indices $5/3$ is for compression with no loss of information, and the one with indices $9/7$ is for compression that allows loss of information.

Now let us come to the two situations mentioned above. First let us consider fingerprints.³⁶ As of 1995 the database of fingerprints maintained by the Federal Bureau of Investigation contained more than 200 million records, and there was a need for computerizing these records, which were all in the form of inked impressions on cards, one card per person. Taking a full uncompressed 8-bit gray-scale digital image at a resolution of 500 dots per inch would have required too much computer storage, and a system for compressing digital images was sought that would be accurate enough to make the distinctions that one could traditionally make by hand if given enough time. A group set up to investigate the situation found that the JPEG method used in digital cameras unavoidably adds faint horizontal and vertical lines to the images in certain places if the compression ratio is at least 10 to 1, and that feature was unacceptable. After trying a number of other possibilities, the group settled on some guidelines in 1997. In principle these guidelines could be met by a number of wavelets, and initially the one put in use was the Cohen–Daubechies–Feauveau $9/7$ wavelet. That choice seemed to produce reliable images even after a process that involved 15 to 1 compression.

Finally we consider JPEG and JPEG 2000 for the compression and storage of photographic and other images.³⁷ For each we treat black-and-white images first and then color images.

Of the two systems, JPEG is the conceptually simpler one. It uses classical Fourier analysis rather than wavelets, but it still has steps of decomposition, compression, and reconstruction. It works independently on 8-by-8 blocks of pixels, doing an analysis on each one. The transform at the decomposition stage is a version of Fourier series that avoids complex numbers. Within the classical treatment of Fourier series, a Fourier cosine expansion is obtained for functions on

³⁵The result in question is Theorem 8.1.4 of the book by Daubechies in the Selected References.

³⁶The article by Brislawn listed in the Selected References is a readable expository account.

³⁷The two items by Austin listed in the Selected References are readable expository accounts. See the article by Rabbabi and Joshi for more detail about JPEG 2000.

$[0, \pi]$ by extending the functions to be even functions on $[-\pi, \pi]$ that are periodic of period 2π ; if the Fourier series is written out with cosines and sines in place of complex exponentials, the sine terms drop out, and the desired series results. In our situation our function is defined at 8 points, and we think of extending it to be defined on 16 points so as to be even. In defining the Fourier cosine expansion, there is a choice how the 16 points are to be distributed in the given interval, and the particular choice that is made in the case of JPEG is what is sometimes called the discrete cosine transform of type II. If the given interval were $[0, \pi]$, doubled to $[-\pi, \pi]$, this particular choice of transform would visualize $[0, \pi]$ as divided into 8 equal pieces, and then the midpoint of each piece would be used. Thus the points for evaluation of a function h would be the points $\pi(2x + 1)/16$ with $0 \leq x \leq 7$, and functions on these points would be expanded as linear combinations of the functions $\cos[\pi(2x + 1)u/16]$ with $0 \leq u \leq 7$. For our application we abbreviate the cumbersome $h(\pi(2x + 1)/16)$ as $f(x)$, and we expand $f(x)$ in terms of the functions $\cos[\pi(2x + 1)u/16]$ with $0 \leq u \leq 7$.

Using the formula $\cos A \cos B = \frac{1}{2}(\cos(A + B) + \cos(A - B))$, we readily check that the eight functions of x given by $\cos[\pi(2x + 1)u/16]$ with $0 \leq u \leq 7$ are orthogonal in the sense that

$$\sum_{x=0}^7 \cos[\pi(2x + 1)u/16] \cos[\pi(2x + 1)u'/16] = 0 \quad \text{for } u \neq u'.$$

Hence they are linearly independent and form a basis of an 8-dimensional vector space. As to their normalization, $\sum_{x=0}^7 \cos^2[\pi(2x + 1)u/16]$ equals 8 if $u = 0$ and equals 4 if $1 \leq u \leq 7$. Thus the system of functions

$$\left\{ \frac{1}{2}C(u) \cos[\pi(2x + 1)u/16] \right\}_{u=0}^7$$

is an orthonormal basis of our space of functions of x if $C(u)$ is defined to be 1 for $1 \leq u \leq 7$ and to be $1/\sqrt{2}$ for $u = 0$. The **discrete cosine transform** is the passage from f to the system of coefficients F of f in this basis. Specifically in terms of f we let

$$F(u) = \frac{1}{2}C(u) \sum_{x=0}^7 f(x) \cos[\pi(2x + 1)u/16],$$

and we recover f from F by the formula

$$f(x) = \frac{1}{2} \sum_{u=0}^7 C(u)F(u) \cos[\pi(2x + 1)u/16].$$

For the application to JPEG, the 8-by-8 block of pixels in a photographic image is a function $f(x, y)$ of two variables x and y , and we do a discrete cosine transform in each variable. The result is the function $F(u, v)$ given by

$$F(u, v) = \frac{1}{4}C(u)C(v) \sum_{x=0}^7 \sum_{y=0}^7 f(x, y) \cos[\pi(2x+1)u/16] \cos[\pi(2y+1)v/16],$$

and we recover $f(x, y)$ by the inversion formula

$$f(x, y) = \frac{1}{4} \sum_{u=0}^7 \sum_{v=0}^7 C(u)C(v)F(u, v) \cos[\pi(2x+1)u/16] \cos[\pi(2y+1)v/16].$$

The above formula for $F(u, v)$ takes care of the decomposition algorithm except for the question of its fast implementation, which will not concern us. The next step is the compression algorithm. A naive approach would be to chop off higher frequencies, but there are two problems. One is that there are not many frequencies in this analysis, and the other is that such a chopping process would introduce Gibbs phenomenon. Instead, one goes through a process that involves linear combinations of frequencies.

This consists of a step of “quantization” or rounding off, followed by an invertible packaging step that will not concern us. Part of the input to the JPEG process is a quality parameter q with $1 \leq q \leq 100$. This parameter is converted to another number α by the formula

$$\alpha = \begin{cases} \frac{50}{q} & \text{if } 1 \leq q \leq 50, \\ 2 - \frac{50}{q} & \text{if } 50 \leq q \leq 100. \end{cases}$$

Data on human perception leads to the definition of a matrix Q with rows and columns numbered from 0 to 7 and given by³⁸

$$Q = \begin{pmatrix} 16 & 11 & 10 & 16 & 24 & 40 & 51 & 61 \\ 12 & 12 & 14 & 19 & 26 & 58 & 60 & 55 \\ 14 & 13 & 16 & 24 & 40 & 57 & 69 & 56 \\ 14 & 17 & 22 & 29 & 51 & 87 & 80 & 62 \\ 18 & 22 & 37 & 56 & 68 & 109 & 103 & 77 \\ 24 & 35 & 55 & 64 & 81 & 104 & 113 & 92 \\ 49 & 64 & 78 & 87 & 103 & 121 & 120 & 101 \\ 72 & 92 & 95 & 98 & 112 & 100 & 103 & 99 \end{pmatrix}.$$

In the quantizing step, we replace the 64 real numbers $F(u, v)$ by the 64 integers $\text{round}(F(u, v)/(\alpha Q(u, v)))$, where “round” refers to the nearest integer. The

³⁸The exact matrix appears in the JPEG standard as a matter of information, not as a requirement. The article by Wallace in the Selected References includes an example of what happens to some given data when this matrix is used and α equals 1.

effect of this step is to replace all of the numbers $F(u, v)$ by integers, most of which are 0. Instead of recording each zero, the algorithm records the number of zeros. It is here that space is saved. After the invertible packaging step, the data can be saved.

For the reconstruction algorithm one reverses the steps—unpackaging, unquantizing (i.e., multiplication of entries by $\alpha Q(u, v)$), and inversion of the discrete cosine transform.

For color images the main difference with the black-and-white case is that the functions in question have values that are 3-component vectors rather than real numbers. The three components could correspond to the red, green, and blue components, but it is customary to use certain linear combinations of these instead. These are called luminance Y , blue chrominance C_b , and red chrominance C_r . The relationship is given by³⁹

$$\begin{pmatrix} Y \\ C_b \\ C_r \end{pmatrix} = \begin{pmatrix} 0.29900 & 0.58700 & 0.11400 \\ -0.16874 & -0.33126 & 0.50000 \\ 0.50000 & -0.41869 & -0.08131 \end{pmatrix} \begin{pmatrix} R \\ G \\ B \end{pmatrix}.$$

Then one goes through the same steps as above, using suitable matrices Q for each component. The matrix Q for the luminance is the one given above, but the matrices Q for the chrominance components are different.

The ingredients for JPEG 2000 are based on those for JPEG but are more complicated. The distinction between black-and-white as involving scalar-valued functions and color as involving vector-valued functions persists, and in the latter case one still uses luminance, blue chrominance, and red chrominance. The processing involves decomposition, compression, and reconstruction just as before, but there is also a step of preprocessing. As before, we ignore the packaging step, which is more complicated than before.

The preprocessing step consists first of a decision about how to partition the input image into rectangular and nonoverlapping tiles (except possibly for the tiles at the image borders). These can be as large as the original image itself or as small as a single pixel. The various tiles are processed independently. There are other aspects to the preprocessing, but we ignore them.

For the decomposition a discrete wavelet transform is used, the same transform in each variable. As was mentioned earlier, orthogonal wavelets are not suitable in the wavelet transform for a visual image. Instead, biorthogonal wavelets are used. These have different scaling functions and wavelets for the decomposition and reconstruction stages. Thinking in terms of the wavelet transform as given by filters, one speaks of using a pair of filter banks (one for decomposition and one for reconstruction) rather than just one. The two that are mentioned in the article by Rabbani and Joshi are the Cohen–Daubechies–Feauveau 5/3 biorthogonal

³⁹An adjustment is made to force the chrominance components to be ≥ 0 , but we omit this part.

wavelet⁴⁰ and the Cohen–Daubechies–Feauveau 9/7 biorthogonal wavelet. To describe either of these, one has only to give the coefficients of the two generating functions. They are integers in the first case and are merely real numbers in the second case. The coefficients are written down explicitly in the Rabbani–Joshi article.

For the compression stage the idea is to drop low-pass terms beyond a certain threshold. This is done with the aid of a “budget” for how many bits are to be allowed and an algorithm for comparing the distortion that results from the various choices.

BIBLIOGRAPHICAL REMARKS ABOUT CHAPTER X. In Section 1, Proposition 10.1 is taken from Chapter 3 of Debnath’s *Wavelet Transforms*, and Proposition 10.3 is taken from Chapter 2 of Daubechies’s *Ten Lectures on Wavelets*. Sections 2 through 10 are adapted from material in the following chapters of books listed in the Selected References:

Section 2: Pinsky, Chapter 6.

Section 3: Daubechies, Chapter 5.

Section 4: Daubechies, Chapter 5; Hernandez–Weiss, Chapter 2.

Section 5: Daubechies, Chapter 5; Pinsky, Chapter 6.

Section 6: Daubechies, Chapters 4 and 5.

Section 7: Ahlfors, Chapter 5; Chui, Chapters 1 and 4; Daubechies, Chapter 5; Meyer, Chapter 2.

Section 8: Chui, Chapter 4.

Section 9: Daubechies, Chapter 6; Debnath, Chapter 7; Pinsky, Chapter 6.

Section 10: Daubechies, Chapter 7; Pinsky, Chapter 6.

The proof of Lemma 10.42 in Section 10 is from the note by N. D. Elkies listed in the Selected References. The proofs of the Paley–Wiener Theorem and its lemma in Section 10 are based on the Junior Paper of L. B. Pierce. Section 11 draws on the above books in the Selected References, as well as the expository articles by Austin and Brislawn and the books by Burris et al. and by Louis et al.

12. Problems

1. Find all Schwartz functions f on \mathbb{R} for which equality holds in the inequality of the Uncertainty Principle (Proposition 10.1). Assume that the mean values t_0 and ω_0 are 0.
2. Referring to the proof of the Shannon Sampling Theorem (Proposition 10.3), give an example of a nonzero continuous function f in $L^2(\mathbb{R})$ such that $f(k) = 0$ for every integer k and such that $\mathcal{F}f$ has compact support.

⁴⁰Rabbani and Joshi refer to the the Cohen–Daubechies–Feauveau 5/3 biorthogonal wavelet as the “LeGall (5,3) spline.”

3. Theorem 10.10b limits the wavelets ψ that can correspond to a given scaling function φ . The form of the most general such ψ allows for a periodic function $v(y)$ of period 1 with $|v(y)| = 1$ almost everywhere.
 - (a) Prove that if φ has compact support, then $v(y)$ is a trigonometric polynomial.
 - (b) Prove that if $v(y)$ is a trigonometric polynomial such that $|v(y)| = 1$ almost everywhere, then $v(y) = ce^{2\pi iny}$ for some integer n and some constant c with $|c| = 1$.
4. (a) Show that if $\{V_j\}$ and φ form a multiresolution analysis, then $\varphi^\#$ with $\varphi^\#(x) = \varphi(-x)$ is a scaling function for a suitable sequence of spaces $\{V_j^\#\}$, and identify the corresponding spaces $\{V_j^\#\}$. Why does it follow that $V_j^\# = V_j$ if $\varphi^\#$ is an integer translate of φ ?
 - (b) Show that the scaling function $\varphi^\#$ is an integer translate of φ in the cases of the Haar wavelet, the Shannon wavelet, the Meyer wavelets, and the Battle–Lemarié wavelets.
 - (c) In the case of the Daubechies wavelets of order ≥ 2 , the function $\varphi^\#$ is not an integer translate of φ . Nevertheless, show that $\varphi^\#$ arises in some way from the same kind of construction.
5. Let K be the interval $[-\frac{2}{3}, \frac{1}{3})$, and let φ be the indicator function of K . Prove that φ is the scaling function of a multiresolution analysis.
6. In connection with Proposition 10.38, define $m_0(y) = \frac{1}{2}(1 + e^{-4\pi iy})$.
 - (a) Define $h(y) = \prod_{j=1}^{\infty} m_0(2^{-j}y)$, and check that $h(y) = (1 - e^{-4\pi iy})/(4\pi iy) = (\mathcal{F}I_{[0,2]})(y)$.
 - (b) Verify that the integer translates of $\varphi = I_{[0,2]}$ do not form an orthonormal sequence. Conclude that hypothesis (iii) of Proposition 10.38 cannot be weakened to the point of allowing this particular trigonometric polynomial but still deducing that $\mathcal{F}^{-1}h$ is a scaling function.

Problems 7–12 concern the Haar system of Section 2. Let φ be the indicator function of $[0, 1)$, and define $\varphi_{j,k}(x) = 2^{j/2}\varphi(2^jx - k)$ as usual. The orthogonal projection of $L^2(\mathbb{R})$ on the closed linear span V_m of the subset $\{\varphi_{m,k}\}_{k \in \mathbb{Z}}$ of $L^2(\mathbb{R})$ is

$$(P_m f)(x) = \sum_{k \in \mathbb{Z}} \left(\int_{\mathbb{R}} f(y) \overline{\varphi_{m,k}(y)} dy \right) \varphi_{m,k}(x).$$

7. Why is $P_m f$ meaningful for all f in $L^1(\mathbb{R})$? For f in $L^1(\mathbb{R})$, why is $P_m f$ convergent to f in $L^1(\mathbb{R})$ as m tends to $+\infty$?
8. Give an example of an L^1 function for which $P_m f$ does not tend to 0 in $L^1(\mathbb{R})$ as m tends to $-\infty$.

9. Suppose that $f(t) = 1$ for $0 \leq t < 1/3$ and that $f(t) = 0$ elsewhere. Show that $\liminf_{m \rightarrow +\infty} P_m f(1/3) < \limsup_{m \rightarrow +\infty} P_m f(1/3)$, so that the Haar series of f diverges at the point $t = 1/3$. (By contrast the Fourier series of a function of bounded variation converges at every point.)
10. The Haar system of wavelets consists of the functions $\psi_{j,k}(x) = 2^{j/2} \psi(2^j x - k)$ on \mathbb{R} with j and k in \mathbb{Z} . Here $\psi(x)$ equals 1 for $0 \leq x < \frac{1}{2}$, equals -1 for $\frac{1}{2} \leq x < 1$, and equals 0 otherwise. Prove that the nonzero restrictions to $[0, 1)$ of φ and the functions $\psi_{j,k}$ with $j \geq 0$ together form an orthonormal basis of $L^2([0, 1])$.
11. The Haar scaling function φ satisfies $\varphi(x) = \varphi(2x) + \varphi(2x - 1)$ almost everywhere. By working with Fourier transforms, show that any function f in $L^1(\mathbb{R}) \cap L^2(\mathbb{R})$ with $f(x) = f(2x) + f(2x - 1)$ almost everywhere equals a multiple of $I_{[0,1]}(x)$ almost everywhere.
12. Let $\Phi(x) = I_{[-\frac{1}{2}, \frac{1}{2})}(x)$. Using the orthogonality of the functions $x \mapsto \Phi(2x - k)$ for k in \mathbb{Z} , show that Φ cannot satisfy an equation

$$\Phi(x) = \sum_{k \in \mathbb{Z}} a_k \Phi(2x - k) \quad \text{a.e.}$$

for complex constants a_k such that $\sum |a_k|^2 < \infty$.

Problems 13–17 concern the polynomial used in the construction of the Meyer wavelets in Section 6. Fix an integer $m \geq 1$. Construction of the Meyer wavelet of index m makes use of a C^m function ν on \mathbb{R} such that $\nu(x) = 0$ for $x \leq 0$, $\nu(x) = 1$ for $x \geq 1$, $\nu(y) + \nu(1 - y) = 1$ everywhere, and $\nu(x)$ equals a polynomial $P(x)$ for $0 \leq x \leq 1$. Define a polynomial $P(x)$ for current purposes to be “admissible” if it is divisible by x^{m+1} , has $P(1) = 1$, and has $P^{(k)}(1) = 0$ for $1 \leq k \leq m$.

13. Show that if P is usable as the polynomial in the definition of the Meyer wavelet of index m , then $P(x)$ is admissible.
14. Show that an admissible polynomial exists if and only if there exists an admissible polynomial of degree $\leq 2m + 1$, and in this case the admissible polynomial of degree $\leq 2m + 1$ is unique.
15. Show that an admissible polynomial P of the least possible degree necessarily satisfies $P(x) + P(1 - x) = 1$ for all x . Deduce that such a polynomial is usable as the polynomial in the definition of the Meyer wavelet of index m .
16. This problem establishes a certain formula for the alternating sum of products of two binomial coefficients. To do so, it combines a technique in the proof of Lemma 10.35 with the technique used in proving the “Vandermonde convolution” formula $\sum_{j=0}^n \binom{n}{j} \binom{m}{k-j} = \binom{n+m}{k}$ for binomial coefficients, namely of recognizing the two sides of the formula as the coefficient of x^k on the two sides of the equation $(1 + x)^n (1 + x)^m = (1 + x)^{n+m}$.

- (a) With m as above and with $p \leq m$, prove the formula

$$(1 - z)^{m+1} = \sum_{q=0}^p (-1)^{p-q} \binom{m+1}{p-q} z^{p-q} + [z^{p+1}],$$

where $[z^{p+1}]$ is an analytic function in a disk about $z = 0$ that is divisible by z^{p+1} .

- (b) With m and p as above, prove the formula

$$(1 - z)^{-(m+1)} = \sum_{k=0}^p \binom{m+k}{k} z^k + [z^{p+1}],$$

where $[z^{p+1}]$ is another analytic function in a disk about $z = 0$ that is divisible by z^{p+1} .

- (c) Taking the product of the results of (a) and (b), prove that

$$\sum_{q=0}^p (-1)^{p-q} \binom{m+1}{p-q} \binom{m+q}{q}$$

equals 1 if $p = 0$ and equals 0 if $0 < p \leq m$.

17. Let D be the differentiation operator on polynomials in one variable. If f and g are polynomials in x , the Leibniz rule says that

$$D^n(fg) = \sum_{k=0}^n \binom{n}{k} (D^{n-k}f)(D^k g).$$

- (a) With m as above and $p \leq m$, apply the Leibniz rule to compute D^p of the polynomial

$$P(x) = x^{m+1} \sum_{k=0}^m \binom{m+k}{k} (1-x)^k.$$

Then evaluate at $x = 1$, and obtain the identity

$$(D^p P)(1) = p! \sum_{q=0}^p (-1)^q \binom{m+1}{p-q} \binom{m+q}{q}.$$

- (b) Combine the above results to prove that the polynomial P is admissible for index m , and conclude that $P(x)$ is a polynomial of degree $2m + 1$ that is usable as the polynomial in the definition of the Meyer wavelet of index m .

Problems 18–19 refer to the spaces $H^s(\mathbb{R})$ of Bessel potentials studied in Problems 8–12 for Chapter III. The idea is to show that the Daubechies wavelet of order N lies in

a suitable space $H^s(\mathbb{R})$ with s equal to a real number depending on N . Then one can conclude that the Daubechies scaling function and wavelet of order N automatically have whatever smoothness is forced on all functions in the space $H^s(\mathbb{R})$.

18. Using the estimate

$$|(\mathcal{F}\varphi)(y)|^2 \leq \left(\frac{2^{N-1}}{\sqrt{\pi N}}\right)(\sqrt{4\pi N})^{-j} \quad \text{for } 2^{j-1} \leq |y| \leq 2^j$$

from Proposition 10.43, show that the Daubechies scaling function φ and wavelet ψ of order N lie in $H^s(\mathbb{R})$ if $s < \frac{1}{4} \log_2(\pi N)$.

19. Deduce Corollary 10.46 from the previous problem in combination with Problem 12c for Chapter III, showing that if m is an integer ≥ 0 with $m < \frac{1}{4} \log_2(\pi N/4)$, then the Daubechies scaling function φ and wavelet ψ of order N are of class C^m .

HINTS FOR SOLUTIONS OF PROBLEMS

Chapter I

1. We start from

$$\int_0^l \sin p_n x \sin p_m x \, dx = -\frac{1}{2} \int_0^l \cos(p_n + p_m)x \, dx + \frac{1}{2} \int_0^l \cos(p_n - p_m)x \, dx.$$

The first term on the right is equal to

$$\begin{aligned} -\frac{1}{2} \frac{1}{p_n + p_m} \sin(p_n + p_m)l &= -\frac{1}{2} \frac{1}{p_n + p_m} (\sin p_n l \cos p_m l + \cos p_n l \sin p_m l) \\ &= -\frac{1}{2} \frac{1}{p_n + p_m} \left(-\frac{p_n}{h} \cos p_n l \cos p_m l - \frac{p_m}{h} \cos p_n l \cos p_m l \right) \\ &= \frac{1}{2h} \frac{1}{p_n + p_m} (p_n + p_m) \cos p_n l \cos p_m l = \frac{1}{2h} \cos p_n l \cos p_m l. \end{aligned}$$

Similarly the second term on the right is $-\frac{1}{2h} \cos p_n l \cos p_m l$. The two terms cancel, and the desired orthogonality follows.

2. In (a), the adjusted operator is $L(u) = ((1 - t^2)u)'$, and Green's formula gives

$$\begin{aligned} (\lambda_n - \lambda_m) \int_{-1}^1 P_n(t) P_m(t) \, dt &= (L(P_n), P_m) - (P_n, L(P_m)) \\ &= [(1 - t^2)(P_n'(t) P_m(t) - P_n(t) P_m'(t))]_{-1}^1, \end{aligned}$$

where λ_n and λ_m are the values $\lambda_n = -n(n + 1)$ and $\lambda_m = -m(m + 1)$ such that $L(P_n) = \lambda_n P_n$ and $L(P_m) = \lambda_m P_m$. The right side is 0 because $1 - t^2$ vanishes at -1 and 1 .

In (b), the adjusted operator is $L(u) = (tu)' + tu$, and $L(J_0(k \cdot))$ equals $-k^2 t$ if $J_0(k) = 0$. Green's formula gives

$$\begin{aligned} (-k_n^2 + k_m^2) \int_0^1 J_0(k_n t) J_0(k_m t) t \, dt &= (L(J_0(k_n \cdot)), J_0(k_m \cdot)) - (J_0(k_n \cdot), L(J_0(k_m \cdot))) \\ &= \left[t \left(\frac{d}{dt} (J_0(k_n \cdot))(t) J_0(k_m t) - J_0(k_n t) \frac{d}{dt} (J_0(k_m \cdot))(t) \right) \right]_0^1. \end{aligned}$$

The expression in brackets on the right side is 0 at $t = 1$ because $J_0(k_n) = J_0(k_m) = 0$, and it is 0 at $t = 0$ because of the factor t .

3. With $L(u) = (p(t)u')' - q(t)u$, the formula for $u^*(t) = \int_a^t G_0(t, s)f(s) ds$ in the proof of Lemma 4.4 is

$$u^*(t) = p(c)^{-1} \left(-\varphi_1(t) \int_a^t \varphi_2(s)f(s) ds + \varphi_2(t) \int_a^t \varphi_1(s)f(s) ds \right).$$

As is observed in the proof of Lemma 4.4, the derivative of this involves terms in which the integrals are differentiated at their upper limits, and these terms drop out. Thus

$$u^{*'}(t) = p(c)^{-1} \left(-\varphi_1'(t) \int_a^t \varphi_2(s)f(s) ds + \varphi_2'(t) \int_a^t \varphi_1(s)f(s) ds \right).$$

For the second derivative, the terms do not drop out, and we obtain

$$\begin{aligned} u^{*''}(t) &= p(c)^{-1} \left(-\varphi_1''(t) \int_a^t \varphi_2(s)f(s) ds + \varphi_2''(t) \int_a^t \varphi_1(s)f(s) ds \right) \\ &\quad + p(c)^{-1} \left(-\varphi_1'(t)\varphi_2(t)f(t) + \varphi_2'(t)\varphi_1(t)f(t) \right). \end{aligned}$$

When we combine these expressions to form $p(t)u^{*''}(t) + p'(t)u^{*'}(t) - q(t)u^*(t)$, the coefficient of $\int_a^t \varphi_2(s)f(s) ds$ is $-p(c)^{-1}L(\varphi_1) = 0$, and similarly the coefficient of $\int_a^t \varphi_1(s)f(s) ds$ is $p(c)^{-1}L(\varphi_2) = 0$. Thus

$$\begin{aligned} L(u^*) &= p(c)^{-1}p(t)f(t) \left(-\varphi_1'(t)\varphi_2(t) + \varphi_2'(t)\varphi_1(t) \right) \\ &= p(c)^{-1}p(t)f(t) \det W(\varphi_1, \varphi_2)(t) = f(t), \end{aligned}$$

the value of $\det W(\varphi_1, \varphi_2)$ having been computed in the proof. This completes (a).

For (b), we can take $\varphi_1(t) = \cos t$ and $\varphi_2(t) = \sin t$. Since $p(t) = 1$, we obtain

$$G_0(t, s) = \begin{cases} \sin t \cos s - \cos t \sin s & \text{if } s \leq t, \\ 0 & \text{if } s > t. \end{cases}$$

The conditions $u(0) = 0$ and $u(\pi/2) = 0$ mean that $a = 0$, $b = \pi/2$, $c_1 = d_1 = 1$, and $c_2 = d_2 = 0$ in (SL2). Thus the system of equations (*) in the proof of Lemma 4.4 reads

$$\begin{pmatrix} \cos 0 & \sin 0 \\ \cos \frac{\pi}{2} & \sin \frac{\pi}{2} \end{pmatrix} \begin{pmatrix} k_1 \\ k_2 \end{pmatrix} = \begin{pmatrix} -u^*(0) \\ -u^*(\pi/2) \end{pmatrix},$$

and we obtain $k_1 = -u^*(0) = 0$ and $k_2 = -u^*(\pi/2) = -\int_0^{\pi/2} f(s) \cos s ds$. The proof of Lemma 4.4 says to take $K_1(s) = 0$ and $K_2(s) = -\cos s$. The formula for $G_1(t, s)$ is $G_1(t, s) = G_0(t, s) + K_1(s)\varphi_1(t) + K_2(s)\varphi_2(t)$, and therefore

$$G_1(t, s) = \begin{cases} \sin t \cos s - \cos t \sin s \\ 0 \end{cases} - \sin t \cos s = \begin{cases} -\cos t \sin s \\ -\sin t \cos s \end{cases}.$$

In particular, $G_1(t, s)$ is symmetric, as it is supposed to be!

4. We have $\int_{t_1}^{t_2} ((py_1')'y_2 - (py_2')'y_1) dt = \int_{t_1}^{t_2} (g_2 - g_1)y_1y_2 dt > 0$ as a result of the outlined steps. Since $((py_1')'y_2 - (py_2')'y_1) = \frac{d}{dt}(p(y_1'y_2 - y_1y_2'))$, we conclude that $[p(y_1'y_2 - y_1y_2')]_{t_1}^{t_2} > 0$. This proves (a).

Since $y_1(t_1) = y_1(t_2) = 0$, the expression $p(t)y_1'(t)y_2(t) - p(t)y_1(t)y_2'(t)$ is $p(t_2)y_1'(t_2)y_2(t_2)$ at $t = t_2$. Here $p(t_2) > 0$ and $y_2(t_2) \geq 0$. Since $y_1(t_2) = 0$ and since $y_1(t) > 0$ for all t slightly less than t_2 , we obtain $y_1'(t_2) \leq 0$. Thus $p(t_2)y_1'(t_2)y_2(t_2) \leq 0$. Similarly the same expression is $p(t_1)y_1'(t_1)y_2(t_1)$ at $t = t_1$. We have $p(t_1) > 0$ and $y_2(t_1) \geq 0$. Since $y_1(t_1) = 0$ and $y_1(t) > 0$ for t slightly greater than t_1 , we obtain $y_1'(t_1) \geq 0$. Thus $p(t_1)y_1'(t_1)y_2(t_1) \geq 0$. This gives the desired contradiction and completes (b).

Part (c) is just the special case in which $g_1(t) = -q(t) + \lambda_1 r(t)$ and $g_2(t) = -q(t) + \lambda_2 r(t)$. The hypothesis on $g_2 - g_1$ is satisfied because $g_2(t) - g_1(t) = (\lambda_2 - \lambda_1)r(t) > 0$.

5. For (a), substitute for $\Psi(x, t)$ and get $-\psi''(x)\varphi(t) + V(x)\psi(x)\varphi(t) = i\psi(x)\varphi'(t)$. Divide by $\psi(x)\varphi(t)$ to obtain $-\frac{\psi''(x)}{\psi(x)} + V(x) = i\frac{\varphi'(t)}{\varphi(t)}$. The left side depends only on x , and the right side depends only on t . So the two sides must be some constant E . Then $-\frac{\psi''(x)}{\psi(x)} + V(x) = E$ yields $\psi'' + (E - V(x))\psi = 0$.

For (b), the equation for φ is $i\frac{\varphi'(t)}{\varphi(t)} = E$. Then $\varphi' = -iE\varphi$, and $\varphi(t) = ce^{-iEt}$.

6. We substitute $\psi(x) = e^{-x^2/2}H(x)$, $\psi'(x) = -xe^{-x^2/2}H(x) + e^{-x^2/2}H'(x)$, and $\psi''(x) = x^2e^{-x^2/2}H(x) - 2xe^{-x^2/2}H'(x) + e^{-x^2/2}H''(x) - e^{-x^2/2}H(x)$, and we are led to Hermite's equation.

7. Write $H(x) = \sum_{k=0}^{\infty} c_k x^k$. We find that c_0 and c_1 are arbitrary and that $(k+2)(k+1)c_{k+2} - (2n-2k)c_k = 0$ for $k \geq 0$. To get a polynomial of degree d , we must have $c_d \neq 0$ and $c_{d+2} = 0$. Since $c_{d+2} = c_d(2n-2d)/((d+2)(d+1))$, this happens if and only if $d = n$.

8. We have $L(H_n(x)e^{-x^2/2}) = -(2n+1)H_n(x)e^{-x^2/2}$. Define an inner product by integrating over $[-N, N]$. Then

$$\begin{aligned} & -2(n-m) \int_{-N}^N H_n(x)H_m(x)e^{-x^2} dx \\ & = (L(H_n(x)e^{-x^2/2}), H_m(x)e^{-x^2/2}) - (H_n(x)e^{-x^2/2}, L(H_m(x)e^{-x^2/2})) \\ & = [(H_n(x)e^{-x^2/2})'(H_m(x)e^{-x^2/2}) - (H_n(x)e^{-x^2/2})(H_m(x)e^{-x^2/2})']_{-N}^N. \end{aligned}$$

As N tends to infinity, the right side tends to 0. Since $n \neq m$, we obtain the desired orthogonality.

Chapter II

1. A condition in (a) is that f take on some value on a set of positive measure. A condition in (b) is that f take on only countably many values, these tending to 0,

and that the set E where f is nonzero be the countable union of sets E_n of positive measure such that no E_n decomposes as the disjoint union of two sets of positive measure.

2. Let v_n be in $\text{image}(\lambda I - L)$ with $v_n \rightarrow v$, and choose u_n with $(\lambda I - L)u_n = v_n$. We are to show that v is in the image. We may assume that $v \neq 0$, so that $\|v_n\|$ is bounded below by a positive constant for large n . Since $\|v_n\| \leq \|\lambda I - L\| \|u_n\|$, $\|u_n\|$ is bounded below for large n . Passing to a subsequence, we may assume either that $\|u_n\|$ tends to infinity or that $\|u_n\|$ is bounded.

If $\|u_n\|$ is bounded, then we may assume by passing to a subsequence that $\{Lu_n\}$ is convergent, say with limit w . From $\lambda u_n = Lu_n + v_n$, we see that $\lambda u_n \rightarrow w + v$. Put $u = \lambda^{-1}(w + v)$. Then $(\lambda I - L)u = (w + v) - \lim Lu_n = w + v - w = v$, and v is in the image.

If $\|u_n\|$ tends to infinity, choose a subsequence such that $\{L(\|u_n\|^{-1}u_n)\}$ is convergent, say to w . Then we have $\|u_n\|^{-1}\lambda u_n - L(\|u_n\|^{-1}u_n) = \|u_n\|^{-1}v_n$. Passing to the limit and using that $v_n \rightarrow v$, we see that $\|u_n\|^{-1}\lambda u_n \rightarrow w$. Applying L , we obtain $\lambda w = L(w)$. Thus $(\lambda I - L)w = 0$. Since $\lambda I - L$ is one-one, $w = 0$. Then $\|u_n\|^{-1}\lambda u_n \rightarrow 0$, and we obtain a contradiction since $\|u_n\|^{-1}\lambda u_n$ has norm $|\lambda|$ for all n .

3. It was shown in Section 4 that the set of Hilbert–Schmidt operators is a normed linear space with norm $\|\cdot\|_{\text{HS}}$. Since $\|L\| \leq \|L\|_{\text{HS}}$, any Cauchy sequence $\{L_n\}$ in this space is Cauchy in the operator norm. The completeness of the space of bounded linear operators in the operator norm shows that $\{L_n\}$ converges to some L in the operator norm. In particular, $\lim_n(L_n u, v) = (Lu, v)$ for all u and v . By Fatou’s Lemma,

$$\begin{aligned} \|L\|_{\text{HS}}^2 &= \sum_j \|Lu_j\|^2 = \sum_j \liminf_n \|L_n u_j\|^2 \\ &\leq \liminf_n \sum_j \|L_n u_j\|^2 = \liminf_n \|L_n\|_{\text{HS}}^2. \end{aligned}$$

The right side is finite since Cauchy sequences are bounded, and hence L is a Hilbert–Schmidt operator. A second application of Fatou’s Lemma gives

$$\begin{aligned} \|L_m - L\|_{\text{HS}}^2 &= \sum_j \|(L_m - L)u_j\|^2 = \sum_j \liminf_n \|(L_m - L_n)u_j\|^2 \\ &\leq \liminf_n \sum_j \|(L_m - L_n)u_j\|^2 = \liminf_n \|L_m - L_n\|_{\text{HS}}^2. \end{aligned}$$

Since the given sequence is Cauchy, the \limsup on m of the right side is 0, and hence $\{L_m\}$ converges to L in the Hilbert–Schmidt norm.

4. If L and M are of trace class, then $\sum_i |(L + M)u_i, v_i| \leq \sum_i (|(Lu_i, v_i)| + |(Mu_i, v_i)|) \leq \|L\|_{\text{TC}} + \|M\|_{\text{TC}}$. Taking the supremum over all orthonormal bases $\{u_i\}$ and $\{v_i\}$, we obtain the triangle inequality.

5. Once we know that $\text{Tr}(AL) = \text{Tr}(LA)$, then $\text{Tr}(BLB^{-1}) = \text{Tr}(B^{-1}(BL)) = \text{Tr}(L)$. To prove that $\text{Tr}(AL) = \text{Tr}(LA)$, fix an orthonormal basis $\{u_i\}$. The formal

computation is

$$\begin{aligned}\operatorname{Tr}(AL) &= \sum_j (ALu_j, u_j) = \sum_j (Lu_j, A^*u_j) = \sum_j \sum_i (Lu_j, u_i) \overline{(A^*u_j, u_i)} \\ &= \sum_j \sum_i (Au_i, u_j) \overline{(L^*u_i, u_j)} = \sum_i \sum_j (Au_i, u_j) \overline{(L^*u_i, u_j)} \\ &= \sum_i (Au_i, L^*u_i) = \sum_i (LAu_i, u_i) = \operatorname{Tr}(LA),\end{aligned}$$

and justification is needed for the interchange of order of summation within the second line. It is enough to have absolute convergence in *some* orthonormal basis, and this will be derived from the estimate

$$\begin{aligned}\sum_{i,j} |(Au_i, u_j)(L^*u_i, u_j)| &\leq \sum_i \left(\sum_j |(Au_i, u_j)|^2 \right)^{1/2} \left(\sum_j |(L^*u_i, u_j)|^2 \right)^{1/2} \\ &= \sum_i \|Au_i\| \|L^*u_i\| \leq \|A\| \sum_i \|L^*u_i\|.\end{aligned}$$

The proof of Proposition 2.8, applied to L^* instead of L , produces operators U and T , orthonormal bases $\{w_i\}$ and $\{f_i\}$, and scalars $\lambda_i \geq 0$ such that $L^* = UT$, $\|U\| \leq 1$, $Tw_i = \sqrt{\lambda_i}w_i$, and $\sum |(L^*w_i, f_i)| = \sum (Tw_i, w_i)$. Taking $u_i = w_i$, we have $\|L^*w_i\| = \|UTw_i\| \leq \|Tw_i\| = \sqrt{\lambda_i} = (Tw_i, w_i)$. Hence for this orthonormal basis, $\sum \|L^*w_i\| \leq \sum (Tw_i, w_i) = \sum |(L^*w_i, f_i)|$. The right side is finite since L^* is of trace class.

6. If v is a nonzero vector in the λ eigenspace of L_α and if $L_\beta L_\alpha = L_\alpha L_\beta$, then $L_\alpha L_\beta(v) = L_\beta L_\alpha(v) = \lambda L_\beta v$. Thus the λ eigenspace of L_α is invariant under L_β . We apply Theorem 2.3 to the compact operator L_β on each eigenspace of L_α , obtaining an orthonormal basis of simultaneous eigenvectors under L_α and L_β . Iterating this procedure by taking into account one new operator at a time, we obtain the desired basis.

7. In (a), the operators $L + L^*$ and $-i(L - L^*)$ are self adjoint, and they commute since L commutes with L^* . Compactness is preserved under passage to adjoints and under taking linear combinations, and (b) follows.

8. If U is unitary, then $U^* = U^{-1}$. Then $UU^{-1} = I = U^{-1}U$ shows that U is normal. Since U preserves norms, every eigenvalue λ has $|\lambda| = 1$. If U is also compact, then the eigenvalues tend to 0. Hence U is compact if and only if the Hilbert space is finite-dimensional.

9. The solutions of the homogeneous equation are spanned by $\cos \omega t$ and $\sin \omega t$. Then the result follows by applying variation of parameters.

10. Take $g(s) = \rho(s)u(s)$ in Problem 9.

11. In (a), let $t < t'$. Then

$$\begin{aligned}(Tf)(t') - (Tf)(t) &= \int_s^{t'} K(t', s)f(s) ds - \int_a^t K(t, s)f(s) ds \\ &= \int_t^{t'} K(t', s)f(s) ds + \int_a^t [K(t', s) - K(t, s)]f(s) ds.\end{aligned}$$

The first term on the right tends to 0 as $t' - t$ tends to 0 because the integrand is bounded, and the second term tends to 0 by the boundedness of f and the uniform continuity of $K(t', s) - K(t, s)$ on the set of (s, t, t') where $a \leq s \leq t \leq t'$.

In (b), for $n = 1$, we have $|(Tf)(t)| = \left| \int_a^t K(t, s)f(s) ds \right| \leq M \int_a^t |f(s)| ds \leq CM$ as required. Assume the result for $n - 1 \geq 1$, namely that $|(T^{n-1}f)(t)| \leq \frac{1}{(n-2)!} CM^{n-1}(t-a)^{n-2}$. Then $|(T^n f)(t)| = \left| \int_a^t K(t, s)(T^{n-1}f)(s) ds \right| \leq M \int_a^t |(T^{n-1}f)(s)| ds \leq M \frac{1}{(n-2)!} CM^{n-1} \int_a^t (s-a)^{n-2} ds = \frac{1}{(n-1)!} CM^n (t-a)^{n-1}$. Thus the n^{th} term of the series is $\leq \frac{1}{(n-1)!} CM^n (b-a)^{n-1}$.

In (c), the uniform convergence follows from the estimate in (b) and the Weierstrass M test.

12. The operator T is bounded as a linear operator from $C([a, b])$ into itself. Because of the uniform convergence, we can apply the operator term by term to the series defining u . The result is $Tu = Tf + T^2f + T^3f + \cdots = u - f$. Therefore $u - Tu = f$.

13. Subtracting, we are to investigate solutions of $u - Tu = 0$. Problem 11 showed for each continuous u that the series $u + Tu + T^2u + \cdots$ is uniformly convergent. If $u = Tu$, then all the terms in this series equal u , and the only way that the series can converge uniformly is if $u = 0$.

Chapter III

1. Let $D_j = \partial/\partial y_j$. Let $\tilde{\mathcal{S}}$ be the vector space of all linear combinations of functions $(1 + 4\pi^2|y|^2)^{-n}h$ with n a positive integer and h in the Schwartz space \mathcal{S} . Then $D_j((1 + 4\pi^2|y|^2)^{-n}h) = -8n\pi^2 y_j(1 + 4\pi^2|y|^2)^{-(n+1)}h + (1 + 4\pi^2|y|^2)^{-n}D_jh$. The first term on the right side is in $\tilde{\mathcal{S}}$ because y_jh is in \mathcal{S} , and the second term on the right side is in $\tilde{\mathcal{S}}$ because D_jh is in \mathcal{S} . Thus $\tilde{\mathcal{S}}$ is closed under all partial derivatives. Since the product of a polynomial and a Schwartz function is a Schwartz function, $\tilde{\mathcal{S}}$ is closed under multiplication by polynomials. Since the members of $\tilde{\mathcal{S}}$ are bounded, we must have $\tilde{\mathcal{S}} \subseteq \mathcal{S}$. In particular, $(1 + 4\pi^2|y|^2)^{-1}g$ is in \mathcal{S} if g is in \mathcal{S} .

2. Since the Fourier transform and its inverse are continuous, it is enough to handle pointwise product. Pointwise product is handled directly.

3. In (a), the ordinary partial derivatives are $D_x(\log((x^2 + y^2)^{-1})) = \frac{-2x}{x^2 + y^2}$ and $D_y(\log((x^2 + y^2)^{-1})) = \frac{-2y}{x^2 + y^2}$. These are also weak derivatives. In fact, use of polar coordinates shows that they are integrable near $(0, 0)$, hence locally integrable on \mathbb{R}^2 . If φ is in $C_{\text{com}}^\infty(\Omega)$, we are to show that $\int_\Omega \log((x^2 + y^2)^{-1})D_x\varphi(x, y) dx dy = \int_\Omega \frac{2x\varphi(x, y)}{x^2 + y^2} dx dy$ and similarly for y . For each $y \neq 0$, the integrals over x are equal, and the set where $y = 0$ is of measure 0 in Ω . The argument with the variables interchanged is similar. Thus $\log((x^2 + y^2)^{-1})$ has weak derivatives of order 1. In

polar coordinates the p^{th} power of $\left|\frac{x\varphi(x,y)}{x^2+y^2}\right|$ is $\frac{r^p|\cos\theta|^p}{r^{2p}} = r^{-p}|\cos\theta|^p$, which is integrable near $r = 0$ relative to $r dr$ for $p < 2$ but not $p = 2$.

In (b), the argument for the existence of the weak derivative of $\log \log((x^2 + y^2)^{-1})$ is similar to the argument for (a), the ordinary x derivative being

$$\frac{-2x}{(x^2 + y^2) \log((x^2 + y^2)^{-1})}.$$

In polar coordinates the square of this is $\frac{4 \cos^2 \theta}{r^2 \log^2(r^{-2})}$, which is integrable relative to $r dr$.

4. The idea is to use the Implicit Function Theorem to obtain, for each point of the boundary, a neighborhood of the point for which some coordinate has the property that the cone of a particular size and orientation based at any point in that neighborhood lies in the region. These neighborhoods cover the boundary, and we extract a finite subcover. Then we obtain a single size of cone such that every point of the boundary has some coordinate where the cone lies in Ω . The cones based at the boundary points cover all points within some distance $\epsilon > 0$ of the boundary, and cones of half the height based at interior points within those cones and within distance $\epsilon/2$ of the boundary lie within the cones for the boundary points. The remaining points of the region can then be covered by a cone with any orientation such that its vertex is at distance $< \epsilon/2$ from all its other points.

5. For $0 < \alpha < N$, $|x|^{-(N-\alpha)}$ is the sum of an L^1 function and an L^∞ function and hence is a tempered distribution. It is the sum of an L^1 function and an L^2 function for $0 < \alpha < N/2$.

6. The second expression is converted into the first by changing t into $1/t$. The first expression is evaluated as the third by replacing $t|x|^2$ by s .

7. The formula obtained from the first displayed identity is

$$\int_{\mathbb{R}^N} (\pi|x|^2)^{-\frac{1}{2}(N-\alpha)} \Gamma(\frac{1}{2}(N-\alpha)) \widehat{\varphi}(x) dx = \int_{\mathbb{R}^N} (\pi|x|^2)^{-\frac{1}{2}\alpha} \Gamma(\frac{1}{2}\alpha) \varphi(x) dx,$$

which sorts out as

$$\pi^{-\frac{1}{2}(N-\alpha)} \Gamma(\frac{1}{2}(N-\alpha)) \int_{\mathbb{R}^N} |x|^{-(N-\alpha)} \widehat{\varphi}(x) dx = \pi^{-\frac{1}{2}\alpha} \Gamma(\frac{1}{2}\alpha) \int_{\mathbb{R}^N} |x|^{-\alpha} \varphi(x) dx.$$

8. In (a), we check directly that $\mathcal{F}(D^\alpha T) = (2\pi i)^{|\alpha|} \xi^\alpha \mathcal{F}(T)$. Since T is in H^s , $\int_{\mathbb{R}^N} |\mathcal{F}(T)(\xi)|^2 (1 + |\xi|^2)^s d\xi$ is finite. Now $|\xi_j| \leq |\xi| \leq (1 + |\xi|^2)^{1/2}$ for every j , and hence $|\xi^\alpha| \leq (1 + |\xi|^2)^{s/2}$ for $|\alpha| = s$. Since $(1 + |\xi|^2)^{1/2} \geq 1$, $(1 + |\xi|^2)^{t/2}$ is an increasing function of t , and thus $|\xi^\alpha| \leq (1 + |\xi|^2)^{s/2}$ for $|\alpha| \leq s$. Consequently $(2\pi i)^{|\alpha|} \xi^\alpha \mathcal{F}(T)$ is square integrable for $|\alpha| \leq s$. Thus the Fourier transform of $D^\alpha T$ is a square integrable function for $|\alpha| \leq s$. By the Plancherel formula, $D^\alpha T$ is a square integrable function for $|\alpha| \leq s$.

Let T be the L^2 function f , and let $D^\alpha T$ be the L^2 function g_α for $|\alpha| \leq s$. The statement that f has g_α as weak derivative of order α is the statement that $\int_{\mathbb{R}^N} f D^\alpha \varphi dx = (-1)^{|\alpha|} \int_{\mathbb{R}^N} g_\alpha \varphi dx$ for $\varphi \in C_{\text{com}}^\infty(\mathbb{R}^N)$; this is proved for $\psi = \bar{\varphi}$ by the following computation, which uses the polarized version of the Plancherel formula twice:

$$\begin{aligned} (-1)^{|\alpha|} \int_{\mathbb{R}^N} g_\alpha \bar{\psi} dx &= (-1)^{|\alpha|} \int_{\mathbb{R}^N} (2\pi i)^{|\alpha|} \xi^\alpha \mathcal{F}(f) \overline{\mathcal{F}(\psi)} d\xi \\ &= \int_{\mathbb{R}^N} \mathcal{F}(f) \overline{(2\pi i)^{|\alpha|} \xi^\alpha \mathcal{F}(\psi)} d\xi = \int_{\mathbb{R}^N} \mathcal{F}(f) \overline{\mathcal{F}(D^\alpha \psi)} d\xi = \int_{\mathbb{R}^N} f \overline{D^\alpha \psi} dx. \end{aligned}$$

Since f and its weak derivatives g_α through $|\alpha| \leq s$ are all in L^2 , f is in $L^2_s(\mathbb{R}^N)$.

In (b), if T is given by an L^2 function, then $\mathcal{F}(T) = \mathcal{F}(f)$ is an L^2 function. Hence $\mathcal{F}(T)$ is locally square integrable. We are assuming that $D^\alpha T$ is given by an L^2 function g_α for $|\alpha| \leq s$. The formula $\mathcal{F}(g_\alpha) = \mathcal{F}(D^\alpha T) = (2\pi i)^{|\alpha|} \xi^\alpha \mathcal{F}(T)$ shows that $\xi^\alpha \mathcal{F}(f)$ is in L^2 for $|\alpha| \leq s$. Now $|\xi|^2 |\mathcal{F}(f)|^2 = \sum_j |\xi_j \mathcal{F}(f)|^2$ and similarly $|\xi|^{2k} |\mathcal{F}(f)|^2 = \sum_{j_1, \dots, j_k} |\xi_{j_1} \cdots \xi_{j_k} \mathcal{F}(f)|^2 = \sum_{|\alpha|=k} \binom{|\alpha|}{\alpha_1, \dots, \alpha_N} |\xi^\alpha \mathcal{F}(f)|^2$. Hence

$$(1 + |\xi|^2)^s |\mathcal{F}(f)|^2 = \sum_{k=0}^s \binom{s}{k} \sum_{|\alpha|=k} \binom{|\alpha|}{\alpha_1, \dots, \alpha_N} |\xi^\alpha \mathcal{F}(f)|^2 \leq s! \sum_{|\alpha| \leq s} |\xi^\alpha \mathcal{F}(f)|^2,$$

and f is in H^s .

For (c), in one direction the argument for (a) gives

$$\begin{aligned} \|f\|_{L^2_s}^2 &= \sum_{|\alpha| \leq s} \|D^\alpha f\|_{L^2}^2 = \sum_{|\alpha| \leq s} \|(2\pi i)^{|\alpha|} \xi^\alpha \mathcal{F}(f)\|_{L^2}^2 \\ &\leq \left(\sum_{|\alpha| \leq s} (2\pi)^{2|\alpha|} \right) \|(1 + |\xi|^2)^{s/2} \mathcal{F}(f)\|_{L^2}^2 \leq \left(\sum_{|\alpha| \leq s} (2\pi)^{2|\alpha|} \right) \|f\|_{H^s}^2. \end{aligned}$$

In the other direction the displayed formula for (b), when integrated, gives

$$\|f\|_{H^s}^2 \leq s! \sum_{|\alpha| \leq s} |2\pi i|^{-|\alpha|} \|D^\alpha f\|_{L^2}^2 \leq s! \|f\|_{L^2_s}^2.$$

9. In (a), let T be in H^s . Then the computation

$$\|T\|_{H^s}^2 = \|(1 + |\xi|^2)^{s/2} \mathcal{F}(T)\|_{L^2}^2 = \|\mathcal{F}^{-1}((1 + |\xi|^2)^{s/2} \mathcal{F}(T))\|_{L^2}^2 = \|A_s(T)\|_{L^2}^2$$

shows that A_s preserves norms. To see that A_s is onto L^2 , let f be in L^2 . Then $\mathcal{F}(f)$ is in L^2 and hence acts as a tempered distribution. Then $(1 + |\xi|^2)^{-s/2} \mathcal{F}(f)$ is a tempered distribution also. Since \mathcal{F} carries $\mathcal{S}'(\mathbb{R}^N)$ onto itself, $T = \mathcal{F}^{-1}((1 + |\xi|^2)^{-s/2} \mathcal{F}(f))$ is a tempered distribution. This tempered distribution has the property that $A_s(T) = f$.

In (b), the relevant formula is that $(A_s)^{-1}(\varphi) = \mathcal{F}^{-1}((1 + |\xi|^2)^{-s/2} \mathcal{F}(\varphi))$. If φ is in $\mathcal{S}(\mathbb{R}^N)$, then so is $\mathcal{F}(\varphi)$. An easy induction shows that any iterated derivative of $(1 + |\xi|^2)^{-s/2}$ is a sum of products of polynomials in ξ times powers (possibly negative) of $1 + |\xi|^2$. Application of the Leibniz rule therefore shows that any iterated derivative

of $(1 + |\xi|^2)^{-s/2}\mathcal{F}(\varphi)$ is a sum of products of polynomials in ξ times derivatives of $\mathcal{F}(\varphi)$, all divided by powers of $1 + |\xi|^2$. Consequently $(1 + |\xi|^2)^{-s/2}\mathcal{F}(\varphi)$ is a Schwartz function, and so is its inverse Fourier transform.

For (c), we know that $C_{\text{com}}^\infty(\mathbb{R}^N)$ is dense in $L^2(\mathbb{R}^N)$, and hence $\mathcal{S}(\mathbb{R}^N)$ is dense in $L^2(\mathbb{R}^N)$ also. Applying the operator $(A_s)^{-1}$, which must carry $\mathcal{S}(\mathbb{R}^N)$ onto itself, we see that $\mathcal{S}(\mathbb{R}^N)$ is dense in H^s .

10. If T is in H^{-s} and φ is in $\mathcal{S}(\mathbb{R}^N)$, then the definition of Fourier transform on $\mathcal{S}(\mathbb{R}^N)$, together with the Schwarz inequality, implies that

$$\begin{aligned} |\langle T, \varphi \rangle| &= |\langle \mathcal{F}(T), \mathcal{F}^{-1}(\varphi) \rangle| = \left| \int_{\mathbb{R}^N} \mathcal{F}(T)(\xi) \mathcal{F}^{-1}(\varphi)(\xi) d\xi \right| \\ &= \left| \int_{\mathbb{R}^N} [(1 + |\xi|^2)^{-s/2} \mathcal{F}(T)(\xi)] [(1 + |\xi|^2)^{s/2} \mathcal{F}^{-1}(\varphi)(\xi)] d\xi \right| \\ &\leq \|(1 + |\xi|^2)^{-s/2} \mathcal{F}(T)\|_{L^2} \|(1 + |\xi|^2)^{s/2} \mathcal{F}^{-1}(\varphi)\|_{L^2} = \|T\|_{H^{-s}} \|\varphi\|_{H^s}. \end{aligned}$$

11. For ψ in $\mathcal{S}(\mathbb{R}^N)$, we have $|\langle \mathcal{F}(T), \psi \rangle| = |\langle T, \mathcal{F}(\psi) \rangle| \leq C \|\mathcal{F}(\psi)\|_{H^s} = C \left(\int_{\mathbb{R}^N} |\mathcal{F}(\mathcal{F}(\psi))(\xi)|^2 (1 + |\xi|^2)^s d\xi \right)^{1/2} = C \left(\int_{\mathbb{R}^N} |\psi(-\xi)|^2 (1 + |\xi|^2)^s d\xi \right)^{1/2} = C \|\psi\|_{L^2(\mathbb{R}^N, (1+|\xi|^2)^s d\xi)}$. Thus $\mathcal{F}(T)$ acts as a bounded linear functional on the dense vector subspace $\mathcal{S}(\mathbb{R}^N)$ of $L^2(\mathbb{R}^N, (1 + |\xi|^2)^s d\xi)$. Extending this linear functional continuously to the whole space and applying the Riesz Representation Theorem for Hilbert spaces, we obtain a function f in $L^2(\mathbb{R}^N, (1 + |\xi|^2)^s d\xi)$ such that

$$\langle \mathcal{F}(T), \psi \rangle = \int_{\mathbb{R}^N} \psi(\xi) \overline{f(\xi)} (1 + |\xi|^2)^s d\xi$$

for all ψ in $\mathcal{S}(\mathbb{R}^N)$. Put $\psi_0(\xi) = \overline{f(\xi)}(1 + |\xi|^2)^s$. Then $\int_{\mathbb{R}^N} |\psi_0(\xi)|^2 (1 + |\xi|^2)^{-s} d\xi = \int_{\mathbb{R}^N} |f(\xi)|^2 (1 + |\xi|^2)^s d\xi < \infty$, and the above displayed formula shows that $\mathcal{F}(T)$ agrees with the function ψ_0 on $\mathcal{S}(\mathbb{R}^N)$. Thus T is in H^{-s} . To estimate $\|T\|_{H^{-s}}$, we twice use the fact that $\mathcal{S}(\mathbb{R}^N)$ is dense: $\|T\|_{H^{-s}} = \|\psi_0\|_{L^2(\mathbb{R}^N, (1+|\xi|^2)^{-s} d\xi)} = \|f\|_{L^2(\mathbb{R}^N, (1+|\xi|^2)^s d\xi)} = \sup_{\|\psi\|_{L^2(\mathbb{R}^N, (1+|\xi|^2)^s d\xi)} \leq 1} |\langle \mathcal{F}(T), \psi \rangle| = \sup_{\|\varphi\|_{H^s} \leq 1} |\langle T, \varphi \rangle|$. Thus $\|T\|_{H^{-s}} \leq C$.

12. In (a), we apply the Schwarz inequality: $\|\varphi\|_{\text{sup}} \leq \|\mathcal{F}^{-1}(\varphi)\|_1 = \|\mathcal{F}(\varphi)\|_1 = \int_{\mathbb{R}^N} |\mathcal{F}(\varphi)(\xi)| (1 + |\xi|^2)^{s/2} [(1 + |\xi|^2)^{-s/2}] d\xi \leq \|T_\varphi\|_{H^s} \left(\int_{\mathbb{R}^N} |1 + |\xi|^2|^{-s} d\xi \right)^{1/2}$.

For (b), the last integral in (a) is finite for $s > N/2$. Thus we have $\|\varphi\|_{\text{sup}} \leq C \|T_\varphi\|_{H^s}$ for all φ in $\mathcal{S}(\mathbb{R}^N)$. If T is in H^s , we know from Problem 9c that we can find a sequence φ_k in $\mathcal{S}(\mathbb{R}^N)$ such that T_{φ_k} tends to T in H^s . For $p \leq q$, we then have $\|\varphi_p - \varphi_q\|_{\text{sup}} \leq C \|T_{\varphi_p} - T_{\varphi_q}\|_{H^s}$. Letting q tend to infinity, we see that φ_p converges uniformly to some function f , necessarily continuous and bounded. Let T_f be the tempered distribution given by f . We show that $T = T_f$. If ψ is in $\mathcal{S}(\mathbb{R}^N)$, then $\mathcal{F}(\psi)$ is integrable, being a Schwartz function, and the uniform convergence of φ_p to f implies that $\langle T_f, \mathcal{F}(\psi) \rangle = \lim_p \langle T_{\varphi_p}, \mathcal{F}(\psi) \rangle$. On the other hand, $|\langle T_{\varphi_p} - T, \mathcal{F}(\psi) \rangle| \leq \|T_{\varphi_p} - T\|_{H^s} \|\mathcal{F}(\psi)\|_{H^{-s}}$, and thus $\langle T_{\varphi_p}, \mathcal{F}(\psi) \rangle$ tends to $\langle T, \mathcal{F}(\psi) \rangle$. Therefore $\langle T_f, \mathcal{F}(\psi) \rangle = \langle T, \mathcal{F}(\psi) \rangle$, and $T = T_f$.

For (c), it follows from Problem 8 that for any fixed s and any multi-index α with $|\alpha| \leq s$, $\|D^\alpha \varphi\|_{H^{s-|\alpha|}} \leq C_\alpha \|\varphi\|_{H^s}$ for all φ in $\mathcal{S}(\mathbb{R}^N)$. Fix m with $s > N/2 + m$, and let T be in H^s . By Problem 9c we can choose a sequence φ_k in $\mathcal{S}(\mathbb{R}^N)$ such that T_{φ_k} tends to T in H^s . For $p \leq q$ and for each α with $|\alpha| \leq m$, (a) shows that $\|D^\alpha \varphi_p - D^\alpha \varphi_q\|_{\text{sup}} \leq C'_\alpha \|T_{D^\alpha \varphi_p} - T_{D^\alpha \varphi_q}\|_{H^{s-|\alpha|}} \leq C'_\alpha \|T_{D^\alpha \varphi_p} - T_{D^\alpha \varphi_q}\|_{H^{s-m}}$. Letting q tend to infinity, we see that $D^\alpha \varphi_p$ converges uniformly to some function f_α , necessarily continuous and bounded. By the theorem on interchange of limit and derivative, $f_0 = \lim_p D^0 \varphi_p$ is of class C^m with $f_\alpha = D^\alpha f_0$ for all α with $|\alpha| \leq m$. Then we can argue as in (b) to see that $T = T_f$, and (c) is proved.

13. In (a), $P_y * (u_0 + iHu_0)(x) = P_y * u_0(x) + iQ_y * u_0(x) = \frac{i\bar{z}}{\pi|z|^2} * u_0(x) = ((-i\pi z)^{-1}) * u_0(x)$. The left side is in \mathcal{H}^p since H is bounded on L^p , and the form of the right side shows that the result is analytic in the upper half plane. Hence the expression is in H^p .

In (b), we know that $f(x + iy) = P_y * u_0(x) + iQ_y * u_0(x) = P_y * u_0(x) + iP_y Hu_0(x)$. Taking the L^p limit as $y \downarrow 0$, we obtain $f_0 = u_0 + iHu_0$. Hence iHu_0 is the imaginary part of f_0 .

14. According to the previous problem, the functions in H^2 are those of the form $P_y * (u_0 + iHu_0)$ with u_0 in L^2 . That is, they are the functions of the form $u_0 + iHu_0$ with u_0 in L^2 . The operator H acts on the Fourier transform side by multiplication by $-i \operatorname{sgn} x$. Hence the Fourier transforms of the functions of interest are all expressions $\widehat{u}_0(x) + i(-i \operatorname{sgn} x)\widehat{u}_0(x)$ a.e. This function is $2\widehat{u}_0(x)$ for $x > 0$ and is 0 for $x < 0$. Conversely any function in L^2 is the Fourier transform of an L^2 function, and thus if g is given that vanishes a.e. for $x < 0$, we can find u_0 with $\widehat{u}_0 = \frac{1}{2}g$. Then $\widehat{u}_0 + i(-i \operatorname{sgn} x)\widehat{u}_0 = g$.

15. The first inequality is by the Schwarz inequality, and the second inequality is evident. For the equality we make the calculation

$$\begin{aligned} \Delta(|F|^q) &= 4 \frac{\partial}{\partial \bar{z}} \frac{\partial}{\partial z} (|F|^2)^{q/2} = 2q \frac{\partial}{\partial \bar{z}} [(|F|^2)^{\frac{q}{2}-1} \frac{\partial}{\partial z} (F, F)] \\ &= 2q \frac{\partial}{\partial \bar{z}} [(|F|^2)^{\frac{q}{2}-1} (F', F)] \\ &= q(q-2)(|F|^2)^{\frac{q}{2}-2} (F, F')(F', F) + 2q(|F|^2)^{\frac{q}{2}-1} (F', F') \\ &= q^2 |F|^{q-4} |(F, F')|^2 - 2q |F|^{q-4} |(F, F')|^2 + 2q |F|^{q-2} |F'|^2 \\ &= q^2 |F|^{q-4} |(F, F')|^2 + 2q |F|^{q-4} (-|(F, F')|^2 + |F|^2 |F'|^2). \end{aligned}$$

16. Arguing by contradiction, suppose that $u(x_1) > 0$ with $|x_1 - x_0| < r$. For any $c > 0$, the function $v_c(x) = u(x) + c(|x - x_0|^2 - r^2)$ has $\Delta v_c > 0$ on $B(r; x_0)$ and $v = u \leq 0$ on $\partial B(r; x_0)$. We can choose the positive number c sufficiently small so that $v_c(x_1) > 0$. Fix that c , and choose x_2 in $B(r; x_0)^{\text{cl}}$ where v_c is a maximum. Then x_2 is in $B(r; x_0)$, and all the first partial derivatives of v_c must be 0 there. Since $\Delta v_c(x_2) > 0$, we must have $D_j^2 v_c(x_2) > 0$ for some j , and then the presence of a maximum for $v - x$ at x_2 contradicts the second derivative test.

17. For (a), we calculate $\|g_\varepsilon\|_2^2 = \int_{\mathbb{R}} |g_\varepsilon(x)|^2 dx = \int_{\mathbb{R}} |F_\varepsilon(x)| dx \leq \int_{\mathbb{R}} |f(x+i\varepsilon)| dx + \varepsilon \int_{\mathbb{R}} |x+i|^{-2} \leq \|f\|_{H^1} + \varepsilon \|x+i\|_1^{-2}$.

In (b), the functions $x \mapsto g_\varepsilon(x+iy)$ and $x \mapsto F_\varepsilon(x+iy)$ are Poisson integrals of the functions with y replaced by $y/2$, and then are iterated Poisson integrals in passing from $y/2$ to $3y/4$ and to y . In the first case the starting function is in L^2 , and in the second case the starting function is in L^1 . The function at $3y/4$ is then in L^2 since $L^1 * L^2 \subseteq L^2$, and the function at y is continuous vanishing at infinity since $L^2 * L^2 \subseteq C_0(\mathbb{R})$. This handles the dependence for large x . For large y , we refer to the proof of Theorem 3.25, where we obtained the estimate $|u(x, t)|^p \leq [(\frac{1}{2}t_0)^{N+1} \Omega_1]^{-1} (N+1)t_0 \|u\|_{\mathcal{H}^p}^p$ if u is in \mathcal{H}^p and $t \geq t_0$.

In (c), the functions $|F_\varepsilon(z)|^{1/2}$ and $g_\varepsilon(z)$ are equal for $z = x$. Hence the continuous function $u(z) = |F_\varepsilon(z)|^{1/2} - g_\varepsilon(z)$ on \mathbb{R}_+^2 vanishes at $y = 0$ and tends to 0 as $|x| + |y|$ tends to infinity. Given $\delta > 0$, choose an open ball B large enough in \mathbb{R}_+^2 so that $u(z) \leq \delta$ off this ball. Since the second component of $F_\varepsilon(z)$ is nowhere vanishing, $|F_\varepsilon(z)|^{1/2}$ is everywhere smooth for $y > 0$. Problem 15 shows that $\Delta(|F_\varepsilon(z)|^{1/2}) \geq 0$, and we know that $\Delta g_\varepsilon(z) = 0$ since g_ε is a Poisson integral. Hence $\Delta u(z) \geq 0$. Applying Problem 16 on the ball B , we see that $u(z) \leq \delta$ on B . Hence $u(z) \leq \delta$ on \mathbb{R}_+^2 . Since δ is arbitrary, $u(z) \leq 0$ on \mathbb{R}_+^2 . Therefore $|F_\varepsilon(z)|^{1/2} \leq g_\varepsilon(z)$ on \mathbb{R}_+^2 .

18. In (a), the fact that P_y is in L^2 implies that $\lim_n \int_{\mathbb{R}} P_y(x-t)g_{\varepsilon_n}(t) dt = \int_{\mathbb{R}} P_y(x-t)g(t) dt$. Thus $g_{\varepsilon_n}(z) \rightarrow g(z)$ pointwise for $\text{Im } z > 0$. Then we have $|f(z)|^{1/2} \leq \limsup_n |f(z+i\varepsilon_n)|^{1/2} \leq \limsup_n g_\varepsilon(z) = g(z)$. Since $g(z)$ is the Poisson integral of $g(x)$, the inequality $g(x+iy) \leq Cg^*(x)$ is known from the given facts at the beginning of this group of problems.

In (b), we have $|f(x+iy)| \leq C^2 g^*(x)^2$, and we know that $\|g^*\|_2 \leq A_2 \|g\|_2$. From Problem 17a we have $\|g\|_2^2 \leq \limsup_n \|g_{\varepsilon_n}\|_2^2 \leq \limsup_n (\|f\|_{H^1} + \varepsilon \|x+i\|_1^{-2}) = \|f\|_{H^1}$.

19. Every f in $C_{\text{com}}(X)$ has $|\int_X f(x) d\nu(x)| = \lim_n |\int_X f(x)g_n(x) d\mu(x)| \leq \limsup_n \int_X |f(x)||g_n(x)| d\mu(x) \leq \int_X |f(x)| d\mu(x)$. If K is compact in X , we can find a sequence $\{f_k\}$ of functions ≥ 0 in $C_{\text{com}}(X)$ decreasing pointwise to the indicator function of K , and dominated convergence implies that $|\int_K d\nu(x)| \leq \int_K d\mu(x)$. In other words, $|\nu(K)| \leq \mu(K)$. Separating the real and imaginary parts of ν and then working with subsets of a maximal positive set for ν and a maximal negative set for ν , we reduce to the case that $\nu \geq 0$. Since ν is automatically regular, we obtain $\nu(E) \leq \mu(E)$ for all Borel sets E , and the absolute continuity follows.

20. Since f is in H^1 , it is in \mathcal{H}^1 and hence is the Poisson integral of a finite complex Borel measure ν , and the complex measures $f(x+i/n) dx$ converge weak-star against $C_{\text{com}}(\mathbb{R})$ to ν . Meanwhile, we have $|f(x+i/n)| \leq C^2 g^*(x)^2$ for all n . In Problem 19 take $d\mu(x) = C^2 g^*(x)^2 dx$. Then the complex measures $f(x+i/n)[C^2 g^*(x)^2]^{-1} d\mu(x)$ converge weak-star to ν . Problem 19 shows that ν is absolutely continuous with respect to $C^2 g^*(x)^2 dx$. Hence ν is absolutely continuous with respect to Lebesgue measure.

21. For (a), $\mathcal{F}(T\varphi)$ is the product of an L^∞ function and a Schwartz function. The rapid decrease of the Fourier transform translates into the existence of derivatives of all orders for the function itself. Hence Φ is locally bounded.

For (b), any x with $|x| \geq 1$ has

$$\Phi(x) = \lim_{y \downarrow 0} \int_{|y| \geq \varepsilon} \left(\frac{K(x-y)}{|x-y|^N} - \frac{K(x)}{|x|^N} \right) \varphi(y) dy.$$

Hence $|\Phi(x)|$ is

$$\leq \limsup_{y \downarrow 0} \int_{|y| \geq \varepsilon} \varphi(y) |K(x-y) - K(x)| \left| \frac{1}{|x-y|^N} - \frac{1}{|x|^N} \right| dy + \int_{\mathbb{R}^N} \varphi(y) \frac{|K(x-y) - K(x)|}{|x|^N} dy.$$

If $|x| \geq 2|y|$ for all y in the support of φ , two estimates in the text are applicable; these appear in the proof that the hypotheses of Lemma 3.29 are satisfied:

$$\left| \frac{1}{|x-y|^N} - \frac{1}{|x|^N} \right| \leq N3^N \frac{|y|}{|x|^{N+1}} \quad \text{and} \quad |K(x-y) - K(x)| \leq \psi\left(\frac{2|y|}{|x|}\right).$$

The smoothness of K makes $\psi(t) \leq Ct$ for small positive t . Since the y 's in question are all in the compact support of φ , both terms are bounded by multiples of $|x|^{-(N+1)}$.

Conclusion (c) is immediate from (a) and (b).

22. Part (a) is just a matter of tracking down the effects of dilations. Part (c) follows by dilating $\Phi = T\varphi - k$ to obtain $\Phi_\varepsilon = (T\varphi)_\varepsilon - k_\varepsilon$, by applying (a) to write $\Phi_\varepsilon = T\varphi_\varepsilon - k_\varepsilon$, by convolving with f , and by applying (b). Thus we have to prove (b).

For (b), we have $\varphi_\varepsilon * Tf = \varphi_\varepsilon * (\lim_\delta T_\delta f)$. The limit is in L^p , and convolution by the $L^{p'}$ function φ_ε is bounded from L^p to L^∞ . Therefore $\varphi_\varepsilon * (\lim_\delta T_\delta f)$ equals $\lim_\delta (\varphi_\varepsilon * (T_\delta f)) = \lim_\delta (\varphi_\varepsilon * (k_\delta * f))$. This is equal to $\lim_\delta ((\varphi_\varepsilon * k_\delta) * f) = \lim_\delta ((T_\delta \varphi_\varepsilon) * f)$ since φ_ε is in L^1 . Finally we can move the limit inside since $\lim_\delta T_\delta \varphi_\varepsilon$ can be considered as an $L^{p'}$ limit and f is in L^p .

23. From (c), we have $\sup_{\varepsilon > 0} |T_\varepsilon f(x)| = \sup_{\varepsilon > 0} |k_\varepsilon * f(x)| \leq \sup_{\varepsilon > 0} |\Phi_\varepsilon * f(x)| + \sup_{\varepsilon > 0} |\varphi_\varepsilon * (Tf)(x)| \leq C_\Phi f^*(x) + C_\varphi (Tf)^*(x)$, where C_Φ and C_φ are as in the given facts at the beginning of this group of problems.

24. Taking L^p norms in the previous problem and using Theorem 3.26 and the known behavior of Hardy–Littlewood maximal functions, we obtain

$$\begin{aligned} \left\| \sup_{\varepsilon > 0} |T_\varepsilon f(x)| \right\|_p &\leq C_\Phi \|f^*\|_p + C_\varphi \|(Tf)^*\|_p \leq C_\Phi A_p \|f\|_p + C_\varphi A_p \|Tf\|_p \\ &\leq C_\Phi A_p \|f\|_p + C_\varphi A_p C_p \|f\|_p = C \|f\|_p, \end{aligned}$$

where A_p and C_p are constants such that $\|f^*\|_p \leq A_p \|f\|_p$ and $\|Tf\|_p \leq C_p \|f\|_p$. We know that $\lim_{\varepsilon > 0} T_\varepsilon f(x)$ exists pointwise for f in the dense set $C_{\text{com}}^\infty(\mathbb{R}^N)$, and a familiar argument uses the above information to give the existence of the pointwise limit almost everywhere for all f in L^p .

25. This follows from the same argument as for Proposition 3.7.

26. Fix $\psi \geq 0$ in $C_{\text{com}}^\infty(\mathbb{R}^N)$ with integral 1, and define $\psi_\varepsilon(x) = \varepsilon^{-N} \psi(\varepsilon^{-1}x)$. If f is in $L_k^2(T^N)$, then $\psi_\varepsilon * f$ is smooth and periodic, hence is in $C^\infty(T^N)$. Suppose it is proved that

$$D^\alpha(\psi_\varepsilon * f) = \psi_\varepsilon * D^\alpha f \quad \text{for } |\alpha| \leq k. \quad (*)$$

If we let η be the indicator function of $[-2\pi, 2\pi]^N$, then Proposition 3.5a shows that $\lim_{\varepsilon \downarrow 0} \|\eta(\psi_\varepsilon * D^\alpha f - D^\alpha f)\|_2 = 0$ for $|\alpha| \leq k$, and then (*) shows that $\lim_{\varepsilon \downarrow 0} \|\eta(D^\alpha(\psi_\varepsilon * f) - D^\alpha f)\|_2 = 0$. Hence $\lim_{\varepsilon \downarrow 0} \|\psi_\varepsilon * f - f\|_{L_k^2(T^N)} = 0$.

For (*), the critical fact is that the smooth function $\psi * f$ is periodic. If φ is periodic and ψ_ε is supported inside $[-\pi, \pi]^N$, then

$$\begin{aligned} \int_{[-\pi, \pi]^N} (\psi_\varepsilon * D^\alpha f(x)) \varphi(x) dx &= \int_{[-\pi, \pi]^N} \int_{[-\pi, \pi]^N} \psi_\varepsilon(y) D^\alpha f(x-y) \varphi(x) dy dx \\ &= \int_{[-\pi, \pi]^N} \int_{[-\pi, \pi]^N} \psi_\varepsilon(y) D^\alpha f(x-y) \varphi(x) dx dy \\ &= (-1)^{|\alpha|} \int_{[-\pi, \pi]^N} \int_{[-\pi, \pi]^N} \psi_\varepsilon(y) f(x-y) D^\alpha \varphi(x) dx dy \\ &= (-1)^{|\alpha|} \int_{[-\pi, \pi]^N} (\psi_\varepsilon * f)(x) D^\alpha \varphi(x) dx \\ &= \int_{[-\pi, \pi]^N} (D^\alpha(\psi_\varepsilon * f)) \varphi dx, \end{aligned}$$

and (*) follows.

27. We have

$$\begin{aligned} \|D^\alpha f\|_{L_k^2(T^N)}^2 &= \sum_{|\beta| \leq k} (2\pi)^{-N} \int_{[-\pi, \pi]^N} |D^\beta D^\alpha f|^2 dx \\ &= \sum_{|\beta| \leq k} (2\pi)^{-N} \int_{[-\pi, \pi]^N} |D^{\alpha+\beta} f|^2 dx \\ &\leq \sum_{|\gamma| \leq k+|\alpha|} (2\pi)^{-N} \int_{[-\pi, \pi]^N} |D^\gamma f|^2 dx \\ &= \|f\|_{L_{k+|\alpha|}^2(T^N)}^2. \end{aligned}$$

Thus we can take $C_{\alpha,k} = 1$.

28. For each α , we have $(2\pi)^{-N} \int_{[-\pi, \pi]^N} |D^\alpha f|^2 dx \leq (\sup_{x \in [-\pi, \pi]^N} |D^\alpha f(x)|)^2$. Summing for $|\alpha| \leq k$ gives

$$\|f\|_{L_k^2(T^N)}^2 \leq \sum_{|\alpha| \leq k} (\sup_{x \in [-\pi, \pi]^N} |D^\alpha f(x)|)^2,$$

and the right side is $\leq (\sum_{|\alpha| \leq k} \sup_{x \in [-\pi, \pi]^N} |D^\alpha f(x)|)^2$. Thus we can take $A_k = 1$.

29. Since $l_j^2 \leq |l|^2$, we have $l^{2\alpha} \leq (|l|^2)^{|\alpha|} \leq (1 + |l|^2)^k$, and the left inequality of the problem follows with B_k equal to the reciprocal of the number of α 's with $|\alpha| \leq k$. For the right inequality, we have $1 + |l|^2 = \sum_{|\alpha| \leq 1} l^{2\alpha}$. Raising both sides to the k^{th} power gives the desired result once the right side is expanded out since $l^{2\alpha} l^{2\beta} = l^{2(\alpha+\beta)}$.

30–31. For f in $C^\infty(T^N)$, let f have Fourier coefficients c_l . The l^{th} Fourier coefficient of $D^\alpha f$ is then $i^{|\alpha|} l^\alpha c_l$, and hence $\|D^\alpha f\|_2^2 = \sum_l |c_l|^2 l^{2\alpha}$. Consequently $\|f\|_{L_k^2(T^N)} = \sum_l |c_l|^2 (\sum_{|\alpha| \leq k} l^{2\alpha})$. Then the estimate required for Problem 31 in the case of functions in $C^\infty(T^N)$ is immediate from the inequalities of Problem 29.

Problem 26 shows that $C^\infty(T^N)$ is dense in $L_k^2(T^N)$. Let f be given in $L_k^2(T^N)$, and choose $f^{(n)}$ in $C^\infty(T^N)$ convergent to f in $L_k^2(T^N)$. Since $f^{(n)}$ tends to f in L^2 , the Fourier coefficients $c_l^{(n)}$ of $f^{(n)}$ tend to those c_l of f for each l . Applying Problem 29 to each $f^{(n)}$ and using Fatou's Lemma, we obtain $\sum_l |c_l|^2 (1 + |l|^2)^k \leq C_k \|f\|_{L_k^2(T^N)}^2$. On the other hand, if f is given in $L_k^2(T^N)$ with Fourier coefficients c_l , then we can put $f^{(n)}(x) = \sum_{|l| \leq n} c_l e^{il \cdot x}$. Since $f^{(n)}$ is given by a finite sum and since $D^\alpha f(x) = \sum_l c_l l^\alpha e^{il \cdot x}$ in the L^2 sense for $|\alpha| \leq k$, we see that $f^{(n)}$ converges to f in $L_k^2(T^N)$. The left inequality of Problem 31 holds for each $f^{(n)}$ since $f^{(n)}$ is in $C^\infty(T^N)$, and the expression in the middle of that inequality for $f^{(n)}$ is \leq the corresponding expression for f . Passing to the limit, we obtain the left inequality of Problem 31 for f .

This settles Problem 31. It shows also that if f is in $L_k^2(T^N)$, then we have $\sum_l |c_l|^2 (1 + |l|^2)^k < \infty$. On the other hand, if this sum is finite, then we define $f^{(n)}$ to be $\sum_{|l| \leq n} c_l e^{il \cdot x}$. Problem 31 gives us $B_k \|f^{(n)}\|_{L_k^2(T^N)}^2 \leq \sum_l |c_l|^2 (1 + |l|^2)^k$ for each n . Each $D^\alpha f^{(n)}$ for $|\alpha| \leq k$ is convergent to something in L^2 , and the completeness of $L_k^2(T^N)$ proved in Problem 25 shows that $f^{(n)}$ converges to something in $L_k^2(T^N)$. Consideration of Fourier coefficients shows that the limit function must be f . Hence f is in $L_k^2(T^N)$.

32. Put $c = K/N > 1/2$. Term by term we have $\sum_{l \in \mathbb{Z}^N} (1 + |l|^2)^{-(N+1)/2} \leq \sum_{l_1 \in \mathbb{Z}} \cdots \sum_{l_N \in \mathbb{Z}} (1 + l_1^2)^{-c} \cdots (1 + l_N^2)^{-c} = \prod_{j=1}^N (\sum_{m \in \mathbb{Z}} (1 + m^2)^{-c})$, and the right side is finite since $c > 1/2$. This proves convergence of the sum.

Now suppose that f is in $L_K^2(T^N)$, and suppose that f has Fourier coefficients c_l . Problem 31 shows that $\sum_l |c_l|^2 (1 + |l|^2)^K < \infty$. The Schwarz inequality gives

$$\begin{aligned} \sum_l |c_l| &= \sum_l |c_l (1 + |l|^2)^{K/2} (1 + |l|^2)^{-K/2}| \\ &\leq \left(\sum_l |c_l|^2 (1 + |l|^2)^K \right)^{1/2} \left(\sum_l (1 + |l|^2)^{-K} \right)^{1/2}, \end{aligned}$$

and we conclude that $\sum_l |c_l| < \infty$. Therefore the partial sums of the Fourier series of f converge to a continuous function. This continuous function has to match the L^2 limit almost everywhere, and the latter is f .

33. Let c_l be the Fourier coefficients of f . If f is in $L_K^2(T^N)$ with $K > N/2$, then Problem 32 shows that f is continuous and is given pointwise by the sum of its Fourier series. The inequalities in the solution for that problem show that $|f(x)| \leq \sum_l |c_l| \leq A_K \left(\sum_l |c_l|^2 (1 + |l|^2)^{-K} \right)^{1/2}$. In turn, Problem 31 shows that the right side is $\leq A_K C_k^{1/2} \|f\|_{L_k^2(T^N)}$. This gives the desired estimate for $\alpha = 0$

with $m(0) = K$ for any integer K greater than $N/2$. Combining this estimate with the result of Problem 27, we obtain an inequality for all α , with $m(\alpha) = K + |\alpha|$ and $C_\alpha = A_K C_K^{1/2}$.

34. The comparisons of size are given in Problems 28 and 33. These comparisons establish the uniform continuity of the identity map in both directions, by the proof of Proposition 3.2. (The statement of the proposition asserts only continuity.)

Chapter IV

1. With the explicit definition of the norm topology on X/Y , we have $\|x + Y\| \leq \|x\|$, and consequently the quotient mapping $q : X \rightarrow X/Y$ is continuous onto the normed X/Y . Because of completeness the Interior Mapping Theorem applies and shows that the quotient mapping carries open sets to open sets. Consequently a subset E of X/Y in the norm topology is open if and only if $q^{-1}(E)$ is open. This is the same as the defining condition for a subset of X/Y to be open in the quotient topology, and hence the topologies match.

2. Let $K = \ker(T)$, and let $q : X \rightarrow X/K$ be the quotient map. By linear algebra the map $T : X \rightarrow Y$ induces a one-one linear map $T' : X/K \rightarrow Y$, and then $T = T' \circ q$. Since K is closed in X , Proposition 4.4 shows that X/K is a topological vector space. Since $T(X)$ is finite dimensional and T' is one-one, X/K is finite dimensional. Proposition 4.5 implies that T' is continuous. Since T is the composition of continuous maps, it is continuous.

3. Let $T : X \rightarrow Y$ be a continuous linear map from one Banach space onto another, and let $K = \ker T$. As in Problem 2, write $T = T' \circ q$, where $q : X \rightarrow X/K$ is the quotient mapping. Here T' is one-one. Since a subset E of X/K is open if and only if $q^{-1}(E)$ is open, T' is continuous. Problem 1 shows that the topology on X/K comes from a Banach space structure. By the assumed special case of the Interior Mapping Theorem, T' carries open sets to open sets. Therefore the composition T carries open sets to open sets.

4. This follows from Proposition 4.5.

5. Take x_n to be the n^{th} member of an orthonormal basis. Then $\|x_n\| = 1$ for all n . Any u in H has an expansion $u = \sum_{n=1}^{\infty} c_n x_n$, convergent in H , with $c_n = (u, x_n)$ and $\sum |c_n|^2 < \infty$. Then $\{(u, x_n)\}$ tends to 0 for each u , and $\{x_n\}$ therefore tends to 0 weakly.

6. The weak convergence implies that $\lim_n (f_n, f) = (f, f) = \|f\|^2$. Therefore $\|f_n - f\|^2 = \|f_n\|^2 - 2 \operatorname{Re}(f_n, f) + \|f\|^2$ tends to $\|f\|^2 - 2\|f\|^2 + \|f\|^2 = 0$.

7. Let the dense subset of X^* be D . For x^* in X^* and y^* in D , we have

$$\begin{aligned} |x^*(x_n) - x^*(x_0)| &\leq |(x^* - y^*)(x_n)| + |y^*(x_n) - y^*(x_0)| + |(y^* - x^*)(x_0)| \\ &\leq \|x^* - y^*\| \|x_n\| + |y^*(x_n) - y^*(x_0)| + \|x^* - y^*\| \|x_0\| \\ &\leq (C + \|x_0\|) \|x^* - y^*\| + |y^*(x_n) - y^*(x_0)|, \end{aligned}$$

where $C = \sup_n \|x_n\|$. Given $x^* \in X^*$ and $\epsilon > 0$, choose y^* in D to make the first term on the right be $< \epsilon$, and then choose n large enough to make the second term $< \epsilon$.

8. For (a), let $D(f) = 1$. Then $t \mapsto \int_{[0,t]} |f|^p dx$ is a continuous nondecreasing function on $[0, 1]$ that is 0 at $t = 0$ and is 1 at $t = 1$. Therefore there exists a partition $0 = a_0 < a_1 < \cdots < a_n = 1$ of $[0, 1]$ such that $\int_{[0,a_j]} |f|^p dx = j/n$ for $0 \leq j \leq n$. If f_j for $j \geq 1$ is the product of n and the indicator function of $[a_{j-1}, a_j]$, then $D(f_j) = \frac{1}{n} n^p = n^{-(1-p)}$, and $f = \frac{1}{n}(f_1 + \cdots + f_n)$.

For (b), let $g_j = cf_j$ in (a), so that $D(g_j) = |c|^p D(f_j) = |c|^p n^{-(1-p)}$. If we put $c = n^{(1-p)/p}$, then $D(g_j) = 1$. Thus we obtain the expansion $n^{(1-p)/p} f = \frac{1}{n}(g_1 + \cdots + g_n)$ with $D(g_j) = 1$ for each j . Since $D(n^{(1-p)/p} f) = n^{1-p} D(f) = n^{1-p}$, the multiple $n^{(1-p)/p} f$ of f is a convex combination of functions h with $D(h) \leq 1$. Taking a convex combination of 0 and this multiple of f shows that rf is a convex combination of functions h with $D(h) \leq 1$ if $0 \leq r \leq n^{(1-p)/p}$. Since $\sup_n n^{(1-p)/p} = +\infty$, every nonnegative multiple of f is a convex combination of functions h with $D(h) \leq 1$.

For (c), we scale the result of (b). The smallest convex set containing all functions $\epsilon^{1/p} h$ with $D(h) \leq 1$ contains all nonnegative multiples of f . Since $D(\epsilon^{1/p} h) = \epsilon D(h)$, the smallest convex set containing all functions k with $D(k) \leq \epsilon$ contains all nonnegative multiples of f . Since f is arbitrary, this convex set is all of $L^p([0, 1])$.

For (d), the sets where $D(f) \leq \epsilon$ form a local neighborhood base at 0. Thus if $L^p([0, 1])$ were locally convex, then any convex open set containing 0 would have to contain, for some $\epsilon > 0$, the set of all f with $D(f) \leq \epsilon$. But the only convex set containing all f with $D(f) \leq \epsilon$ is all of $L^p([0, 1])$ by (c). Hence $L^p([0, 1])$ is not locally convex.

For (e), suppose that ℓ is a continuous linear functional on $L^p([0, 1])$. Then we can find some $\epsilon > 0$ such that $D(f) < \epsilon$ implies $\operatorname{Re} \ell(f) < 1$. The set of all f where $\operatorname{Re} \ell(f) < 1$ is a convex set, and it contains the set of all f with $D(f) < \epsilon$. But we saw in (c) that the only such convex set is $L^p([0, 1])$ itself. Therefore $\operatorname{Re} \ell(f) < 1$ for all f in $L^p([0, 1])$. Using scalar multiples, we see that $\operatorname{Re} \ell(f) = 0$ for all f . Therefore $\ell(f) = 0$, and the only continuous linear functional ℓ on $L^p([0, 1])$ is $\ell = 0$.

9. In (a), if φ is compactly supported in K_{p_0} , then $\epsilon_p^{-1} \sup_{x \notin K_p} \sup_{|\alpha| \leq m_p} |D^\alpha \varphi(x)|$ is 0 for $p \geq p_0$. Thus $\|\varphi\|_{m,\epsilon}$ is a supremum for $p < p_0$ of finitely many expressions that are each finite for any smooth function on U . Hence $\|\varphi\|_{m,\epsilon}$ is finite. Conversely if φ is not compactly supported, then the expressions $s_p = \sup_{x \notin K_p} |\varphi(x)|$ have $0 < s_p \leq \infty$ for all p . If we define the sequence ϵ by $\epsilon_p = \min(p^{-1}, s_p)$, then ϵ_p decreases to 0 and every sequence m has $\|\varphi\|_{m,\epsilon} \geq \epsilon_p^{-1} \sup_{x \notin K_p} |\varphi(x)| \geq p$ for all p . Since p is arbitrary, $\|\varphi\|_{m,\epsilon} = \infty$.

For (b), we have only to show that the inclusion of $C_{K_p}^\infty$ into $(C_{\text{com}}^\infty(U), \mathcal{T}')$ is continuous for every p . If (m, ϵ) is given, we are to find an open neighborhood of 0 in

$C_{K_p}^\infty$ such that $\|\varphi\|_{m,\varepsilon} < 1$ for all φ in this neighborhood. Put $M = \max(m_1, \dots, m_p)$ and $\delta = \min(\varepsilon_1, \dots, \varphi_p)$. If φ is supported in K_p and $\sup_{x \in K_p} \sup_{|\alpha| \leq M} |D^\alpha \varphi(x)| < \delta$, then $\varepsilon_r^{-1} \sup_{x \notin K_r} \sup_{|\alpha| \leq m_r} |D^\alpha \varphi(x)|$ is 0 for $r \geq p$ and is < 1 for $r < p$. Therefore its supremum on r , which is $\|\varphi\|_{m,\varepsilon}$, is < 1 .

For (c), define $m_p = \max\{p, n_1, \dots, n_p\}$ for each p , and then $\{m_p\}$ is monotone increasing and tends to infinity. Next choose C_p for each p by the compactness of the support of ψ_p and the use of the Leibniz rule on $\psi_p \eta$ so that whenever $|D^\alpha \eta(x)| \leq c$ for some $\eta \in C^\infty(U)$, all $x \notin K_p$, and all α with $|\alpha| \leq m_p$, then $2^{p+1} |D^\alpha(\psi_p \eta)(x)| \leq C_p c$ for that η , all $x \in U$, and all α with $|\alpha| \leq m_p$. Choose ε_p to be $< \delta_p / C_p$ and to be such that $\{\varepsilon_p\}$ is monotone decreasing and has limit 0. If $\|\varphi\|_{m,\varepsilon} < 1$, then $\sup_{x \notin K_p} \sup_{|\alpha| \leq m_p} |D^\alpha \varphi(x)| < \varepsilon_p$ for all p . Taking $\eta = \varphi$ in the definition of C_p , we see that $\sup_{x \in U} \sup_{|\alpha| \leq m_p} 2^{p+1} |D^\alpha(\psi_p \varphi)(x)| \leq C_p \varepsilon_p < \delta_p$. Since $\psi_p \varphi$ is in $C_{K_{p+3}}^\infty$ and $m_p \geq n_p$, we see that $2^{p+1} \psi_p \varphi$ meets the condition for being in $N \cap C_{K_{p+3}}^\infty$.

For (d), we see from (c) that $2^{p+1} \psi_p \varphi$ is in N for all $p \geq 0$. The expansion $\varphi = \sum_{p \geq 0} 2^{-(p+1)} (2^{p+1} \psi_p \varphi)$ is a finite sum since φ has compact support, and it therefore exhibits φ as a convex combination of the 0 function and finitely many functions $2^{p+1} \psi_p \varphi$, each of which is in N . Since N is convex, φ is in N . This proves the asserted continuity.

For (e), each vector subspace $C_{K_p}^\infty$ is closed nowhere dense, and the union of these subspaces is all of $C_{\text{com}}^\infty(U)$.

10. Disproof: The answer is certainly independent of H , and we can therefore specialize to $H = L^2([0, 1])$. The multiplication algebra by $L^\infty([0, 1])$ is isometric to a subalgebra of $\mathcal{B}(H, H)$ and is not separable. Therefore $\mathcal{B}(H, H)$ is not separable.

11. Certainly $\mathcal{A}' \supseteq \mathcal{M}(L^2(S, \mu))$. Let T be in \mathcal{A}' , and put $g = T(1)$. For f continuous, $Tf = T(f1) = TM_f 1 = M_f T 1 = M_f g = fg = gf$. If we can prove that g is in $L^\infty(S, \mu)$, then T and M_g will be bounded operators equal on the dense subset $C(S)$ of $L^2(S, \mu)$ and therefore equal everywhere. Let $E_N = \{x \mid N \leq |g(x)| \leq N + 1\}$, and suppose that $\mu(E_N) > 0$. We shall derive an upper bound for N . Choose a compact set $K_N \subseteq E_N$ with $\mu(K_N) > 0$. Then choose f in $C(S)$ with values in $[0, 1]$ such that $f \geq 1$ on K_N and $\int_S f d\mu \leq 2\mu(K_N)$. Then $\int_S |gf|^2 d\mu \geq \int_{K_N} |gf|^2 d\mu = \int_{K_N} |g|^2 d\mu \geq N^2 \mu(K_N)$. Also, $\int_S |f|^2 d\mu \leq \int_S f d\mu \leq 2\mu(K_N)$ since $0 \leq f \leq 1$. Therefore $N\mu(K_N)^{1/2} \leq \|gf\|_2 \leq \|T\| \|f\|_2 \leq \sqrt{2} \|T\| \mu(K_N)^{1/2}$, and we obtain $N \leq \sqrt{2} \|T\|$. This gives an upper bound for N and shows that g is in $L^\infty(S, \mu)$.

12. The Spectral Theorem shows that we may assume that A is of the form M_g and acts on $H = L^2(S, \mu)$, with g in $L^\infty(S, \mu)$. Certainly we have $\sup_{\|f\|_2 \leq 1} |(M_g f, f)| \leq \|g\|_\infty$. Let us prove the reverse inequality. Lemma 4.55 and Proposition 4.43 show that $\|g\|_\infty$ is the supremum of the numbers $|\lambda_0|$ such that λ_0 is in the essential image of M_g . For λ_0 in the essential image, fix $\varepsilon > 0$ and let f_1 be the indicator function of

$g^{-1}(\{|\lambda - \lambda_0| < \epsilon\})$. Then

$$\int_S g|f_1|^2 d\mu = \int_{|g(x) - \lambda_0| < \epsilon} g d\mu = \lambda_0 \mu(|g(x) - \lambda_0| < \epsilon) + \int_{|g(x) - \lambda_0| < \epsilon} (g - \lambda_0) d\mu.$$

The last term on the right is $\leq \epsilon \mu(|g(x) - \lambda_0| < \epsilon)$ in absolute value. Hence $\int_S g|f_1|^2 d\mu = (\lambda_0 + \zeta) \mu(|g(x) - \lambda_0| < \epsilon)$ with $|\zeta| \leq \epsilon$. Dividing by $\|f_1\|_2^2 = \mu(|g(x) - \lambda_0| < \epsilon)$ and setting $f = f_1/\|f_1\|_2$, we obtain $|\int_S g|f|^2 d\mu - \lambda_0| \leq \epsilon$. Since ϵ is arbitrary, λ_0 is in the closure of $\{(M_g f, f) \mid \|f\|_2 = 1\}$. Taking the supremum over λ_0 in the essential image, we obtain $\sup_{\|f\|_2 \leq 1} |(M_g f, f)| \geq \|g\|_\infty$.

13. This is what the proof of Theorem 4.53 gives when the assumption that \mathcal{A} is maximal is dropped and the cyclic vector is produced by a hypothesis rather than by Proposition 4.52.

14. Apply the previous problem. Proposition 4.63 shows that \mathcal{A}_m^* is canonically homeomorphic to $\sigma(A)$. Under this identification we want to see that UAU^{-1} is multiplication by z . Thus let $\psi : \sigma(A) \rightarrow \mathcal{A}_m^*$ be the homeomorphism obtained from the proposition. The solution of the previous problem and the proof of Theorem 4.53 show that UAU^{-1} is multiplication by \hat{A} when we work with \mathcal{A}_m^* , and it is therefore $\hat{A} \circ \psi$ when we work with $\sigma(A)$. The defining property of ψ is that $f(z) = f \circ \hat{A}(\psi(z))$ for $f \in C(\sigma(A))$ and $z \in \sigma(A)$. This equation for the function $f(z) = z$ says that $\hat{A} \circ \psi(z) = z$, and hence UAU^{-1} is multiplication by z on $\sigma(A)$.

15. For (a), \mathcal{A} immediately contains all M_P for arbitrary polynomials P with complex coefficients on $[0, 1]$. By the Stone–Weierstrass Theorem, \mathcal{A} contains all operators M_f with f continuous on $[0, 1]$. This collection of operators is an algebra closed under adjoints and operator limits (which are the same as essentially uniform limits of the functions), and hence it exhausts \mathcal{A} . If we then form $\mathcal{A}1$, we obtain all continuous functions in $L^2([0, 1])$, and these are dense. Hence 1 is cyclic.

For (b), Proposition 4.63 says that the spectrum may be identified with $\sigma(M_x)$, and Lemma 4.55 shows that this is $[0, 1]$.

In (c), the system of operators M_φ satisfies conditions (a) through (d) for the system $\varphi(M_x)$ of Theorem 4.57. By uniqueness, $\varphi(M_x) = M_\varphi$ for every bounded Borel function on $[0, 1]$.

17. If $0 < \mu(S) < 1$, then μ is a nontrivial convex combination of 0 and a measure with total mass 1 and is therefore not extreme. Since 0 is evidently extreme, the problem is to identify the extreme measures among those with total mass 1. If μ is given with $\mu(S) = 1$ and if some Borel set E has $0 < \mu(E) < 1$, define $\mu_1(A) = \mu(E)^{-1} \mu(E \cap A)$ and $\mu_2 = \mu(E^c)^{-1} \mu(E^c \cap A)$. Then μ_1 and μ_2 have total mass 1, and the equality $\mu = \mu(E)\mu_1 + \mu(E^c)\mu_2$ shows that μ is not extreme.

Thus we may assume that μ takes on only the values 0 and 1. In this case the regularity of μ implies that μ is a point mass, as is shown in Problem 6 of Chapter XI of *Basic*.

18. For (a), we have $f = (1 - t)\|f_1\|_1^{-1} f_1 + t\|f_2\|_1^{-1} f_2$ with $t = \|f_2\|_1$. For (b), we observe for any f in $L^1([0, 1])$ with $\|f\|_1 = 1$ that $t \mapsto \int_{[0, t]} |f| dx$ is

continuous on $[0, 1]$, is 0 at $t = 0$, and is 1 at $t = 1$. Therefore there exists some t_0 with $\int_{[0, t_0]} |f| dx = \frac{1}{2}$. The set $E = [0, t_0]$ is then a set to which we can apply (a) to see that f is not an extreme point of the closed unit ball.

19. For the compactness of K in (a), we are to show that the set of invariant measures is closed. Such measures μ have $\int_S f d\mu = \int_S (f \circ F) d\mu$ for all $f \in C(S)$. If we have a net $\{\mu_n\}$ of such measures convergent weak-star to μ , then we can pass to the limit in the equality for each μ_n and obtain $\int_S f d\mu = \int_S (f \circ F) d\mu$ for the limit μ since f and $f \circ F$ are both continuous. If we define $\nu(E) = \mu(F^{-1}(E))$, this equality says that $\int_S f d\mu = \int_S f d\nu$ for every $f \in C(S)$. By the uniqueness in the Riesz Representation Theorem, $\mu = \nu$. Therefore the limit μ is invariant under F .

In (b), if μ could be extreme but not ergodic, we could find a Borel set E with $0 < \mu(E) < 1$ such that $F(E) = E$. Put $\mu_1(A) = \mu(E)^{-1}\mu(A \cap E)$ and $\mu_2(A) = \mu(E^c)^{-1}\mu(A \cap E^c)$. The invariance of the set E implies that μ_1 and μ_2 are invariant. Since $\mu = \mu(E)\mu_1 + \mu(E^c)\mu_2$, μ is exhibited as a nontrivial convex combination of invariant measures and cannot be extreme.

For (c), the answer is “no.” Take S to be a two-point set with the discrete topology, and let F interchange the two points. Then every measure μ on S with $\mu(S) = 1$ is ergodic, but only the two point masses are extreme points.

20. For (a) the assumed condition on f for the function $c(n)$ that is nonzero at $n = 0$ and is 0 elsewhere shows that $f(0) \geq 0$. The condition on f for the function $c(n)$ that is nonzero at 0 and k and is 0 elsewhere is that the matrix $\begin{pmatrix} f(0) & f(k) \\ f(-k) & f(0) \end{pmatrix}$ is Hermitian and positive semidefinite. The Hermitian condition forces $f(-k) = \overline{f(k)}$, and the condition determinant ≥ 0 then says that $|f(k)|^2 \leq f(0)^2$.

For (b), Example 2 of weak-star convergence in Section 3 says that a necessary and sufficient condition for a sequence $\{f_n\}$ in L^∞ to converge to f weak-star is that $\{\|f_m\|_\infty\}$ be bounded, which we are assuming, and that $\int_E f_n d\mu \rightarrow \int_E f d\mu$ for every E of finite measure. Here the sets of finite measure in \mathbb{Z} are the finite sets, and thus the relevant convergence is pointwise convergence.

For (c), Theorem 4.14 shows that the weak-star topology on the closed unit ball of $L^\infty(\mathbb{Z})$ is compact metric, and therefore the topology is specified by sequences. The convexity of K is routine, and we just have to see that K is closed. We can do this by assuming that we have a pointwise convergent sequence whose members are in K and by proving that the limit is in K . This too is routine.

For (d), suppose that $e^{in\theta} = (1-t)F_1(n) + tF_2(n)$ nontrivially. Taking the absolute value and using (a), we have $1 \leq (1-t)|F_1(n)| + t|F_2(n)| \leq (1-t) + t = 1$, and equality must hold throughout. Therefore $|F_1(n)| = |F_2(n)| = 1$. Suppressing the parameter n , suppose that we have $e^{i\psi} = (1-t)e^{i\varphi_1} + te^{i\varphi_2}$ nontrivially. Multiplying through by $e^{-i\psi}$, we reduce to the case that $\psi = 0$. So we have $1 = (1-t)e^{i\varphi_1} + te^{i\varphi_2}$. The real part is $1 = (1-t)\cos\varphi_1 + t\cos\varphi_2$, and we must have $\cos\varphi_1 = \cos\varphi_2 = 1$ and $e^{i\varphi_1} = e^{i\varphi_2} = 1$. Hence $F_1(n) = e^{in\theta} = F_2(n)$, and $n \mapsto e^{in\theta}$ is an extreme point.

For (e), the Fourier coefficient mapping from complex Borel measures on the circle to doubly infinite sequences is linear and one-one, and we are told to assume that the mapping carries the set of Borel measures onto the set of positive definite functions. The value of the positive definite function at 0 is then the total measure of the circle. Hence the question translates into identifying the extreme Borel measures of total mass 1 on the circle. Problem 17 shows that these are the point masses.

21. For (a), the convergence is proved by showing that the partial sums form a Cauchy sequence. For $m \leq n$, we have $\left\| \sum_{k=0}^n (f/C)^k - \sum_{k=0}^m (f/C)^k \right\|_{\text{sup}} = \left\| \sum_{k=m+1}^n (f/C)^k \right\|_{\text{sup}} \leq \sum_{k=m+1}^n \|f/C\|_{\text{sup}}^k$, and the right side tends to 0 as m and n tend to infinity because $\|f/C\|_{\text{sup}} = |C|^{-1} \|f\|_{\text{sup}} < 1$. So the series converges to some x . Since $(\sum_{k=0}^n (f/C)^k)(1 - f/C) = 1 - (f/C)^{n+1}$ and since multiplication is continuous, the element x is a multiplicative inverse to $1 - f/C$.

In (b), $\ell(f) = C$ would imply $\ell(1 - f/C) = \ell(1) - \ell(f)/C = 0$. But then $0 = 0 \cdot \ell(x) = \ell(1 - f/C)\ell(x) = \ell(1) = 1$ would give a contradiction.

From (b) we obtain $|\ell(f)| \leq 1$. Taking the supremum over all f with $\|f\|_{\text{sup}} \leq 1$, we find that $\|\ell\| \leq 1$. Thus ℓ is bounded. This proves (c).

22. Problem 21 shows that ℓ is bounded. The result follows by using the Stone Representation Theorem and the first example after its proof.

23. If t is in T , define $\ell_{u(t)}(f) = (Uf)(t)$ for f in $C(S)$. It is routine to check that ℓ_t satisfies the hypotheses of Problem 22 and is therefore given by evaluation at some s in S . Define this s to be $u(t)$. The proofs of (a), (b), and (c) are then straightforward.

24. This is just a matter of applying Problem 23 and tracking down the isomorphisms.

25. Let S be a nonempty set, and let \mathcal{A} be a uniformly closed subalgebra of $B(S)$ with the properties that \mathcal{A} is stable under complex conjugation and contains 1. If S_2 is a compact Hausdorff space and $V : \mathcal{A} \rightarrow C(S_2)$ is an algebra isomorphism mapping 1 to 1 and respecting conjugation and if S_1 , p , and U are as in Theorem 4.15, then there exists a unique homeomorphism $\Phi : S_2 \rightarrow S_1$ such that $(Uf)(\Phi(s_2)) = (Vf)(s_2)$ for all f in \mathcal{A} . Then one has to give a proof.

26. For (a), the reflexive and symmetric properties are immediate from the definition. For the transitive property let $x_i \sim x_j$ and $x_j \sim x_l$. Say that $i \leq k$, $j \leq k$, $\psi_{ki}(x_i) = \psi_{kj}(x_j)$, $j \leq m$, $l \leq m$, $\psi_{mj}(x_j) = \psi_{ml}(x_l)$. Choose n with $k \leq n$ and $m \leq n$. Application of ψ_{nk} to $\psi_{ki}(x_i) = \psi_{kj}(x_j)$ gives $\psi_{ni}(x_i) = \psi_{nj}(x_j)$, and application of ψ_{nm} to $\psi_{mj}(x_j) = \psi_{ml}(x_l)$ gives $\psi_{nj}(x_j) = \psi_{nl}(x_l)$. Therefore $\psi_{ni}(x_i) = \psi_{nl}(x_l)$, and \sim is transitive.

For (b), suppose that $\psi_{ki}(x_i) = \psi_{kj}(x_j)$. We are to show that $\psi_{li}(x_i) = \psi_{lj}(x_j)$ whenever $i \leq l$ and $j \leq l$. Assume the contrary for some l . Choose m with $k \leq m$ and $l \leq m$. Application of ψ_{mk} to $\psi_{ki}(x_i) = \psi_{kj}(x_j)$ gives $\psi_{mi}(x_i) = \psi_{mj}(x_j)$. On the other hand, application of ψ_{ml} to $\psi_{li}(x_i) \neq \psi_{lj}(x_j)$ gives $\psi_{mi}(x_i) \neq \psi_{mj}(x_j)$ since ψ_{ml} is by assumption one-one. Thus we have a contradiction.

27. Suppose that we are given maps $\varphi_i : W_i \rightarrow Z$ with $\varphi_j \circ \psi_{ji} = \varphi_i$ whenever $i \leq j$. Define $\tilde{\Phi} : \coprod W_i \rightarrow Z$ by $\tilde{\Phi}(x_j) = \varphi_j(x)$ if x_j is in W_j . The map $\tilde{\Phi}$ is continuous, and the claim is that it descends to the quotient to give a map Φ satisfying $\Phi(q(x_j)) = \tilde{\Phi}(x_j)$. To see the necessary consistency, suppose $x_j \sim x_l$ with x_l in W_l . Say that $j \leq k$, $l \leq k$, and $\psi_{kj}(x_j) = \psi_{kl}(x_l)$. Then we have $\tilde{\Phi}(x_j) = \varphi_j(x_j) = \varphi_k \psi_{kj}(x_j) = \varphi_k \psi_{kl}(x_l) = \varphi_l(x_l) = \tilde{\Phi}(x_l)$, and the consistency is proved. The definition of Φ is complete, and we have arranged that $\Phi \circ (q|_{W_j}) = \varphi_j$ for each j . This establishes existence of the map Φ in the universal mapping property. Since q carries $\coprod W_i$ onto W , the formulas $\Phi \circ (q|_{W_j}) = \varphi_j$ force the definition we have used for Φ . This establishes the uniqueness of the map Φ in the universal mapping property.

28. With $(V, \{p_i\})$ as a direct limit, take $Z = W$ and $\varphi_i = q_i$. Each map φ_i carries W_i into Z , and the universal mapping property of $(V, \{p_i\})$ yields a mapping $F : V \rightarrow W$ with $q_i = F \circ p_i$ for all i . Reversing the roles of $(V, \{p_i\})$ and $(W, \{q_i\})$, we obtain a mapping $G : V \rightarrow W$ with $p_i = G \circ q_i$ for all i .

With $(V, \{p_i\})$ as a direct limit, take $Z = V$ and $\varphi_i = p_i$. Then the identity $1|_V$ meets the condition of the universal mapping property for this situation. On the other hand, so does $G \circ F$, which carries V to itself and has $p_i = G \circ q_i = (G \circ F) \circ p_i$. By the uniqueness that is part of the universal mapping property, $G \circ F = 1|_V$. Similarly $F \circ G = 1|_W$. Thus F is a homeomorphism.

The homeomorphism F is unique because any such mapping $F^\#$ must similarly have $G \circ F^\# = 1|_V$ and $F^\# \circ G = 1|_W$. Thus $F^\#$ must be a two-sided inverse to G , and there can be only one such function.

29. For (a), let U be an open set in $\coprod W_i$. We are to prove that $q(U)$ is open. Since each W_i is open in the disjoint union, we may assume that $U \subseteq W_i$ for some i . We are to prove that $q^{-1}(q(U))$ is open, hence that $q^{-1}(q(U)) \cap W_j$ is open for each j . Thus we are to show that the set V of all x_j in W_j such that $x_j \sim x_i$ for some x_i in U is open in W_j . Choose k with $i \leq k$ and $j \leq k$. Then we have $V = \psi_{kj}^{-1}(\psi_{ki}(U))$. The hypothesis for this problem makes $\psi_{ki}(U)$ open in W_k , and then $\psi_{kj}^{-1}(\psi_{ki}(U))$ is open since ψ_{kj} is continuous.

For (b), we are to separate $q(x_i)$ and $q(x_j)$ by disjoint open sets if x_i and x_j are not equivalent. Choose k with $i \leq k$ and $j \leq k$, so that $\psi_{ki}(x_i)$ and $\psi_{kj}(x_j)$ are both in W_k . They are distinct in W_k by Problem 26b. Since W_k is Hausdorff, we can choose disjoint open sets A and B in W_k with $\psi_{ki}(x_i)$ in A and $\psi_{kj}(x_j)$ in B . Then $q(A)$ and $q(B)$ are disjoint since q is one-one on W_k , and they are open by (a).

For (c), the mapping into the direct limit is continuous and open and therefore carries compact neighborhoods to compact neighborhoods. Since the quotient map is onto the direct limit, every point of the direct limit has a compact neighborhood.

For an example in (d), take $W_i = \{1, \dots, i\}$ for each i , with ψ_{ji} equal to the inclusion if $i \leq j$. Each W_i is finite, hence compact, and the direct limit is the set of positive integers with the discrete topology.

30. Each $X(S)$ is Hausdorff as the product of Hausdorff spaces. The space $(\prod_{i \in S} K_i)$ is compact by the Tychonoff Product Theorem, and then $X(S)$ is the product of finitely many locally compact spaces, which is locally compact. The Hausdorff property is handled by Problem 29b, and the final assertion is clear from the definition.

Chapter V

1. If K is compact in U , then K is compact in V , and hence the inclusion of C_K^∞ into $C_{\text{com}}^\infty(V)$ is continuous. By Proposition 4.29 the inclusion of $C_{\text{com}}^\infty(U)$ into $C_{\text{com}}^\infty(V)$ is continuous.

2. Fix K compact large enough to contain $\text{support}(\varphi)$. Then the map $\psi \mapsto \psi\varphi$ is continuous from $C^\infty(U)$ into C_K^∞ . The inclusion of C_K^∞ into $C_{\text{com}}^\infty(U)$ is continuous, and hence $\psi \mapsto \psi\varphi$, being a composition of continuous functions, is continuous from $C^\infty(U)$ into $C_{\text{com}}^\infty(U)$.

3. Let $\{K_j\}$ be an exhausting sequence of compact subsets of U , and choose $\psi_j \in C_{\text{com}}^\infty(U)$ that is 1 on K_j and is 0 off K_{j+1} . For each j , the product $(\varphi|_U - \varphi_1)\psi_j$ is in $C_{\text{com}}^\infty(U)$ with support contained in the open set $U \cap (\text{support}(T_U))^\complement$. Therefore $T_U((\varphi|_U - \varphi_1)\psi_j) = 0$ for each j . The functions $(\varphi|_U - \varphi_1)\psi_j$ tend to $\varphi|_U - \varphi_1$ in the topology of $C^\infty(U)$, and therefore $T_U(\varphi|_U - \varphi_1) = 0$. Hence $T_U(\varphi|_U) = T_U(\varphi_1)$ as required.

4. An adjustment is needed to the proof of Theorem 5.1. The proof in the text in effect used the expressions $\|f\|_{K',\alpha} = \sup_{x \in K'} |(D^\alpha f)(x)|$ as seminorms together describing the relative topology of $C_{K'}^\infty$ as a subspace of $C^\infty(\mathbb{R}^n)$. To modify the proof of the theorem, we need to see that the same relative topology results from using the expressions $\|f\|_{K',\alpha,\text{new}} = \|(D^\alpha f)\|_{L^2(K')}$. In one direction we have $\|(D^\alpha f)\|_{L^2(K')} \leq C \sup_{x \in K'} |(D^\alpha f)(x)|$, the constant C being the L^2 norm of the function 1 on K' . In the reverse direction we apply Sobolev's inequality (Theorem 3.11) with U equal to the interior of K' . This open set satisfies the cone condition. Sobolev's inequality shows for $k > N/2$ that $\sup_{x \in K'} |(D^\alpha f)(x)| \leq C(\sum_{|\beta| \leq k} \|(D^{\alpha+\beta} f)\|_{L^2(K')})^{1/2}$. We follow the lines of the proof of Theorem 5.1, using these new seminorms and using linear functionals on spaces of L^2 functions instead of spaces of continuous functions, and the desired result follows.

5. For (a), we write $\langle T, \varphi \rangle = \sum_\alpha \int_{\mathbb{R}^N} D^\alpha \varphi d\rho_\alpha(x)$ by means of Theorem 5.1. Substitution and use of Lemma 5.6 gives

$$\begin{aligned} \langle T, F \rangle &= \sum_\alpha \int_{\mathbb{R}^N} D_x^\alpha \int_K \Phi(x, y) d\mu(y) d\rho_\alpha(x) \\ &= \sum_\alpha \int_{\mathbb{R}^N} \int_K D_x^\alpha \Phi(x, y) d\mu(y) d\rho_\alpha(x). \end{aligned}$$

On the other hand, $\int_K \langle T, \Phi(\cdot, y) \rangle d\mu(y) = \int_K \sum_\alpha \int_{\mathbb{R}^N} D_x^\alpha \Phi(x, y) d\rho_\alpha(x) d\mu(y)$, and the two expressions are equal by Fubini's Theorem.

For (b), choose a compact subset L of \mathbb{R}^N such that $L \times K$ contains $\text{support}(\Phi)$, and choose η in $C_{\text{com}}^\infty(\mathbb{R}^N)$ that is identically 1 on L . Part (a) shows that

$$\langle \eta S, F \rangle = \int_K \langle \eta S, \Phi(\cdot, y) \rangle d\mu(y).$$

On the other hand, we have $\langle \eta S, F \rangle = \langle S, \eta F \rangle = \langle S, F \rangle$, and $\langle \eta S, \Phi(\cdot, y) \rangle = \langle S, \eta(\cdot) \Phi(\cdot, y) \rangle = \langle S, \Phi(\cdot, y) \rangle$, and the result follows.

6. For any member η of $C_{\text{com}}^\infty(U)$ with values in $[0, 1]$, ηT is a member of $\mathcal{E}'(U)$. If φ is a real-valued member of $C_{\text{com}}^\infty(U)$, then for both choices of the sign \pm , $\eta(\|\varphi\|_{\text{sup}} \pm \varphi)$ is a member of $C_{\text{com}}^\infty(U)$ that is ≥ 0 . Hence $\langle T, \eta(\|\varphi\|_{\text{sup}} \pm \varphi) \rangle \geq 0$, and $\langle T, \eta \rangle \|\varphi\|_{\text{sup}} = \langle T, \eta \|\varphi\|_{\text{sup}} \rangle \geq \mp \langle T, \eta \varphi \rangle = \mp \langle \eta T, \varphi \rangle$, i.e., $|\langle \eta T, \varphi \rangle| \leq \langle T, \eta \rangle \|\varphi\|_{\text{sup}}$. For complex-valued φ , such an estimate is valid for the real and imaginary parts separately, and we conclude that $\varphi \mapsto \langle \eta T, \varphi \rangle$ is a bounded linear functional on $C_{\text{com}}^\infty(U)$ relative to the supremum norm. Corollary 3.6a shows that $C_{\text{com}}^\infty(U)$ is dense in $C_{\text{com}}(U)$ and that the approximating functions to a function ≥ 0 can be taken to be ≥ 0 . Consequently the continuous extension of ηT is a positive linear functional on $C_{\text{com}}(U)$. By the Riesz Representation Theorem the extension is given by a Borel measure μ_η . The boundedness of the linear functional forces $\mu_\eta(U)$ to be finite.

Let $\{K_p\}$ be an exhausting sequence. Define η_p to be a member of $C_{\text{com}}^\infty(U)$ with values in $[0, 1]$ that is 1 on K_{2p} and is 0 off K_{2p}^o , and write μ_p for the corresponding Borel measure μ_{η_p} . Then the sequence $\{\eta_p(x)\}$ is nondecreasing for each x and has limit 1. The measures μ_p have to be nondecreasing on each set, and we define $\mu(E) = \lim_p \mu_p(E)$ for each Borel set E . The nondecreasing limit of measures is a measure, with the complete additivity holding by monotone convergence. We show that $\langle T, \varphi \rangle = \int_U \varphi d\mu$ for every φ in $C_{\text{com}}^\infty(U)$.

For any φ in $C_{\text{com}}^\infty(U)$, as soon as p_0 is large enough so that K_{2p_0} contains $\text{support}(\varphi)$, we have $\langle \eta_p T, \varphi \rangle = \langle T, \varphi \rangle$ for $p \geq p_0$. Also, $\mu_p(E)$ remains constant for each Borel subset of K_{2p} when $p \geq p_0$, and hence $\mu(E) = \mu_p(E)$ for such subsets. Thus $\langle T, \varphi \rangle = \langle \eta_p T, \varphi \rangle = \int_U \varphi d\mu_p = \int_U \varphi d\mu$, as asserted.

7. Computation gives $\Delta(e^{-\pi|x|^2}) = 4\pi^2|x|^2 e^{-\pi|x|^2} - 2\pi N e^{-\pi|x|^2}$. What needs computing is $\int_{\mathbb{R}^N} |x|^{-(N-2)} |x|^{2p} e^{-\pi|x|^2} dx$ for $p = 1$ and $p = 0$, and then one has to sort out the result. This integral equals $\Omega_{N-1} \int_0^\infty r^{2p+1} e^{-\pi r^2} dr$. For $p = 1$ and $p = 0$, the integral is elementary. Alternatively, it can be converted into a value of the gamma function by the change of variables $\pi r^2 \mapsto s$. In neither case does the value of Ω_{N-1} need to be computed.

8. Part (a) follows from the chain rule and the boundedness of each derivative of η since $(\eta_\varepsilon)^{(k)}(x) = \varepsilon^{-k} \eta^{(k)}(\varepsilon^{-1}x)$.

For (b), if φ has compact support, then $(1 - \eta_\varepsilon)\varphi$ has compact support away from $\{0\}$. Therefore $\langle T, (1 - \eta_\varepsilon)\varphi \rangle = 0$, and $\langle T, \varphi \rangle = \langle T, (1 - \eta_\varepsilon)\varphi \rangle + \langle T, \eta_\varepsilon\varphi \rangle = \langle T, \eta_\varepsilon\varphi \rangle$. Since $\varphi \mapsto \langle T, \varphi \rangle$ and $\varphi \mapsto \langle T, \eta_\varepsilon\varphi \rangle$ are continuous and $C_{\text{com}}^\infty(\mathbb{R}^N)$ is dense in $C^\infty(\mathbb{R}^N)$, $\langle T, \varphi \rangle = \langle T, \eta_\varepsilon\varphi \rangle$ for all φ in $C^\infty(\mathbb{R}^N)$.

In (c), we apply (a) and obtain

$$\begin{aligned} |\langle T, \eta_\varepsilon \varphi \rangle| &\leq C \sum_{k=0}^n \sup_{|x| \leq M} |D^k(\eta_\varepsilon \varphi)(x)| = C \sum_{k=0}^n \sup_{|x| \leq \varepsilon} |D^k(\eta_\varepsilon \varphi)(x)| \\ &\leq C' \sum_{k=0}^n \sum_{l=0}^k \sup_{|x| \leq \varepsilon} |D^{k-l}(\eta_\varepsilon)(x)(D^l \varphi)(x)| \\ &\leq C'' \sum_{k=0}^n \sum_{l=0}^k \varepsilon^{l-k} \sup_{|x| \leq \varepsilon} |(D^l \varphi)(x)| \\ &\leq C''' \sum_{l=0}^n \varepsilon^{l-n} \sup_{|x| \leq \varepsilon} |(D^l \varphi)(x)|. \end{aligned}$$

When $\varphi(x) = \psi(x)x^{n+1}$, $|D^l \varphi(x)| \leq c \sum_{r=0}^l |D^{l-r} \psi(x)| |x^{n+1-r}|$, and the supremum for $|x| \leq \varepsilon$ is $\leq c' \varepsilon^{n+1-l}$. Therefore

$$|\langle T, \varphi \rangle| = |\langle T, \eta_\varepsilon \varphi \rangle| \leq c' C''' \sum_{l=0}^n \varepsilon^{l-n} \varepsilon^{n+1-l} = c' C''' (n+1) \varepsilon.$$

The right side tends to 0 as ε decreases to 0, and thus $\langle T, \varphi \rangle = 0$.

In (d), the Taylor expansion of a general φ is $\varphi(x) = \sum_{k=0}^n \frac{1}{k!} \varphi^{(k)}(0) x^k + \psi(x)x^{n+1}$ with ψ in $C^\infty(\mathbb{R}^1)$. Applying $\langle T, \cdot \rangle$ to both sides and using (c), we obtain $\langle T, \varphi \rangle = \sum_{k=0}^n \frac{1}{k!} \varphi^{(k)}(0) \langle T, x^k \rangle$.

9. The adjustments in the argument are to (a) and (c). For (a), the estimate is $|\langle D^\alpha \eta_\varepsilon(x) \rangle| \leq C_{|\alpha|} \varepsilon^{-|\alpha|}$ and is again proved by the chain rule. Each differentiation introduces a factor of ε^{-1} . For (c), Taylor's Theorem says that the remainder term in computing a smooth function $\varphi(x)$ about the point 0 is

$$\sum_{\substack{l_1 + \dots + l_N = n+1, \\ \text{all } l_j \geq 0}} \frac{n+1}{l_1! \dots l_N!} x_1^{l_1} \dots x_N^{l_N} \int_0^1 (1-s)^n \frac{\partial^{n+1} \varphi}{\partial x_1^{l_1} \dots \partial x_N^{l_N}}(sx) ds,$$

hence is of the form

$$\sum_{\substack{l_1 + \dots + l_N = n+1, \\ \text{all } l_j \geq 0}} \psi_{l_1, \dots, l_N}(x) x_1^{l_1} \dots x_N^{l_N}.$$

Thus one works with a function $\psi(x)x_1^{l_1} \dots x_N^{l_N}$ with ψ smooth and with $\sum_j l_j = n+1$. The argument for (c) in Problem 8 now can be used.

10. As with Problem 9, the arguments for (a) and (c) in Problem 8 need adjustment, and this time we need to change (d) completely. For (a), we use the above function η for \mathbb{R}^{N-L} , and we define $\eta_\varepsilon(x', x'') = \eta(\varepsilon^{-1}x'')$. Then (a) causes no difficulties. For (c), we need a new form of Taylor's Theorem. The point is to treat $\varphi(x', x'')$ as a function of x'' alone, form a Taylor expansion with remainder, and carry along x' as a parameter. The result is that the remainder term is a sum of terms of the form $\psi(x', x'')M(x'')$, where ψ is in $C^\infty(\mathbb{R}^N)$ and M is a homogeneous monomial in the x'' variables of total degree $n+1$. Then (c) causes no difficulties and again gives 0. In (d), the main terms of the Taylor expansion are of the form $c_\alpha D^\alpha \varphi(x', 0)(x'')^\alpha$, where α is a multi-index that is nonzero only in the positions corresponding to x'' and has total degree $\leq n$. We introduce a linear functional T_α on $C^\infty(\mathbb{R}^L)$ by the definition $\langle T_\alpha, \psi(x') \rangle = c_\alpha \langle T, \psi(x')(x'')^\alpha \rangle$. Then T_α is continuous, and the expansion $\langle T, \varphi \rangle = \sum_{|\alpha| \leq n} \langle T_\alpha, (D^\alpha \varphi)|_{\mathbb{R}^L} \rangle$ has the required form.

11. Subtracting two tempered distributions solving $\Delta u = f$, we obtain a tempered distribution u with $\Delta u = 0$. From $\mathcal{F}(D^\alpha u) = (2\pi i)^{|\alpha|} \xi^\alpha \mathcal{F}(u)$ and $\mathcal{F}(\Delta u) = 0$, we obtain $|\xi|^2 \mathcal{F}(u) = 0$. It follows that $\mathcal{F}(u)$ is supported at $\{0\}$. Problem 9 then shows that $\mathcal{F}(u)$ is a finite sum of the form $\sum_\alpha c_\alpha D^\alpha \delta$. Taking the inverse Fourier transform of both sides, we see that the distribution u equals a polynomial function.

12. Apply Theorem 5.1 to a member S of $\mathcal{E}'((-\pi, \pi)^N)$, writing it as a sum of finitely many derivatives of complex Borel measures ρ_α of compact support: $\langle S, \varphi \rangle = \sum_{|\alpha| \leq m} \int_K D^\alpha \varphi d\rho_\alpha$, where K is a compact subcube of $(-\pi, \pi)^N$. For $\varphi(x) = e^{-ik \cdot x}$, we have $\sup_{x \in K} |D^\alpha(e^{-ik \cdot x})| \leq |k^\alpha|$, and therefore $|\langle S, e^{-ik \cdot x} \rangle| \leq \sum_{|\alpha| \leq m} |k^\alpha| \|\rho_\alpha\| \leq C(1 + |k|^2)^{m/2}$, where $C = \sum_{|\alpha| \leq m} \|\rho_\alpha\|$.

13. Change notation and suppose that $|c_k| \leq C(1 + |k|^2)^m$ for all k . The series $f(x) = \sum_k \frac{c_k e^{ik \cdot x}}{(1 + |k|^2)^{m+N+1}}$ is then absolutely uniformly convergent, and $f(x)$ is continuous periodic. Define $S' \in \mathcal{E}'((-\pi, \pi)^N)$ by

$$\langle S', \varphi \rangle = (2\pi)^{-N} \int_{[-\pi, \pi]^N} f(x) \varphi(x) dx.$$

Let $\mathcal{D} = 1 - \Delta$, and define $S = \mathcal{D}^{m+N+1} S'$. Then

$$\begin{aligned} \langle S, e^{-ik \cdot x} \rangle &= \langle S', \mathcal{D}^{m+N+1}(e^{-ik \cdot x}) \rangle = (1 + |k|^2)^{m+N+1} \langle S', e^{-ik \cdot x} \rangle \\ &= (1 + |k|^2)^{m+N+1} (2\pi)^{-N} \int_{[-\pi, \pi]^N} f(x) e^{-ik \cdot x} dx \\ &= (1 + |k|^2)^{m+N+1} \frac{c_k}{(1 + |k|^2)^{m+N+1}} = c_k, \end{aligned}$$

as required.

14. For each φ , the set of ψ with $|B(\varphi, \psi)| \leq \|\varphi\|_{L_k^2(T^N)}$ is the set where the continuous function $|B(\varphi, \cdot)|$ is \leq some constant, and this is closed. The set $E_{k,M}$ is the intersection of such sets and is therefore closed. For each ψ , the function $B(\cdot, \psi)$ is linear and continuous, and therefore there exists an integer k and a constant M for which $|B(\varphi, \psi)| \leq M\|\varphi\|_{L_k^2(T^N)}$ for all φ . This proves (a).

Since $C^\infty(T^N)$ is complete, the Baire Category Theorem shows that some $E_{k,M}$ has nonempty interior, hence contains a basic open set, i.e., some set of the form $U = \{\psi' \mid \|\psi' - \psi_0\|_{L_s^2(T^N)} < \epsilon\}$. If ψ has $\|\psi\|_{L_s^2(T^N)} < \epsilon$, then $\psi_0 + \psi$ is in U and thus has $|B(\varphi, \psi_0 + \psi)| \leq M\|\varphi\|_{L_k^2(T^N)}$ for all φ in $C^\infty(T^N)$. Then

$$|B(\varphi, \psi)| \leq |B(\varphi, \psi_0 + \psi)| + |B(\varphi, \psi_0)| \leq M\|\varphi\|_{L_k^2(T^N)} + C_{\psi_0, k(\psi_0)} \|\varphi\|_{L_{k(\psi_0)}^2(T^N)}.$$

The right side is $\leq M'\|\varphi\|_{L_{k_1}^2(T^N)}$ for $k_1 = \max\{k, k(\psi_0)\}$ and $M' = M + C_{\psi_0, k(\psi_0)}$.

Hence $|B(\varphi, \psi)| \leq M'\epsilon^{-1} \|\varphi\|_{L_{k_1}^2(T^N)} \|\psi\|_{L_s^2(T^N)} \leq M'\epsilon^{-1} \|\varphi\|_{L_{k_2}^2(T^N)} \|\psi\|_{L_{k_2}^2(T^N)}$, where $k_2 = \max\{k_1, s\}$.

15. We apply the inequality of Problem 14b to $D^\alpha \varphi$ and $D^\beta \psi$, and then the result follows by applying the norm inequality of Problem 27 in Chapter III to $\|D^\alpha \varphi\|_{L_k^2(T^N)}$ and $\|D^\beta \psi\|_{L_k^2(T^N)}$.

16. The functions $e^{il \cdot x} e^{im \cdot y}$ are orthonormal in $L^2(T^N \times T^N)$, and it is therefore enough to show that the sum of the absolute-value squared of the coefficients is finite. That is, we are to show that

$$\sum_{l, m \in \mathbb{Z}^N} \frac{|b_{lm}|^2 l^{2\alpha} m^{2\beta}}{(\sum_{|\alpha'| \leq k'} l^{2\alpha'})^2 (\sum_{|\beta'| \leq k'} m^{2\beta'})^2} < \infty$$

whenever $|\alpha| \leq k'$ and $|\beta| \leq k'$. Since $l^{2\alpha} \leq \sum_{|\alpha'| \leq k'} l^{2\alpha'}$ and $m^{2\beta} \leq \sum_{|\beta'| \leq k'} m^{2\beta'}$, it is enough to prove that

$$\sum_{l, m \in \mathbb{Z}^N} \frac{|b_{lm}|^2}{(\sum_{|\alpha'| \leq k'} l^{2\alpha'}) (\sum_{|\beta'| \leq k'} m^{2\beta'})} < \infty. \quad (*)$$

If we use the estimate of Problem 15 for $\varphi = e^{il \cdot (\cdot)}$ and $\psi = e^{im \cdot (\cdot)}$, we have

$$l^{2\alpha} m^{2\beta} |b_{lm}|^2 = |B(D^\alpha e^{il \cdot (\cdot)}, D^\beta e^{im \cdot (\cdot)})|^2 \leq C^2 \|e^{il \cdot (\cdot)}\|_{L_k^2(T^N)}^2 \|e^{im \cdot (\cdot)}\|_{L_{k'}^2(T^N)}^2$$

for $|\alpha| \leq K$ and $|\beta| \leq K$. Hence

$$l^{2\alpha} m^{2\beta} |b_{lm}|^2 \leq C^2 \left(\sum_{|\alpha'| \leq k'} l^{2\alpha'} \right) \left(\sum_{|\beta'| \leq k'} m^{2\beta'} \right).$$

Summing over α and β for $|\alpha| \leq K$ and $|\beta| \leq K$ and taking into account Problem 29 in Chapter III, we obtain

$$(1 + |l|^2)^K (1 + |m|^2)^K |b_{lm}|^2 \leq C' \left(\sum_{|\alpha'| \leq k'} l^{2\alpha'} \right) \left(\sum_{|\beta'| \leq k'} m^{2\beta'} \right)$$

for a constant C' . Thus the left side of (*) is $\leq C' \sum_{l, m \in \mathbb{Z}^N} (1 + |l|^2)^{-K} (1 + |m|^2)^{-K}$, and Problem 32 of Chapter III shows that this is finite.

17. Since $F_{\alpha, \beta}$ is in $L^2(T^N \times T^N)$, B' is a continuous function of two $L^2(T^N)$ variables $D^\alpha \varphi$ and $D^\beta \psi$. In particular it is well defined for φ and ψ in $C^\infty(T^N)$. Because of continuity in L^2 and orthogonality, we have

$$\begin{aligned} (2\pi)^{-2N} \int_{[-\pi, \pi]^{2N}} F_{\alpha, \beta}(x, y) D^\alpha e^{il \cdot x} D^\beta e^{im \cdot y} dx dy \\ = (2\pi)^{-2N} \int_{[-\pi, \pi]^{2N}} \frac{b_{lm} (-i)^{|\alpha|+|\beta|} l^\alpha m^\beta i^{|\alpha|+|\beta|} l^\alpha m^\beta}{\left(\sum_{|\alpha'| \leq k'} l^{2\alpha'} \right) \left(\sum_{|\beta'| \leq k'} m^{2\beta'} \right)} dx dy \\ = \frac{b_{lm} l^{2\alpha} m^{2\beta}}{\left(\sum_{|\alpha'| \leq k'} l^{2\alpha'} \right) \left(\sum_{|\beta'| \leq k'} m^{2\beta'} \right)}. \end{aligned}$$

Summing for α and β with $|\alpha| \leq k'$ and $|\beta| \leq k'$, we obtain $B'(e^{il \cdot (\cdot)}, e^{im \cdot (\cdot)}) = B(e^{il \cdot (\cdot)}, e^{im \cdot (\cdot)})$.

18. The result of Problem 17 implies that $B'(\varphi, \psi) = B(\varphi, \psi)$ if φ and ψ are trigonometric polynomials. It shows also that convergence in L^2 of either variable and its derivatives through order k' implies convergence of B' . Since convergence in $C^\infty(T^N)$ implies convergence in $L^2_{k'}(T^N)$ and since B is separately continuous, $B' = B$ on $C^\infty(T^N)$. The expression on the right side of the display in the statement of Problem 17 is the action of a distribution on $T^N \times T^N$ upon the function $\varphi \otimes \psi$, and thus $B(\varphi, \psi) = \langle S, \varphi \otimes \psi \rangle$ for a suitable distribution S .

19. By the Schwarz inequality, $|B(f, g)| \leq \|H(\eta f)\|_2 \|\eta g\|_2 = \|\eta f\|_2 \|\eta g\|_2 \leq \|f\|_2 \|g\|_2 \leq \|f\|_{\text{sup}} \|g\|_{\text{sup}}$. This proves (a).

For (b), we argue by contradiction. Using continuous functions f and g with disjoint supports, we see near $(0, 0)$ that we must have $d\rho(x, y) = \frac{1}{\pi} \frac{dx dy}{x-y}$. However, the function $\frac{1}{x-y}$ is not locally integrable, and there can be no such signed measure ρ .

Chapter VI

1. For (a), let C be the connected component of 1. Since multiplication is continuous, it carries the connected set $C \times C$ to a connected set containing 1, hence to a subset of C . Thus C is closed under products. Similarly it is closed under inverses. It is topologically closed since the closure of a connected set is connected. If x is in G , then the map $x \mapsto gxg^{-1}$ is continuous and therefore carries the connected set C to a connected set containing 1, hence to a subset of C . Thus $gCg^{-1} \subseteq C$ for all g , and C is normal. For (b), one can take the additive rationals or the countable product of two-element groups; for each the identity component contains only the identity element.

2. In (a), if g fixes the first standard basis vector, then the first column of g is the first standard basis vector. Since g is a rotation, $g^{\text{tr}}g = 1$. In particular $\sum_j (g^{\text{tr}})_{ij} g_{j1} = \delta_{i1}$. Thus $(g^{\text{tr}})_{i1} = \delta_{i1}$ for all i , and $g_{1i} = \delta_{i1}$. In other words, the first row of g is 0 except in the first entry.

In (b), let v be any unit vector in \mathbb{R}^N , and extend v to a basis v, v_2, \dots, v_N . The Gram-Schmidt orthogonalization process replaces this basis by an orthonormal basis such that the first member is still v . We form a matrix with this orthonormal basis as its columns. If it has determinant -1 , we multiply the last column by -1 , and then the determinant will be 1. The resulting matrix is in $SO(N)$ and carries the first standard basis vector to v .

For (c), we obtain a continuous function $SO(N) \rightarrow S^{N-1}$ given by $g \mapsto ge_1$, where e_1 is the first standard basis vector. This function descends to a function $SO(N)/SO(N-1) \rightarrow S^{N-1}$ that is necessarily continuous. It is one-one onto, its domain is compact, and the image is Hausdorff. Hence it is a homeomorphism.

3. What needs to be shown is that every sufficiently small open neighborhood N of $1 \cdot H$ in G/H is mapped to an open set by π . Since G/H is locally compact

and has a countable base, there exist open neighborhoods U_k of $1 \cdot H$ such that U_k^{cl} is compact, $U_k^{\text{cl}} \subseteq U_{k+1}$, and $G/H = \bigcup_k U_k$. The Baire Category Theorem for X shows that $\pi(U_n)$ has nonempty interior V for some n . Let y be a member of G such that $\pi(yH)$ is in V , and put $U = \pi^{-1}(y^{-1}V)$. Then U is an open neighborhood of $1 \cdot H$ in G/H and $\pi(U) = y^{-1}V$ is open in X . Also, U^{cl} is compact as a closed subset of U_n^{cl} . Let N be any open neighborhood of $1 \cdot H$ in G/H that is contained in U . Since U^{cl} is compact, π is a homeomorphism from U^{cl} with the relative topology to $\pi(U^{\text{cl}})$ with the relative topology. Thus $\pi(N)$ is relatively open in $\pi(U^{\text{cl}})$. Hence $\pi(N) = \pi(U^{\text{cl}}) \cap W$ for some open set W in X . Since $\pi(N) \subseteq \pi(U)$, we can intersect both sides with $\pi(U)$ and get $\pi(N) = \pi(U^{\text{cl}}) \cap W \cap \pi(U) = W \cap \pi(U)$. Since $W \cap \pi(U)$ is open in X , $\pi(N)$ is open in X .

4. This is a special case of the previous problem.

5. No. The reason is that the subset $\mathbb{R}^1 p$ cannot be locally compact. In fact, if it were locally compact, then it would be open in its closure, by Problem 4 in Chapter X of *Basic*. Since T^2 is a group and $\mathbb{R}^1 p$ is a subgroup, $(\mathbb{R}^1 p)^{\text{cl}}$ is a group, and $\mathbb{R}^1 p$ would be an open dense subgroup. An open subgroup is closed, and hence $\mathbb{R}^1 p$ would be equal to $(\mathbb{R}^1 p)^{\text{cl}}$, i.e., $\mathbb{R}^1 p$ would have to be closed in T^2 . Then $\mathbb{R}^1 \cap \{(e^{i\theta}, 1)\}$ would be a closed subgroup of the circle group $\{(e^{i\theta}, 1)\}$ and would have to be a finite subgroup or the entire circle. On the other hand, we readily check that $\mathbb{R}^1 p \cap \{(e^{i\theta}, 1)\}$ is countably infinite. It therefore cannot be closed.

6. Take V to be any bounded open neighborhood of 1. Inductively for $n \geq 1$, choose g_n such that $g_n \notin \bigcup_{k=1}^{n-1} g_k V$. Then choose an open neighborhood U of 1 with $U = U^{-1}$ and $UU \subseteq V$. Let us see that $g_k U \cap g_n U = \emptyset$ if $k < n$. If g is in $g_k U \cap g_n U$, then $g_k u = g_n u'$ with u and u' in U , and hence g_n is in $g_k U U^{-1} \subseteq g_k V$. This contradicts the defining property of g_n . Thus the sets $g_n U$ are disjoint. The left Haar measure of their union therefore equals the sum of their left Haar measures, and their left Haar measures are equal to some positive number, U being a nonempty open set. Consequently the left Haar measure of G is infinite.

7. For (a), we have

$$\begin{aligned} \lambda(E)\rho(G) &= \int_G \int_G I_E(y) d\lambda(y) d\rho(x) = \int_G \int_G I_E(xy) d\lambda(y) d\rho(x) \\ &= \int_G \int_G I_E(xy) d\rho(x) d\lambda(y) = \int_G \int_G I_E(x) d\rho(x) d\lambda(y) \\ &= \lambda(G)\rho(E). \end{aligned}$$

Therefore $\lambda(E)\rho(G) = \lambda(G)\rho(E)$ as asserted.

For (b), let λ_1 and λ_2 be two left Haar measures. Without loss of generality, we may assume that $\lambda_1(G) = \lambda_2(G) = 1$. Let ρ be a right Haar measure (existence by Theorem 12.1). Applying (a) twice, we obtain $\lambda_1(E)\rho(G) = \lambda_1(G)\rho(E) = \rho(E) = \lambda_2(G)\rho(E) = \lambda_2(E)\rho(G)$, and hence $\lambda_1(E) = \lambda_2(E)$ on Baire sets. Consequently $\lambda_1 = \lambda_2$ as regular Borel measures.

8. In (a), both are Haar measures on $G^{(n)}$ of total measure one. Parts (b) and (c) are special cases of Problems 15–19 of Chapter XI of *Basic*.

9. For fixed g in G , we have $d_l(\Phi(gx)) = d_l(\Phi(g)\Phi(x)) = d_l(\Phi(x))$, and hence $d_l(\Phi(\cdot))$ and $d_l(\cdot)$ are left Haar measures on G . The uniqueness in Theorem 6.8 shows that they are multiples of one another.

10. Under left translation we have $(s_0, t_0)(s, t) = (s_0s)((s^{-1}t_0s)t)$. If φ is left translation by (s_0, t_0) , then $(ds dt)_{\varphi^{-1}} = d(s_0s) d((s^{-1}t_0s)t) = ds dt$, and $ds dt$ is a left Haar measure. Under right translation we have $(s, t)(s_0, t_0) = (ss_0)((s_0^{-1}ts_0)t_0)$. Thus $ds dt$ goes to $d(ss_0) d((s_0^{-1}ts_0)t_0) = ds d(s_0^{-1}ts_0) = \delta(s_0^{-1}) ds dt$, and $\delta(s) ds dt$ goes to $\delta(ss_0)\delta(s_0^{-1}) ds dt = \delta(s) ds dt$. In other words, $\delta(s) ds dt$ is a right Haar measure.

11. In (a), we have $\int_V f(c^{-1}x) dx = \int_V f(x) d(cx) = |c|_V \int_V f(x) dx$ for f in $C_{\text{com}}(V)$. Hence $|c_1c_2|_V \int_V f(x) dx = \int_V f((c_1c_2)^{-1}x) dx = \int_V f(c_2^{-1}x) d(c_1x) = |c_1|_V \int_V f(c_2^{-1}x) dx = |c_1|_V |c_2|_V \int_V f(x) dx$. Choosing f with $\int_V f(x) dx \neq 0$, we obtain $|c_1c_2|_V = |c_1|_V |c_2|_V$ when $c_1 \neq 0$ and $c_2 \neq 0$. The equality is trivial when one or both of c_1 and c_2 are 0, and hence we have $|c_1c_2|_V = |c_1|_V |c_2|_V$ in all cases.

To prove continuity, we first check continuity at each $c_0 \neq 0$. Let $S = \text{support}(f)$, and let N be a compact neighborhood of c_0 not containing 0. If c is in N , then $f(c^{-1}x)$ is nonzero only for x in the compact set NS . Let $\epsilon > 0$ be given. Continuity of $(c, x) \mapsto f(c^{-1}x)$ allows us to find, for each x in NS , an open subneighborhood N_x of c_0 and an open neighborhood U_x of x such that $|f(c^{-1}y) - f(c_0^{-1}x)| < \epsilon$ for $c \in N_x$ and $y \in U_x$. Then $|f(c^{-1}y) - f(c_0^{-1}y)| < 2\epsilon$ for $c \in N_x$ and $y \in U_x$. The open sets U_x cover NS . Forming a finite subcover and intersecting the corresponding finitely many sets N_x , we obtain an open neighborhood N' of c_0 such that $|f(c^{-1}y) - f(c_0^{-1}y)| < 2\epsilon$ for $c \in N'$ whenever y is in NS . As a result, $c \mapsto \int_V f(c^{-1}x) dx$ is continuous at $c = c_0$. Therefore $c \mapsto |c|_V \int_V f(x) dx$ is continuous at c_0 , and so is $c \mapsto |c|_V$.

To prove continuity at $c = 0$, we are to show that $\lim_{c \rightarrow 0} \int_V f(c^{-1}x) dx = 0$. Let U be any compact neighborhood of 0 in V . Find a sufficiently small neighborhood N of 0 in V such that $c \in N$ implies that $c \text{ support}(f)$ does not meet U^c . Then $c^{-1}U^c \cap \text{support}(f) = \emptyset$. For such c 's, we have $|\int_V f(c^{-1}x) dx| = |\int_U f(c^{-1}x) dx| \leq \|f\|_{\text{sup}}(dx(U))$. The desired limit relation follows.

Finally, even without the continuity at $c = 0$, these properties imply that $|c|_V = |c|^t$ for some real t . The continuity at $c = 0$ forces $t \geq 0$. Then it follows that $|c_1|_V \leq |c_2|_V$ if $|c_1| \leq |c_2|$.

In (b), V/W is itself a locally compact topological vector space, and its group operation is addition. With the normalization of Haar measures as in Theorem 6.18, μ becomes a Haar measure on V/W , and we write it as $d(v+W)$. Then $\int_V f(v) dv = \int_{V/W} (\int_W f(v+w) dw) d(v+W)$. If we replace f by $f(c^{-1}\cdot)$ and move the c into the measures, we obtain $\int_V f(v) d(cv) = \int_{V/W} (\int_W f(v+w) d(cw)) d(c(v+W))$ and therefore $|c|_V \int_V f(v) dv = |c|_{V/W} \int_{V/W} (|c|_W \int_W f(v+w) dw) d(v+W)$. Hence $|c|_V = |c|_{V/W} |c|_W$.

In (c), choose N such that $|2|_V < 2^N$. If V has an N -dimensional subspace W , then Proposition 4.5 and Corollary 4.6 show that this subspace is closed and is Euclidean. Therefore $|2|_W = 2^N$. Then (b) shows that $|2|_{V/W} = |2|_V/|2|_W = 2^{-N}|2|_V < 1$. But this conclusion contradicts the fact that $|c|_{V/W} \geq 1$ if $|c| \geq 1$. We conclude that $\dim V < N$.

12. By inspection, $(\ell_{v_1}, \ell_{v_2}) = (v_2, v_1)$ has the properties of an inner product. The Banach-space norm of ℓ_v is $\sup_{\|v'\| \leq 1} |\ell_v(v')| = \sup_{\|v'\| \leq 1} |(v', v)|$. This is $\leq \|v\| = \|\ell_v\|$ by the Schwarz inequality, and it is $\geq \|v\| = \|\ell_v\|$ because we can choose $v' = v/\|v\|$.

The contragredient has $(\Phi^c(x)\ell_v)(v') = \ell_v(\Phi(x^{-1})v') = (\Phi(x^{-1})v', v) = (v', \Phi(x)v) = \ell_{\Phi(x)v}(v')$. Hence $\Phi^c(x)\ell_v = \ell_{\Phi(x)v}$, and $(\Phi^c(x)\ell_v, \Phi^c(x)\ell'_v) = (\Phi(x)v', \Phi(x)v) = (v', v) = (\ell_v, \ell'_v)$.

13. Taking the adjoint of $E\Phi(g) = \Phi'(g)E$ gives $\Phi(g)^*E^* = E^*\Phi'(g)^*$ for all g . Since Φ is unitary, $\Phi(g)^{-1}E^* = E^*\Phi'(g)^{-1}$ for all g , and thus $\Phi(g)E^* = E^*\Phi'(g)$. Then $E^*E\Phi(g) = E^*\Phi'(g)E = \Phi(g)E^*E$. By Schur's Lemma, E^*E is scalar, say equal to cI . Since E is invertible, c is not zero. If $v \neq 0$, then $c\|v\|^2 = (cI(v), v) = (E^*E(v), v) = (E(v), E(v)) \geq 0$. So $c > 0$. If \sqrt{c} denotes the positive square root of c , then $F = (\sqrt{c})^{-1}E$ exhibits Φ and Φ' as equivalent, and F is unitary because $F^*F = (\sqrt{c})^{-2}E^*E = c^{-1}cI = I$.

14. The operator $\Phi(\rho)$, for ρ in $O(N)$, makes sense on all of $L^2(\mathbb{R}^N)$, as well as on the vector space H_k . It was observed in the example toward the end of Section 8 that the Fourier transform \mathcal{F} commutes with the action by members of $O(N)$. Thus we have $\mathcal{F}(\Phi(\rho)(h_j(x)f(|x|))) = \Phi(\rho)\mathcal{F}(h_j(x)f(|x|))$. The left side at y equals the expression $\sum_i \Phi(\rho)_{ij}\mathcal{F}(h_i(x)f(|x|))(y) = \sum_i \Phi(\rho)_{ij} \sum_s h_s(y)f_{si}(|y|) = \sum_s (\sum_i \Phi(\rho)_{ij}f_{si}(|y|))h_s(y)$, and the right side is $\Phi(\rho)(\sum_t h_t(y)f_{ti}(|y|)) = \sum_t \sum_s \Phi(\rho)_{st}h_s(y)f_{ti}(|y|) = \sum_s (\sum_t \Phi(\rho)_{st}f_{ti}(|y|))h_s(y)$. The equality of the two sides gives us, for each $|y|$, the matrix equality asserted in (a).

Corollary 6.27, the formula of part (a), and the irreducibility of H_k together imply that $F(|y|)$ is a scalar matrix for each $|y|$. In other words, $f_{ij}(|y|) = g(|y|)\delta_{ij}$ for some scalar-valued function g . Then $\mathcal{F}(h_j(x)f(|x|))(y) = \sum_i h_i(y)f_{ij}(|y|) = \sum_i h_i(y)g(|y|)\delta_{ij} = h_j(y)g(|y|)$ for all j . Since h is a linear combination of the h_j 's, $\mathcal{F}(h(x)f(|x|))(y) = h(y)g(|y|)$. This proves (b).

For (c), we observe that $F(|y|)$ is continuous if $f(|x|)$ is continuous of compact support. In fact, the inner product on H_k can be taken to be integration with $d\omega$ over the unit sphere S^{N-1} . By homogeneity this is the same as the inner product relative to $r^{-2k}d\omega$ over the sphere of radius r centered at 0. Then the formula for f_{ij} is

$$\begin{aligned} f_{ij}(r) &= \int_{S^{N-1}} \mathcal{F}(h_j(x)f(|x|))(r\omega)\overline{h_i(r\omega)}r^{-2k}d\omega \\ &= \int_{S^{N-1}} \mathcal{F}(h_j(x)f(|x|))(r\omega)\overline{h_i(\omega)}r^{-k}d\omega \end{aligned}$$

for $r > 0$, and this is continuous in r since $\mathcal{F}(h_j(x)f(|x|))$ is continuous on \mathbb{R}^N . Thus the vector subspace of all f in $L^2((0, \infty), r^{N-1+2k}dr)$ for which $\mathcal{F}(h(x)f(|x|))$

is of the form $h(y)g(|y|)$ contains the dense subspace $C_{\text{com}}((0, \infty))$. Let $f^{(n)}$ in $C_{\text{com}}((0, \infty))$ tend to f in $L^2((0, \infty), r^{N-1+2k} dr)$. Then $h(x)f^{(n)}(|x|)$ tends to $h(x)f(|x|)$ in $L^2(\mathbb{R}^N)$, and $\mathcal{F}(h(x)f^{(n)}(|x|))$ tends to $\mathcal{F}(h(x)f(|x|))$ in norm. A subsequence therefore converges almost everywhere. Since $\mathcal{F}(h(x)f^{(n)}(|x|))(y) = h(y)g^{(n)}(|y|)$ almost everywhere, the limit function must be of the form $h(y)g(|y|)$ almost everywhere.

15. If $\{v_j\}$ is an orthonormal basis of V , then $\{\ell_{v_j}\}$ is an orthonormal basis of V^* , and $(\Phi^c(x)\ell_{v_j}, \ell_{v_j}) = (\ell_{\Phi(x)v_j}, \ell_{v_j}) = (v_j, \Phi(x)v_j) = \overline{(\Phi(x)v_j, v_j)}$. Summing on j gives the desired equality of group characters.

16. Following the notation of that example, let $\tau_{ij}(x) = (\tau(x)u_j, u_i)$, let l be the left-regular representation, and let ℓ_v be as in Problem 12. Consider, for fixed j_0 , the image of $\tau^c(g)\ell_{u_i}$ under the linear extension of the map $E'(\ell_{u_k})(x) = (\tau(x)u_{j_0}, u_k)$. This is $E'(\ell_{\sum_k c_k u_k})(x) = E'(\sum_k \bar{c}_k \ell_{u_k})(x) = \sum_k \bar{c}_k E'(\ell_{u_k})(x) = \sum_k \bar{c}_k (\tau(x)u_{j_0}, u_k) = (\tau(x)u_{j_0}, \sum_k c_k u_k)$, and hence $E'(\ell_v)(x) = (\tau(x)u_{j_0}, v)$. Then the image of interest is

$$\begin{aligned} E'(\tau^c(g)\ell_{u_i})(x) &= E'(\ell_{\tau(g)u_i})(x) = (\tau(x)u_{j_0}, \tau(g)u_i) \\ &= (\tau(g^{-1}x)u_{j_0}, u_i) = (l(g)\tau_{ij_0})(x). \end{aligned}$$

Hence l carries a column of matrix coefficients to itself and is equivalent on such a column to τ^c .

17. In (a), the left-regular representation on $G = \mathbb{R}/2\pi\mathbb{Z}$ is given by $(l(\theta)f)(e^{i\varphi}) = f(e^{i(\varphi-\theta)})$. Assuming on the contrary that l is continuous in the operator norm topology, choose $\delta > 0$ such that $|\theta| < \delta$ implies $\|l(\theta) - 1\| < 1$. Since $\|e^{in\varphi}\|_2 = 1$, we must have $\|l(\theta)(e^{in\varphi}) - e^{in\varphi}\|_2 < 1$ for $|\theta| < \delta$. Then

$$|e^{-in\theta} - 1|^2 = \frac{1}{2\pi} \int_{-\pi}^{\pi} |e^{-in\theta} - 1|^2 d\varphi = \frac{1}{2\pi} \int_{-\pi}^{\pi} |e^{in(\varphi-\theta)} - e^{in\varphi}|^2 d\varphi < 1$$

for all θ with $|\theta| < \delta$ and for all n . For large N , $\theta = \frac{\pi}{2N}$ satisfies the condition on θ , and $n = N$ has $|e^{-in\theta} - 1|^2 = |-i - 1|^2 = 2$, contradiction.

In (b), $\|\Phi(g)v - v\|^2 = (\Phi(g)v - v, \Phi(g)v - v) = \|\Phi(g)\|^2 - 2\text{Re}(\Phi(g)v, v) + \|v\|^2 = 2\|v\|^2 - 2\text{Re}(\Phi(g)v, v)$. The weak continuity shows that the right side tends to 0 as g tends to 1, and hence the left side tends to 0, i.e., Φ is strongly continuous.

18. In (a), we apply Problem 15. Let $\{u_i\}$ be an orthonormal basis of the space of Φ . In the formula $(\Phi(f)u_k, u_k) = \int_G (\Phi(x)u_k, u_k) f(x) dx$, we take f to be of the form $f(x) = \overline{(\Phi(x)u_j, u_i)}$. Substituting and using Schur orthogonality gives $(\Phi(f)u_k, u_k) = d^{-1}(u_k, u_j)\overline{(u_k, u_i)}$. Summing on k shows that $\text{Tr } \Phi(f) = d^{-1}\delta_{ij}$, and the right side is $d^{-1}f(1)$ for this f . Thus $f(1) = d\Phi(f)$. Passing to a linear combination of such f 's, we obtain the asserted formula.

Part (b) follows by taking linear combinations of results from (a), and part (c) follows by applying (b) to a function $f^* * f$, where $f^*(x) = \overline{f(x^{-1})}$. Part (d) follows by decomposing the right-regular representation on $L^2(G)$ into irreducible representations and using the identification in Section 8 of the isotypic subspaces.

19. For (a), $h * f(x) = \int_G h(xy^{-1})f(y) dy = \int_G h(y^{-1}x)f(y) dy = f * h(x)$.

For (b), it is enough to check the assertion for f equal to a matrix coefficient $x \mapsto (\Phi(x)u_j, u_i) = \Phi_{ij}(x)$ of an irreducible unitary representation Φ . If Φ has degree d , then we have

$$\begin{aligned} \int_G f(gxg^{-1}) dg &= \int_G \Phi_{ij}(gxg^{-1}) dg = \sum_{k,l} \int_G \Phi_{ik}(g)\Phi_{kl}(x)\Phi_{lj}(g^{-1}) dg \\ &= \sum_{k,l} \Phi_{kl}(x) \int_G \Phi_{ik}(g)\overline{\Phi_{jl}(g)} dg = \sum_{k,l} \Phi_{kl}(x)d^{-1}\delta_{ij}\delta_{kl} = \delta_{ij}d^{-1} \sum_k \Phi_{kk}(x), \end{aligned}$$

as required.

In (c), Corollary 6.33 shows that h is the uniform limit of a net of trigonometric polynomials. Since $C(G)$ is metrizable, h is the uniform limit of a sequence of trigonometric polynomials h_n . If $\epsilon > 0$ is given, we can find N such that $n \geq N$ implies $|h_n(y) - h(y)| \leq \epsilon$ for all y . Then $|h_n(gxg^{-1}) - h(gxg^{-1})| \leq \epsilon$ and so $|\int_G h_n(gxg^{-1}) dg - \int_G h(gxg^{-1}) dg| \leq \epsilon$. The function $H_n(x) = \int_G h_n(gxg^{-1}) dg$ is a linear combination of irreducible characters by (b), and $\int_G h(gxg^{-1}) dg$ is just h . Thus h is the uniform limit of the sequence of functions H_n , each of which is a linear combination of characters.

In (d), it is enough to prove that the space of linear combinations of irreducible characters is dense in the vector subspace of L^2 in question. If h is in this subspace, choose a sequence of functions h_n in $C(G)$ converging to h in L^2 . Then $H_n(x) = \int_G h_n(gxg^{-1}) dg$ converges to h in L^2 , and each H_n is continuous and has the invariance property that $H_n(gxg^{-1}) = H_n(x)$. Hence the vector subspace of members of $C(G)$ with this invariance property is L^2 dense in the subspace of L^2 in question. By (c), any member of $C(G)$ with the invariance property is the uniform limit of a sequence of functions, each of which is a finite linear combination of characters. Since uniform convergence implies L^2 convergence on a space of finite measure, the space of linear combinations of irreducible characters is L^2 dense in the space in question.

20. In (a), the sum $\sum_{\alpha} (d^{(\alpha)})^2$ counts the number of elements in the basis of $L^2(G)$ in Corollary 6.32. Another basis consists of the indicator functions of one-element subsets of G , and the two bases must have the same number of elements.

In (b), again we have two ways of computing a dimension, one from (d) in the previous problem, and the other from indicator functions of single conjugacy classes. The two computations must give the same result.

In (c), representatives of the possible cycle structures are (1234), (123), (12), (12)(34), (1). By (b), the number of $\Phi^{(\alpha)}$'s is 5. Two of these have degree 1. For the other three the sums of the squares of the degrees must equal $24 - 1 - 1 = 22$. The only possibility is $22 = 9 + 9 + 4$, and thus the degrees are 1, 1, 2, 3, 3.

21. Let $\Omega \subseteq G$ be the set of products ST , and let $K = S \cap T$. The group $S \times T$ acts continuously on Ω by $(s, t)\omega = s\omega t^{-1}$, and the isotropy subgroup at 1 is the closed subgroup $\text{diag } K$. Thus the map $(s, t) \mapsto st^{-1}$ descends to a map of $(S \times T)/\text{diag } K$ onto Ω . Since Ω is assumed open in G , it is locally compact Hausdorff in the relative

topology. Then Problem 3 shows that the map of $(S \times T)/\text{diag } K$ onto Ω is open, and it follows by taking compositions that the multiplication map of $S \times T$ to Ω is open.

22. In the two parts, AN and MAN are subgroups closed under limits of sequences, hence are closed subgroups. Consider the decompositions in (a) and (b). For the decomposition in (a), we multiply out the relation $k_\theta a_x n_y = \begin{pmatrix} a & b \\ c & d \end{pmatrix}$ and solve for θ , x , and y , obtaining

$$e^x = \sqrt{a^2 + c^2}, \quad \cos \theta = e^{-x} a, \quad \sin \theta = e^{-x} c, \quad y = e^{-2x}(ab + cd).$$

Hence we have the required unique decomposition. Since KAN equals all of G , the image under multiplication of $K \times AN$ is open in G . For the decomposition in (b), we multiply out the relation $v_t m_\pm a_x n_y = \begin{pmatrix} a & b \\ c & d \end{pmatrix}$ and solve for t , m_\pm , x , and y , obtaining

$$\pm = \text{sgn } a, \quad e^x = |a|, \quad y = b/a, \quad t = c/a.$$

Hence we have the required unique decomposition if $a \neq 0$, and the decomposition fails if $a = 0$. Since $VMAN$ equals the open subset of G where the upper left entry is nonzero, the image under multiplication of $V \times MAN$ is open in G .

The group $G = SL(2, \mathbb{R})$ is unimodular, being generated by commutators, and hence the formula in Theorem 12.9 simplifies to $\int_G f(x) dx = \int_{S \times T} f(st) d_t s d_r t$. For (a), we apply this formula with $S = K$ and $T = AN$. The group K is unimodular, so that $d_t s$ becomes $d\theta$, and we easily compute that $d_r t$ can be taken to be $e^{2x} dy dx$. For (b), we apply the formula with $S = V$ and $T = MAN$. The group V is unimodular, and we find that the right Haar measure for MAN can be taken to be $e^{2x} dy dx$ on the m_+ part and the same thing on the m_- part.

25. If h is in $C([0, \pi])$, the previous two problems produce a unique $f = f_h$ in $C(G)$ such that f_h is constant on conjugacy classes and has $h(\theta) = f_h(t_\theta)$. Define $\ell(h) = \int_G f_h(x) dx$. This is a positive linear functional on $C([0, \pi])$ and yields the measure μ , by the Riesz Representation Theorem. If f is any member of $C(G)$ and $f_0(x) = \int_G f(gxg^{-1}) dg$, then $\int_G f(x) dx = \int_G f_0(x) dx$ and f_0 is f_h for the function $h(\theta) = f_0(t_\theta)$. The construction of μ makes $\int_{[0, \pi]} f_0(t_\theta) d\mu = \int_G f_0(x) dx$. Substitution gives $\int_{[0, \pi]} [\int_G f(gt_\theta g^{-1}) dg] d\mu = \int_G f_0(x) dx = \int_G f(x) dx$.

26. The crux of the matter is (a). The formula of Problem 25, together with the character formula for χ_n , gives

$$\delta_{n0} = \int_G \chi_n \overline{\chi_0} dx = \int_{[0, \pi]} (e^{in\theta} + e^{i(n-2)\theta} + \dots + e^{-in\theta}) d\mu(\theta).$$

This says that $\int_{[0, \pi]} d\mu(\theta) = 1$ for $n = 0$, $\int_{[0, \pi]} (e^{i\theta} + e^{-i\theta}) d\mu(\theta) = 0$ for $n = 1$, and $\int_{[0, \pi]} (e^{2i\theta} + 1 + e^{-2i\theta}) d\mu(\theta) = 0$ for $n = 2$. The middle term of the integrand for $n = 2$ has already been shown to produce 1, and thus the $n = 2$ result may be

rewritten as $\int_{[0,\pi]} (e^{2i\theta} + e^{-2i\theta}) d\mu(\theta) = -1$. For $n \geq 3$, comparison of the displayed formula for n with what it is for $n - 2$ gives $0 = \int_{[0,\pi]} (e^{in\theta} + e^{-in\theta}) d\mu(\theta) + \delta_{n-2,0}$. Since $n - 2 > 0$, we obtain $\int_{[0,\pi]} (e^{in\theta} + e^{-in\theta}) d\mu(\theta) = 0$ for $n > 2$.

For the rest we replace θ by $-\theta$ in our integrals and see that the integral $\int_{[-\pi,0]} (e^{in\theta} + e^{-in\theta}) d\mu(-\theta)$ is 0 for $n = 1$ and $n \geq 3$, and is -1 for $n = 2$. Therefore $\int_{[-\pi,\pi]} (e^{in\theta} + e^{-in\theta}) d\mu'(\theta)$ is 0 for $n = 1$ and $n \geq 3$, and is -1 for $n = 2$. We can regard μ' as a periodic Stieltjes measure whose Fourier series may be written in terms of cosines and sines. Since $\mu'(E) = \mu'(-E)$, only the cosine terms contribute. There are no point masses since only finitely many Fourier coefficients are nonzero. Since $\cos 2\theta$ has a cosine series with no other $\cos k\theta$ contributing, $\int_{[-\pi,\pi]} \cos n\theta d\mu'(\theta) = -\frac{1}{2}\delta_{n,2} = -\frac{1}{2\pi} \int_{[-\pi,\pi]} \cos n\theta \cos 2\theta d\theta$ for all $n > 0$. Taking into account that $\mu'([- \pi, \pi]) = 1$, we conclude from the Fourier coefficients that $d\mu'(\theta) = \frac{1}{2\pi}(1 - \cos 2\theta) d\theta = \frac{1}{\pi} \sin^2 \theta d\theta$. Since $\int_G f(x) dx = \int_{[-\pi,\pi]} \int_G f(gt\theta g^{-1}) dg d\mu'(\theta)$, substitution into the formula of Problem 25 gives the desired result.

27. Problem 19d shows that the irreducible characters give an orthonormal basis for the subspace of L^2 functions on $SU(2)$ invariant under conjugation. In view of Problem 26d, the restrictions of these characters to the diagonal subgroup T therefore form an orthonormal basis of the subspace of all functions χ in $L^2([- \pi, \pi], \frac{1}{\pi} \sin^2 \theta d\theta)$ with $\chi(\theta) = \chi(-\theta)$. Since $\sin^2 \theta = \frac{1}{4}|e^{i\theta} - e^{-i\theta}|^2$, the conditions to have a new χ are that it be a continuous function with $\chi(\theta) = \chi(-\theta)$ such that

$$\int_{-\pi}^{\pi} (e^{i\theta} - e^{-i\theta}) \chi(\theta) (e^{i(n+1)\theta} - e^{-i(n+1)\theta}) d\theta = 0$$

for every integer $n \geq 0$. Using the condition $\chi(\theta) = \chi(-\theta)$, we can write the Fourier series of χ as $\chi(\theta) \sim \frac{a_0}{2} + \sum_{k=1}^{\infty} a_k \cos k\theta$. For $n \geq 1$, the orthogonality condition says that $\int_{-\pi}^{\pi} \chi(\theta) (\cos(n+2)\theta - \cos n\theta) d\theta = 0$. Hence $a_{n+2} = a_n$ for $n \geq 1$. By the Riemann–Lebesgue Lemma, all a_n are 0 for $n \geq 1$. Thus χ is constant. Since $\chi_0 = 1$ is already a known character, $\chi = 0$.

28. Let F be a compact topological field. If F is discrete, then each one-point set is open, and the compactness forces F to be finite. Otherwise, every point in F is a limit point. Take a net $\{x_\alpha\}$ in $F - \{0\}$ with limit 0, and form the net $\{x_\alpha^{-1}\}$. By compactness this has a convergent subnet $\{x_{\alpha_\mu}^{-1}\}$ with some limit x_0 . By continuity of multiplication, $\{x_{\alpha_\mu}^{-1} x_{\alpha_\mu}\}$ converges to $0x_0 = 0$. On the other hand, every term of the subnet is 1, and we conclude that a net that is constantly 1 is converging to 0. This behavior means that F is not Hausdorff, contradiction.

29. In (a), the argument that $c \mapsto |c|_F$ is continuous and satisfies $|c_1 c_2|_F = |c_1|_F |c_2|_F$ is the same as in Problem 11a.

For (b), we have $d(cx)/|cx|_F = (|c|_F dx)/(|c|_F |x|_F) = dx/|x|_F$. For (c), $|x|_F = |x|$ if $F = \mathbb{R}$, and $|x|_F = |x|^2$ if $F = \mathbb{C}$. For (d), $|x|_F = |x|_p$ if $F = \mathbb{Q}_p$. For (e), we have $I = p\mathbb{Z}_p$, and therefore the Haar measure of I is the product of $|p|_p = p^{-1}$ times the Haar measure of \mathbb{Z}_p . Hence the Haar measure of I is p^{-1} .

30. In (a), the image of a multiplicative character must be a subgroup of S^1 , and the only subgroup of S^1 contained within a neighborhood of radius 1 about the identity is $\{1\}$. Thus as soon as n is large enough so that $p^n\mathbb{Z}_p$ is mapped into the unit “ball” about 1, $p_n\mathbb{Z}_p$ is mapped to 1.

In (b), $\mathbb{Q}_p/\mathbb{Z}_p$ is discrete since \mathbb{Z}_p is open. Hence the cosets of the members of \mathbb{Q} exhaust $\mathbb{Q}_p/\mathbb{Z}_p$, and it is enough to define a multiplicative character of the additive group \mathbb{Q} that is 1 on every member of $\mathbb{Q} \cap \mathbb{Z}_p$. Let a/b be in lowest terms with $b > 0$ and with $|a/b|_p = p^k$. If $k \leq 0$, then set $\varphi_0(a/b) = 1$. If $k \geq 0$, write $b = b'p^k$. Since b' and p^k are relatively prime, we can choose integers c and d with $cp^k + b'd = a$, and then $\frac{a}{b'p^k} = \frac{c}{b'} + \frac{d}{p^k}$. We set $\varphi_0(a/b) = e^{2\pi id/p^k}$. The result is well defined because if $c'p^k + b'd' = a$, then $(c - c')p^k + (d - d')b' = 0$ shows that $d - d'$ is divisible by p^k and hence that $e^{2\pi id/p^k} = e^{2\pi id'/p^k}$. One has to check that φ_0 has the required properties.

In (c), we may assume that φ is not trivial. The p -adic number k can be formed by an inductive construction. Use (a) to choose the smallest possible (i.e., most negative) integer n such that φ is trivial on $p^n\mathbb{Z}_p$. Then $x \mapsto \varphi(p^n x)$ is trivial on \mathbb{Z}_p and must be a power of $e^{2\pi i/p}$ on p^{-1} . We match this, adjust φ , iterate the construction through powers of p^{-1} , and prove convergence of the series obtained for k .

31. Write r in \mathbb{Q} as $r = \pm m/n$, assume without loss of generality that $r \neq 0$, and factor m and n as products of powers of primes. Only finitely many primes can appear, and $|r|_p = 1$ if p is prime but is not one of those primes. The only other v is ∞ , and thus $|r|_v = 1$ except for finitely many v .

32. With $r \neq 0$ and with $r = \pm m/n$ in lowest terms, factor m and n into products of primes as $m = \prod_{i=1}^k p_i^{a_i}$ and $n = \prod_{j=1}^l q_j^{b_j}$. Then $|r|_{p_i} = p_i^{-a_i}$ and $|r|_{q_j} = q_j^{b_j}$. Hence

$$\prod_{p \text{ prime}} |r|_p = \left(\prod_{i=1}^k p_i^{-a_i} \right) \left(\prod_{j=1}^l q_j^{b_j} \right) = |r|^{-1} \quad \text{and} \quad \prod_{v \in P} |r|_v = |p|^{-1} |p|_\infty = 1.$$

33. The product of topological groups is a topological group, and thus each $X(S)$ is a topological group. The defining properties of a group depend only on finitely many elements at a time, and these will all be in some $X(S)$. Thus X acquires a group structure. The operations are continuous because again they can be considered in a suitable neighborhood of each point, and these points can be taken to be in some $X(S) \times X(S)$ in the case of multiplication, or in some $X(S)$ in the case of inversion. Thus X is a topological group. The assertions about the situation with topological rings are handled similarly.

35. By continuity of translations, it is enough to find an open neighborhood U of 0 in $\mathbb{A}_\mathbb{Q}$ with $U \cap \mathbb{Q} = \{0\}$. Since each $\mathbb{A}_\mathbb{Q}(S)$ is open in $\mathbb{A}_\mathbb{Q}$, it is enough to find this U in some $\mathbb{A}_\mathbb{Q}(S)$. We do so for $S = \{\infty\}$. Let $U = (-1/2, 1/2) \times \left(\prod_{p \text{ prime}} \mathbb{Z}_p \right)$. If x is in U , then $|x|_p \leq 1$ for all primes p and $|x|_\infty < 1/2$. By Problem 32, x cannot be

in \mathbb{Q} unless $x = 0$. Hence $U \cap \mathbb{Q} = \{0\}$. Proposition 6.3b shows that \mathbb{Q} is therefore discrete.

36. If $x = (x_v)$ is in $\mathbb{A}_{\mathbb{Q}}$, let p_1, \dots, p_n be the primes p where $|x_p|_p > 1$, and let $|x_p|_p = p_j^{a_j}$. If $r = \prod_{j=1}^n p_j^{-a_j}$ and if we regard r as embedded diagonally in $\mathbb{A}_{\mathbb{Q}}$, then $|x_p r^{-1}|_p \leq 1$ for every prime p . Hence xr^{-1} is in $\mathbb{A}_{\mathbb{Q}}(\{\infty\})$. Choose an integer n such that $|x_{\infty} r^{-1} - n|_{\infty} \leq 1$. If we then regard n as embedded diagonally in $\mathbb{A}_{\mathbb{Q}}$, then $|n|_p \leq 1$ for all primes p , and hence n is in $\mathbb{A}_{\mathbb{Q}}(\{\infty\})$. Thus $xr^{-1} - n$ is in the compact subset $K = [-1, 1] \times (\prod_{p \text{ prime}} \mathbb{Z}_p)$ of $\mathbb{A}_{\mathbb{Q}}$. The continuous image of K in $\mathbb{A}_{\mathbb{Q}}/\mathbb{Q}$ is compact, and we have just seen that this image is all of $\mathbb{A}_{\mathbb{Q}}/\mathbb{Q}$. Thus $\mathbb{A}_{\mathbb{Q}}/\mathbb{Q}$ is compact.

37. Fix a finite subset S of P containing $\{\infty\}$. Then the projection of $\prod_{w \in S} \mathbb{Q}_w^{\times}$ to \mathbb{Q}_v^{\times} is continuous for each $v \in S$. Since also the inclusion $\mathbb{Q}_v^{\times} \rightarrow \mathbb{Q}_v$ is continuous, the composition $\prod_{w \in S} \mathbb{Q}_w^{\times} \rightarrow \mathbb{Q}_v$ is continuous. Thus the corresponding mapping $\prod_{w \in S} \mathbb{Q}_w^{\times} \rightarrow \prod_{w \in S} \mathbb{Q}_w$ is continuous. In similar fashion $\prod_{w \notin S} \mathbb{Z}_w^{\times} \rightarrow \mathbb{Z}_v$ is a continuous function as a composition of continuous functions. Thus $\prod_{w \notin S} \mathbb{Z}_w^{\times} \rightarrow \prod_{w \notin S} \mathbb{Z}_w$ is continuous. Putting these two compositions together shows that $\mathbb{A}_{\mathbb{Q}}^{\times}(S) \rightarrow \mathbb{A}_{\mathbb{Q}}(S)$ is continuous, and therefore $\mathbb{A}_{\mathbb{Q}}^{\times}(S) \rightarrow \mathbb{A}_{\mathbb{Q}}$ is continuous. Since this is true for each S , it follows that $\mathbb{A}_{\mathbb{Q}}^{\times} \rightarrow \mathbb{A}_{\mathbb{Q}}$ is continuous.

The topologies on the adèles $\mathbb{A}_{\mathbb{Q}}$ and the ideles $\mathbb{A}_{\mathbb{Q}}^{\times}$ are regular and Hausdorff, and they are both separable. Hence $\mathbb{A}_{\mathbb{Q}}$ and $\mathbb{A}_{\mathbb{Q}}^{\times}$ are metric spaces, and the distinction between the topologies can be detected by sequences. Let p_n be the n^{th} prime, and let $x_n = (x_{n,v})$ be the adele with $x_{n,v} = p_n$ if $v = p_n$ and $x_{n,v} = 1$ if $v \neq p_n$. The result is a sequence $\{x_n\}$ of ideles, and we show that it converges to the idele (1) in the topology of the adèles but does not converge in the topology of ideles. In fact, each x_n lies in $\mathbb{A}_{\mathbb{Q}}(\{\infty\})$, which is an open set in $\mathbb{A}_{\mathbb{Q}}$. For each prime p , $x_{n,p} = 1$ if n is large enough, and also $x_{n,\infty} = 1$ for all n . Since $\mathbb{A}_{\mathbb{Q}}(\{\infty\})$ has the product topology, $\{x_n\}$ converges to (1). On the other hand, if $\{x_n\}$ were to converge to some limit x in $\mathbb{A}_{\mathbb{Q}}^{\times}$, then x would have to lie in some $\mathbb{A}_{\mathbb{Q}}^{\times}(S)$, and the ideles x_n would have to be in $\mathbb{A}_{\mathbb{Q}}^{\times}(S)$ for large n . But $(x_{n,v})$ is not in $\mathbb{A}_{\mathbb{Q}}^{\times}(S)$ as soon as v is outside S .

39. In (a), let f be in $C(K)$. Corollary 6.7 shows that the map $k \mapsto kf$ of K into the left translates of f is continuous into $C(K)$. The continuous image of a compact set is compact, and thus f is left almost periodic. Similarly f is right almost periodic.

In (b), let g be in G . Then $(gf)(x) = f(g^{-1}x) = F(\iota(g^{-1}x)) = F(\iota(g)^{-1}\iota(x)) = ((\iota(g)F)(\iota(x)))$ shows that the set of left translates of f can be regarded as a subset of the set of left translates of F . The latter is compact, and hence the closure of the former is compact.

40. We may view the unitary representation Φ as a continuous homomorphism of G into the compact group $K = U(N)$ for some N . If $f(x) = \Phi(x)_{ij}$, then $f(x) = F(\Phi(x))$, where $F : U(N) \rightarrow \mathbb{C}$ is the $(i, j)^{\text{th}}$ entry function. Thus Problem 39b applies.

41. In (a), assume the contrary. Then for some $\epsilon > 0$ and for every neighborhood N of the identity, there exists g_N in N with $\|g_N f - f\|_{\text{sup}} \geq \epsilon$. Here $\{g_N f\}$ is a net in the compact metric space K_f , and there must be a convergent subnet $\{g_{N_\alpha} f\}$ with limit some function h in K_f . Since $\|g_{N_\alpha} f - h\|_{\text{sup}}$ tends to 0, h is not f . Thus $g_{N_\alpha} f$ converges uniformly to h while, by continuity, tending pointwise to f . Since $h \neq f$, we have arrived at a contradiction.

Part (b) follows from the formula $\|g_0(g_1 f) - g_0(g_2 f)\|_{\text{sup}} = \|g_1 f - g_2 f\|_{\text{sup}}$, and part (c) follows from (b), uniform continuity, and completeness of the compact set K_f .

42. Part (a) follows from a remark with Ascoli's Theorem when stated as Theorem 2.56 of *Basic*: the remark says that if we have an equicontinuous sequence of functions from a compact metric space into a compact metric space, then there is a uniformly convergent subsequence. Here if we have a sequence $\{\varphi_n\}$ of isometries of X onto itself, then the φ_n are equicontinuous with $\delta = \epsilon$. Since the domain X is compact and the image X is compact, the sequence has a uniformly convergent subsequence, and we readily check that the limit is an isometry. Since every sequence in Γ has a convergent subsequence, Γ is compact.

For (b), let members of Γ have $\varphi_n \rightarrow \varphi$ and $\psi_n \rightarrow \psi$. Then

$$\rho(\varphi_n \circ \psi_n, \varphi \circ \psi) \leq \rho(\varphi_n \circ \psi_n, \varphi_n \circ \psi) + \rho(\varphi_n \circ \psi, \varphi \circ \psi).$$

The first term on the right side equals $\rho(\psi_n, \psi)$ because φ_n is an isometry, and the second term equals $\rho(\varphi_n, \varphi)$ because $\psi(x)$ describes all members of X as x varies through X . These two terms tend to 0 by assumption and hence $\varphi_n \circ \psi_n \rightarrow \varphi \circ \psi$. This proves continuity of multiplication. Similarly inversion is continuous.

For (c), let $\gamma_n \rightarrow \gamma$ and $x_n \rightarrow x$. Then

$$d(\gamma_n(x_n), \gamma(x)) \leq d(\gamma_n(x_n), \gamma(x_n)) + d(\gamma(x_n), \gamma(x)) \leq \rho(\gamma_n, \gamma) + d(\gamma(x_n), \gamma(x)),$$

and both terms on the right side tend to 0.

43. In (a), let $\{g_n\}$ be a net convergent to g_0 in G , and form $\{t(g_n)\}$. Then $\rho(t(g_n), t(g_0)) = \sup_{h \in K_f} \|t(g_n)h - t(g_0)h\|_{\text{sup}} = \sup_{h \in K_f, x \in G} |t(g_n)h(x) - t(g_0)h(x)| = \sup_{h \in K_f, x \in G} |h(g_n^{-1}x) - h(g_0^{-1}x)| = \sup_{y \in G, x \in G} |(yf)(g_n^{-1}x) - (yf)(g_0^{-1}x)| = \sup_{y \in G, x \in G} |f(y^{-1}g_n^{-1}x) - f(y^{-1}g_0^{-1}x)|$. If this does not tend to 0 as g_n tends to g_0 , then we can find a subnet of $\{g_n\}$, which we write without any change in notation, and some $\epsilon > 0$ such that this supremum is $\geq \epsilon$ for every n . To each such n , we associate some y_n such that $\sup_{x \in G} |f(y_n^{-1}g_n^{-1}x) - f(y_n^{-1}g_0^{-1}x)| \geq \epsilon/2$. By left almost periodicity we can find a subnet of $\{y_n f\}$ that converges uniformly to some function, say H . This function H has to be left uniformly continuous, and we may suppose that $\|y_n f - H\|_{\text{sup}} \leq \epsilon/8$ for $n \geq N$. Then $n \geq N$ implies

$$\begin{aligned} & |(y_n f)(g_n^{-1}x) - (y_n f)(g_0^{-1}x)| \\ & \leq |(y_n f)(g_n^{-1}x) - H(g_n^{-1}x)| + |H(g_n^{-1}x) - H(g_0^{-1}x)| + |H(g_0^{-1}x) - (y_n f)(g_0^{-1}x)| \\ & \leq \frac{\epsilon}{8} + |H(g_n^{-1}x) - H(g_0^{-1}x)| + \frac{\epsilon}{8}. \end{aligned}$$

The left uniform continuity of H implies that the right side is eventually $\leq \frac{3\epsilon}{8}$. This contradicts the condition $\sup_{x \in G} |f(y_n^{-1}g_n^{-1}x) - f(y_n^{-1}g_0^{-1}x)| \geq \epsilon/2$, and (a) is proved.

In (b), the action $\Gamma_f \times K_f \rightarrow K_f$ is continuous by Problem 42c, and therefore $\gamma \mapsto \gamma^{-1}h$ is continuous. Evaluation of members of K_f at 1 is continuous, and hence $F_f(h)$ is continuous on Γ_f . If $\{g_n\}$ is a net with $g_n f \rightarrow h$, then $F_f(h)(\iota_f(g_0)) = ((\iota_f(g_0))^{-1}h)(1) = \lim_n ((\iota_f(g_0))^{-1}g_n f)(1) = \lim_n (g_n f)(g_0) = h(g_0)$.

For (c), we apply (b) with $h = f$. Then f arises from the compact group Γ_f via the construction in Problem 39b. Therefore f is right almost periodic.

44. If f is a given almost periodic function, the function F to use takes an element $\prod_{f'}(\gamma_{f'})$ to $F_f(\gamma_f)$. Then the equality $F(\iota(x)) = F_f(\iota_f(x)) = f(x)$ shows that f arises from the compact group Γ .

45. Problem 44 produces an isomorphism of the algebra $LAP(G)$ of almost periodic functions on G onto $C(\Gamma)$, and the Stone Representation Theorem (Theorem 4.15) produces an isomorphism of $LAP(G)$ with $C(S_1)$, where S_1 is the Bohr compactification of G . The result then follows after applying Problem 23 in Chapter IV.

46. Finite-dimensional unitary representations of Γ give rise to finite-dimensional unitary representations of G , and thus Corollary 6.33 for Γ gives the desired result.

47. Any continuous multiplicative character of K yields a continuous multiplicative character of G . Conversely any continuous multiplicative character of G is almost periodic by Problem 40 and therefore yields a continuous function on K . The multiplicative property of this continuous function on the dense set $p(G)$, together with continuity of multiplication on K , implies that the function on K is a multiplicative character.

Chapter VII

1. If x_0 is in Ω , let φ be a compactly supported smooth function on Ω equal to $(x - x_0)^\alpha$ in an open neighborhood V of x_0 . Then $0 = (P(x, D)u)(x) = (\alpha!)a_\alpha(x)$ on V , and hence $a_\alpha(x) = 0$ for x in V .

2. Within the Banach space $C(\Omega^{\text{cl}}, \mathbb{R})$, S is the vector subspace of all functions u with $Lu = 0$ on Ω . It contains the constants and hence is not 0. The restriction mapping $R : S \rightarrow C(\partial\Omega, \mathbb{R})$ is one-one by the maximum principle (Theorem 7.12), and it has norm 1. Let V be the image of R , and let $R^{-1} : V \rightarrow S$ be the inverse of $R : S \rightarrow V$. The operator R^{-1} has norm 1 as a consequence of the maximum principle. If e_p denotes evaluation at the point p of Ω , then $e_p \circ R^{-1}$ is a bounded linear functional on V of norm 1. The Hahn–Banach Theorem shows that $e_p \circ R^{-1}$ extends to a linear functional ℓ on $C(\partial\Omega, \mathbb{R})$ of norm 1. We know that $\ell(1) = e_p \circ R^{-1}(1) = e_p(1) = 1$. If $f \geq 0$ is a nonzero element in $C(\partial\Omega, \mathbb{R})$, then $1 - f/\|f\|_{\text{sup}}$ has norm ≤ 1 . Therefore $|\ell(1 - f/\|f\|_{\text{sup}})| \leq 1$ and $0 \leq \ell(f/\|f\|_{\text{sup}}) \leq 2$. Thus the

linear functional ℓ is positive. By the Riesz Representation Theorem, ℓ is given by a measure μ_p . Consequently every u in S has $u(p) = \int_{\partial\Omega} u(x) d\mu_p(x)$. Taking $u = 1$ shows that $\mu_p(\partial\Omega) = 1$ for every p .

3. In (a), the line integral $\oint_{|(x,y)|=\varepsilon} (P dx + Q dy)$ is equal to

$$\int_0^{2\pi} \varphi(\varepsilon \cos \theta, \varepsilon \sin \theta) \varepsilon^{-2} ((\varepsilon \cos \theta)(-\varepsilon \sin \theta) + (\varepsilon \sin \theta)(\varepsilon \cos \theta)) d\theta,$$

and the integrand is identically 0. Part (b) is just a computation of partial derivatives. If (c), we know from Green's Theorem that for any positive numbers $\varepsilon < R$,

$$\left(\oint_{|(x,y)|=R} - \oint_{|(x,y)|=\varepsilon} \right) (P dx + Q dy) = \iint_{\varepsilon \leq |(x,y)| \leq R} \left(\frac{\partial Q}{\partial x} - \frac{\partial P}{\partial y} \right) dx dy.$$

With our P and Q , for sufficiently large R , the line integral $\oint_{|(x,y)|=R}$ is 0 since P and Q have compact support, and (a) says that the limit of the line integral $\oint_{|(x,y)|=\varepsilon}$ is 0 as ε decreases to 0. The function $\frac{\partial Q}{\partial x} - \frac{\partial P}{\partial y} = \frac{y\varphi_x - x\varphi_y}{x^2 + y^2}$ is integrable near $(0, 0)$, and we thus conclude from the complete additivity of the integral that $\iint_{\mathbb{R}^2} \left(\frac{y\varphi_x - x\varphi_y}{x^2 + y^2} \right) dx dy = 0$.

In (d), with a new P and Q , the line integral $\oint_{|(x,y)|=\varepsilon} (P dx + Q dy)$ is equal to

$$\int_0^{2\pi} \varphi(\varepsilon \cos \theta, \varepsilon \sin \theta) \varepsilon^{-2} ((-\varepsilon \sin \theta)(-\varepsilon \sin \theta) + (\varepsilon \cos \theta)(\varepsilon \cos \theta)) d\theta.$$

This simplifies to $\int_0^{2\pi} \varphi(\varepsilon \cos \theta, \varepsilon \sin \theta) d\theta$, which tends to $2\pi\varphi(0, 0)$ by continuity of φ . Part (e) is just a computation of partial derivatives, and part (f) is proved in the same way as part (c).

For (g), we have $z^{-1} \frac{\partial \varphi}{\partial \bar{z}} = z^{-1}(\varphi_x + i\varphi_y) = \frac{x-iy}{x^2+y^2}(\varphi_x + i\varphi_y) = \frac{x\varphi_x + y\varphi_y}{x^2+y^2} + \frac{i(x\varphi_y - y\varphi_x)}{x^2+y^2}$. Combining (c) and (f) gives $\iint_{\mathbb{R}^2} z^{-1} \frac{\partial \varphi}{\partial \bar{z}} dx dy = -2\pi\varphi(0, 0) + i0$, and hence $\frac{1}{2\pi} \iint_{\mathbb{R}^2} z^{-1} \frac{\partial \varphi}{\partial \bar{z}} = -\varphi(0, 0)$.

For (h), we use (g) and obtain $\langle \frac{\partial T}{\partial \bar{z}}, \varphi \rangle = -\langle T, \frac{\partial \varphi}{\partial \bar{z}} \rangle = -\iint_{\mathbb{R}^2} (2\pi z)^{-1} \frac{\partial \varphi}{\partial \bar{z}} dx dy = \varphi(0, 0) = \langle \delta, \varphi \rangle$.

4. In (a), let φ be in $C_{\text{com}}^\infty(\mathbb{R}^1)$. Then $\langle D_x H, \varphi \rangle = -\langle H, \varphi' \rangle = -\int_{-\infty}^{\infty} H(x)\varphi'(x) dx = -\int_0^{\infty} \varphi'(x) dx = -\lim_N [\varphi(x)]_0^N = \varphi(0) = \langle \delta, \varphi \rangle$.

In (b) let φ be in $C_{\text{com}}^\infty((-1, 1))$. We are to verify that $\int_{-1}^1 \max\{x, 0\}\varphi'(x) dx = -\int_{-1}^1 H(x)\varphi(x) dx$, i.e., that $\int_0^1 x\varphi'(x) dx = -\int_0^1 \varphi(x) dx$. This follows from integration by parts because $\int_0^1 x\varphi'(x) dx = [x\varphi(x)]_0^1 - \int_0^1 \varphi(x) dx = -\int_0^1 \varphi(x) dx$.

The answer to (c) is no. If g were a weak derivative, then the left side of the equality $\int_{-1}^1 H(x)\varphi'(x) dx = -\int_{-1}^1 g(x)\varphi(x) dx$ would be 0 whenever $\varphi \in C_{\text{com}}^\infty((-1, 1))$ vanishes in a neighborhood of 0. Then $g(x)$ would have to be 0 almost everywhere for $x \neq 0$, and we would necessarily have $0 = \int_0^1 \varphi'(x) dx = [\varphi(x)]_0^1 = -\varphi(0)$ for all φ in $C_{\text{com}}^\infty((-1, 1))$.

In (d), $\langle D_x(H \times \delta), \varphi \rangle = -\langle H \times \delta, D_x \varphi \rangle = -\int_0^\infty (D_x \varphi)(x, 0) dx$, and this $= -\lim_N [\varphi(x, 0)]_{x=0}^{x=N} = \varphi(0, 0) = \langle \delta, \varphi \rangle$.

In (e), the support of H is $[0, \infty)$ and the singular support is $\{0\}$, while for $H \times \delta$ the support and the singular support are both $\mathbb{R} \times \{0\}$.

5. We apply Lemma 7.8 to $R(x) = P(ix)$. The preliminary step in the proof multiplies the given distribution f by something so that f has support near 0. We form $e^{-i\alpha \cdot x} f$ as a member of $\mathcal{E}'((-\infty, 2\pi)^N)$ and restrict it to a member of $\mathcal{P}'(T^N)$. Then it has a Fourier series $e^{-i\alpha \cdot x} f \sim \sum_k d_k e^{ik \cdot x}$. Put $c_k = \frac{d_k}{R(k+\alpha)}$, α being the member of \mathbb{R}^N produced by the lemma. Then $|c_k| \leq C(1+|k|^2)^p$ for some p , and (b) produces a distribution S in $\mathcal{E}'((-\infty, 2\pi)^N)$ with $\langle S, e^{-ik \cdot x} \rangle = c_k$ for all k . Define $u = e^{i\alpha \cdot x} S$ as a member of $\mathcal{E}'((-\infty, 2\pi)^N)$. Let $\psi(x)$ be a smooth function with compact support near 0, and extend ψ to be periodic, i.e., to be in $C^\infty(T^N)$. The multiple Fourier series of ψ is then of the form $\psi(x) = \sum_k \gamma_k e^{ik \cdot x}$ with γ_k decreasing faster than any power of $|k|$. The function $\varphi(x) = \psi(x)e^{-i\alpha \cdot x}$ is in $C^\infty((-\infty, 2\pi)^N)$ but is not necessarily periodic. Applying $P(D)$ to u and having the result act on φ , we write

$$\langle P(D)u, \varphi \rangle = \langle P(D)u, \sum_k \gamma_k e^{i(k-\alpha) \cdot x} \rangle = \langle P(D)u, \sum_k \gamma_{-k} e^{-i(k+\alpha) \cdot x} \rangle.$$

Since the γ_k are rapidly decreasing and $P(D)u$ is continuous on $C^\infty((-\infty, 2\pi)^N)$, we can interchange the summation and the operation of $P(D)u$. Thus the right side of the display is

$$\begin{aligned} \sum_k \gamma_{-k} \langle P(D)u, e^{-i(k+\alpha) \cdot x} \rangle &= \sum_k \gamma_{-k} \langle u, P(-D)(e^{-i(k+\alpha) \cdot x}) \rangle \\ &= \sum_k \gamma_{-k} \langle e^{i\alpha \cdot x} S, P(i(k+\alpha))e^{-i(k+\alpha) \cdot x} \rangle = \sum_k \gamma_{-k} \langle S, P(i(k+\alpha))e^{-ik \cdot x} \rangle \\ &= \sum_k \gamma_{-k} c_k P(i(k+\alpha)) = \sum_k \gamma_{-k} \frac{d_k}{R(k+\alpha)} P(i(k+\alpha)) = \sum_k \gamma_{-k} d_k. \end{aligned}$$

Now $d_k = \langle e^{-i\alpha \cdot x} f, e^{-ik \cdot x} \rangle$. The rapid convergence of the series $\sum_k \gamma_{-k} e^{-ik \cdot x}$ means that $\langle e^{-i\alpha \cdot x} f, \psi \rangle = \sum_k \gamma_{-k} \langle e^{-i\alpha \cdot x} f, e^{-ik \cdot x} \rangle = \sum_k \gamma_{-k} d_k$. Therefore $\langle P(D)u, \varphi \rangle = \sum_k \gamma_{-k} d_k = \langle e^{-i\alpha \cdot x} f, \psi \rangle = \langle e^{-i\alpha \cdot x} f, e^{i\alpha \cdot x} \varphi \rangle = \langle f, \varphi \rangle$. Near 0, the function φ is an arbitrary smooth function, and thus $P(D)u = f$ near 0.

6. The coefficient of x^α in $(x_1 + \cdots + x_N)^{|\alpha|}$ is the multinomial coefficient $\binom{|\alpha|}{\alpha_1, \dots, \alpha_N} = \frac{|\alpha|!}{\alpha!}$. This is a positive integer, and hence $\alpha! \leq |\alpha|!$. Fixing $|\alpha| = l$ and putting $x_1 = \cdots = x_N = 1$, we obtain the formula $N^l = \sum_{|\alpha|=l} \frac{l!}{\alpha!}$, and therefore $\sum_{|\alpha|=l} (1/\alpha!) = N^l/l!$. The identity with z can be proved by induction on q , the base case being $q = 0$, where the expansion is a geometric series. If the case q is known, we differentiate both sides and divide by $q+1$ to obtain the case $q+1$. Alternatively, one can derive the identity from the binomial series expansion in Section I.7 of *Basic*.

7. Here is the solution apart from some details. The argument uses induction, the base case being $m = 1$, where the result describes the given system of differential equations. Assuming that D_i^{m-1} is of the asserted form, we differentiate the expression

with respect to t . In the 2^{m-1} terms of the first kind, the derivative acts on some expression $D_x^\alpha u$, giving $D_x^\alpha D_t u$. We substitute for $D_t u$ from the given system and sort out what happens; we get 2^m terms involving an x derivative of u and 2^{m-1} terms involving a derivative of F . In the $2^{m-1} - 1$ terms of the second kind, the derivative acts on some iterated partial derivative of F and just raises the order of differentiation. The total number of terms involving F is then $2^{m-1} + 2^{m-1} - 1 = 2^m - 1$.

8. In (a), just apply D_x^β to the formula for $D_t^m u$ in the previous problem. The operator gets applied to each u or F that appears in the formula, and there is no simplification. Then one evaluates at $(0, 0)$. In (b), the asserted finiteness implies that the multiple power series

$$U(x, t) = \sum_{\beta} \sum_{m \geq 0} \frac{D_x^\beta D_t^m u(0, 0)}{\beta! m!} x^\beta t^m$$

converges when $|t| < r$ and $|x_j| < r$ for all j and that $D_x^\beta D_t^m U(0, 0) = D_x^\beta D_t^m u(0, 0)$ for all β and m . Then it follows that the sum $U(x, t)$ solves the given Cauchy problem for these values of (x, t) . Since r is arbitrary, the series converges for all $(x, t) \in \mathbb{C}^{N+1}$ and the sum $U(x, t)$ solves the Cauchy problem globally.

9. In (a), we consider a single term of the expansion of $D_t^m u(0, 0)$, namely $T_1 \cdots T_m D_x^\alpha u(0, 0) = T_1 \cdots T_m D_x^\alpha g(0)$. Here each of T_1, \dots, T_m is equal to some A_{j_i} or to B , and D_x^α is the product over i of the D_{j_i} for those T_i with $T_i = A_{j_i}$. The term has $\|T_1 \cdots T_m D_x^\alpha g(0)\|_\infty \leq M^m \|D_x^\alpha g(0)\|_\infty$, and the boundedness of the series involving $g(0)$ implies that $(\alpha!)^{-1} \|D_x^\alpha g(0)\|_\infty R^{|\alpha|} \leq C$. Let k be the number of factors of $T_1 \cdots T_m$ equal to B . Then $|\alpha| = m - k$, and hence $M^m \|D_x^\alpha g(0)\|_\infty \leq C M^m \alpha! R^{-(m-k)}$. Each T_i equal to A_{j_i} has to be summed over the N values of j_i , and we get a contribution of N^{m-k} from all these sums. Finally the number of such terms involving k factors B is the number of subsets of k elements in a set of m elements and is $\binom{m}{k}$, and $\alpha! \leq (m-k)!$ by Problem 6. The desired estimate results.

In (b), we adjust the above estimate by replacing $\|D_x^\alpha g(0)\|_\infty$ by $\|D_x^{\alpha+\beta} g(0)\|_\infty$. Then $C \alpha! R^{-(m-k)}$ gets replaced by $C(\alpha + \beta)! R^{-(m-k+l)}$, where $l = |\beta|$. Since $(\alpha + \beta)! \leq (m-k+l)!$, the term is $\leq \sum_{k=0}^m C M^m N^{m-k} (m-k+l)! \binom{m}{k} R^{-(m-k+l)}$.

In (c), we are to sum the product of the estimate in (b) by $\frac{r^{l+m}}{\beta! m!}$, the sum extending over all $m \geq 0$, all $l \geq 0$, and all β with $|\beta| = l$. Thus we are to bound

$$\begin{aligned} & \sum_{m=0}^{\infty} \sum_{l=0}^{\infty} \sum_{|\beta|=l} \sum_{k=0}^m \frac{C M^m N^{k-m} (m-k+l)! \binom{m}{k} R^{-(m-k+l)} r^{l+m}}{\beta! m!} \\ &= \sum_{m=0}^{\infty} \sum_{l=0}^{\infty} \sum_{k=0}^m \frac{C M^m N^{m-k+l} (m-k+l)! \binom{m}{k} R^{-(m-k+l)} r^{l+m}}{l! m!} \end{aligned}$$

$$\begin{aligned}
&= C \sum_{m=0}^{\infty} \sum_{k=0}^{\infty} \left[\sum_{l=0}^{\infty} \binom{m-k+l}{l} \left(\frac{Nr}{R}\right)^l \right] \frac{M^m N^{m-k} R^{-(m-k)} r^m}{k!} \\
&= C \sum_{m=0}^{\infty} \sum_{k=0}^{\infty} \left(1 - \frac{Nr}{R}\right)^{-(m-k)-1} \frac{M^m N^{m-k} R^{-(m-k)} r^m}{k!},
\end{aligned}$$

the first and third steps using Problem 6 and the third step requiring the assumption on R that $Nr/R < 1$. If we assume in fact that $Nr/R \leq 1/2$, then $(1 - \frac{Nr}{R})^{-1} \leq 2$, and the above expression is

$$\leq C \sum_{m=0}^{\infty} \sum_{k=0}^{\infty} \frac{2^{m-k+1} M^m N^{m-k} R^{-(m-k)} r^m}{k!} \leq 2C \sum_{m=0}^{\infty} e^{R/(2N)} \left(\frac{2MrN}{R}\right)^m,$$

the second inequality following from the series expansion of the exponential function. The series on the right is convergent if $2MrN/R < 1$. This proves (c).

In (d), the analog of (a) is to consider a term $T_1 \cdots T_s D_x^\alpha D_t^{m-1-s} F$, where each T_i is some A_{j_i} or B . Let k be the number of factors B , so that $s - k$ factors are some A_j and $|\alpha| = s - k$. The contributions to D_x^α come from the factors A_j ; regard the $m - 1 - s$ contributions to D_t^{m-1-s} as coming from factors of the identity I . In this way the two phenomena can be handled at the same time. Ignore the fact that I commutes with the other matrices; it is easier to treat it as if its occurrences in different positions were different. The effect is the same as expanding the set of n matrices A_j to include I , yielding a set of $N + 1$ matrices. The requirement $M \geq 1$ makes it so that the estimate $\|Iv\|_\infty \leq M\|v\|_\infty$ is valid for the new member of the set, as well as the old members. The steps for imitating (b) and (c) are then essentially the same as before except that m is replaced by $m - 1$ and N is sometimes replaced by $N + 1$.

10. The crux of the matter is to show that if $\{u^{i,j}(x, y)\}$ solves the Cauchy problem for the first-order system, then $u^{i,j}(x, y) = D_x^i D_y^j u^{0,0}(x, y)$ for $i + j \leq m$ and hence $u^{0,0}(x, y)$ solves the m^{th} -order equation. The proof proceeds by induction on j . The case $j = 0$ is okay because the first-order system has $D_x u^{i,0} = u^{i+1,0}$ for $i < m$. Suppose the identity holds for some j . Then $D_x u^{i,j+1} = D_y u^{i+1,j}$ from the system, and this is $D_y D_x u^{i,j}$ by induction. Hence $D_x(u^{i,j+1} - D_y u^{i,j}) = 0$, and we obtain $u^{i,j+1} - D_y u^{i,j} = c(y)$. Put $x = 0$ and get $u^{i,j+1}(0, y) = D_y^{j+1} f^{(i)}(y) = D_y D_y^j f^{(i)}(y) = D_y u^{i,j}(0, y)$. Therefore $c(y) = 0$, and $u^{i,j+1} = D_y u^{i,j} = D_x^i D_y^{j+1} u^{0,0}$. This completes the induction.

11. The second index (j in Problem 10) is replaced by an $(N - 1)$ -tuple $\alpha = (\alpha_1, \dots, \alpha_{N-1})$. If $\beta \neq 0$, the equation for $D_x u^{i,\beta}$ is $D_x u^{i,\beta} = D_{y_j} u^{i,\alpha}$, where j is the first index for which $\alpha_j \neq 0$ and where α is obtained from β by reducing the j^{th} index by 1. If $\beta = 0$, the equations are as in Problem 10. The Cauchy data are $u^{i,\beta}(0, y) = D_y f^{(i)}(y)$ except when $(i, \beta) = (m, 0)$, and they are the data of Problem 10 when $(i, \beta) = (m, 0)$. The argument now inducts on $\beta_1, \dots, \beta_{N-1}$, and

the functions $c(y)$ that appear are of the form $c(y_1, \dots, y_{N-1})$. The Cauchy data are for $x = 0$, and we get an equation $c(y_1, \dots, y_{N-1}) = 0$ in one step in each case.

12. The equations $D_x u^{i,j+1} = D_y u^{i+1,j}$ involve first partial derivatives in the y direction with coefficient 1, and $D_x u^{i,0} = u^{i+1,0}$ involves an undifferentiated variable with coefficient 1. The equation for $D_x u^{m,0}$ involves a linear combination of variables and first partial derivatives in the y direction of variables, plus the term F_x , which is an entire holomorphic function of (x, y) . So the equations of the first-order system are as in Problems 6–9.

Chapter VIII

1. What needs checking is that the two charts are smoothly compatible. The set $M_{\kappa_1} \cap M_{\kappa_2}$ is $S^n - \{(0, \dots, 0, \pm 1)\}$, and the image of this under κ_1 and κ_2 is $\mathbb{R}^n - \{(0, \dots, 0)\}$. Put $y_j = x_j/(1-x_{n+1})$, so that $\kappa_1^{-1}(y_1, \dots, y_n) = (x_1, \dots, x_{n+1})$. Then

$$\begin{aligned} \kappa_2 \circ \kappa_1^{-1}(y_1, \dots, y_n) &= (x_1/(1+x_{n+1}), \dots, x_n/(1+x_{n+1})) \\ &= (y_1(1-x_{n+1})/(1+x_{n+1}), \dots, y_n(1-x_{n+1})/(1+x_{n+1})). \end{aligned}$$

To compute $(1-x_{n+1})/(1+x_{n+1})$, we take $|x| = 1$ into account and write $1 = \sum_{j=1}^{n+1} x_j^2 = x_{n+1}^2 + \sum_{j=1}^n y_j^2(1-x_{n+1})^2$. Then $\sum_{j=1}^n y_j^2 = (1-x_{n+1}^2)/(1-x_{n+1})^2 = (1+x_{n+1})/(1-x_{n+1})$, and

$$\kappa_2 \circ \kappa_1^{-1}(y_1, \dots, y_n) = (y_1 / \sum_{j=1}^n y_j^2, \dots, y_n / \sum_{j=1}^n y_j^2).$$

The entries on the right are smooth functions of y since $y \neq 0$, and the two charts are therefore smoothly compatible.

3. If it is σ -compact, it is Lindelöf. If it is Lindelöf, countably many charts suffice to cover X . If there is a countable dense set, then we can choose one chart for each member of the dense set, and these will have to cover X . This proves (a). For (b), each chart has a countable base, and the union of these countable bases, as the chart varies, is a countable base for X .

4. For (a), multiplication is given by polynomial functions, which are smooth. Inversion, according to Cramer's rule, is given by polynomial functions and division by the determinant, and inversion is therefore smooth.

For (b), we have

$$\begin{aligned} \tilde{A}_g f &= (dl_g)_1(A)(f) = A(f \circ l_g) = A(f(g \cdot)) = \sum_{i,j} A_{ij} \frac{\partial(f(g \cdot))}{\partial x_{ij}}(1) \\ &= \sum_{i,j} A_{ij} \sum_{r,s} \frac{\partial f}{\partial x_{rs}}(g) \frac{\partial((g \cdot)_{rs})}{\partial x_{ij}}(1) = \sum_{i,j,r,s} A_{ij} \frac{\partial f}{\partial x_{rs}}(g) g_{ri} \delta_{sj} \\ &= \sum_{j,r,s} (gA)_{rj} \delta_{sj} \frac{\partial f}{\partial x_{rs}}(g) = \sum_{r,s} (gA)_{rs} \frac{\partial f}{\partial x_{rs}}(g). \end{aligned}$$

For (c), the condition for smoothness, by Proposition 8.8, is that all $\tilde{A}x_{ij}$ be smooth functions. Part (b) gives $\tilde{A}x_{ij}(g) = \tilde{A}_g(x_{ij}) = \sum_{r,s} (gA)_{rs} \delta_{ir} \delta_{js} = (gA)_{ij} = \sum_k g_{ik} A_{kj}$, and the right side is a smooth function of the entries of g . For the left invariance, let $F = l_h$, and put $g' = F^{-1}(g) = h^{-1}g$. We are to check that $(dF)_{g'}(\tilde{A}_{g'})(f) = \tilde{A}_g(f)$ if f is defined near g . The left side is equal to $\tilde{A}_{g'}(f \circ l_h) = ((dl_{g'})_1(A))(f \circ l_h) = (dl_h)_{g'}(dl_{g'}^{-1}_1(A))(f)$, and the right side is $\tilde{A}_g(f) = (dl_g)_1(A)(f)$. These two expressions are equal by Proposition 8.7.

Parts (d) and (e) amount to the same thing. For (d), the question is whether $\tilde{A}_{g_0 \exp t A} f = (dc)_t(\frac{d}{dt})(f)$. The right side is $\frac{d}{dt} f(g_0 \exp t A)$, and that is why (d) and (e) amount to the same thing. The left side is $\sum_{r,s} (g_0(\exp t A)A)_{rs} \frac{\partial f}{\partial x_{rs}}(g_0 \exp t A)$ by (b), and this expression equals $\frac{d}{dt} f(g_0 \exp t A)$ by the chain rule and the formula $\frac{d}{dt} \exp t A = (\exp t A)A$ known from *Basic*.

5. For (a), fix l . Choose, for each p in L_l , a compatible chart about p such that the closure of the domain of the chart is a compact subset of U_l . The domains of these charts form an open cover of L_l , and we extract a finite subcover. Taking the union of such subcovers on l , we obtain the atlas $\{\kappa_\alpha\}$.

For (b) and (d), the solution will be a translation into the language of smooth manifolds of a proof given in introducing Corollary 3.19: In (b), let the domains of the charts constructed at stage l be $M_{\kappa_1}, \dots, M_{\kappa_r}$. Lemma 3.15b of *Basic* constructs an open cover $\{W_1, \dots, W_r\}$ of L_l such that W_j^{cl} is a compact subset of M_{κ_j} for each j . A second application of Lemma 3.15b of *Basic* produces an open cover $\{V_1, \dots, V_r\}$ of L_l such that V_j^{cl} is compact and $V_j^{\text{cl}} \subseteq W_j$ for each j . Proposition 8.2 constructs a smooth function $g_j \geq 0$ that is 1 on V_j^{cl} and is 0 off W_j . Then $\sum_{j=1}^r g_j$ is > 0 on L_l and has compact support in $\bigcup_{j=1}^r M_{\kappa_j}$. If we write $\{\eta_\alpha\}$ for the union of the sets $\{g_1, \dots, g_r\}$ as l varies, then the functions $\varphi_\alpha = \eta_\alpha / \sum_\beta \eta_\beta$ have the required properties.

For (c), we apply (b) to the smooth manifold U . The construction in (b) is arranged so that about each point is an open neighborhood on which only finitely many φ_α 's can be nonzero. As this point varies through K , the open neighborhoods cover K , and there is a finite subcover. Therefore only finitely many φ_α 's have the property that they are somewhere nonzero on K . The sum of this finite subcollection of all φ_α 's is then a smooth function with values in $[0, 1]$ that is 1 everywhere on K and has compact support in U .

For (d), we argue as in (b) with two applications of Lemma 3.15b of *Basic* to produce an open cover $\{V_1, \dots, V_r\}$ of K such that for each j , V_j^{cl} is a compact subset of W_j , whose closure is a compact subset of U_j . Part (c) constructs a smooth function $g_j \geq 0$ that is 1 on V_j^{cl} and is 0 off W_j . Then $g = \sum_{j=1}^r g_j$ is > 0 everywhere on K and has compact support in $\bigcup_{j=1}^r U_j$. A second application of (c) produces a smooth function $h \geq 0$ on M with values in $[0, 1]$ that is 1 on K and is compactly supported within the set where $g > 0$. Then $g + (1 - h)$ is smooth and everywhere positive on M , and the functions $\varphi_j = g_j / (g + (1 - h))$ have the required properties.

6. In the notation of Proposition 8.6, the matrix $\left[\frac{\partial F_i}{\partial u_j} \Big|_{(u_1, \dots, u_n) = (x_1(p), \dots, x_n(p))} \right]$, which is of size k -by- n , has rank k . Choose k linearly independent columns. Possibly after a change of notation that will not affect the conclusion, we may assume that they are the first k columns. Call the n functions $y_1 \circ F, \dots, y_k \circ F, x_{k+1}, \dots, x_n$ by the names f_1, \dots, f_n . These are in $C^\infty(M_k)$ and have matrix $\left[\frac{\partial(f_i \circ \kappa^{-1})}{\partial u_j} \right]$ of the block form

$$\begin{pmatrix} \left[\frac{\partial F_i}{\partial u_j} \right] & \left[\frac{\partial F_i}{\partial u_j} \right] \\ 0 & 1 \end{pmatrix}$$

at the point where $(u_1, \dots, u_n) = (x_1(p), \dots, x_n(p))$. The upper left corner is invertible by the condition of rank k , and hence the whole matrix is invertible. Then the result follows from Proposition 8.4.

7. In the notation of Proposition 8.6, the matrix $\left[\frac{\partial F_i}{\partial u_j} \Big|_{(u_1, \dots, u_n) = (x_1(p), \dots, x_n(p))} \right]$, which is of size k -by- n , has rank n . Choose n linearly independent rows. Since $F_i = (y_i \circ F) \circ \kappa^{-1}$, Proposition 8.4 shows that the corresponding functions $y_i \circ F$ generate a system of local coordinates near p . This proves (a).

8. A little care is needed with the definition of measure 0 for a manifold because the sets of measure 0 that arise are not shown to be Borel sets. However, for points in the intersection of the domains of two charts κ_1 and κ_2 , the change-of-variables theorem shows that the two versions of Lebesgue measure near the two images in Euclidean space of a point are of the form dx and $(\kappa_1 \circ \kappa_2^{-1})'(x) dx$, and the sets of measure 0 are the same for these.

The solution of the problem as written is a question of localizing matters so that the Euclidean version of Sard's Theorem (Theorem 6.35 of *Basic*) applies. For each point p in M , one can find a chart κ_p with $p \in M_{\kappa_p}$ and a chart λ_p with $F(p) \in N_{\lambda_p}$ such that $F(M_{\kappa_p}) \subseteq N_{\lambda_p}$. The Euclidean theorem applies to $\lambda_p \circ F \circ \kappa_p^{-1}$. The separability implies that countably many of these M_{κ_p} 's cover M . We get measure 0 for the critical values within each $F(M_{\kappa_p})$, and the countable union of sets of measure 0 has measure 0.

9. Here we localize and apply Corollary 6.36 of *Basic*.

10. The reflexive condition follows with $h = 1$, and the transitive condition follows by using the composition of two h 's. Strictly equivalent is the condition "equivalent" with $h = 1$.

11. Substitution of the definitions gives

$$\bar{g}_{kj}(x)g_{ji}(x) = \phi'_{k,x}{}^{-1} \circ h_x \circ \phi_{j,x} \circ \phi_{j,x}^{-1} \circ \phi_{i,x} = \phi'_{k,x}{}^{-1} \circ h_x \circ \phi_{i,x} = \bar{g}_{ki}(x).$$

This proves the first identity, and the second identity is similar.

12. For (a), if x lies in $M_{\kappa_j} \cap M_{\kappa'_k}$ and y lies in \mathbb{F}^n , then the only way that h can have the correct mapping function $x \mapsto \bar{g}_{kj}(x)$ is to have $\bar{g}_{kj}(x)(y) = \phi'_{k,x}{}^{-1}h\phi_{j,x}(y)$. Therefore we must have $h(\phi_{j,x}(y)) = \phi'_{k,x}\bar{g}_{kj}(x)(y)$, and h is unique.

In (b), if h exists, then it is apparent from the formula for it that it is a diffeomorphism. In this case the function h^{-1} exhibits the relation “equivalent” as symmetric.

13. For (a), if x lies also in $M_{\kappa_i} \cap M_{\kappa'_l}$, then we have

$$p_j(b) = \phi_{j,x}^{-1}(b) = \phi_{j,x}^{-1}\phi_{i,x}\phi_{i,x}^{-1}(b) = g_{ji}(x)(p_i(b))$$

and hence

$$\begin{aligned} h_{kj}(b) &= \phi'_{k,x}\bar{g}_{kj}(x)(p_j(b)) = \phi'_{k,x}\bar{g}_{kj}(x)g_{ji}(x)(p_i(b)) = \phi'_{k,x}\bar{g}_{ki}(x)(p_i(b)) \\ &= \phi'_{l,x}g'_{lk}(x)\bar{g}_{ki}(x)(p_i(b)) = \phi'_{l,x}\bar{g}_{li}(x)(p_i(b)) = h_{li}(b). \end{aligned} \quad (*)$$

The sets $p^{-1}(M_{\kappa_j} \cap M_{\kappa'_k})$ are open and cover B as j and k vary, and the consistency condition (*) therefore shows that the functions h_{kj} piece together as a single smooth function $h : B \rightarrow B'$.

For (b), let y be in \mathbb{F}^n . Put $b = \phi_{j,x}(y)$ in the definition of $h_{kj}(b)$, so that $y = \phi_{j,x}^{-1}(b) = p_j(b)$, and then we have

$$\phi'_{k,x}{}^{-1}h\phi_{j,x}(y) = \phi'_{k,x}{}^{-1}h(b) = \phi'_{k,x}{}^{-1}\phi'_{k,x}\bar{g}_{kj}(x)(p_j(b)) = \bar{g}_{kj}(x)(y).$$

This shows that the functions $x \mapsto \bar{g}_{kj}(x)$ coincide with the mapping functions of h .

Chapter IX

1. The formula is $\mu_{|x|} = \mu_x + \mu_x^\vee - \frac{1}{2}\mu(\{0\})$, where μ_x^\vee is the measure on \mathbb{R} defined by $\mu_x^\vee(A) = \mu_x(-A)$.

2. Both sides equal $\int_{\Omega} \Phi(x_1, \dots, x_n) dP$.

3. For (a), we have $\sigma_n^2 = \int_{\mathbb{R}} (t - E)^2 d\mu_n(t) \geq \int_{|t-E| \geq \delta} (t - E)^2 d\mu_n(t) \geq \delta^2 P(\{|y_n - E| \geq \delta\})$.

For (b), we calculate

$$\begin{aligned} |E(\Phi(y_n)) - \Phi(E)| &= \left| \int_{\mathbb{R}} [\Phi(t) - \Phi(E)] d\mu_n(t) \right| \leq \int_{\mathbb{R}} |\Phi(t) - \Phi(E)| d\mu_n(t) \\ &= \int_{|t-E| < \delta} + \int_{|t-E| \geq \delta} \leq \int_{|t-E| < \delta} \epsilon d\mu_n(t) + 2MP(\{|y_n - E| \geq \delta\}) \\ &\leq \epsilon + 2M\sigma_n^2\delta^{-2}. \end{aligned}$$

In (c), let $\epsilon > 0$ be given, and choose the δ of continuity for Φ and ϵ . Then the calculation in (b) applies. Since $\lim \sigma_n^2 = 0$, the right side is $\leq 2\epsilon$ for n large enough. For such n , we have $|E(\Phi(y_n)) - \Phi(E)| \leq 2\epsilon$.

In (d), the argument of (c) depends only on the continuity of Φ at E and the global boundedness of Φ . In the situation of Theorem 9.7 with independent identically distributed random variables x_n , we put $s_n = x_1 + \cdots + x_n$ and take $y_n = \frac{1}{n} s_n$. We saw that if $E(x_k) = E$ and $\text{Var}(x_k) = \sigma^2$, then $E(y_n) = E$ and $\text{Var}(y_n) = \frac{1}{n} \sigma^2$. Thus (c) applies.

4. Part (a) is a direct application of the Kolmogorov Extension Theorem. One starts with the measure on \mathbb{R}^1 that assigns mass p to $\{1\}$ and mass $1 - p$ to $\{0\}$, forms the n -fold product to model n independent tosses, and obtains the space for a sequence of tosses from the Kolmogorov Theorem.

In (b), the mean is $p \cdot 1 + (1 - p) \cdot 0 = p$. The computation for the variance is $p \cdot 1^2 + (1 - p) \cdot 0^2 - p^2 = p - p^2 = p(1 - p)$.

For (c), the answer is the number of ways of obtaining k heads and $n - k$ tails in n tosses, namely $\binom{n}{k}$, times the probability of getting a specific sequence of k heads and $n - k$ tails, which is $p^k (1 - p)^{n-k}$.

In (d), we put $y_n = \frac{1}{n} s_n$. In view of (c), $E(y_n)$ is $\sum_{k=0}^n \Phi\left(\frac{k}{n}\right) \binom{n}{k} p^k (1 - p)^{n-k}$, and (a) shows that $\Phi(E)$ is $\Phi(p)$. The variance of y_n is $\frac{p(1-p)}{n}$, in view of (b); since this tends to 0, Problem 3c is applicable and establishes the limit formula.

For (e), we go over the solution of Problem 3. The relevant facts for making an estimate that is uniform in p are that Φ is uniformly continuous and that the convergence of the variance to 0 is uniform in p .

6. For the regularity any set in \mathcal{F} is in some \mathcal{F}_n . The sets in \mathcal{F}_n are of the form $\tilde{E} = E \times \left(\prod_{k=n+1}^{\infty} X_k\right)$ with $E \subseteq \Omega^{(n)}$ and $v(\tilde{E}) = v_n(E)$. Given $\epsilon > 0$, choose K compact and U open in $\Omega^{(n)}$ with $K \subseteq E \subseteq U$ and $v_n(U - K) < \epsilon$. In Ω , \tilde{K} is compact, \tilde{U} is open, $\tilde{K} \subseteq \tilde{E} \subseteq \tilde{U}$, and $v(\tilde{U} - \tilde{K}) < \epsilon$.

7. Let $E = \bigcup_{n=1}^{\infty} E_n$ disjointly in \mathcal{F} . Since v is nonnegative additive, we have $\sum_{n=1}^{\infty} v(E_n) \leq v(E)$. For the reverse inequality let $\epsilon > 0$ be given. Choose K compact and U_n open with $K \subseteq E$, $E_n \subseteq U_n$, $v(U_n - E_n) < \epsilon/2^n$, and $v(E - K) < \epsilon$. Then $K \subseteq \bigcup_{n=1}^{\infty} U_n$, and the compactness of K forces $K \subseteq \bigcup_{n=1}^N U_n$ for some N . Then $v(E) \leq v(K) + \epsilon \leq v\left(\bigcup_{n=1}^N U_n\right) + \epsilon \leq \sum_{n=1}^N v(U_n) + \epsilon \leq \sum_{n=1}^N v(E_n) + 2\epsilon \leq \sum_{n=1}^{\infty} v(E_n) + 2\epsilon$. Since ϵ is arbitrary, $v(E) \leq \sum_{n=1}^{\infty} v(E_n)$.

8. The key is that Ω is a separable metric space. Every open set is therefore the countable union of basic open sets, which are in the various \mathcal{F}_n 's.

10. The collection of subsets of Ω that are of type J for some countable J is a σ -algebra containing \mathcal{A}' , and thus it contains \mathcal{A} .

11. Continuity cannot be ensured by conditions at only countably many points, as we see by altering the value of the function at a point not in a prospective such countable set of points.

12. A nonempty set of \mathcal{A} that is contained in C must be defined in terms of what happens at countably many points, and no such conditions are possible, just as in the

previous problem. So the set must be empty. Since $\rho_*(C)$ is the supremum of ρ of all such sets, we obtain $\rho_*(C) = 0$.

13. If ω is in C_j but not E , then the uniform continuity of ω means that $\omega|_J$ extends to a member of C . In other words, there is a member ω' of Ω that is 0 on J such that $\omega + \omega'$ is in C . Since $C \subseteq E$, $\omega + \omega'$ is in E . The set E is by assumption of type J , and therefore the sum of any member of E with a member of Ω that vanishes on J is again in E . Hence $\omega = (\omega + \omega') - \omega'$ is in E , contradiction.

14. Problem 13 shows that the infimum of $\rho(E)$ for all E in \mathcal{A} containing C equals the infimum over all countable J of $\rho(C_J)$. Under the assumption this infimum is 1. Thus $\rho^*(C) = 1$.

15. Proceeding inductively and using the convergence in probability, we can construct a subsequence $\{x_{n_k}\}$ of $\{x_n\}$ with $P(|x_{n_k} - x| \leq 2^{-k}) \leq 2^{-k}$ for $k \geq 1$. The series $\sum_{k=1}^{\infty} P(|x_{n_k} - x| \leq 2^{-k})$ converges, and the Borel–Cantelli Lemma (Lemma 9.9) shows that except for ω in a set Z of measure 0, $|x_{n_k}(\omega) - x(\omega)| > 2^{-k}$ only finitely often. Thus except when ω is in Z , $\sum_k |x_{n_k}(\omega) - x(\omega)|$ converges. Since

$$|x_{n_{k+1}}(\omega) - x_{n_k}(\omega)| \leq |x_{n_{k+1}}(\omega) - x(\omega)| + |x_{n_k}(\omega) - x(\omega)|$$

for all k , $\sum_k |x_{n_{k+1}}(\omega) - x_{n_k}(\omega)|$ converges. Therefore $\sum_k (x_{n_{k+1}}(\omega) - x_{n_k}(\omega))$ converges. The partial sum of this series through the ℓ^{th} term is $x_{n_{\ell+1}}(\omega) - x_{n_1}(\omega)$, and therefore the series $\sum_k x_{n_k}(\omega)$ converges for all ω not in Z . Since $\{x_{n_k}\}$ converges to some random variable almost surely, Proposition 9.12 shows that the convergence is to x almost surely.

16. Chebyshev's inequality (Section VI.10 of *Basic*) shows that $\int_X |f|^2 d\mu \geq \xi^2 \mu(\{x \mid |f(x)| \geq \xi\})$ for all $\xi > 0$ on any measure space. We apply this with $\mu = P$ and with $f = x_n - c$ to obtain $\xi^2 P(|x_n - c| \geq \xi) \leq E((x_n - c)^2) = \text{Var}(x_n)$. The right side tends to 0 as n tends to infinity, and thus $P(|x_n - c| \geq \xi)$ tends to 0. In other words, $\{x_n\}$ tends to c in probability.

17. Take μ_n to be a unit mass at $\{n\}$, and let $\mu = 0$.

18. According to Problem 4, the mean is $E = p$, and the variance is $\sigma = p(1-p)$. Thus the result follows directly by substituting into Theorem 9.19.

19. In (a), the Binomial Theorem gives $\sum_{k=0}^n \binom{n}{k} \left(\frac{\lambda}{n}\right)^k \left(1 - \frac{\lambda}{n}\right)^{n-k} = \left(\frac{\lambda}{n} + \left(1 - \frac{\lambda}{n}\right)\right)^n$, and the right side is just 1. Also $\sum_{k=0}^{\infty} \frac{\lambda^k}{k!} e^{-\lambda} = e^{\lambda} e^{-\lambda} = 1$.

In (b), for each $k \geq 0$, we have

$$\begin{aligned} p_{n,\lambda}(k) &= \binom{n}{k} \left(\frac{\lambda}{n}\right)^k \left(1 - \frac{\lambda}{n}\right)^{n-k} \\ &= \left[\frac{n(n-1)\dots(n-k+1)}{k!} \left(\frac{1/n}{1-\lambda/n}\right)^k \right] \lambda^k \left(1 - \frac{\lambda}{n}\right)^n. \end{aligned}$$

With k fixed and n tending to infinity, the factor in brackets tends to $\frac{1}{k!}$. Thus $\lim_n p_{n,\lambda}(k) = \frac{1}{k!} \lambda^k e^{-\lambda} = p_{\lambda}(k)$. The cumulative distribution function $F_{x_{n,\lambda}}$ of $x_{n,\lambda}$

at each point is the sum of certain values of $p_{n,\lambda}(k)$, and the cumulative distribution function of F_{x_λ} at that same point is the sum of the corresponding values of $p_\lambda(k)$. Therefore $\lim_n F_{x_{n,\lambda}} = F_{x_\lambda}$ pointwise. By definition $x_{n,\lambda}$ tends to x_λ in distribution.

In (c), the mean is λ , and the variance is λ . In fact, we have $E(x_\lambda) = \sum_k k \frac{\lambda^k}{k!} e^{-\lambda} = e^{-\lambda} \lambda \frac{d}{d\lambda} (\sum_k \frac{\lambda^k}{k!}) = e^{-\lambda} \lambda e^\lambda = \lambda$. Also

$$\begin{aligned} \text{Var}(x_\lambda) &= E(x_\lambda^2) - \lambda^2 = \sum k^2 \frac{\lambda^k}{k!} e^{-\lambda} - \lambda^2 \\ &= e^{-\lambda} \lambda^2 \sum (k(k-1) + k) \frac{\lambda^{k-2}}{k!} - \lambda^2 \\ &= e^{-\lambda} \lambda^2 \left(\frac{d^2}{d\lambda^2} e^\lambda \right) + e^{-\lambda} \lambda \left(\frac{d}{d\lambda} e^\lambda \right) - \lambda^2 = \lambda^2 + \lambda - \lambda^2 = \lambda. \end{aligned}$$

20. In (a), consider $u(s) = \log(1 + c/s)^s = s(\log(s+c) - \log s)$. This has derivative $u'(s) = \log(s+c) - \log s + s/(s+c) - s/s = \log(1+c/s) - c/(s+c)$. Since $u''(s) = 1/(s+c) - 1/s + c/(s+c)^2 = -c^2/(s(s+c)^2)$ is positive for $s > 0$, $u'(s)$ is a strictly decreasing function. By inspection, $\lim_{s \rightarrow +\infty} u'(s) = 0$. Thus $u'(s) > 0$ for all $s > 0$. We conclude that $u(s)$ is an increasing function for $s > 0$, and so is its exponential, which is $(1 + c/s)^s$.

In (b), we know that $\lim_{s \rightarrow +\infty} (1 + c/s)^s = e^c$, and (a) says that this is an increasing limit. Taking reciprocals shows that $\lim_{s \rightarrow +\infty} (1 + c/s)^{-s} = e^{-c}$, a decreasing limit. If we put $c = t^2/2$ and $s = (n-1)/2$, then we obtain

$$\lim_{n \rightarrow +\infty} \left(1 + \frac{t^2}{n-1}\right)^{(n-1)/2} = e^{-t^2/2},$$

a decreasing limit. The second statement follows because $(1 + \frac{t^2}{n-1})^{(n-1)/2} = c_n^{-1} f_n(t)$.

In (c), we see from (b) that for $n \geq 2$, $(1 + \frac{t^2}{n-1})^{-(n-1)/2}$ is dominated by the case $n = 2$, where the function is $(1 + t^2)^{-1/2}$. Multiplying by $(1 + t^2)^{-1/2}$, we see that $(1 + \frac{t^2}{n-1})^{-n/2} \leq (1 + t^2)^{-1}$ for $n \geq 2$. The function $(1 + t^2)^{-1}$ is integrable, and thus dominated convergence allows us to conclude that $\lim_n \int_{\mathbb{R}} (1 + \frac{t^2}{n-1})^{-n/2} dt = \int_{\mathbb{R}} \lim_n (1 + \frac{t^2}{n-1})^{-n/2} dt$. By (b), the right side equals $\int_{\mathbb{R}} e^{-t^2/2} dt$, which is $\sqrt{2\pi}$. Since $\int_{\mathbb{R}} f_n(t) dt = 1$ for all n , the left side is $\lim_n c_n^{-1}$. Thus $\lim_n c_n^{-1} = \sqrt{2\pi}$.

21. Because of the dominated convergence in the previous problem, $\int_a^b f_n(t) dt$ has limit $(2\pi)^{-1/2} e^{-t^2/2} dt$, and this is just the statement of the convergence in distribution.

22–23 and 25. The style of argument for these problems is all the same. In the case of Problem 22, we have

$$P(a < x + c < b) = P(a - c < x < b - c) = \int_{a-c}^{b-c} f(t) dt = \int_a^b f(s - c) ds,$$

and thus the probability distribution of $x + c$ is $f(t - x) dt$. Similarly in Problem 23 the probability distribution of cx is $c^{-1} f(c^{-1}t) dt$, and in Problem 25 the probability distribution of w_n is $\frac{1}{\sigma^2 \sqrt{2\pi}} e^{-t^2/(2\sigma^2)}$.

24. We are to consider $\frac{1}{\sigma^2\sqrt{2\pi}} e^{-(x-\mu)^2/(2\sigma^2)} * \frac{1}{\sigma'^2\sqrt{2\pi}} e^{-(x-\mu')^2/(2\sigma'^2)}$. If we write out the convolution of the two functions and complete the square in the exponent, we see that the result is a multiple of some quadratic exponential, hence is normal. The means have to add, and the independence implies that the variances have to add, by a computation in Section 4. Thus the probability distribution of the sum has to be $N(\mu + \mu', \sigma^2 + \sigma'^2)$.

26. The probability distribution of w_n is equal to $\frac{1}{\sigma^2\sqrt{2\pi}} e^{-t^2/(2\sigma^2)}$ for every n , and we are considering the limit of a constant sequence.

Chapter X

1. Examination of the proof shows that equality can fail only at one step, and that the inequality at that step holds by the Schwarz inequality. For two nonzero functions, equality holds in the Schwarz inequality if and only if the functions are proportional to one another. Therefore the condition is that $tf(t)$ is proportional to $f'(t)$, i.e., that $f'(t) = ktf(t)$ for some constant k . Solving, we get $f(t) = ce^{\frac{1}{2}kt^2}$. This function is in the Schwartz space if and only if $\text{Re } k < 0$.

2. The function $f_1(t) = t^{-1} \sin \pi t$ vanishes at every integer except 0, and the Fourier transform $\mathcal{F}f_1$ is supported in $[-\frac{1}{2}, \frac{1}{2}]$. If $f_2(t) = f_1(\frac{1}{2}t)$, then f_1 vanishes at every half integer except 0, and the Fourier transform is supported in $[-1, 1]$. Finally the function f_3 with $f_3(t) = f_2(t - \frac{1}{2})$ vanishes at every half integer except $\frac{1}{2}$, and the Fourier transform is supported in $[-1, 1]$. Thus f_3 has the required properties.

3. For (b), write $v(y) = \sum_{k=M}^N c_k e^{-2\pi iky}$ with $c_M \neq 0$ and $c_N \neq 0$. Then $1 = |v(y)|^2$ is a trigonometric polynomial of the form

$$\sum_{k=M}^N c_k e^{-2\pi iky} \sum_{j=M}^N \bar{c}_j e^{2\pi i jy} = \sum_{k=M}^N \sum_{l=-N}^{-M} c_k \bar{c}_{-l} e^{-2\pi i(k+l)y}.$$

The lowest order exponential that appears is $e^{-2\pi i(N-M)y}$, and it has coefficient $c_N \bar{c}_M \neq 0$. Since the exponentials are linearly independent, $N - M = 0$, and $v(y)$ is a multiple of a single exponential.

4. For (a), define $f^\#(x) = f(-x)$ for any function f on \mathbb{R} . Let V_j be the set of all $f^\#$ such that f is in V_j . Then $\varphi^\#$ and $\{V_j^\#\}$ form a multiresolution analysis.

Part (b) is routine.

For (c), the idea is that the Daubechies φ is constructed using a function $\mathcal{L}(y)$ built from all the roots within the unit disk of a certain polynomial Q , while $\varphi^\#$, apart from an integer translation, arises from the same construction with the corresponding

$\mathcal{L}(y)$ built from all the roots outside the unit disk. In more detail let $Q(z)$ be as in the construction of φ , and define

$$\mathcal{L}_1(y) = \prod_{|\alpha_j| < 1} (e^{-2\pi iy} - \alpha_j) \prod_{\beta_k} (e^{-2\pi iy} - \beta_k)^{m_k}.$$

We set $c_1 = \mathcal{L}_1(0)^{-1}$, and then $\mathcal{L}(y) = c_1 \mathcal{L}_1(y)$ is the function \mathcal{L} that appears in Proposition 10.34. For each factor of \mathcal{L}_1 , we have

$$(e^{2\pi iy} - \alpha) = \alpha e^{2\pi iy} (\alpha^{-1} - e^{-2\pi iy}) = -\alpha e^{2\pi iy} (e^{-2\pi iy} - \alpha^{-1}).$$

Taking the product of all the factors, we obtain

$$\mathcal{L}_1^\#(y) = c_2 e^{2\pi i p y} \prod_{|\alpha_j| > 1} (e^{-2\pi iy} - \alpha_j) \prod_{\beta_k} (e^{-2\pi iy} - \beta_k)^{m_k} \quad \text{with } c_2 \neq 0 \text{ and } p \in \mathbb{Z}.$$

Let $\mathcal{L}_2(y)$ be the product on the right, so that $\mathcal{L}_1^\#(y) = c_2 e^{2\pi i p y} \mathcal{L}_2(y)$. Now

$$m_0(y) = \left(\frac{1 + e^{-2\pi iy}}{2} \right)^N \mathcal{L}(y)$$

implies

$$\begin{aligned} m_0^\#(y) &= \left(\frac{1 + e^{2\pi iy}}{2} \right)^N \mathcal{L}^\#(y) \\ &= e^{2\pi i N y} \left(\frac{1 + e^{-2\pi iy}}{2} \right)^N \mathcal{L}^\#(y) \\ &= c_1 e^{2\pi i N y} \left(\frac{1 + e^{-2\pi iy}}{2} \right)^N \mathcal{L}_1^\#(y) \\ &= c_1 c_2 e^{2\pi i (N+p)y} \left(\frac{1 + e^{-2\pi iy}}{2} \right)^N \mathcal{L}_2(y). \end{aligned}$$

Form the h function that corresponds to $m_0^\#$. The exponential $e^{2\pi i (N+p)y}$ contributes exactly $e^{2\pi i (N+p)y}$ to the infinite product, and \mathcal{F}^{-1} carries the exponential to an integer translation. For the constants we have

$$1 = \mathcal{L}(0) = \mathcal{L}^\#(0) = c_1 \mathcal{L}_1^\#(0) = c_1 c_2 \mathcal{L}_2(0),$$

and this is the correct normalization to have in the \mathcal{L} part of the function $m_0^\#$. Consequently $\varphi^\#$ comes from the same construction as φ but with the roots α_j with $|\alpha_j| > 1$ in place of the roots α_j with $|\alpha_j| < 1$, possibly in combination with a translation by the integer $N + p$.

5. Let V_0 be the subspace of all functions in $L^2(\mathbb{R})$ that are a.e. constant on each interval $[n - \frac{2}{3}, n + \frac{1}{3})$ for $n \in \mathbb{Z}$. Then the integer translates of φ form an orthonormal basis of V_0 . We obtain V_j by dilation from V_0 as usual, and the resulting sequence $\{V_j\}_{j \in \mathbb{Z}}$ of spaces forms a multiresolution analysis with φ .

6. For (a), we have $m_0(y) = \frac{1}{2}(1 + e^{4\pi y}) = e^{-2\pi iy} \cos 2\pi y$ and

$$\begin{aligned} 2^n \sin(2\pi y/2^n) \prod_{j=1}^n m_0(2^{-j}y) &= 2^n e^{-2\pi iy(\frac{1}{2} + \dots + \frac{1}{2^n})} \left(\prod_{j=1}^n \cos(2\pi y/2^j) \right) \sin(2\pi y/2^n) \\ &= 2^{n-1} e^{-2\pi iy(\frac{1}{2} + \dots + \frac{1}{2^n})} \left(\prod_{j=1}^{n-1} \cos(2\pi y/2^j) \right) \sin(2\pi y/2^{n-1}) \\ &= \dots = 2e^{-2\pi iy(\frac{1}{2} + \dots + \frac{1}{2^n})} \cos(2\pi y/2) \sin(2\pi y/2) \\ &= e^{-2\pi iy(\frac{1}{2} + \dots + \frac{1}{2^n})} \sin(2\pi y). \end{aligned}$$

Therefore

$$\frac{\sin(2\pi y/2^n)}{2\pi y/2^n} \prod_{j=1}^n m_0(2^{-j}y) = e^{-2\pi iy(\frac{1}{2} + \dots + \frac{1}{2^n})} \left(\frac{\sin 2\pi y}{2\pi y} \right).$$

Letting n tend to infinity shows that

$$h(y) = e^{-2\pi iy} \left(\frac{\sin 2\pi y}{2\pi} \right) = \frac{e^{-2\pi iy}}{2i(2\pi)} (e^{2\pi iy} - e^{-2\pi iy}) = \frac{1 - e^{-4\pi iy}}{4\pi iy} = (\mathcal{F}I_{[0,2]})(y).$$

Thus $\varphi(x) = I_{[0,2]}(x)$.

For (b), $\varphi(x)$ and $\varphi(x-1)$ are not orthogonal, since they are ≥ 0 and their supports overlap. Hypothesis (iii) is not satisfied, since $\frac{1}{2}(1 + e^{4\pi y})$ is not > 0 for $|y| \leq \frac{1}{4}$, merely ≥ 0 .

7. $P_m f$ is meaningful for f in $L^1(\mathbb{R})$ by Proposition 10.5. The formula is

$$P_m f(x) = |I_{m,k}|^{-1} \int_{I_{m,k}} f(y) dy \quad \text{for } x \in I_{m,k}.$$

Thus

$$\int_{I_{m,k}} |P_m f(x)| dx = |I_{m,k}| |I_{m,k}|^{-1} \left| \int_{I_{m,k}} f(y) dy \right| \leq \int_{I_{m,k}} |f(y)| dy.$$

Summing on k , we obtain

$$\int_{\mathbb{R}} |P_m f(x)| dx \leq \int_{\mathbb{R}} |f(y)| dy,$$

i.e., $\|P_m f\|_1 \leq \|f\|_1$. To prove the convergence in L^1 , we observe from Corollary 10.7 that $P_m g$ tends to g uniformly if g is in $C_{\text{com}}(\mathbb{R})$. Since the convergence all takes place within a compact set, $P_m g$ tends to g in $L^1(\mathbb{R})$. Given $f \in L^1(\mathbb{R})$ and $\epsilon > 0$, choose $g \in C_{\text{com}}(\mathbb{R})$ with $\|g - f\|_1 < \epsilon/3$. If m is taken large enough so that $\|P_m g - g\|_1 < \epsilon/3$, then

$$\begin{aligned} \|P_m f - f\|_1 &\leq \|P_m f - P_m g\|_1 + \|P_m g - g\|_1 + \|g - f\|_1 \\ &\leq 2\|f - g\|_1 + \|P_m g - g\|_1 \\ &\leq 2\epsilon/3 + \|P_m g - g\|_1 < \epsilon. \end{aligned}$$

8. From the first formula in the solution of Problem 7, we have $\int_{I_{m,k}} P_m f(x) dx = \int_{I_{m,k}} f(x) dx$. Summing on k then gives $\int_{\mathbb{R}} P_m f(x) dx = \int_{\mathbb{R}} f(x) dx$. Thus the continuous linear functional $\ell(f) = \int_{\mathbb{R}} f(x) dx$ on $L^1(\mathbb{R})$ has the property that $\ell(P_m f) = \ell(f)$. If f is a function in $L^1(\mathbb{R})$ for which $P_m f$ tends to 0 in $L^1(\mathbb{R})$, then the continuity of ℓ says we must have $\lim_m \ell(P_m f) = 0$ and hence $\ell(f) = 0$. Since $\ell(f) \neq 0$ for $f = I_{[0,1]}$, $\lim_{m \rightarrow -\infty} P_m f$ cannot be 0 for $f = I_{[0,1]}$.

9. The value of $P_m f(\frac{1}{3})$ for this f is $2^m |I_{m,k} \cap [0, \frac{1}{3}]|$, where

$$I_{m,k} = \{y \in \mathbb{R} \mid k \leq 2^m y < k + 1\},$$

and $\frac{1}{3}$ is to be in $I_{m,k}$. The binary expansion of $\frac{1}{3}$ comes from the geometric series $\frac{1}{3} = \frac{1}{4} + \frac{1}{4^2} + \frac{1}{4^3} + \dots$, and the sets $I_{m,k}$ containing $\frac{1}{3}$ are determined as follows. If $m = 2r$ is even, then $k \leq 4^r/3 < k + 1$ for $k = 4^r(\frac{1}{4} + \frac{1}{4^2} + \dots + \frac{1}{4^r})$. The y 's that are in $I_{m,k}$ are the ones with $k \leq 4^r y < k + 1$, the smallest of which is $4^{-r}k$, i.e., $y = \frac{1}{4} + \frac{1}{4^2} + \dots + \frac{1}{4^r}$. The interval of such y 's is to be intersected with $[0, \frac{1}{3})$, and the measure of the result is $\frac{1}{3} - (\frac{1}{4} + \frac{1}{4^2} + \dots + \frac{1}{4^r}) = \frac{1}{3} - \frac{1-4^{-r}}{3} = 4^{-r}/3$. The normalization by the factor 2^m in the formula for $P_m f(\frac{1}{3})$ then yields $1/3$. So the value of $P_m f(\frac{1}{3})$ is $\frac{1}{3}$ for every even m . A similar computation for odd m gives $\frac{2}{3}$. Therefore

$$\liminf P_m(\frac{1}{3}) = \frac{1}{3} < \frac{2}{3} = \limsup P_m(\frac{1}{3}).$$

10. Let f be in $L^2(\mathbb{R})$ with support in $[0, 1]$. We can write out the one-sided Haar series expansion of f as

$$f(x) = \sum_{k \in \mathbb{Z}} \left(\int_{\mathbb{R}} f(y) \overline{\varphi_{0,k}(y)} dy \right) \varphi_{0,k}(x) + \sum_{j=0}^{\infty} \sum_{k \in \mathbb{Z}} \left(\int_{\mathbb{R}} f(y) \overline{\psi_{j,k}(y)} dy \right) \psi_{j,k}(x).$$

In the first term, $\int_{\mathbb{R}} f(y) \overline{\varphi_{0,k}(y)} dy = 0$ for $k \neq 0$, since f is supported in $[0, 1]$. In the second term, $\int_{\mathbb{R}} f(y) \overline{\psi_{j,k}(y)} dy = 0$ unless $\psi_{j,k}$ is supported in $[0, 1]$. The result is that

$$f(x) = \left(\int_{\mathbb{R}} \overline{\varphi(y)} dy \right) \varphi(x) + \sum_{\substack{j \geq 0, k \in \mathbb{Z}, \\ \psi_{j,k} \text{ supported in } [0,1]}} \left(\int_{\mathbb{R}} \overline{\psi_{j,k}(y)} dy \right) \psi_{j,k}(x).$$

This proves that every member of $L^2([0, 1])$ is a limit of linear combinations of the stated restrictions of functions. The restrictions are orthonormal as well, and hence they form an orthonormal basis.

11. Let $f(x) = f(2x) + f(2x - 1)$, and let $\widehat{f} = \mathcal{F}f$. Taking Fourier transforms, we get

$$\begin{aligned}\widehat{f}(y) &= \int_{\mathbb{R}} f(2x)e^{-2\pi ixy} dx + \int_{\mathbb{R}} f(2x - 1)e^{-2\pi ixy} dx \\ &= \frac{1}{2} \int_{\mathbb{R}} f(x)e^{-2\pi ix\frac{1}{2}y} dx + \frac{1}{2} \int_{\mathbb{R}} f(x)e^{-2\pi i(x+1)\frac{1}{2}y} dx \\ &= \frac{1}{2} \widehat{f}\left(\frac{1}{2}y\right) + \frac{1}{2} e^{-\pi iy} \widehat{f}\left(\frac{1}{2}y\right) \\ &= \frac{1}{2} (1 + e^{-\pi iy}) \widehat{f}\left(\frac{1}{2}y\right) \\ &= \frac{1}{4} (1 + e^{-\pi iy})(1 + e^{-\pi iy/2}) \widehat{f}\left(\frac{1}{4}y\right) \\ &= \dots \\ &= e^{-\pi iy/2} \cos(\pi y/2) e^{-\pi iy/4} \cos(\pi y/4) \dots e^{-\pi iy/2^n} \cos(\pi y/2^n) \widehat{f}(2^{-n}y).\end{aligned}$$

Thus

$$\begin{aligned}\widehat{f}(y) \sin(\pi y/2^n) &= e^{-\pi iy/2} \dots e^{-\pi iy/2^n} \cos(\pi y/2) \cos(\pi y/4) \dots \cos(\pi y/2^{n-1}) \sin(\pi y/2^{n-1}) \frac{1}{2} \\ &\quad \times \widehat{f}(2^{-n}y) \\ &= e^{-\pi iy(\frac{1}{2} + \frac{1}{4} + \dots + \frac{1}{2^n})} \cos(\pi y/2) \sin(\pi y/2) \frac{1}{2^{n-1}} \widehat{f}(2^{-n}y),\end{aligned}$$

and we obtain

$$\widehat{f}(y) \frac{\sin(\pi y 2^{-n})}{2^{-n}} = e^{-\pi iy(\frac{1}{2} + \frac{1}{4} + \dots + \frac{1}{2^n})} \sin(\pi y) \widehat{f}(2^{-n}y).$$

Dividing both sides by πy , we let n tend to infinity with y fixed, and the result is

$$\widehat{f}(y) = \frac{e^{-\pi iy} \sin(\pi y)}{\pi y} \widehat{f}(0),$$

since \widehat{f} is continuous at 0. We can rewrite this equality as

$$\widehat{f}(y) = \frac{1 - e^{-2\pi iy}}{2\pi iy} \widehat{f}(0) = (\mathcal{F}I_{[0,1]})(y) \widehat{f}(0).$$

Therefore we can conclude that f is a multiple of $I_{[0,1]}$.

12. Taking the inner product of both sides with $\Phi(2x - n)$ and using the orthogonality of the functions $\Phi(2x - k)$ for $k \in \mathbb{Z}$, we obtain

$$\int \Phi(x)\Phi(2x - n) dx = a_n \int_{\mathbb{R}} \Phi(2x - n)^2 dx = \frac{1}{2}a_n \int_{\mathbb{R}} \Phi(x)^2 dx = \frac{1}{2}a_n.$$

So

$$a_n = 2 \int_{\mathbb{R}} \Phi(x)\Phi(2x - n) dx = 2 \int_{-1/2}^{1/2} \Phi(2x - n) dx = \int_{-1}^1 \Phi(x - n) dx.$$

We conclude that $a_0 = 1$ and $a_{-1} = a_1 = \frac{1}{2}$. The given identity thus has to be

$$\Phi(x) = \Phi(2x) + \frac{1}{2}\Phi(2x - 1) + \frac{1}{2}\Phi(2x + 1).$$

For $\frac{1}{2} < x < \frac{3}{4}$, the left side is 0 while the right side is $0 + \frac{1}{2} + 0 = \frac{1}{2}$, contradiction.

13. Since ν is of class C^m , the derivatives of P must match those of ν through order m at $x = 0$ and $x = 1$. Then $P^{(k)}(0) = 0$ for $0 \leq k \leq m$, $P(1) = 1$, and $P^{(k)}(1) = 0$ for $1 \leq k \leq m$. The first of these conditions says that $P(x)$ is divisible by x^{m+1} . Thus P is admissible.

14. The difference of two admissible polynomials is divisible by x^{m+1} and $(x-1)^m$, hence by $x^m(x-1)^m$. Thus it has degree $\geq 2m + 2$. This proves uniqueness of admissible polynomials of degree $\leq 2m + 1$. If P is admissible, then the Euclidean algorithm allows us to write $P(x) = A(x)x^{m+1}(x-1)^{m+1} + B(x)$ with $B = 0$ or $\deg B \leq 2m + 1$, and B will be admissible. This proves existence of admissible polynomials of degree $\leq 2m + 1$ under the assumption that an admissible polynomial of some degree exists.

15. If $P(x)$ is admissible, then so is $1 - P(1 - x)$. The uniqueness in Problem 14 forces $P(x) + P(1 - x) = 1$.

16. For (a), the Binomial Theorem gives

$$\begin{aligned} (1 - z)^{m+1} &= \sum_{k=0}^{m+1} (-1)^k \binom{m+1}{k} z^k \\ &= \sum_{k=0}^p (-1)^k \binom{m+1}{k} z^k + [z^{p+1}] \\ &= \sum_{q=0}^p (-1)^{p-q} \binom{m+1}{p-q} z^{p-q} + [z^{p+1}], \end{aligned}$$

the last equality following after the change of indices $k = p - q$.

For (b), let $D = \frac{d}{dz}$. The binomial series, convergent for $|z| < 1$, is

$$\begin{aligned} (1 - z)^{-(m+1)} &= \sum_{k=0}^{\infty} \frac{1}{k!} (D^k(1 - z)^{-(m+1)})(0)z^k \\ &= 1 + \sum_{k=1}^{\infty} \frac{1}{k!} (m+1)(m+2)\cdots(m+k)z^k \\ &= \sum_{k=0}^{\infty} \binom{m+k}{k} z^k, \end{aligned}$$

and the conclusion follows.

For (c), we multiply the results of (a) and (b) and obtain

$$\begin{aligned} 1 &= (1-z)^{m+1}(1-z)^{-(m+1)} \\ &= \left(\sum_{l=0}^p (-1)^{p-l} \binom{m+1}{p-l} z^{p-l} \right) \left(\sum_{k=0}^p \binom{m+k}{k} z^k \right) + [z^{p+1}]. \end{aligned}$$

Equating the coefficients of z^p on the two sides of the equation gives the desired result, since the z^p term in the product arises exactly when $k = l$.

17. For (a), we set $f(x) = x^{m+1}$ and $g(x) = \sum_{k=0}^m \binom{m+k}{k} (1-x)^k$. Then we have

$$D^p P(x) = \sum_{q=0}^p D^{p-q}(x^{m+1}) D^q g(x)$$

with

$$\begin{aligned} D^{p-q}(x^{m+1}) &= (m+1)(m)(m-1)\cdots(m-p+q+2)x^{m+1-p+q} \\ D^{p-q}(x^{m+1})(1) &= \frac{(m+1)!}{(m-p+q+1)!} \\ D^q g(x) &= \sum_{k=0}^m (-1)^q k(k-1)\cdots(k-q+1)(1-x)^{k-q} \\ D^q g(1) &= \binom{m+q}{q} q! (-1)^q. \end{aligned}$$

So

$$\begin{aligned} D^p P(1) &= \sum_{q=0}^p \binom{p}{q} \frac{(m+1)!}{(m-p+q+1)!} \binom{m+q}{q} (-1)^q q! \\ &= \sum_{q=0}^p \frac{p!}{q!(p-q)!} \binom{m+1}{p-q} (p-q)! \binom{m+q}{q} q! (-1)^q \\ &= p! \sum_{q=0}^p (-1)^q \binom{m+1}{p-q} \binom{m+q}{q}. \end{aligned}$$

For (b), we compute $P(1)$ from (a) with $p = 0$ and obtain $P(1) = 0! \binom{m+1}{0} \binom{m+0}{0} = 1$. We compute $P^{(p)}(1)$ for $1 \leq p \leq m$ from (a) with $p > 0$ and obtain

$$\begin{aligned} P^{(p)}(1) &= p! \sum_{q=0}^p (-1)^q \binom{m+1}{p-q} \binom{m+q}{q} \\ &= (-1)^p p! \left(\sum_{q=0}^p (-1)^{p-q} \binom{m+1}{p-q} \binom{m+q}{q} \right). \end{aligned}$$

The sum in parentheses on the right side is 0 by Problem 16c, and thus $P^{(p)}(1) = 0$ for $p > 0$. The polynomial P is manifestly divisible by x^{m+1} , and thus it is admissible. Since P has degree $2m+1$, Problems 14 and 15 show that P is usable as the polynomial in the definition of the Meyer wavelet of index m .

18. It is enough to treat the scaling function φ , since the wavelet equation shows that ψ is a linear combination of the functions $\varphi_{1,k}$. We have

$$\|\varphi\|_{H^s}^2 = \int_{|y| \leq 1} |(\mathcal{F}\varphi)(y)|^2 (1+y^2)^s dy + \sum_{j=1}^{\infty} \int_{2^{j-1} \leq |y| \leq 2^j} |(\mathcal{F}\varphi)(y)|^2 (1+y^2)^s dy.$$

Since $(1+y^2)^s \leq 2^s$ for $|y| \leq 1$, the first term on the right side is $\leq 2^s \int_{\mathbb{R}} |\mathcal{F}\varphi|^2 dy$ and is harmless. The sum on the right side is

$$\leq \sum_{j=1}^{\infty} 2^j \left(\frac{2^{N-1}}{\sqrt{\pi N}} \right) (\sqrt{4\pi N})^{-j} (1+2^{2j})^s,$$

and this is finite by the ratio test if the equal quantities

$$\sum_{j=1}^{\infty} 2^j (\sqrt{4\pi N})^{-j} 2^{2sj} = \sum_{j=1}^{\infty} (\sqrt{\pi N})^{-j} (4^s)^j$$

are finite, and in turn these quantities are finite if $4^s < \sqrt{\pi N}$. Taking \log_2 of both sides shows that a sufficient condition for finiteness is that $s < \frac{1}{4} \log_2(\pi N)$, as required.

19. Problem 12c from Chapter III says that the members of $H^s(\mathbb{R})$ are of class C^m if $s > \frac{1}{2} + m$. Thus we want $\frac{1}{2} + m < \frac{1}{4} \log_2(\pi N)$ or

$$m < \frac{1}{4} \log_2(\pi N) - \frac{1}{2} = \frac{1}{4} (\log_2(\pi N) - \log_2 4) = \frac{1}{4} \log_2(\pi N/4).$$

SELECTED REFERENCES

- Adams, M., and V. Guillemin, *Measure Theory and Probability*, Wadsworth & Brooks/Cole Advanced Books and Software, Monterey, CA 1986; corrected reprint of the original, Birkhäuser Boston, Inc., Boston, 1996.
- Ahlfors, L. V., *Lectures on Quasiconformal Mappings*, D. Van Nostrand Company, Inc., Toronto, 1966; reprinted, Wadsworth Brooks/Cole Advanced Books and Software, Monterey, CA, 1987.
- Austin, D., Image compression: seeing what's not there, feature column, American Mathematical Society, September 2007, <http://www.ams.org/samplings/feature-column/fcarc-image-compression>.
- Austin, D., What is JPEG?, *Notices of the American Mathematical Society* 55 (2008), 226–229.
- Bailey, B. A., Lecture Notes on Multivariate Statistics, Summer 2009, downloaded from <http://www-rohan.sdsu.edu/~babailey/reut09>. Lectures 9 and 11 (Chapter 6) are relevant to the present Chapter IX.
- Bers, L., F. John, and M. Schechter, *Partial Differential Equations*, Interscience Publishers, Inc., New York, 1964; reprinted, American Mathematical Society, Providence, 1979.
- Brislaw, C. M., Fingerprints go digital, *Notices of the American Mathematical Society* 42 (1995), 1278–1295.
- Burris, C. S., R. A. Gopinath, and H. Guo, *Introduction to Wavelets and Wavelet Transforms, a Primer*, Prentice-Hall, Upper Saddle River, NJ, 1998.
- Cartan, É., Sur la détermination d'un système orthogonal complet dans un espace de Riemann symétrique clos, *Rend. Circ. Mat. Palermo* 53 (1929), 217–252.
- Chui, C. K., *An Introduction to Wavelets*, Academic Press, Inc., Boston, 1992.
- Churchill, R. V., *Fourier Series and Boundary Value Problems*, McGraw–Hill Book Company, New York, 1941; second edition 1963.
- Coddington, E. A., and N. Levinson, *Theory of Ordinary Differential Equations*, McGraw–Hill Book Company, New York, 1955.
- Courant, R., and D. Hilbert, *Methods of Mathematical Physics*, John Wiley & Sons, New York. Vol. I, 1953, reprinted, 1989; Vol. II, *Partial Differential Equations*, 1962, reprinted, 1989.
- Daubechies, I., *Ten Lectures on Wavelets*, Society for Industrial and Applied Mathematics, Philadelphia, 1992.
- Debnath, L., *Wavelet Transforms and Their Applications*, Birkhäuser Boston, Inc., Boston, 2002.

- Doob, J. L., *Measure Theory*, Springer-Verlag, New York, 1994.
- Duistermaat, J. J., and J. A. C. Kolk, *Multidimensional Real Analysis*, Cambridge University Press, Cambridge, 2004. Vol. I, *Differentiation*; Vol. II, *Integration*.
- Dunford, N., and J. T. Schwartz, *Linear Operators*, Interscience Publishers, Inc., New York, Part 1, *General Theory*, 1958; Part 2, *Spectral Theory*, 1963; Part 3 *Spectral Operators*, 1971.
- Elkies, N.D., One of the answers to a question about central binomial coefficients, <http://mathoverflow.net/questions/133732/upper-limit-on-the-central-binomial-coefficient>.
- Feller, W., *An Introduction to Probability Theory and Its Applications*, Vol. II, John Wiley & Sons, New York, 1966; second edition, 1971.
- Friedman, A., *Partial Differential Equations*, Holt, Rinehart and Winston, New York, 1969.
- Gelfand, I. M., and G. E. Shilov, *Generalized Functions*, Academic Press, New York. Vol. 1, *Properties and Operations*, 1964; Vol. 2, *Spaces of Fundamental and Generalized Functions*, 1968; Vol. 3, *Theory of Differential Equations*, 1967. All reprinted, 1977.
- Gelfand, I. M., and N. Ya. Vilenkin, *Generalized Functions*, Academic Press, New York. Vol. 4, *Applications of Harmonic Analysis*, 1964. Reprinted, 1977.
- Gelfand, I. M., M. I. Graev, and N. Ya. Vilenkin, *Generalized Functions*, Academic Press, New York. Vol. 5, *Integral Geometry and Representation Theory*, 1966. Reprinted, 1977.
- Halmos, P. R., *Introduction to Hilbert Space*, Chelsea Publishing Company, New York, 1951; second edition, 1957.
- Halmos, P. R., *Measure Theory*, D. Van Nostrand Company, Inc., Princeton, 1950; reprinted, Springer-Verlag, New York, 1974.
- Hernandez, E., and G. Weiss, *A First Course on Wavelets*, CRC Press, Inc., Boca Raton, FL, 1996.
- Hoffman, K., *Banach Spaces of Analytic Functions*, Prentice-Hall, Inc., Englewood Cliffs, NJ, 1962.
- Hörmander, L., *The Analysis of Linear Partial Differential Operators*, Springer-Verlag, Berlin. Vol. I, *Distribution Theory and Fourier Analysis*, 1983; Vol. II, *Differential Operators with Constant Coefficients*, 1983; Vol. III, *Pseudo-differential Operators*, 1985; Vol. IV, *Fourier Integral Operators*, 1985.
- Hubbard, B. B., *The World According to Wavelets*, A.K. Peters, Ltd., Wellesley, MA, 1996; second Edition 1998.
- Ince, E. L., *Ordinary Differential Equations*, Longmans, Green and Co., London, 1927; reprinted, Dover Publications, New York, 1944.
- Kelley, J. L., *General Topology*, D. Van Nostrand Company, Inc., Princeton, 1955; reprinted, Springer-Verlag, New York, 1975.
- Kelley, J. L., I. Namioka, et al., *Linear Topological Spaces*, D. Van Nostrand Company, Inc., Princeton, 1963.
- Knapp, A. W., *Elliptic Curves*, Princeton University Press, Princeton, 1992.

- Knapp, A. W., *Basic Real Analysis*, Birkhäuser, Boston, 2005; digital second edition, 2016.
- Knapp, A. W., *Basic Algebra*, Birkhäuser, Boston, 2006; digital second edition, 2016.
- Kolmogorov, A. N., *Foundations of the Theory of Probability*, Chelsea Publishing Company, 1950; second English edition, 1956. Original German edition published 1933.
- Lawson, H. B., and M.-L. Michelsohn, *Spin Geometry*, Princeton University Press, Princeton, 1989.
- Lax, P. D., *Partial Differential Equations*, Notes by J. Berkowitz and A. and P. Lax, 1950–1951, New York University, Courant Institute of Mathematical Sciences.
- Lebanon, G., *The Analysis of Data Project*, downloaded as of January 2015 from <http://www.theanalysisofdata.com>. The project advertises itself as featuring “comprehensive coverage of all relevant disciplines including probability, statistics, computing, and machine learning.” Chapter 8 of Volume I is relevant to the present Chapter IX.
- Lewy, H., An example of a smooth linear partial differential equation without solution, *Annals of Math.* 66 (1957), 155–158.
- Liouville, J., Sur le développement des fonctions ou parties de fonctions en séries dont les divers termes sont assujettis à satisfaire à une même équation différentielle du second ordre contenant un paramètre variable II, *Journal de Mathématiques Pures et Appliquées* 2 (1837), 16–35.
- Loomis, L. H., *An Introduction to Abstract Harmonic Analysis*, D. Van Nostrand Company, Inc., New York, 1953.
- Louis, A. K., P. Maass, and A. Rieder, *Wavelets, Theory and Applications*, Pure and Applied Mathematics, John Wiley and Sons, Chichester, 1997.
- Meyer, Y., *Wavelets and Operators*, Cambridge University Press, Cambridge, 1992.
- Munroe, M. E., *Introduction to Measure and Integration*, Addison–Wesley Publishing Company, Inc., Cambridge, MA, 1953; second edition, *Measure and Integration*, Addison–Wesley Publishing Company, Reading, MA, 1971.
- Naimark, M. A., *Normed Rings*, P. Noordhoff, Groningen, Netherlands, 1964.
- Pierce, L. B., *Hardy Functions*, Junior Paper written under the direction of E. M. Stein, Princeton University, Princeton, May 2001, downloaded as of July 2016 from http://www.math.ias.edu/~lbpierce/theses/Pierce_Junior_Paper.pdf.
- Pinsky, M. A., *Introduction to Fourier Analysis and Wavelets*, American Mathematical Society, Providence, RI, 2002.
- Rabbani, M., and R. Joshi, An overview of the JPEG 2000 still image compression standard, *Signal Processing: Image Communication* 17 (2002), 3–48.
- Riesz, F., and B. Sz.-Nagy, *Functional Analysis*, Frederick Ungar Publishing Co., New York, 1955.
- Royden, H. L., *Real Analysis*, The Macmillan Company, New York, 1963; second edition, Macmillan Publishing Co., 1968, third edition, 1988.

- Rudin, W., *Real & Complex Analysis*, McGraw–Hill Book Company, New York, 1966; second edition 1974, third edition 1987.
- Saks, S., *Theory of the Integral*, second revised edition, G. E. Stechart and Company, New York, 1937; reprinted, Hafner Publishing Company, New York, no date, and Dover Publications, New York, 1964.
- Schwartz, L., *Théorie des Distributions*, Hermann, Paris, 1966.
- Sokolnikoff, I. S., and R. M. Redheffer, *Mathematics of Physics and Modern Engineering*, McGraw–Hill Book Company, New York, 1958; second edition 1966.
- Spivak, M., *Calculus on Manifolds*, Benjamin/Cummings Publishing Company, Menlo Park, CA, 1965.
- Steenrod, N., *The Topology of Fibre Bundles*, Princeton University Press, Princeton, 1951; reprinted, 1967.
- Stein, E. M., *Singular Integrals and Differentiability Properties of Functions*, Princeton University Press, Princeton, 1970.
- Stein, E. M., and G. Weiss, *Introduction to Fourier Analysis on Euclidean Spaces*, Princeton University Press, Princeton, 1971.
- Stein, E. M., *Harmonic Analysis: Real-Variable Methods, Orthogonality, and Oscillatory Integrals*, Princeton University Press, Princeton, 1993.
- Sturm, C., Sur les équations différentielles linéaires du second ordre, *Journal de Mathématiques Pures et Appliquées* 1 (1836), 106–186.
- Taylor, M. E., *Pseudodifferential Operators*, Princeton University Press, Princeton, 1981.
- Treves, F., *Basic Linear Partial Differential Equations*, Academic Press, Orlando, 1975.
- Treves, F., *Introduction to Pseudodifferential and Fourier Integral Operators*, Plenum Press, New York, 1980. Vol. 1, *Pseudodifferential Operators*; Vol. 2, *Fourier Integral Operators*.
- Treves, F., *Topological Vector Spaces, Distributions and Kernels*, Academic Press, New York, 1967.
- Wallace, G. K., The JPEG still picture compression standard, *IEEE Transactions on Consumer Electronics* 38 (1992), xviii–xxxiv.
- Weil, A., *L'intégration dans les Groupes Topologiques et Ses Applications*, Actuelles Scientifiques et Industrielles, vol. 869, Hermann, Paris, 1940; second edition, vol. 1145, 1965.
- Wells, R. O., *Differential Analysis on Complex Manifolds*, Prentice–Hall, Inc., Englewood Cliffs, NJ, 1973; second edition, Springer-Verlag, New York, 1980.

INDEX OF NOTATION

See also the list of Notation and Terminology on pages xix–xxii. In the list below, items are alphabetized according to their key symbols. For letters the order is lower case, italic upper case, Roman upper case, script upper case, blackboard bold, and Gothic. Next come items whose key symbol is Greek, and then come items whose key symbol is a nonletter. The last of these are grouped by type.

- | | |
|--|--|
| \widehat{a} , 153
\mathcal{A}_m^* , 153
$\mathbb{A}_{\mathbb{Q}}$, 271
$(\cdot)^c$, 266
c_k , 96
$C^\infty(E, \mathbb{C})$, $C^\infty(E, \mathbb{R})$, 324
$C_{\text{com}}^\infty(U)$, 131
$C_{\text{com}}^+(G)$, 226
C_K^∞ , 180
$\mathcal{C}_p(M)$, 327
\mathcal{C}_p^0 , \mathcal{C}_p^1 , 345
d , 368
$d^{(\alpha)}$, 250
dx , 237
$d_l x$, $d_r x$, 230
$(dF)_p$, dF_p , $dF(p)$, 330
D_j , 55
D^α , 55
$P(D)$, 284
$P(x, D)$, 185
$Q(D)$, 55
$\mathcal{D}'(M)$, 352
$\mathcal{D}'(U)$, 180
E_τ , 260
$E(x)$, 379
$\mathcal{E}'(M)$, 352
$\mathcal{E}'(U)$, 114
F_x , 380 | \mathcal{A}_F , P_F , 393
\mathcal{F} , 436
gf , fg , 222
gx , xg , 222
$g\mu$, μg , 222
$g_{\kappa'/\kappa}(\cdot)$, 338
$g_\kappa(x)$, 351
G^{tr} , 355
G_κ , 362
G/H , 214
$GL(N, \mathbb{C})$, 213
$GL(N, \mathbb{F})$, 338
$GL(N, \mathbb{R})$, 213, 223, 371
$GL_{\mathbb{C}}(V)$, 241
\mathcal{G} , 310, 357, 361
H^s , 63, 100
H_K^s , 366
$H_{\text{com}}^s(M)$, $H_{\text{loc}}^s(M)$, 366
aH , 214
G/H , 214
$H_n(x)$, 32
$H(f, \varphi)$, 226
$H^p(\mathbb{R}_+^2)$, 101
\mathcal{H} , 236
$\mathcal{H}^p(\mathbb{R}_+^{N+1})$, 81
J_m , 242, 490
$J_n(r)$, 12
l , 256 |
|--|--|

- ℓ_φ , 227
 L , 501
 $L(u)$, 19
 $L^*(v)$, 20
 $L^p([0, 1])$, $0 < p < 1$, 109
 $L^p(G)$, 237
 $L_k^2(T^N)$, 103
 $L_k^p(U)$, 63
 $L_{\text{com}}^1(M, \mu_g)$, $L_{\text{loc}}^1(M, \mu_g)$, 352
 $LAP(G)$, 272
 \mathcal{L} , 500
 m_0 , 455
 m_1 , 456
 M_κ , \tilde{M}_κ , 322
 $\mathcal{M}(L^2(S, \mu))$, 160
 $N(\mu, \sigma^2)$, 413
 $O(N)$, 218
 $p'(x, dy)$, 392
 P , 377
 $P(D)$, 284
 $P(x, D)$, 185
 $P(x, t)$, $P_t(x)$, 80
 $P(x, 2\pi i\xi)$, 287
 P_j , 470
 $P_m(x, 2\pi i\xi)$, 287
 $P_m(t)$, 16
 $P_r(\theta)$, 15
 P_N , 501
 $Q(D)$, 55
 \mathbb{Q}_p , 270
 r , 257
 $r(a)$, 150
 $R(\lambda)$, 150
 \mathbb{R}_+^{N+1} , 80
 $s(\omega)$, 420
 $\text{sgn } \sigma$, 242
 $\text{sing supp } u$, 303
 $\text{support}(\cdot)$, 192
 $S_{1,0}^m(U)$, $S_{1,0}^{-\infty}(U)$, 307
 $S_{1,0,0}^m(U \times U)$, $S_{1,0,0}^{-\infty}(U \times U)$, 356
 $SL(2, \mathbb{R})$, 236, 268
 $SL(N, \mathbb{F})$, 218
 $SO(N)$, 218, 264
 $Sp(N, \mathbb{F})$, 218
 $SU(2)$, 268
 $\mathcal{S}'(\mathbb{R}^N)$, 59
 \mathfrak{S}_n , 242
 $t(\omega)$, 420
 $(\cdot)^{\text{tr}}$, 188
 T^N , 102
 T_f , 187, 352
 $T(M)$, 331, 344
 $T(M, \mathbb{R})$, $T(M, \mathbb{C})$, 344
 $T^*(M)$, 344, 345
 $T^*(M, \mathbb{R})$, 355
 $T^*(M, \mathbb{R})^\times$, 364
 $T_p(M)$, 328
 $T_p^*(M)$, 345
 $\text{Tr } L$, 51, 249
 u_{xt} , 2
 aU , Ub , 213
 UV , U^{-1} , 213
 $U(N)$, 218
 V_0 , 454
 $\{V_j\}_{j=-\infty}^\infty$, 454
 $\bar{x}(\omega)$, 420
 $x_j(q)$, 323
 dx , 237
 φ_x , 190
 \mathbb{Z}^N , 292
 \mathbb{Z}_p , 270
Greek
 $|\alpha|$, 55
 $\alpha!$, 55
 D^α , 55
 ${}^1\gamma$, 477
 ${}^m\gamma$, 488
 ${}^m\gamma_{0,k}$, 482
 $\Gamma(x)$, 420
 δ , 206
 δg , 489

Δ , 2, 276, 480
 $\Delta(g)$, 230
 Δ_{2m} , 493
 $\Delta_G(t)$, 232
 εh , 489
 $\kappa : M_\kappa \rightarrow \tilde{M}_\kappa$, 322
 $d\mu(gH)$, 235
 μ_g , 351
 μ_x , 379
 μ_{x_1, \dots, x_N} , 381
 ν , 472
 π , 338
 $[-\pi, \pi]^N$, 292
 $\sigma(a)$, 150
 $\sigma_L(p, \xi)$, 355
 $\sigma_\kappa(x, \xi)$, 364
 φ , 454
 $\varphi_{j,k}$, 454
 φ_x , 190, 409
 ϕ_κ , 338
 Φ , 413
 f^Φ , 221
 μ_Φ , 221
 $\Phi(f)$, 257
 $\chi^2(k)$, 424
 ψ , 455, 456
 Ω , 377

Arrows

$\xrightarrow{\text{a.s.}}$, 403
 $\xrightarrow{\mathcal{P}}$, 403
 $\xrightarrow{\mathcal{L}}$, 403

Norms

$\|\cdot\|_{\text{HS}}$, 47
 $\|\cdot\|_{\mathcal{H}_p}$, 81
 $\|\cdot\|_{H^s}$, 100
 $\|\cdot\|_{K,p}$, 113
 $\|\cdot\|_{L_k^p}$, 63
 $\|\cdot\|_{L_k^2(T^N)}$, 103
 $|\cdot|_p$, 269
 $\|\cdot\|_{p,\alpha}$, 180
 $\|\cdot\|_{P,Q}$, 56
 $\|\cdot\|_{\alpha,\beta}$, 180

Other unary operations

∂U , 61
 \hat{a} , 153
 f^\vee , T^\vee , 189
 $f^\#$, $f^{\#\#}$, 234

Binary operations

$\langle T, \varphi \rangle$, 59, 181
 $K_1 - K_2$, xix, 129
 $f * h$, 237
 \oplus , 247
 $U \sqcup V$, $\bigsqcup_i W_i$, 335
 \sim , 357
 $\varphi_1 \otimes \varphi_2$, 361

Other symbols

1 , 214
 $\bar{\partial}$, 369
 $\frac{\partial}{\partial \bar{z}}$, 276
 $\left[\frac{\partial}{\partial x_j}\right]_p$, 328

INDEX

- about a point, 322
- absolutely uniform convergence, 6
- adele, 271
- adjoint, formal, 20
- Alaoglu's Theorem, **120**, 146
 - preliminary form, 81, 82
- algebra
 - associative, 121
 - Banach, 122, 146
 - commuting, 161
 - multiplication, 160
- almost periodic, **272**, 273
- amplitude, 356
- Approximation Theorem, **255**, 267, 274
- Artin product formula, 270
- Ascoli's Theorem, 145
- associated Legendre equation, 16
- associative algebra, 121
- Atiyah–Singer Index Theorem, 369
- atlas, 322
 - B*-spline, 478, **493**
 - Baire Category Theorem, 114, 264
 - Baire set, xxvi
 - Banach algebra, **122**, 146
 - band-limited, 440
 - base space, 338
 - basic separation theorem, 127
 - Battle–Lemarié degree, 483, **495**
 - Battle–Lemarié scaling function, 495
 - Battle–Lemarié wavelet, 483, **495**
 - Beltrami equation, 94
 - Bernstein polynomial, 430
 - Bessel function, 12, 31
 - Bessel potential, **100**, 543
 - Bessel's equation, 12
 - binomial distribution, 432
 - biorthogonal wavelet, 536
 - blocking, 442
 - Bohr compactification, 272
 - Borel set, xxvi
 - Borel–Cantelli Lemma, 398
 - boundary data, 2
 - boundary of open set, 61
 - boundary values, 2
 - boundary-value problem, 2, 277
 - bounding point, 126
 - Brouwer Fixed-point Theorem, 145
 - Brownian motion, **391**, 431
 - bundle
 - coordinate vector, 338
 - cotangent, 344
 - space, 338
 - tangent, 344
 - vector, 341
 - C^* algebra, 157
 - Calderón–Zygmund decomposition, 86
 - Calderón–Zygmund Theorem, **83**, 102, 370
 - Cantor diagonal process, 225
 - Cantor measure, 431
 - Cauchy data, 279, 280
 - Cauchy problem, **284**, 320
 - Cauchy–Kovalevskaya Theorem, **278**, 279, 281, 282, 318, 320
 - Cauchy–Peano Existence Theorem, 145
 - Cauchy–Riemann equations, 92, 276
 - Cauchy–Riemann operator, **287**, 318, 349
 - Central Limit Theorem, 413
 - chain rule, 331
 - character, 250
 - group, 250
 - multiplicative, 242
 - sign, 242
 - characteristic, 283
 - characteristic function, 409
 - chart, 322
 - atlas of, 322

- compatible, 322
- Chebyshev's inequality, 397
- chi-square distribution, 424
- circled set, 132
- closed convex hull, 140
- closed subgroup, 217
- Cohen–Daubechies–Feauveau family, 536
- coin tossing, 376
- commuting algebra, 161
- compact group, 217
- compact operator, 34
- compact ring, 270
- compactification
 - Bohr, 272
 - one-point, 124
 - Stone–Čech, 125
- compatible chart, 322
- completely continuous, 34
- complex tangent bundle, 344
- compression, 442, 535
- conditional probability, 383
- cone condition, 67
- constant coefficients, 279, 282, 292, 300
- continuity
 - complete, 34
 - left uniform, 273
 - strong, 256
 - uniform, 219
 - weak, 267
- continuous dual, 114
- contragredient representation, **245**, 266
- convergence
 - absolutely uniform, 6
 - almost surely, 403
 - in distribution, 404
 - in law, 404
 - in probability, 398, **403**
 - uniform on compact sets, 75
 - with probability 1, 403
- convex set, 125
- convolution
 - of distributions, 192, 195
 - of functions, 186, 237
 - of measures, 189
- coordinate function, 338
- coordinate transformation, 338
- coordinate vector bundle, 338
 - equivalence, 373
- cotangent bundle, 344
- countable, xxiii
- critical point, 372
- critical value, 372
- cumulative distribution function, 38
- curve, 333
 - integral, 333
- cyclic vector, 162
- Daubechies scaling function, **513**, 544
- Daubechies wavelet, 498, **513**, 544
 - order, 498, 513, **516**
- de Moivre and Laplace, 432
- de Rham's Theorem, 368
- decomposition algorithm, 533
- degree of B -spline, 483
- degree of Battle–Lemarié wavelet, 483, **495**
- degree of homogeneity, **xxiv**, 83, 355
- degree of representation, 250
- degree of spline, 476
- degrees of freedom, 420, 424
- density, 381
- derivation, 328
- derivative
 - transverse, 209
 - weak, **62**, 103, 290
- diffeomorphism, 326
- differential, 330
- differential 1-form, 348
 - smooth, 348
- differential operator, linear, 19, **353**
 - transpose of, 20, **353**
- differentiation of distribution, 188
- dimension of smooth manifold, 322
- Dirac distribution, 201
- Dirac operator, 369
- direct limit, **139**, 177
- direct sum, 247
- directed system, 177
- Dirichlet problem, **13**, 288
- discrete cosine transform, 537
- discrete group, 213
- discrete wavelet transform, 529
- disjoint union, 335
- distribution, **179**, 290, 352
 - arbitrary, 180
 - binomial, 432
 - chi-square, 424
 - convolution with, 192, 195
 - differentiation of, 188

- Dirac, 201
- equal to a locally integrable function, 183
- equal to a smooth function, 183
- Fourier series of, 209
- Fourier transform of, **60**, 202, 203
- gamma, 423
- given by function, 187
- Gosset's t , 420
- Heaviside, 318
- kernel, **310**, 357, 361
- localization of, 186
- normal, 413
- of compact support, **114**, 352
- of random variable, 379
- operation on, 187
- periodic, 209
- Poisson, 432
- probability, 379
- product with smooth function, 188
- Student's t , 420
- support of, 181
- supported at $\{0\}$, 208
- supported on vector subspace, 208
- tempered, 58
- distribution function, 380
- Divergence Theorem, 70

- eigenfunction, 19
- eigenspace, 36
- eigenvalue, 19, 36
- eigenvector, 36
- elliptic
 - differential equation, 288
 - operator, index, 368
 - pseudodifferential operator, **315**, 366
- equal to a function, distribution, 183
- equivalent coordinate vector bundles, 373
- equivalent representations, **244**, 259
 - unitarily, 266
- equivalent vector bundles, 373
- ergodic measure, **143**, 176
- essential image, 166
- event, 376, **378**
- exhausting sequence, **64**, 113, 350
- expectation, 379
- expected value, 379
- experiment, 418
- exponential type, 509
- extreme point, **140**, 175

- F. and M. Riesz Theorem, 102
- face, 140
- Fatou's Theorem, 81
- Fejér and F. Riesz Lemma, 504
- filter, 450, 498
- finite-dimensional representation, 241
- finite-dimensional topological vector space, 111
- formal adjoint, 20
- formally self adjoint, 20
- Fourier inversion formula for compact group, 267
- Fourier series
 - multiple, **96**, 98, 192
 - of distribution, 209
 - use in local solvability, 292
 - use in separation of variables, 5
- Fourier transform, 436
 - of distribution of compact support, 203
 - of tempered distribution, **60**, 202
- Franklin wavelet, 483
- Fréchet limit, 139
- Fréchet space, 139
- freezing principle, 285
- functional calculus, 167
- fundamental solution, 206, 290, 300, 302, 318

- gamma distribution, 423
- gamma function, 420
- Gårding's inequality, 286
- Gelfand transform, 153
- Gelfand–Mazur Theorem, 151
- general linear group, 213, 371
- generalized pseudodifferential operator, 356
 - transpose of, 356
- generating function, 455, 456
- germ, 327
- Gibbs phenomenon, 438
- Gosset, 418
- Gosset's t distribution, 420
- Green's formula, 20, 31, 72, 73, 206
- Green's function, **25**, 290
- group action, 222
- group character, 250

- Haar covering function, 226
- Haar measure, **223**, 232
- Haar multiresolution analysis, 454

- Haar scaling function, 444
- Haar series expansion
 - one-sided, 450
 - two-sided, 449
- Haar system, **443**, 444, 541
- Haar wavelet, 444
- Hahn–Banach Theorem, 126
- half space
 - Poisson integral formula, 80
 - Poisson kernel, 80
- Hardy space, 101
- harmonic, 2, **69**
- harmonic measure, 317
- harmonic polynomial, **244**, 263
- heat equation, 2, **6**
- heat operator, 287
- Heaviside distribution, 318
- Heaviside function, 318
- Helmert matrix, 428
- Hermite polynomial, 32
- Hermite’s equation, 32
- Hermitian matrix, 36
- high-pass filter, 450
- Hilbert transform, **xxvi**, 83, 92, 101, 211
- Hilbert–Schmidt norm, 47
- Hilbert–Schmidt operator, 47
- Hilbert–Schmidt Theorem, 22, 25, **42**, 43
- Hirzebruch–Riemann–Roch Theorem, 369
- Hodge theory, 368
- Hölder condition, 523
- holomorphic polynomial, 243
- homogeneous function, **xxiv**, 83, 355
- homogeneous partial differential equation,
 - 1, 276
- homogeneous space, 214
- homomorphism of topological groups, 213
- Hopf maximum principle, 297
- hyperbolic, 289

- idele, 272
- identically distributed, 381
- identification space, 335
- identity component, 264
- identity element, 214
- independent events, 384
- independent random variables, 385
- index
 - Meyer, 472
 - of elliptic operator, 368
- indicator function, xxv
- inductive limit topology, **139**, 174
- initial data, 2
- initial-value problem, 277
- integrable locally, 62
- integral curve, 333
- integral operator, 41
 - trace of, 98
- Interior Mapping Theorem, 173
- internal point, 126
- invariant subspace, 243, **259**
- inverse, 149
- invertible, 149
- involution, 157
- irreducible representation, 245, **259**
- isomorphism of topological groups, 213
- isomorphism of topological vector spaces, 106
- isotypic subspace, 261

- joint probability density, 382
- joint probability distribution, 381
- JPEG, 442, **536**
- JPEG 2000, 539

- kernel
 - distribution, **310**, 357, 361
 - of integral operator, 41
 - Poisson, 15, 80
- knot of spline, 477
- Kolmogorov Extension Theorem, **394**, 430
- Kolmogorov’s inequality, 399
- Krein–Milman Theorem, 140

- Laplace equation, 2, 13
- Laplacian, **2**, 206, 276, 287
- Law of Large Numbers
 - Strong, 398
 - Weak, 398
- left almost periodic, 272
- left coset, 214
- left Haar measure, 223
- left inverse, 149
- left parametrix, 310
- left uniform continuity, 273
- left-invariant vector field, 371
- left-regular representation, 256
- Legendre equation
 - associated, 16
 - ordinary, 16

- Legendre polynomial, **16**, 31
- Leibniz rule, 63
- Lévy Continuity Theorem, 411
- Lévy example, **286**, 349
- LF topology, 139
- Lie group, 349
- line segment, 140
- linear
 - differential operator, 19, **353**
 - functional, multiplicative, **122**, 148, 152
 - homogeneous partial differential equation, 276
 - operator (*see* operator)
 - partial differential equation, 1, 276
 - partial differential operator, **185**, 188
 - topological space, 106
- Liouville, 78
- local coordinate system, **323**, 372
- local neighborhood base, 132
- local solvability, 292
- localization of distribution, 186
- locally compact abelian group, 270
- locally compact field, 270
- locally compact group, 217
- locally compact ring, 271
- locally compact topological vector space, **111**, 265
- locally convex, 128
- locally integrable, 62
- low-pass filter, **450**, 498

- magnification, 449
- manifold, 322
 - Riemannian, 349
 - smooth, 322
- mapping function, 373
- Marcinkiewicz Interpolation Theorem, 95
- margin of error, 417
- Markov–Kakutani Theorem, 143
- matrix
 - Hermitian, 36
 - orthogonal, **218**, 426
 - rotation, 218
 - trace of, 249
 - unitary, 37, **218**
- matrix coefficient, 250
- matrix representation, 241
- maximal abelian self-adjoint subalgebra, 161
- maximal ideal, 152

- maximum principle, 297
- mean, 379
 - sample, 420
- mean-value property, **72**, 73
- measurable set of type F , 393
- measure
 - Cantor, 431
 - harmonic, 317
 - smooth, 351
- measure 0, 372
- metric, Riemannian, 349
- Meyer index, 472
- Meyer multiresolution analysis, 472
- Meyer scaling function, 473
- Meyer system, **473**, 542
- Meyer wavelet, **474**, 542
- modular function, 230
- modulus of ellipticity, 296
- Monotone Class Lemma, 170
- multi-index, 55
- multiple Fourier series, **96**, 98, 102
 - of distribution, 209
 - use in local solvability, 292
- multiplication algebra, 160
- multiplication of smooth function
 - and distribution, 188
- multiplicative character, 242
- multiplicative linear functional, **122**, 148, 152
- multiplicity, 251
- multiresolution analysis, 454
 - Daubechies system, 512
 - Haar system, 454
 - Meyer, 472
 - Shannon, 466
- negative, xxiii
- noncharacteristic, 283
- norm, Hilbert–Schmidt, 47
- normal distribution, 413
- normal operator, 52, **165**
- normed linear space, 107

- one-dimensional wavelet, 435
- one-point compactification, 124
- one-sided wavelet expansion, 529
- operation on distribution, 187
 - by -1 in domain, 189
 - by convolution, 192, 195
 - by linear partial differential operator, 188

- of differentiation, 188
 - of Fourier transform, 202
 - of multiplication, 188
 - of transpose, 187
- operator
 - compact, 34
 - completely continuous, 34
 - differential, linear, 353
 - Dirac, 369
 - elliptic, 288
 - elliptic pseudodifferential, **315**, 366
 - generalized pseudodifferential, 356
 - Hilbert–Schmidt, 47
 - hyperbolic, 289
 - integral, 41
 - normal, 52, **165**
 - orthogonal, 45
 - positive semidefinite, 165
 - pseudodifferential, 306, **308**, 362
 - smoothing, 291, 301, 308, 357
 - trace of, **51**, 98
 - trace-class, 49
 - transpose of, 185
 - unitary, **45**, 163, 165
- order of Daubechies wavelet, 498, 513, **516**
- order of differential equation, 276
- order of differential operator, **185**, 353
- orthogonal group, 218
- orthogonal matrix, **218**, 426
- orthogonal operator, 45
- orthogonal wavelet, 435
- orthonormalization trick, 483
- p -adic integer, 270
- p -adic norm, 269
- Paley–Wiener Theorem, 512, 517, **518**
- parametrix, 292, **301**, 307, 310, 315
- partial differential equation, 276
 - elliptic, 288
 - homogeneous, 1, 276
 - hyperbolic, 289
 - linear, 1, 276
 - linear homogeneous, 276
 - order, 276
 - system, 276
- partial differential operator
 - elliptic, 288
 - hyperbolic, 289
 - linear **185**, 188
 - transpose of, **185**, 353
- partition of unity, **65**, 113, 174, 351, 371
- periodic distribution, 209
- Peter–Weyl Theorem, 252
- Phragmén–Lindelöf Theorem, 517
- Picard–Lindelöf Existence Theorem, 145
- Plancherel formula for compact group, **254**, 257
- Poisson distribution, 432
- Poisson integral formula for half space, 80
- Poisson integral formula for unit disk, 15
- Poisson kernel for half space, 80
- Poisson kernel for unit disk, 15
- Poisson’s equation, 291
- polynomial
 - Bernstein, 430
 - harmonic, **244**, 263
 - holomorphic, 243
 - trigonometric, 254, 499
- Portmanteau Lemma, 406
- positive, xxiii
- positive definite function, **142**, 176
- positive semidefinite operator, 165
- Principal Axis Theorem, 289
- principal symbol, **287**, 355, 364
- probability, 376, **378**
 - conditional, 383
 - joint, 382
- probability distribution, 379
 - joint, 381
- probability model, 376
- probability space, 378
- product of topological groups, 213
- projection, 338
- projective space, 371
- properly supported, 313, 357, 361
- pseudodifferential operator, 306, **308**, 362
 - elliptic, **315**, 366
 - generalized, 356
 - transpose of, 308, **356**
- pseudolocal, **311**, 357, 362
- pseudonorm, 56
- pull back, 221
- push forward, 221
- quotient of topological vector space, 110
- quotient space, 214
 - of Lie group, 349
- Radon–Nikodym Theorem, 224

- random number, 378
- random variable, 378
- rank, 338
- real analytic, 528
- real tangent bundle, 344
- reconstruction algorithm, 534
- regularizing, 61
- Rellich's Lemma, 368
- representation
 - contragredient, **245**, 266
 - finite-dimensional, 241
 - irreducible, 245, **259**
 - left-regular, 256
 - matrix, 241
 - right-regular, 257
 - standard, 242
 - trivial, 242
 - unitary, 245, 256
- resolution, 449
- resolvent, 150
- resolvent set, 150
- restricted direct product, **178**, 271
- Riemann–Roch Theorem, 369
- Riemannian manifold, 349
- Riemannian metric, 349
- Riesz Convexity Theorem, 95
- Riesz Representation Theorem, 118, 164, 220
- Riesz transform, 93
- right almost periodic, 272
- right group action, 223
- right Haar measure, 223
- right inverse, 149
- right parametrix, 307
- right-regular representation, 257
- rotation group, 218
- rotation matrix, 218

- sample, 418
- sample mean, 420
- sample variance, 420
- sampling, 439
- Sard's Theorem, 372
- satisfy cone condition, 67
- scaling equation, 455
- scaling filter, 498
- scaling function, 454
 - Battle-Lemarié, 495
 - Daubechies, **513**, 544
 - Haar, 444
 - Meyer, 473
 - Shannon, **465**, 510
- Schauder–Tychonoff Theorem, 144
- Schrödinger's equation, 32
- Schur orthogonality, 249
- Schur's Lemma, 247
- Schwartz Kernel Theorem, 209, **361**
- Schwartz space, 55
- Schwarz Reflection Principle, 78
- section, 347
 - smooth, 347
- self adjoint, formally, 20
- self-adjoint subalgebra, 161
- seminorm, 56
- separable, xxv
- separating family of seminorms, 57, **107**
- separation of variables, 1, **3**
- Shannon multiresolution analysis, 466
- Shannon Sampling Theorem, **440**, 535
- Shannon scaling function, **465**, 510
- Shannon system, 465
- Shannon wavelet, **466**, 468
- sign character, 242
- signal, 435
- singular support, **183**, 303, 362
- smooth curve, 333
- smooth differential 1-form, 348
- smooth function, 323, **326**
- smooth manifold, 322
 - dimension, 322
- smooth measure, 351
- smooth section, 347
- smooth structure, 322
- smooth vector field, 331, 332, 348
- smoothing operator, 291, 301, 308, 357
- Sobolev space, **63**, 100, 103, 290, 308, 366
- Sobolev's Theorem, 67, 69, 100, 103, 368
- space-boundary data, 2
- special linear group, 218
- Spectral Mapping Theorem, 155
- spectral radius, 150
- spectral radius formula, 155
- Spectral Theorem
 - finite-dimensional, 37
 - for bounded normal operator, 166
 - for bounded self-adjoint operator, 165
 - for compact self-adjoint operator, 39
 - for unbounded self-adjoint operator, 172
- spectrum, 150, 167

- spline, 476
 - of compact support, 477
- standard representation, 242
- standard symbol, 307
- statistical inference, 417
- Stieltjes integral, 380
- stochastic process, 393
- Stone Representation Theorem, **121**, 147, 176
- Stone–Čech compactification, 125
- Stone–Weierstrass Theorem, 31, 124, 169, 263
- strict equivalence, 341
- strict inductive limit topology, 139
- strong continuity, 256
- Strong Law of Large Numbers, 398
- Student’s t distribution, 420
- Sturm–Liouville eigenvalue problem, 20
- Sturm–Liouville theory, 5, **19**, 172
- Sturm’s Theorem, 5, 21
- superposition principle, 1
- support function of convex set, 126
- support of distribution, 115, **181**, 352
 - singular, 183, 303, 362
- support of function, **xxv**, 324
- supported properly, 313, 357, 361
- symbol, **287**, 306
 - principal, **287**, 355, 364
 - standard, 307
- symplectic group, 218
- system of partial differential equations, 276

- t distribution, 420
- tangent bundle, **332**, 344
- tangent space, 328
- tangent vector, 328
- tempered distribution, 58
- Theorem of de Moivre and Laplace, 432
- topological field, 269
- topological group, 213
 - isomorphism for, 213
- topological ring, 270
- topological vector space, 106
 - defined by seminorms, 107
 - finite-dimensional, 111
 - isomorphism for, 106
 - locally compact, **111**, 265
 - locally convex, 128
 - quotient of, 110
- trace of integral operator, 98
- trace of linear map, 249
- trace of matrix, 249
- trace of operator, 51
- trace-class operator, 49
- transition function, 338
- transition matrix, 338
- translate, 190
- transpose, 187, 352
 - of generalized pseudodifferential operator, 356
 - of operator, 185
 - of ordinary differential operator, 20
 - of partial differential operator, **185**, 353
 - of pseudodifferential operator, 308, **356**
- transverse derivative, 209
- trigonometric polynomial, 254, 499
- trivial representation, 242
- two-sided parametrix, 315
- Tychonoff Product Theorem, 120, 225

- ultrametric inequality, 269
- Uncertainty Principle, 436
- uniform continuity, 219
 - left, 273
- uniform convergence on compact sets, 75
- unimodular group, 232
- unit disk
 - Poisson integral formula, 15
 - Poisson kernel, 15
- unit sphere, 370
- unitarily equivalent, 266
- unitary group, 218
- unitary matrix, 37, **218**
- unitary operator, **45**, 163, 165
- unitary representation, 245, 256
- Urysohn Metrization Theorem, 323

- Vandermonde convolution, 542
- variance, 397
 - sample, 420
- vector bundle, 341
 - coordinate, 338
 - equivalence, 373
- vector field, 331, 348
 - left-invariant, 371
 - smooth, 331, 332, 348
- vibrating drum, 18
- vibrating string, 17

- wave operator, 287

- wave equation, 3, **17**
- wavelet, **435**, 455
 - Battle–Lemarié, 483, **495**
 - biorthogonal, 536
 - Cohen–Daubechies–Feauveau, 536
 - Daubechies, 498, **513**, 544
 - Franklin, 483
 - Haar, 444
 - Meyer, **474**, 542
 - one-dimensional, 435
 - orthogonal, 435
 - Shannon, **466**, 468
- wavelet equation, 456
 - one-sided, 529
- wavelet expansion, 435
- weak continuity, 267
- weak derivative, **62**, 103, 290
- Weak Law of Large Numbers, 398
- weak topology on normed linear space, 108,
116
- weak-star topology on dual of normed linear
space, 109, **116**
- weakly analytic, 150
- Weierstrass Approximation Theorem, 430
- Weyl integration formula, 269
- Wiener Covering Lemma, 87

