

Anti-Self-Dual 4-Manifolds,

Quasi-Fuchsian Groups, &

Almost-Kähler Geometry

Claude LeBrun

Stony Brook University

Oberseminar Geometrie und Topologie
Universität Stuttgart, October 9, 2018

Discussion will mention results from

Discussion will mention results from

Weyl Curvature, Del Pezzo Surfaces,
and Almost-Kähler Geometry,

Discussion will mention results from

Weyl Curvature, Del Pezzo Surfaces,
and Almost-Kähler Geometry,

Journal of Geometric Analysis
25 (2015) 1744–1772

Most recent results joint with

Most recent results joint with

Christopher J. Bishop
Stony Brook University

Most recent results joint with

Christopher J. Bishop
Stony Brook University

e-print: [arXiv:1708.03824](https://arxiv.org/abs/1708.03824) [math.DG]

Most recent results joint with

Christopher J. Bishop
Stony Brook University

e-print: [arXiv:1708.03824](https://arxiv.org/abs/1708.03824) [math.DG]

To appear in **Comm. An. Geom.**

Facets of Kähler Geometry:

Facets of Kähler Geometry:

Complex Geometry

Facets of Kähler Geometry:

Complex Geometry

Symplectic Geometry

Facets of Kähler Geometry:

Complex Geometry

Symplectic Geometry

Metric Geometry

Facets of Kähler Geometry:

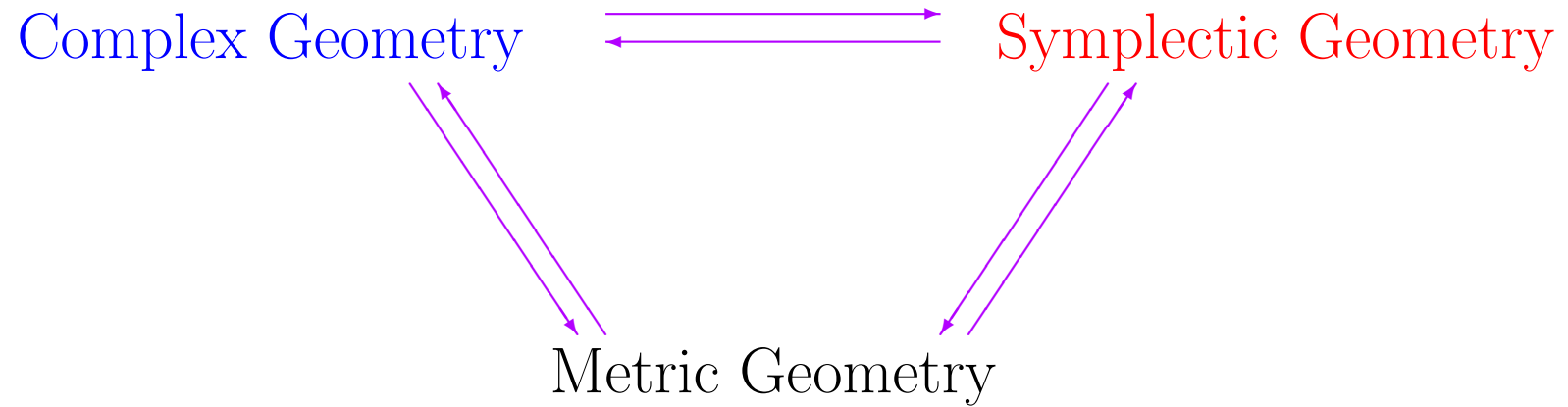

Facets of Kähler Geometry:

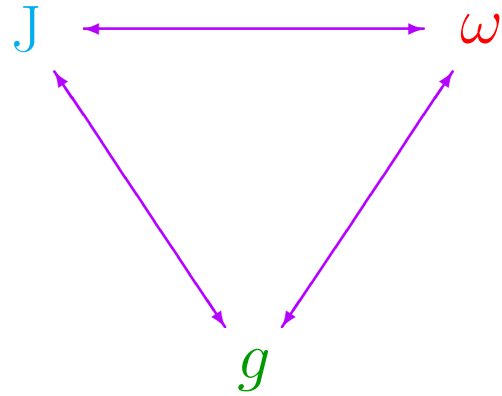

Almost-Kähler Geometry:

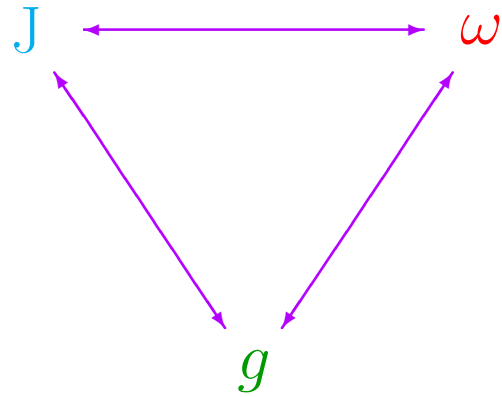

Almost-Kähler Geometry:

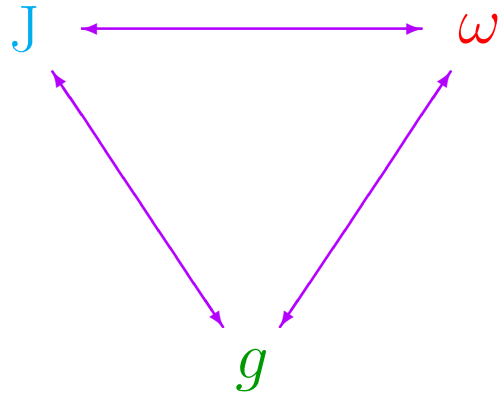

Drop demand that J be integrable.

Almost-Kähler Geometry:

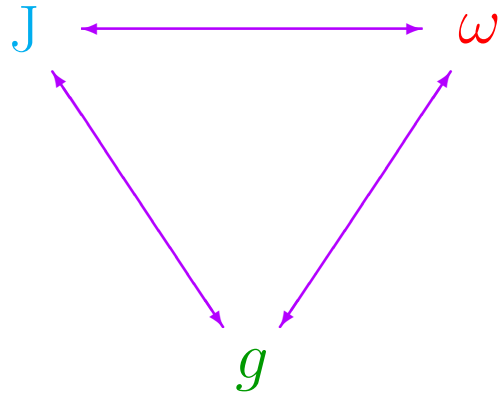

Drop demand that J be integrable.

Linked to conformal geometry in dimension 4.

Almost-Kähler Geometry:

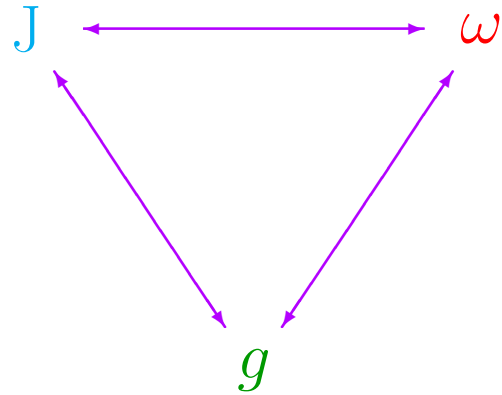

Drop demand that J be integrable.

Linked to conformal geometry in dimension 4.

Higher dimensions are demonstrably different.

Let (M^{2m}, ω) be a symplectic manifold.

Let (M^{2m}, ω) be a compact symplectic manifold.

Let (M^{2m}, ω) be a compact symplectic manifold.

Thus, ω is a 2-form with $d\omega = 0$

Let (M^{2m}, ω) be a compact symplectic manifold.

Thus, ω is a 2-form with $d\omega = 0$ and $\omega^m \neq 0$.

Let (M^{2m}, ω) be a compact symplectic manifold.

Thus, ω is a 2-form with $d\omega = 0$ and $\omega^{\wedge m} \neq 0$.

By convention, orient M so that $\omega^{\wedge m} > 0$.

Let (M^{2m}, ω) be a compact symplectic manifold.

Thus, ω is a 2-form with $d\omega = 0$ and $\omega^{\wedge m} \neq 0$.

By convention, orient M so that $\omega^{\wedge m} > 0$.

$\Rightarrow \exists$ compatible almost-complex structures J :

Let (M^{2m}, ω) be a compact symplectic manifold.

Thus, ω is a 2-form with $d\omega = 0$ and $\omega^{\wedge m} \neq 0$.

By convention, orient M so that $\omega^{\wedge m} > 0$.

$\Rightarrow \exists$ compatible almost-complex structures J :

$$J : TM \rightarrow TM, \quad J^2 = -1,$$

Let (M^{2m}, ω) be a compact symplectic manifold.

Thus, ω is a 2-form with $d\omega = 0$ and $\omega^{\wedge m} \neq 0$.

By convention, orient M so that $\omega^{\wedge m} > 0$.

$\Rightarrow \exists$ compatible almost-complex structures J :

$$J : TM \rightarrow TM, \quad J^2 = -1,$$

$$J^*\omega = \omega,$$

Let (M^{2m}, ω) be a compact symplectic manifold.

Thus, ω is a 2-form with $d\omega = 0$ and $\omega^{\wedge m} \neq 0$.

By convention, orient M so that $\omega^{\wedge m} > 0$.

$\Rightarrow \exists$ compatible almost-complex structures J :

$$J : TM \rightarrow TM, \quad J^2 = -1,$$

$$J^*\omega = \omega, \quad \omega(v, Jv) > 0 \quad \forall v \neq 0.$$

Let (M^{2m}, ω) be a compact symplectic manifold.

Thus, ω is a 2-form with $d\omega = 0$ and $\omega^{\wedge m} \neq 0$.

By convention, orient M so that $\omega^{\wedge m} > 0$.

$\Rightarrow \exists$ compatible almost-complex structures J :

$$J : TM \rightarrow TM, \quad J^2 = -1,$$

$$J^*\omega = \omega, \quad \omega(v, Jv) > 0 \quad \forall v \neq 0.$$

Leads to theory of J -holomorphic curves,

Let (M^{2m}, ω) be a compact symplectic manifold.

Thus, ω is a 2-form with $d\omega = 0$ and $\omega^{\wedge m} \neq 0$.

By convention, orient M so that $\omega^{\wedge m} > 0$.

$\Rightarrow \exists$ compatible almost-complex structures J :

$$J : TM \rightarrow TM, \quad J^2 = -1,$$

$$J^*\omega = \omega, \quad \omega(v, Jv) > 0 \quad \forall v \neq 0.$$

Leads to theory of J -holomorphic curves,
Gromov-Witten invariants, etc.

Let (M^{2m}, ω) be a compact symplectic manifold.

Thus, ω is a 2-form with $d\omega = 0$ and $\omega^{\wedge m} \neq 0$.

By convention, orient M so that $\omega^{\wedge m} > 0$.

$\Rightarrow \exists$ compatible almost-complex structures J :

$$J : TM \rightarrow TM, \quad J^2 = -1,$$

$$J^*\omega = \omega, \quad \omega(v, Jv) > 0 \quad \forall v \neq 0.$$

Leads to theory of J -holomorphic curves,
Gromov-Witten invariants, etc.

Imitates Kähler geometry in a non-Kähler setting.

Let (M^{2m}, ω) be a compact symplectic manifold.

Thus, ω is a 2-form with $d\omega = 0$ and $\omega^{\wedge m} \neq 0$.

By convention, orient M so that $\omega^{\wedge m} > 0$.

$\Rightarrow \exists$ compatible almost-complex structures J :

$$J : TM \rightarrow TM, \quad J^2 = -1,$$

$$J^*\omega = \omega, \quad \omega(v, Jv) > 0 \quad \forall v \neq 0.$$

Let (M^{2m}, ω) be a compact symplectic manifold.

Thus, ω is a 2-form with $d\omega = 0$ and $\omega^{\wedge m} \neq 0$.

By convention, orient M so that $\omega^{\wedge m} > 0$.

$\Rightarrow \exists$ compatible almost-complex structures J :

$$J : TM \rightarrow TM, \quad J^2 = -1,$$

$$J^*\omega = \omega, \quad \omega(v, Jv) > 0 \quad \forall v \neq 0.$$

$\Rightarrow g := \omega(\cdot, J\cdot)$ is a Riemannian metric.

Let (M^{2m}, ω) be a compact symplectic manifold.

Thus, ω is a 2-form with $d\omega = 0$ and $\omega^{\wedge m} \neq 0$.

By convention, orient M so that $\omega^{\wedge m} > 0$.

$\Rightarrow \exists$ compatible almost-complex structures J :

$$J : TM \rightarrow TM, \quad J^2 = -1,$$

$$J^*\omega = \omega, \quad \omega(v, Jv) > 0 \quad \forall v \neq 0.$$

$\Rightarrow g := \omega(\cdot, J\cdot)$ is a Riemannian metric.

Such g are called almost-Kähler metrics, because

Let (M^{2m}, ω) be a compact symplectic manifold.

Thus, ω is a 2-form with $d\omega = 0$ and $\omega^{\wedge m} \neq 0$.

By convention, orient M so that $\omega^{\wedge m} > 0$.

$\Rightarrow \exists$ compatible almost-complex structures J :

$$J : TM \rightarrow TM, \quad J^2 = -1,$$

$$J^*\omega = \omega, \quad \omega(v, Jv) > 0 \quad \forall v \neq 0.$$

$\Rightarrow g := \omega(\cdot, J\cdot)$ is a Riemannian metric.

Such g are called almost-Kähler metrics, because

Kähler $\iff J$ integrable.

Discussion involves three intertwined structures:

Discussion involves three intertwined structures:

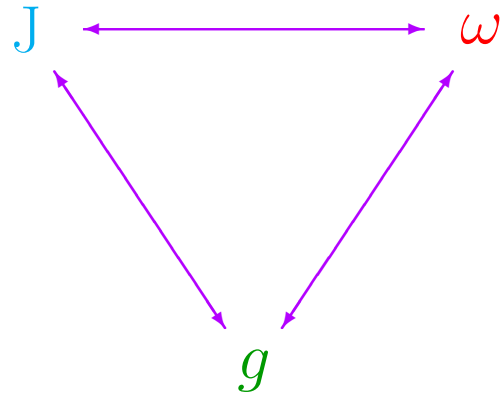

Discussion involves three intertwined structures:

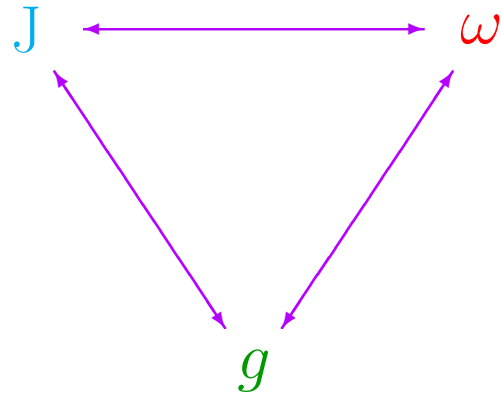

Any two algebraically determine the third.

Discussion involves three intertwined structures:

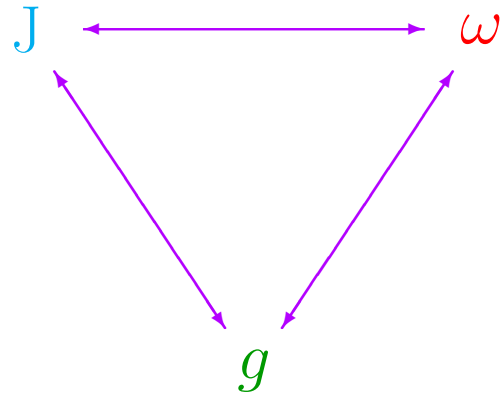

Any two algebraically determine the third.

For example, can avoid explicitly mentioning J .

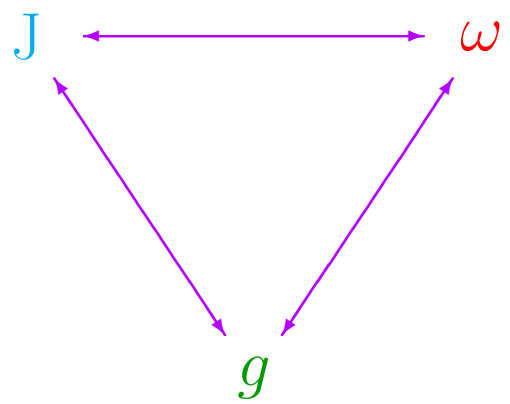

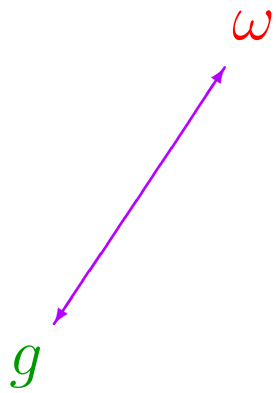

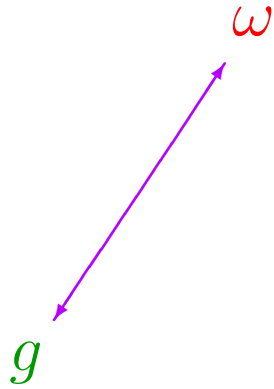

Lemma. *An oriented Riemannian manifold (M^{2m}, g)*

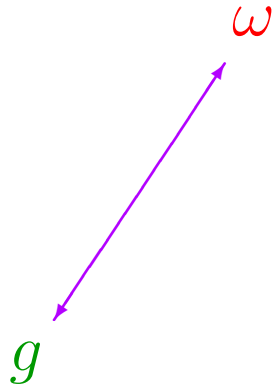

Lemma. *An oriented Riemannian manifold (M^{2m}, g) is almost-Kähler*

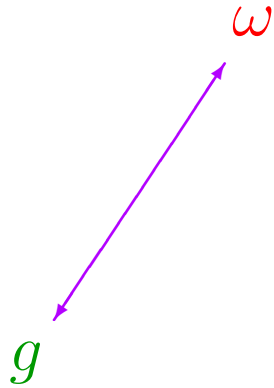

Lemma. *An oriented Riemannian manifold (M^{2m}, g) is almost-Kähler w/ respect to the 2-form ω*

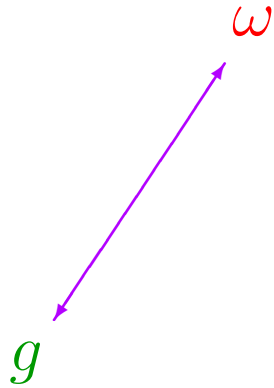

Lemma. *An oriented Riemannian manifold (M^{2m}, g) is almost-Kähler w/ respect to the 2-form $\omega \iff$*

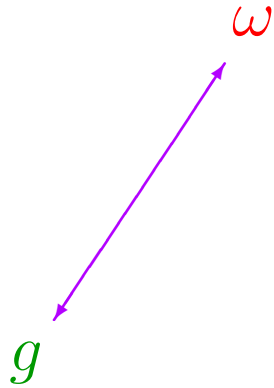

Lemma. *An oriented Riemannian manifold (M^{2m}, g) is almost-Kähler w/ respect to the 2-form $\omega \iff$*

- $|\omega|_g \equiv \sqrt{m},$

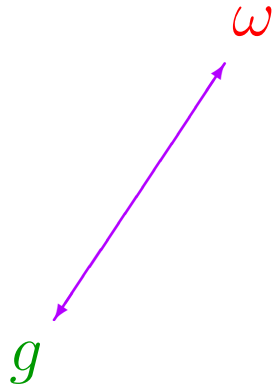

Lemma. *An oriented Riemannian manifold (M^{2m}, g) is almost-Kähler w/ respect to the 2-form $\omega \iff$*

- $|\omega|_g \equiv \sqrt{m}$,
- $d\omega = 0$, and

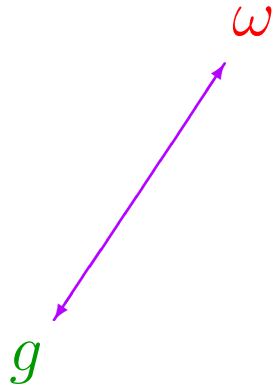

Lemma. *An oriented Riemannian manifold (M^{2m}, g) is almost-Kähler w/ respect to the 2-form $\omega \iff$*

- $|\omega|_g \equiv \sqrt{m},$
- $d\omega = 0,$ and
- $*\omega = \frac{\omega^{\wedge(m-1)}}{(m-1)!}.$

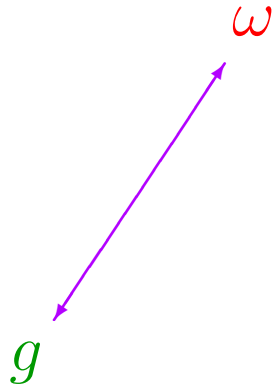

Lemma. *An oriented Riemannian manifold (M^{2m}, g) is almost-Kähler w/ respect to the 2-form $\omega \iff$*

- $|\omega|_g \equiv \sqrt{m},$
- ω is a harmonic 2-form, and
- $*\omega = \frac{\omega^{\wedge(m-1)}}{(m-1)!}.$

Simplifies dramatically when $m = 2$:

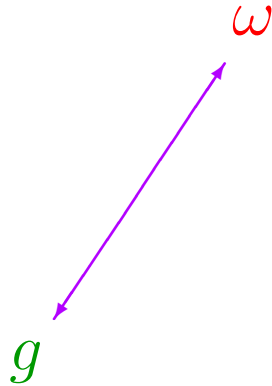

Lemma. *An oriented Riemannian manifold (M^{2m}, g) is almost-Kähler w/ respect to the 2-form $\omega \iff$*

- $|\omega|_g \equiv \sqrt{m}$,
- ω is a harmonic 2-form, and
- $*\omega = \frac{\omega^{\wedge(m-1)}}{(m-1)!}$.

Simplifies dramatically when $m = 2$:

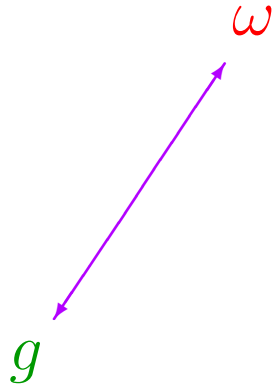

Lemma. An oriented Riemannian 4-manifold (M, g) is *almost-Kähler* w/ respect to the 2-form $\omega \iff$

- $|\omega|_g \equiv \sqrt{2}$,
- ω is a harmonic 2-form, and
- $*\omega = \omega$.

On oriented (M^4, g) ,

$$\Lambda^2 = \Lambda^+ \oplus \Lambda^-$$

On oriented (M^4, g) ,

$$\Lambda^2 = \Lambda^+ \oplus \Lambda^-$$

Λ^+ self-dual 2-forms:

$(+1)$ -eigenspace of $*$: $\Lambda^2 \rightarrow \Lambda^2$.

On oriented (M^4, g) ,

$$\Lambda^2 = \Lambda^+ \oplus \Lambda^-$$

Λ^+ self-dual 2-forms:

$(+1)$ -eigenspace of $*$: $\Lambda^2 \rightarrow \Lambda^2$.

Λ^- anti-self-dual 2-forms:

(-1) -eigenspace of $*$: $\Lambda^2 \rightarrow \Lambda^2$.

Simplifies dramatically when $m = 2$:

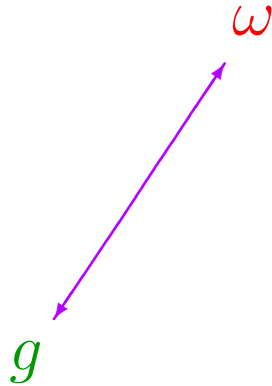

Lemma. An oriented Riemannian 4-manifold (M, g) is *almost-Kähler* w/ respect to the 2-form $\omega \iff$

- $|\omega|_g \equiv \sqrt{2}$,
- ω is a harmonic 2-form, and
- $*\omega = \omega$.

Simplifies dramatically when $m = 2$:

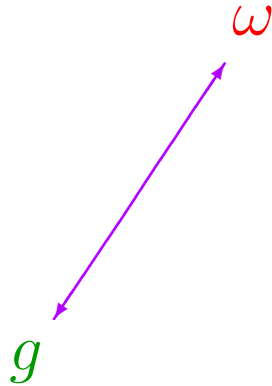

Lemma. *An oriented Riemannian 4-manifold (M, g) is almost-Kähler w/ respect to the 2-form $\omega \iff$*

- $|\omega|_g \equiv \sqrt{2}$,
- ω is a self-dual harmonic 2-form.

On oriented (M^4, g) ,

$$\Lambda^2 = \Lambda^+ \oplus \Lambda^-$$

Λ^+ self-dual 2-forms:

$(+1)$ -eigenspace of $*$: $\Lambda^2 \rightarrow \Lambda^2$.

Λ^- anti-self-dual 2-forms:

(-1) -eigenspace of $*$: $\Lambda^2 \rightarrow \Lambda^2$.

On oriented (M^4, g) ,

$$\Lambda^2 = \Lambda^+ \oplus \Lambda^-$$

Λ^+ self-dual 2-forms:

$(+1)$ -eigenspace of $*$: $\Lambda^2 \rightarrow \Lambda^2$.

Λ^- anti-self-dual 2-forms:

(-1) -eigenspace of $*$: $\Lambda^2 \rightarrow \Lambda^2$.

But Hodge star

$$* : \Lambda^2 \rightarrow \Lambda^2$$

is conformally invariant on middle-dimensional forms:

On oriented (M^4, g) ,

$$\Lambda^2 = \Lambda^+ \oplus \Lambda^-$$

Λ^+ self-dual 2-forms:

$(+1)$ -eigenspace of $*$: $\Lambda^2 \rightarrow \Lambda^2$.

Λ^- anti-self-dual 2-forms:

(-1) -eigenspace of $*$: $\Lambda^2 \rightarrow \Lambda^2$.

But Hodge star

$$* : \Lambda^2 \rightarrow \Lambda^2$$

is conformally invariant on middle-dimensional forms:

Only depends on the conformal class

$$[g] := \{u^2 g \mid u : M \rightarrow \mathbb{R}^+\}.$$

On oriented $(M^4, [g])$,

$$\Lambda^2 = \Lambda^+ \oplus \Lambda^-$$

Λ^+ self-dual 2-forms:

$(+1)$ -eigenspace of $*$: $\Lambda^2 \rightarrow \Lambda^2$.

Λ^- anti-self-dual 2-forms:

(-1) -eigenspace of $*$: $\Lambda^2 \rightarrow \Lambda^2$.

Only depends on the conformal class

$$[g] := \{u^2 g \mid u : M \rightarrow \mathbb{R}^+\}.$$

Simplifies dramatically when $m = 2$:

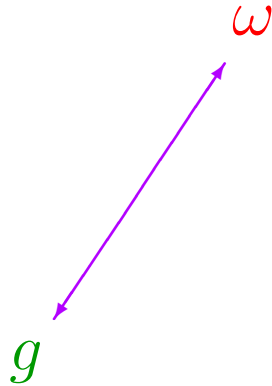

Lemma. An oriented Riemannian 4-manifold (M, g) is *almost-Kähler* w/ respect to the 2-form $\omega \iff$

- $|\omega|_g \equiv \sqrt{2}$,
- ω is a *self-dual* harmonic 2-form.

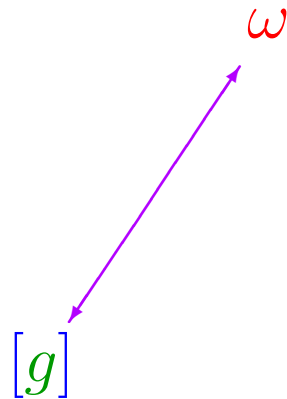

Proposition. *A conformal class $[g]$ on a smooth compact oriented 4-manifold M is represented by an almost-Kähler metric g iff it carries a self-dual harmonic 2-form ω that is $\neq 0$ everywhere.*

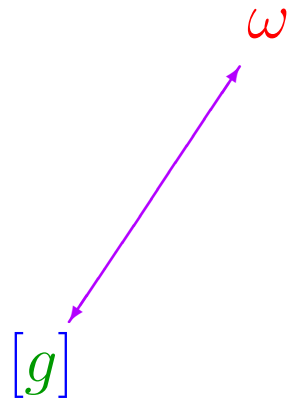

Proposition. *A conformal class $[g]$ on a smooth compact oriented 4-manifold M is represented by an almost-Kähler metric g iff it carries a self-dual harmonic 2-form ω that is $\neq 0$ everywhere.*

Moreover, the set of conformal classes $[g]$ on M that carry such a harmonic form ω is open in the C^2 topology.

Hodge theory:

$$H^2(M, \mathbb{R}) = \{\varphi \in \Gamma(\Lambda^2) \mid d\varphi = 0, d*\varphi = 0\}.$$

Hodge theory:

$$H^2(M, \mathbb{R}) = \{\varphi \in \Gamma(\Lambda^2) \mid d\varphi = 0, d*\varphi = 0\}.$$

Since $*$ is involution of RHS, \implies

$$H^2(M, \mathbb{R}) = \mathcal{H}_g^+ \oplus \mathcal{H}_g^-,$$

Hodge theory:

$$H^2(M, \mathbb{R}) = \{\varphi \in \Gamma(\Lambda^2) \mid d\varphi = 0, d*\varphi = 0\}.$$

Since $*$ is involution of RHS, \implies

$$H^2(M, \mathbb{R}) = \mathcal{H}_g^+ \oplus \mathcal{H}_g^-,$$

where

$$\mathcal{H}_g^\pm = \{\varphi \in \Gamma(\Lambda^\pm) \mid d\varphi = 0\}$$

self-dual & anti-self-dual harmonic forms.

Hodge theory:

$$H^2(M, \mathbb{R}) = \{\varphi \in \Gamma(\Lambda^2) \mid d\varphi = 0, d * \varphi = 0\}.$$

Since $*$ is involution of RHS, \implies

$$H^2(M, \mathbb{R}) = \mathcal{H}_g^+ \oplus \mathcal{H}_g^-,$$

where

$$\mathcal{H}_g^\pm = \{\varphi \in \Gamma(\Lambda^\pm) \mid d\varphi = 0\}$$

self-dual & anti-self-dual harmonic forms.

One can choose a basis for \mathcal{H}_g^\pm that depends continuously on g in the $C^{1,\alpha}$ topology.

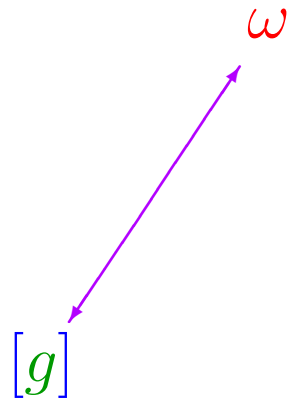

Proposition. *A conformal class $[g]$ on a smooth compact oriented 4-manifold M is represented by an almost-Kähler metric g iff it carries a self-dual harmonic 2-form ω that is $\neq 0$ everywhere.*

Moreover, the set of conformal classes $[g]$ on M that carry such a harmonic form ω is open in the C^2 topology.

“Conformal classes of symplectic type”

Proposition. *A conformal class $[g]$ on a smooth compact oriented 4-manifold M is represented by an almost-Kähler metric g iff it carries a self-dual harmonic 2-form ω that is $\neq 0$ everywhere.*

Moreover, the set of conformal classes $[g]$ on M that carry such a harmonic form ω is open in the C^2 topology.

Hodge theory:

$$H^2(M, \mathbb{R}) = \{\varphi \in \Gamma(\Lambda^2) \mid d\varphi = 0, d * \varphi = 0\}.$$

Since $*$ is involution of RHS, \implies

$$H^2(M, \mathbb{R}) = \mathcal{H}_g^+ \oplus \mathcal{H}_g^-,$$

where

$$\mathcal{H}_g^\pm = \{\varphi \in \Gamma(\Lambda^\pm) \mid d\varphi = 0\}$$

self-dual & anti-self-dual harmonic forms.

One can choose a basis for \mathcal{H}_g^\pm that depends continuously on g in the $C^{1,\alpha}$ topology.

Hodge theory:

$$H^2(M, \mathbb{R}) = \{\varphi \in \Gamma(\Lambda^2) \mid d\varphi = 0, d * \varphi = 0\}.$$

Since $*$ is involution of RHS, \implies

$$H^2(M, \mathbb{R}) = \mathcal{H}_g^+ \oplus \mathcal{H}_g^-,$$

where

$$\mathcal{H}_g^\pm = \{\varphi \in \Gamma(\Lambda^\pm) \mid d\varphi = 0\}$$

self-dual & anti-self-dual harmonic forms.

One can choose a basis for \mathcal{H}_g^\pm that depends continuously on g in the $C^{1,\alpha}$ topology.

In particular, the numbers

$$b_\pm(M) = \dim \mathcal{H}_g^\pm$$

are independent of g , and so are invariants of M .

$b_{\pm}(M)?$

Best understood in terms of intersection pairing

Best understood in terms of intersection pairing

$$\begin{aligned} H^2(M, \mathbb{R}) \times H^2(M, \mathbb{R}) &\longrightarrow \mathbb{R} \\ ([\varphi], [\psi]) &\longmapsto \int_M \varphi \wedge \psi \end{aligned}$$

Best understood in terms of intersection pairing

$$\begin{aligned} H^2(M, \mathbb{R}) \times H^2(M, \mathbb{R}) &\longrightarrow \mathbb{R} \\ ([\varphi], [\psi]) &\longmapsto \int_M \varphi \wedge \psi \end{aligned}$$

Diagonalize:

$$\begin{bmatrix} +1 & & & & & & & \\ & \dots & & & & & & \\ & & +1 & & & & & \\ & & & & & & & \\ & & & & -1 & & & \\ & & & & & \dots & & \\ & & & & & & & -1 \\ & & & & & & & & \end{bmatrix} \cdot$$

Best understood in terms of intersection pairing

$$\begin{aligned}
 H^2(M, \mathbb{R}) \times H^2(M, \mathbb{R}) &\longrightarrow \mathbb{R} \\
 ([\varphi], [\psi]) &\longmapsto \int_M \varphi \wedge \psi
 \end{aligned}$$

Diagonalize:

$$\left[\begin{array}{ccc}
 +1 & & \\
 & \dots & \\
 & & +1 \\
 \underbrace{\hspace{10em}}_{b_+(M)} & & \\
 & & -1 \\
 & \left. \begin{array}{c} \\ \\ \\ \end{array} \right\} b_-(M) & \dots \\
 & & -1
 \end{array} \right] \cdot$$

Best understood in terms of intersection pairing

$$\begin{aligned}
 H^2(M, \mathbb{R}) \times H^2(M, \mathbb{R}) &\longrightarrow \mathbb{R} \\
 ([\varphi], [\psi]) &\longmapsto \int_M \varphi \wedge \psi
 \end{aligned}$$

Diagonalize:

$$\left[\begin{array}{ccc}
 +1 & & \\
 & \dots & \\
 & & +1 \\
 \underbrace{\hspace{10em}}_{b_+(M)} & & \\
 & & -1 \\
 & \left\{ \begin{array}{c} \\ \\ \\ \end{array} \right. & \dots \\
 & & -1
 \end{array} \right] \cdot$$

$$b_2(M) = b_+(M) + b_-(M)$$

Best understood in terms of intersection pairing

$$\begin{aligned}
 H^2(M, \mathbb{R}) \times H^2(M, \mathbb{R}) &\longrightarrow \mathbb{R} \\
 ([\varphi], [\psi]) &\longmapsto \int_M \varphi \wedge \psi
 \end{aligned}$$

Diagonalize:

$$\left[\begin{array}{ccc}
 +1 & & \\
 & \dots & \\
 & & +1 \\
 \underbrace{\hspace{10em}}_{b_+(M)} & & \\
 & & -1 \\
 & \left\{ \begin{array}{c} \\ \\ \\ \end{array} \right. & \dots \\
 & & -1
 \end{array} \right] \cdot$$

$$\tau(M) = b_+(M) - b_-(M)$$

“Signature” of M .

Signature defined in terms of intersection pairing

$$\begin{aligned}
 H^2(M, \mathbb{R}) \times H^2(M, \mathbb{R}) &\longrightarrow \mathbb{R} \\
 ([\varphi], [\psi]) &\longmapsto \int_M \varphi \wedge \psi
 \end{aligned}$$

Diagonalize:

$$\left[\begin{array}{ccc}
 +1 & & \\
 & \dots & \\
 & & +1 \\
 \underbrace{\hspace{10em}}_{b_+(M)} & & \\
 & & -1 \\
 & \left. \begin{array}{c} \\ \\ \\ \end{array} \right\} b_-(M) & \dots \\
 & & -1
 \end{array} \right] \cdot$$

$$\tau(M) = b_+(M) - b_-(M)$$

Signature of M .

Signature defined in terms of intersection pairing

$$\begin{aligned} H^2(M, \mathbb{R}) \times H^2(M, \mathbb{R}) &\longrightarrow \mathbb{R} \\ ([\varphi], [\psi]) &\longmapsto \int_M \varphi \wedge \psi \end{aligned}$$

$$\tau(M) = b_+(M) - b_-(M)$$

Signature defined in terms of intersection pairing,
but also expressible as a curvature integral:

$$\tau(M) = \frac{1}{12\pi^2} \int_M (|W_+|^2 - |W_-|^2) d\mu$$

Signature defined in terms of intersection pairing,
but also expressible as a curvature integral:

$$\begin{aligned}\tau(M) &= \frac{1}{12\pi^2} \int_M \left(|W_+|^2 - |W_-|^2 \right) d\mu \\ &= \left\langle \frac{1}{3} p_1(M), [M] \right\rangle\end{aligned}$$

(Thom-Hirzebruch Signature Formula)

Signature defined in terms of intersection pairing,
but also expressible as a curvature integral:

$$\tau(M) = \frac{1}{12\pi^2} \int_M (|W_+|^2 - |W_-|^2) d\mu$$

Has major consequences in conformal geometry.

On oriented (M^4, g) ,

$$\Lambda^2 = \Lambda^+ \oplus \Lambda^-$$

Riemann curvature of g

$$\mathcal{R} : \Lambda^2 \rightarrow \Lambda^2$$

Riemann curvature of g

$$\mathcal{R} : \Lambda^2 \rightarrow \Lambda^2$$

splits into 4 irreducible pieces:

Riemann curvature of g

$$\mathcal{R} : \Lambda^2 \rightarrow \Lambda^2$$

splits into 4 irreducible pieces:

$$\mathcal{R} = \left(\begin{array}{c|c} W_+ + \frac{s}{12} & \overset{\circ}{r} \\ \hline \overset{\circ}{r} & W_- + \frac{s}{12} \end{array} \right)$$

Riemann curvature of g

$$\mathcal{R} : \Lambda^2 \rightarrow \Lambda^2$$

splits into 4 irreducible pieces:

	Λ^{+*}	Λ^{-*}
Λ^+	$W_+ + \frac{s}{12}$	$\overset{\circ}{r}$
Λ^-	$\overset{\circ}{r}$	$W_- + \frac{s}{12}$

Riemann curvature of g

$$\mathcal{R} : \Lambda^2 \rightarrow \Lambda^2$$

splits into 4 irreducible pieces:

	Λ^{+*}	Λ^{-*}
Λ^+	$W_+ + \frac{s}{12}$	$\overset{\circ}{r}$
Λ^-	$\overset{\circ}{r}$	$W_- + \frac{s}{12}$

where

s = scalar curvature

$\overset{\circ}{r}$ = trace-free Ricci curvature

W_+ = self-dual Weyl curvature

W_- = anti-self-dual Weyl curvature

Riemann curvature of g

$$\mathcal{R} : \Lambda^2 \rightarrow \Lambda^2$$

splits into 4 irreducible pieces:

	Λ^{+*}	Λ^{-*}
Λ^+	$W_+ + \frac{s}{12}$	$\overset{\circ}{r}$
Λ^-	$\overset{\circ}{r}$	$W_- + \frac{s}{12}$

where

s = scalar curvature

$\overset{\circ}{r}$ = trace-free Ricci curvature

W_+ = self-dual Weyl curvature (*conformally invariant*)

W_- = anti-self-dual Weyl curvature //

For M^4 compact,

For M^4 compact, the Weyl functional

$$\mathcal{W}([g]) = \int_M (|W_+|^2 + |W_-|^2) d\mu_g$$

For M^4 compact, the Weyl functional

$$\mathcal{W}([g]) = \int_M (|W_+|^2 + |W_-|^2) d\mu_g$$

measures the deviation from conformal flatness,

For M^4 compact, the Weyl functional

$$\mathcal{W}([g]) = \int_M (|W_+|^2 + |W_-|^2) d\mu_g$$

measures the deviation from conformal flatness, because (M^4, g) is locally conformally flat \iff its Weyl curvature $W = W_+ + W_-$ vanishes.

For M^4 compact, the Weyl functional

$$\mathcal{W}([g]) = \int_M (|W_+|^2 + |W_-|^2) d\mu_g$$

measures the deviation from conformal flatness, because (M^4, g) is locally conformally flat \iff its Weyl curvature $W = W_+ + W_-$ vanishes.



For M^4 compact, the Weyl functional

$$\mathcal{W}([g]) = \int_M (|W_+|^2 + |W_-|^2) d\mu_g$$

measures the deviation from conformal flatness, because (M^4, g) is locally conformally flat \iff its Weyl curvature $W = W_+ + W_-$ vanishes.

For M^4 compact, the Weyl functional

$$\mathcal{W}([g]) = \int_M (|W_+|^2 + |W_-|^2) d\mu_g$$

measures the deviation from conformal flatness, because (M^4, g) is locally conformally flat \iff its Weyl curvature $W = W_+ + W_-$ vanishes.

Basic problems: For given smooth compact M^4 ,

For M^4 compact, the Weyl functional

$$\mathcal{W}([g]) = \int_M (|W_+|^2 + |W_-|^2) d\mu_g$$

measures the deviation from conformal flatness, because (M^4, g) is locally conformally flat \iff its Weyl curvature $W = W_+ + W_-$ vanishes.

Basic problems: For given smooth compact M^4 ,

- What is $\inf \mathcal{W}$?

For M^4 compact, the Weyl functional

$$\mathcal{W}([g]) = \int_M (|W_+|^2 + |W_-|^2) d\mu_g$$

measures the deviation from conformal flatness, because (M^4, g) is locally conformally flat \iff its Weyl curvature $W = W_+ + W_-$ vanishes.

Basic problems: For given smooth compact M^4 ,

- What is $\inf \mathcal{W}$?
- Do there exist minimizers?

For M^4 compact, the Weyl functional

$$\mathcal{W}([g]) = \int_M \left(|W_+|^2 + |W_-|^2 \right) d\mu_g$$

measures the deviation from conformal flatness, because (M^4, g) is locally conformally flat \iff its Weyl curvature $W = W_+ + W_-$ vanishes.

But we've already noted that

$$12\pi^2 \tau(M) = \int_M \left(|W_+|^2 - |W_-|^2 \right) d\mu_g$$

is a topological invariant.

For M^4 compact, the Weyl functional

$$\mathcal{W}([g]) = \int_M \left(|W_+|^2 + |W_-|^2 \right) d\mu_g$$

measures the deviation from conformal flatness, because (M^4, g) is locally conformally flat \iff its Weyl curvature $W = W_+ + W_-$ vanishes.

But we've already noted that

$$12\pi^2 \tau(M) = \int_M \left(|W_+|^2 - |W_-|^2 \right) d\mu_g$$

is a topological invariant.

So Weyl functional is essentially equivalent to

$$[g] \longmapsto \int_M |W_+|^2 d\mu_g$$

For M^4 compact, the Weyl functional

$$\mathcal{W}([g]) = \int_M \left(|W_+|^2 + |W_-|^2 \right) d\mu_g$$

measures the deviation from conformal flatness, because (M^4, g) is locally conformally flat \iff its Weyl curvature $W = W_+ + W_-$ vanishes.

But we've already noted that

$$12\pi^2 \tau(M) = \int_M \left(|W_+|^2 - |W_-|^2 \right) d\mu_g$$

is a topological invariant.

In particular, metrics with $W_+ \equiv 0$ minimize \mathcal{W} .

For M^4 compact, the Weyl functional

$$\mathcal{W}([g]) = \int_M \left(|W_+|^2 + |W_-|^2 \right) d\mu_g$$

measures the deviation from conformal flatness, because (M^4, g) is locally conformally flat \iff its Weyl curvature $W = W_+ + W_-$ vanishes.

But we've already noted that

$$12\pi^2 \tau(M) = \int_M \left(|W_+|^2 - |W_-|^2 \right) d\mu_g$$

is a topological invariant.

In particular, metrics with $W_+ \equiv 0$ minimize \mathcal{W} .

If g has $W_+ \equiv 0$, it is said to be anti-self-dual.

For M^4 compact, the Weyl functional

$$\mathcal{W}([g]) = \int_M \left(|W_+|^2 + |W_-|^2 \right) d\mu_g$$

measures the deviation from conformal flatness, because (M^4, g) is locally conformally flat \iff its Weyl curvature $W = W_+ + W_-$ vanishes.

But we've already noted that

$$12\pi^2 \tau(M) = \int_M \left(|W_+|^2 - |W_-|^2 \right) d\mu_g$$

is a topological invariant.

In particular, metrics with $W_+ \equiv 0$ minimize \mathcal{W} .

If g has $W_+ \equiv 0$, it is said to be anti-self-dual.

(ASD)

Twistor picture of anti-self-duality condition:

Twistor picture of anti-self-duality condition:

Oriented $(M^4, g) \longleftrightarrow (Z, J)$.

Twistor picture of anti-self-duality condition:

Oriented $(M^4, g) \longleftrightarrow (Z, J)$.

$Z = S(\Lambda^+)$, $J : TZ \rightarrow TZ$, $J^2 = -1$:

Twistor picture of anti-self-duality condition:

Oriented $(M^4, g) \longleftrightarrow (Z, J)$.

$Z = S(\Lambda^+)$, $J : TZ \rightarrow TZ$, $J^2 = -1$:

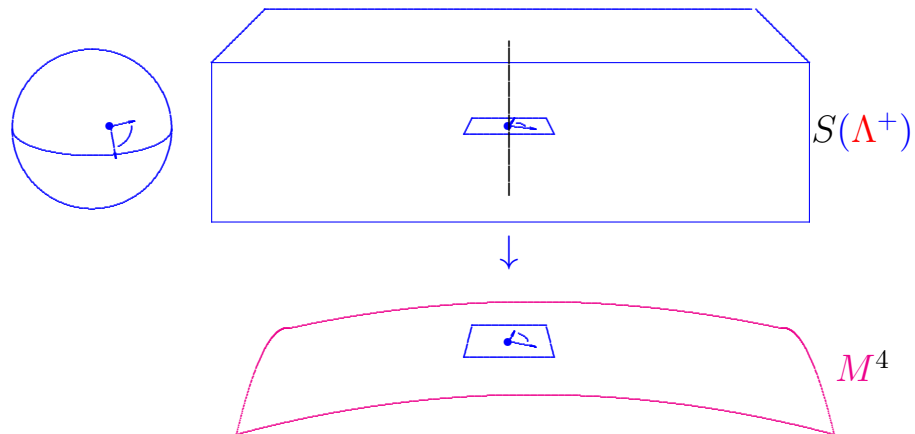

Twistor picture of anti-self-duality condition:

Oriented $(M^4, g) \longleftrightarrow (Z, J)$.

$Z = S(\Lambda^+)$, $J : TZ \rightarrow TZ$, $J^2 = -1$:

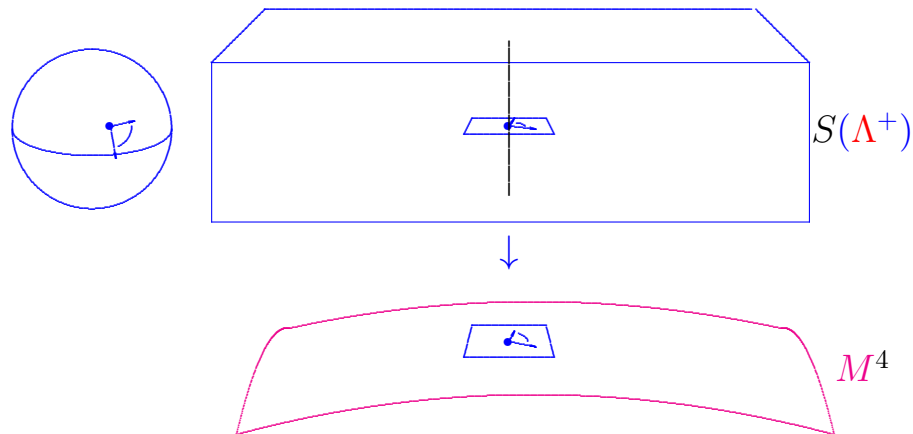

Theorem (Atiyah-Hitchin-Singer). (Z, J) is a complex 3-manifold iff $W_+ = 0$.

Twistor picture of anti-self-duality condition:

Oriented $(M^4, g) \longleftrightarrow (Z, J)$.

$Z = S(\Lambda^+)$, $J : TZ \rightarrow TZ$, $J^2 = -1$:

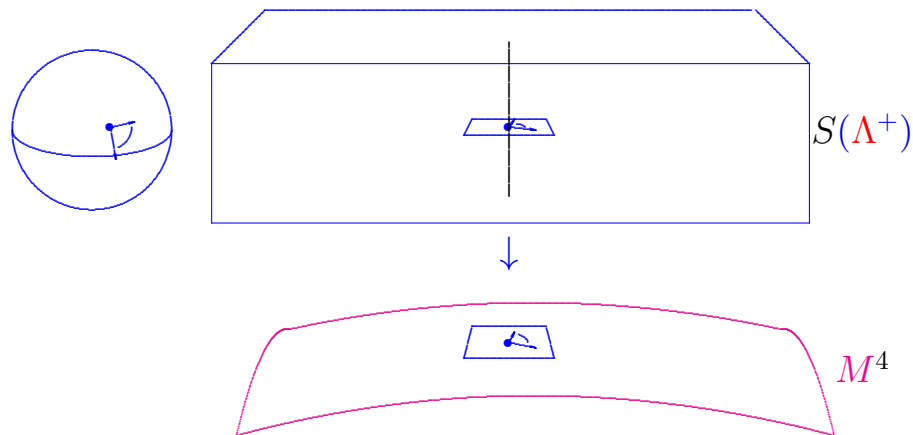

Theorem (Atiyah-Hitchin-Singer). (Z, J) is a complex 3-manifold iff $W_+ = 0$.

Reconceptualizes earlier work by Penrose.

Twistor picture of anti-self-duality condition:

Oriented $(M^4, g) \longleftrightarrow (Z, J)$.

$Z = S(\Lambda^+)$, $J : TZ \rightarrow TZ$, $J^2 = -1$:

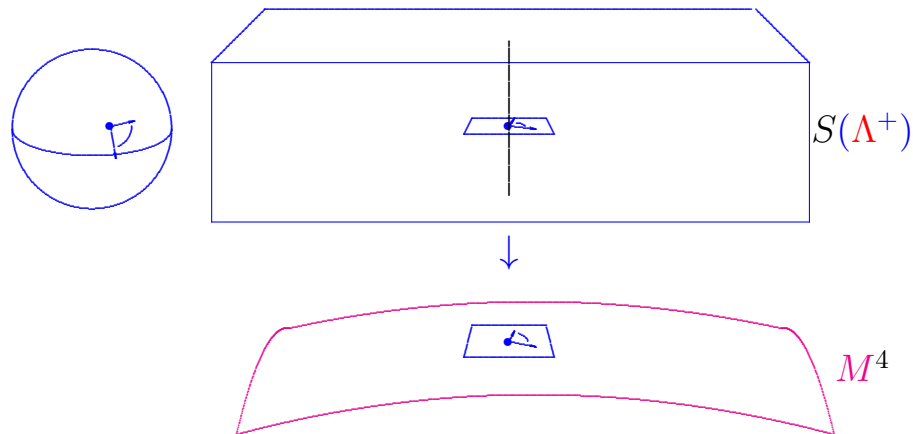

Theorem (Atiyah-Hitchin-Singer). (Z, J) is a complex 3-manifold iff $W_+ = 0$.

Twistor picture of anti-self-duality condition:

Oriented $(M^4, g) \longleftrightarrow (Z, J)$.

$Z = S(\Lambda^+)$, $J : TZ \rightarrow TZ$, $J^2 = -1$:

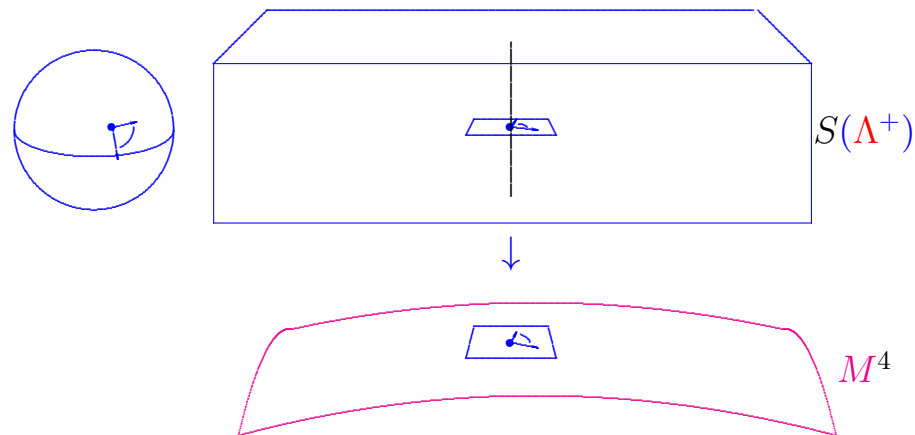

Theorem (Atiyah-Hitchin-Singer). (Z, J) is a complex 3-manifold iff $W_+ = 0$.

Motivates study of ASD metrics,
and yields methods for constructing them.

So ASD metrics are linked to complex geometry. . .

A different link with complex geometry:

A different link with complex geometry:

If (M^4, g, J) is a Kähler surface,

A different link with complex geometry:

If (M^4, g, J) is a Kähler surface, then $[g]$ is ASD
 \iff the scalar curvature s of g is identically zero.

A different link with complex geometry:

If (M^4, g, J) is a Kähler surface, then $[g]$ is ASD
 \iff the scalar curvature s of g is identically zero.

Scalar-flat Kähler surfaces:

A different link with complex geometry:

If (M^4, g, J) is a Kähler surface, then $[g]$ is ASD
 \iff the scalar curvature s of g is identically zero.

Scalar-flat Kähler surfaces:
special case of cscK manifolds,

A different link with complex geometry:

If (M^4, g, J) is a Kähler surface, then $[g]$ is ASD
 \iff the scalar curvature s of g is identically zero.

Scalar-flat Kähler surfaces:

special case of cscK manifolds,
and so of extremal Kähler manifolds.

A different link with complex geometry:

If (M^4, g, J) is a Kähler surface, then $[g]$ is ASD
 \iff the scalar curvature s of g is identically zero.

Scalar-flat Kähler surfaces:

special case of cscK manifolds,
and so of extremal Kähler manifolds.

Results proved about SFK in '90s foreshadowed
many more recent results about general case.

A different link with complex geometry:

If (M^4, g, J) is a Kähler surface, then $[g]$ is ASD
 \iff the scalar curvature s of g is identically zero.

Scalar-flat Kähler surfaces:

A different link with complex geometry:

If (M^4, g, J) is a Kähler surface, then $[g]$ is ASD
 \iff the scalar curvature s of g is identically zero.

Scalar-flat Kähler surfaces:

Classification up to diffeomorphism:

A different link with complex geometry:

If (M^4, g, J) is a Kähler surface, then $[g]$ is ASD
 \iff the scalar curvature s of g is identically zero.

Scalar-flat Kähler surfaces:

Classification up to diffeomorphism: (compact case)

A different link with complex geometry:

If (M^4, g, J) is a Kähler surface, then $[g]$ is ASD
 \iff the scalar curvature s of g is identically zero.

Scalar-flat Kähler surfaces:

Classification up to diffeomorphism:

A different link with complex geometry:

If (M^4, g, J) is a Kähler surface, then $[g]$ is ASD
 \iff the scalar curvature s of g is identically zero.

Scalar-flat Kähler surfaces:

Classification up to diffeomorphism:

- Ricci-flat case

A different link with complex geometry:

If (M^4, g, J) is a Kähler surface, then $[g]$ is ASD
 \iff the scalar curvature s of g is identically zero.

Scalar-flat Kähler surfaces:

Classification up to diffeomorphism:

- Ricci-flat case
- Non-Ricci-flat case

A different link with complex geometry:

If (M^4, g, J) is a Kähler surface, then $[g]$ is ASD
 \iff the scalar curvature s of g is identically zero.

Scalar-flat Kähler surfaces:

Classification up to diffeomorphism:

- Ricci-flat case
 -
 -
 -
- Non-Ricci-flat case

A different link with complex geometry:

If (M^4, g, J) is a Kähler surface, then $[g]$ is ASD
 \iff the scalar curvature s of g is identically zero.

Scalar-flat Kähler surfaces:

Classification up to diffeomorphism:

- Ricci-flat case
 - $K3$
 -
 -
- Non-Ricci-flat case

A different link with complex geometry:

If (M^4, g, J) is a Kähler surface, then $[g]$ is ASD
 \iff the scalar curvature s of g is identically zero.

Scalar-flat Kähler surfaces:

Classification up to diffeomorphism:

- Ricci-flat case
 - $K3$
 - T^4
 -
- Non-Ricci-flat case

A different link with complex geometry:

If (M^4, g, J) is a Kähler surface, then $[g]$ is ASD
 \iff the scalar curvature s of g is identically zero.

Scalar-flat Kähler surfaces:

Classification up to diffeomorphism:

- Ricci-flat case
 - $K3$
 - T^4
 - eight specific finite quotients of these
- Non-Ricci-flat case

A different link with complex geometry:

If (M^4, g, J) is a Kähler surface, then $[g]$ is ASD
 \iff the scalar curvature s of g is identically zero.

Scalar-flat Kähler surfaces:

Classification up to diffeomorphism:

- Ricci-flat case (ignore from now on)
 - $K3$
 - T^4
 - eight specific finite quotients of these
- Non-Ricci-flat case

A different link with complex geometry:

If (M^4, g, J) is a Kähler surface, then $[g]$ is ASD
 \iff the scalar curvature s of g is identically zero.

Scalar-flat Kähler surfaces:

Classification up to diffeomorphism:

- Ricci-flat case
- Non-Ricci-flat case

A different link with complex geometry:

If (M^4, g, J) is a Kähler surface, then $[g]$ is ASD
 \iff the scalar curvature s of g is identically zero.

Scalar-flat Kähler surfaces:

Classification up to diffeomorphism:

- Ricci-flat case
- Non-Ricci-flat case

—

—

—

—

A different link with complex geometry:

If (M^4, g, J) is a Kähler surface, then $[g]$ is ASD
 \iff the scalar curvature s of g is identically zero.

Scalar-flat Kähler surfaces:

Classification up to diffeomorphism:

- Ricci-flat case
- Non-Ricci-flat case
 - $\mathbb{C}P_2 \# k \overline{\mathbb{C}P}_2, k \geq 10$
 -
 -
 -

Convention:

$\overline{\mathbb{C}P}_2$ = reverse oriented $\mathbb{C}P_2$.

Convention:

$\overline{\mathbb{C}P}_2$ = reverse oriented $\mathbb{C}P_2$.

Connected sum #:

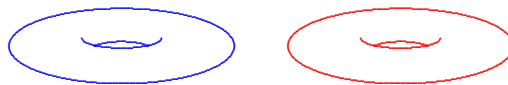

Convention:

$\overline{\mathbb{C}P}_2$ = reverse oriented $\mathbb{C}P_2$.

Connected sum #:

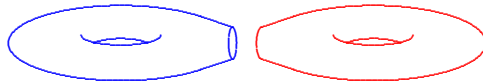

Convention:

$\overline{\mathbb{C}P}_2$ = reverse oriented $\mathbb{C}P_2$.

Connected sum #:

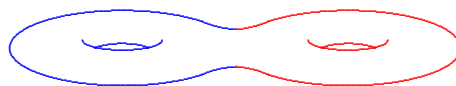

Convention:

$\overline{\mathbb{C}P}_2$ = reverse oriented $\mathbb{C}P_2$.

Connected sum #:

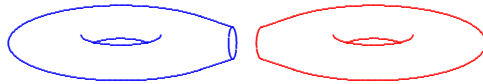

Convention:

$\overline{\mathbb{C}P}_2$ = reverse oriented $\mathbb{C}P_2$.

Connected sum #:

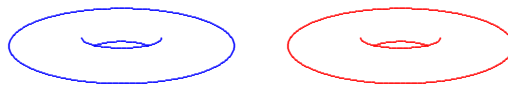

Convention:

$\overline{\mathbb{C}P}_2$ = reverse oriented $\mathbb{C}P_2$.

Connected sum #:

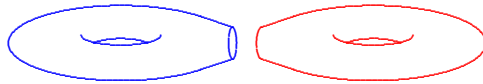

Convention:

$\overline{\mathbb{C}P}_2$ = reverse oriented $\mathbb{C}P_2$.

Connected sum #:

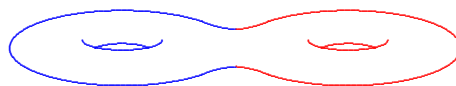

Convention:

$\overline{\mathbb{C}P}_2$ = reverse oriented $\mathbb{C}P_2$.

Connected sum #:

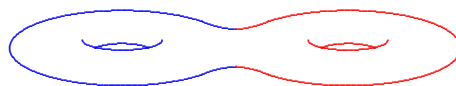

Convention:

$\overline{\mathbb{C}P}_2$ = reverse oriented $\mathbb{C}P_2$.

Connected sum #:

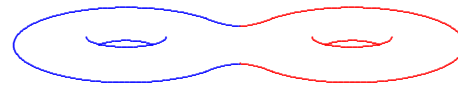

Blowing Up: $M \rightsquigarrow M \# \overline{\mathbb{C}P}_2$

Convention:

$\overline{\mathbb{C}P}_2$ = reverse oriented $\mathbb{C}P_2$.

Connected sum #:

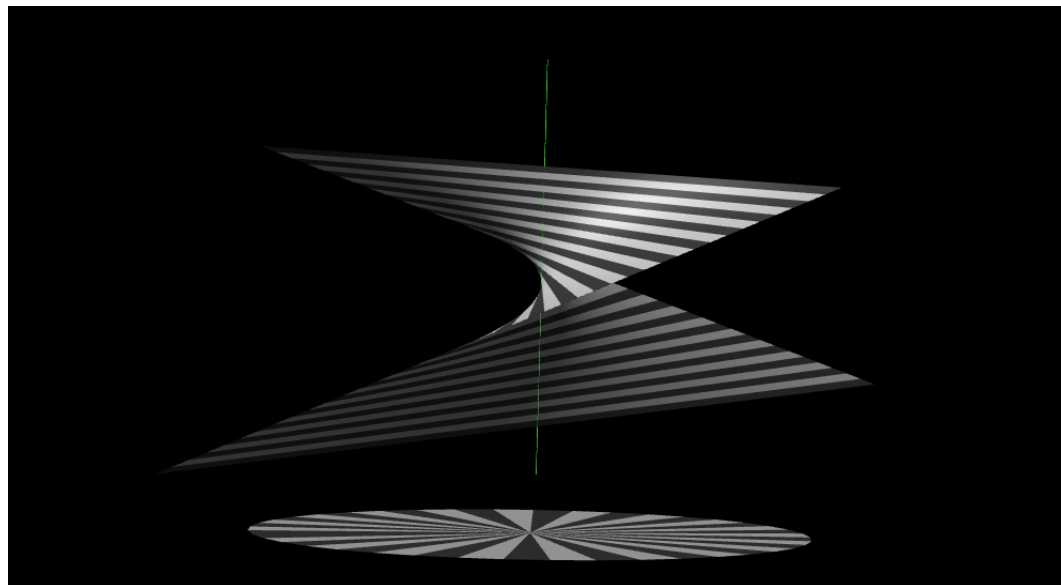
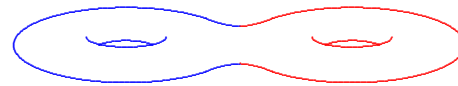

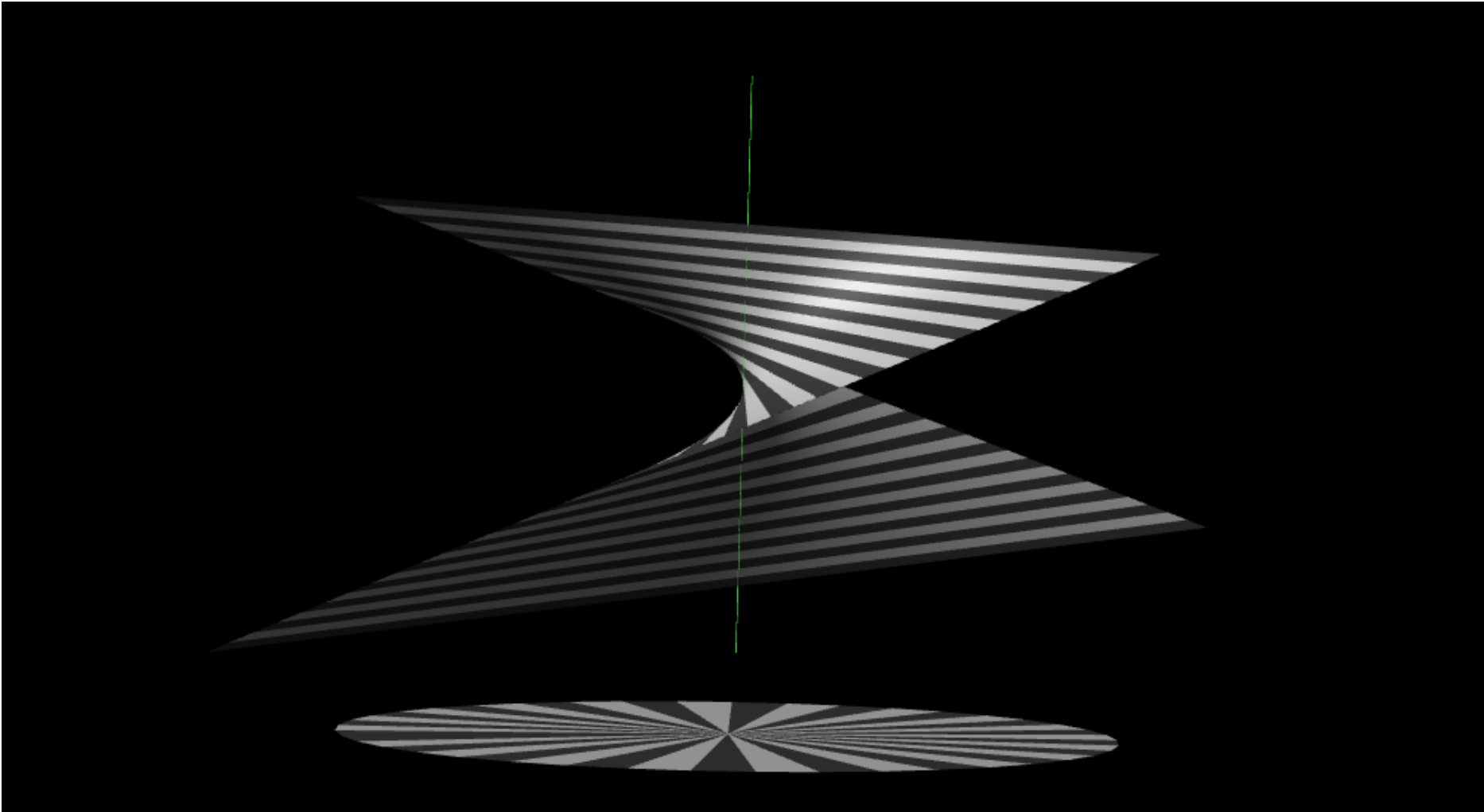

Convention:

$\overline{\mathbb{C}P}_2$ = reverse oriented $\mathbb{C}P_2$.

Connected sum #:

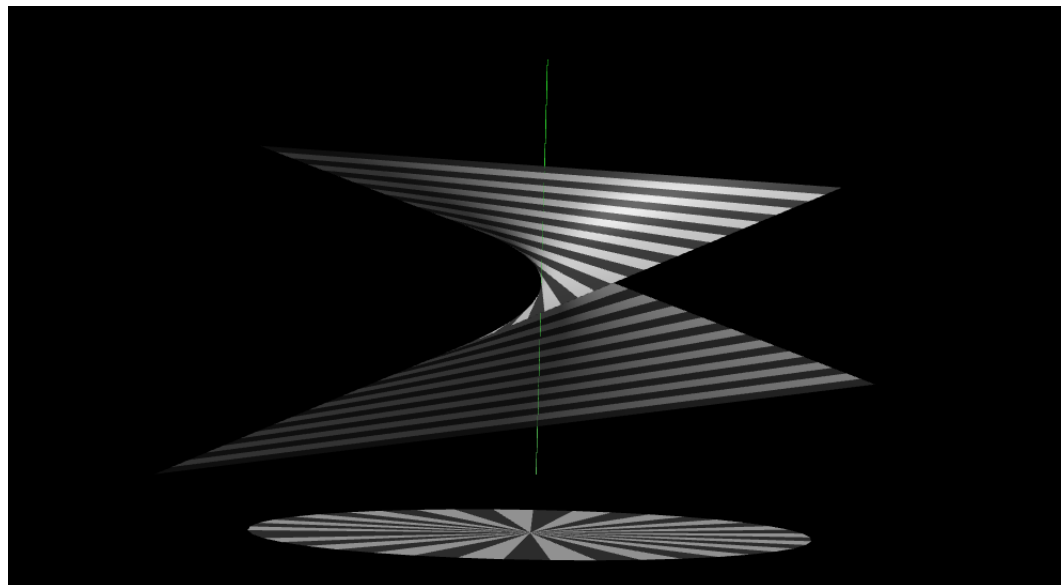
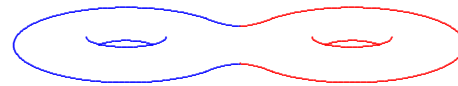

Convention:

$\overline{\mathbb{C}P}_2$ = reverse oriented $\mathbb{C}P_2$.

Connected sum #:

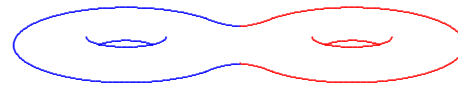

Blowing Up: $M \rightsquigarrow M \# \overline{\mathbb{C}P}_2$

A different link with complex geometry:

If (M^4, g, J) is a Kähler surface, then $[g]$ is ASD
 \iff the scalar curvature s of g is identically zero.

Scalar-flat Kähler surfaces:

Classification up to diffeomorphism:

- Ricci-flat case
- Non-Ricci-flat case
 - $\mathbb{C}P_2 \# k \overline{\mathbb{C}P}_2, k \geq 10$
 -
 -
 -

A different link with complex geometry:

If (M^4, g, J) is a Kähler surface, then $[g]$ is ASD
 \iff the scalar curvature s of g is identically zero.

Scalar-flat Kähler surfaces:

Classification up to diffeomorphism:

- Ricci-flat case
- Non-Ricci-flat case
 - $\mathbb{C}P_2 \# k \overline{\mathbb{C}P}_2, k \geq 10$
 - $(T^2 \times S^2) \# k \overline{\mathbb{C}P}_2, k \geq 1$
 -
 -

A different link with complex geometry:

If (M^4, g, J) is a Kähler surface, then $[g]$ is ASD
 \iff the scalar curvature s of g is identically zero.

Scalar-flat Kähler surfaces:

Classification up to diffeomorphism:

- Ricci-flat case
- Non-Ricci-flat case
 - $\mathbb{C}P_2 \# k \overline{\mathbb{C}P_2}$, $k \geq 10$
 - $(T^2 \times S^2) \# k \overline{\mathbb{C}P_2}$, $k \geq 1$
 - $\Sigma \times S^2$
 -

A different link with complex geometry:

If (M^4, g, J) is a Kähler surface, then $[g]$ is ASD
 \iff the scalar curvature s of g is identically zero.

Scalar-flat Kähler surfaces:

Classification up to diffeomorphism:

- Ricci-flat case
- Non-Ricci-flat case
 - $\mathbb{C}P_2 \# k \overline{\mathbb{C}P_2}$, $k \geq 10$
 - $(T^2 \times S^2) \# k \overline{\mathbb{C}P_2}$, $k \geq 1$
 - $\Sigma \times S^2$ and $\Sigma \tilde{\times} S^2$,
 -

A different link with complex geometry:

If (M^4, g, J) is a Kähler surface, then $[g]$ is ASD
 \iff the scalar curvature s of g is identically zero.

Scalar-flat Kähler surfaces:

Classification up to diffeomorphism:

- Ricci-flat case
- Non-Ricci-flat case
 - $\mathbb{C}P_2 \# k \overline{\mathbb{C}P_2}$, $k \geq 10$
 - $(T^2 \times S^2) \# k \overline{\mathbb{C}P_2}$, $k \geq 1$
 - $\Sigma \times S^2$ and $\Sigma \tilde{\times} S^2$, genus $\Sigma \geq 2$
 -

A different link with complex geometry:

If (M^4, g, J) is a Kähler surface, then $[g]$ is ASD
 \iff the scalar curvature s of g is identically zero.

Scalar-flat Kähler surfaces:

Classification up to diffeomorphism:

- Ricci-flat case
- Non-Ricci-flat case
 - $\mathbb{C}P_2 \# k \overline{\mathbb{C}P_2}$, $k \geq 10$
 - $(T^2 \times S^2) \# k \overline{\mathbb{C}P_2}$, $k \geq 1$
 - $\Sigma \times S^2$ and $\Sigma \tilde{\times} S^2$, genus $\Sigma \geq 2$
 - $(\Sigma \times S^2) \# k \overline{\mathbb{C}P_2}$, $k \geq 1$

Notice that the 4-manifolds $\mathbb{C}P_2 \# k \overline{\mathbb{C}P_2}$

Notice that the 4-manifolds $\mathbb{C}P_2 \#^k \overline{\mathbb{C}P_2}$
do not admit scalar-flat Kähler metrics when $k \leq 9$.

Notice that the 4-manifolds $\mathbb{C}P_2 \#^k \overline{\mathbb{C}P_2}$
do not admit scalar-flat Kähler metrics when $k \leq 9$.

Plausible conjecture:

Notice that the 4-manifolds $\mathbb{C}P_2 \#^k \overline{\mathbb{C}P_2}$
do not admit scalar-flat Kähler metrics when $k \leq 9$.

Plausible conjecture:

these manifolds don't admit any ASD metrics.

Notice that the 4-manifolds $\mathbb{C}P_2 \#^k \overline{\mathbb{C}P_2}$
do not admit scalar-flat Kähler metrics when $k \leq 9$.

Plausible conjecture:

these manifolds don't admit any ASD metrics.

Stronger conjecture:

Notice that the 4-manifolds $\mathbb{C}P_2 \#^k \overline{\mathbb{C}P_2}$
do not admit scalar-flat Kähler metrics when $k \leq 9$.

Plausible conjecture:

these manifolds don't admit any ASD metrics.

Stronger conjecture:

any metric on one of these manifolds satisfies

$$\int_M |W_+|^2 d\mu \geq \frac{4\pi^2}{3}(9 - k)$$

Notice that the 4-manifolds $\mathbb{C}P_2 \#^k \overline{\mathbb{C}P_2}$
do not admit scalar-flat Kähler metrics when $k \leq 9$.

Plausible conjecture:

these manifolds don't admit any ASD metrics.

Stronger conjecture:

any metric on one of these manifolds M satisfies

$$\int_M |W_+|^2 d\mu \geq \frac{4\pi^2}{3} (2\chi + 3\tau)(M)$$

Notice that the 4-manifolds $\mathbb{C}P_2 \#^k \overline{\mathbb{C}P_2}$
do not admit scalar-flat Kähler metrics when $k \leq 9$.

Plausible conjecture:

these manifolds don't admit any ASD metrics.

Stronger conjecture:

any metric on one of these manifolds M satisfies

$$\int_M |W_+|^2 d\mu \geq \frac{4\pi^2}{3} (2\chi + 3\tau)(M)$$

with equality iff g conformal to Kähler-Einstein.

Notice that the 4-manifolds $\mathbb{C}P_2 \#^k \overline{\mathbb{C}P_2}$
do not admit scalar-flat Kähler metrics when $k \leq 9$.

Plausible conjecture:

these manifolds don't admit any ASD metrics.

Stronger conjecture:

any metric on one of these manifolds M satisfies

$$\int_M |W_+|^2 d\mu \geq \frac{4\pi^2}{3} (2\chi + 3\tau)(M)$$

Theorem (Gursky '98). *True for conformal classes
of positive Yamabe constant.*

Notice that the 4-manifolds $\mathbb{C}P_2 \#^k \overline{\mathbb{C}P_2}$ do not admit scalar-flat Kähler metrics when $k \leq 9$.

Plausible conjecture:

these manifolds don't admit any ASD metrics.

Stronger conjecture:

any metric on one of these manifolds M satisfies

$$\int_M |W_+|^2 d\mu \geq \frac{4\pi^2}{3} (2\chi + 3\tau)(M)$$

Theorem (Gursky '98). *True for conformal classes of positive Yamabe constant.*

Theorem (L '15). *True for conformal classes of symplectic type.*

$$\int_M |W_+|^2 d\mu \geq \frac{4\pi^2}{3} (2\chi + 3\tau)(M)$$

Theorem (L '15). *True for conformal classes of symplectic type.*

$$\left(\int |W_+|^2 d\mu \right)^{1/2} \geq \frac{2\pi c_1 \cdot [\omega]}{\sqrt{3}[\omega]^2}$$

$$\int_M |W_+|^2 d\mu \geq \frac{4\pi^2}{3} (2\chi + 3\tau)(M)$$

Theorem (L '15). *True for conformal classes of symplectic type.*

Last result indicates that almost-Kähler condition gives extra control on ASD conformal geometry.

Last result indicates that almost-Kähler condition gives extra control on ASD conformal geometry.

Inyoung Kim '16: classification of almost-Kähler ASD roughly the same as in scalar-flat Kähler case.

Last result indicates that almost-Kähler condition gives extra control on ASD conformal geometry.

Inyoung Kim '16: classification of almost-Kähler ASD roughly the same as in scalar-flat Kähler case.

Does this say anything about general ASD metrics?

Last result indicates that almost-Kähler condition gives extra control on ASD conformal geometry.

Inyoung Kim '16: classification of almost-Kähler ASD roughly the same as in scalar-flat Kähler case.

Does this say anything about general ASD metrics?

Almost-Kähler ASD metrics sweep out an open set in the ASD moduli space.

Example.

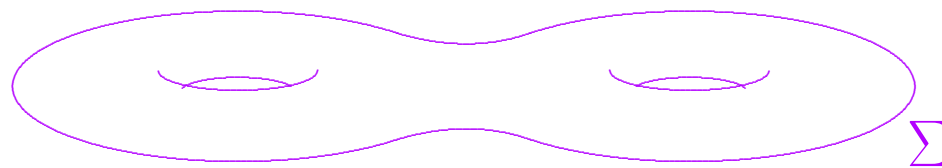

Example.

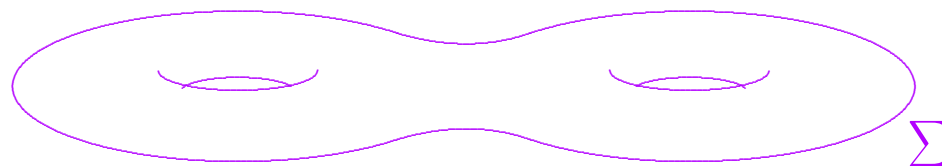
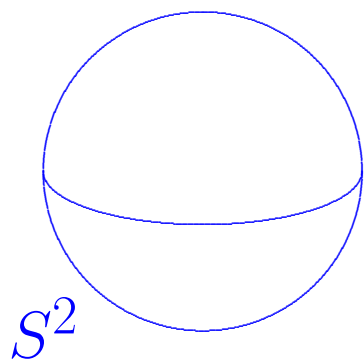

Example.

$$M = \Sigma \times S^2$$

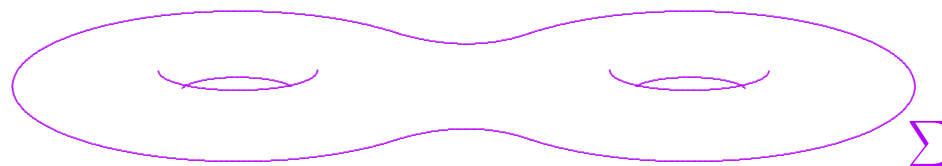
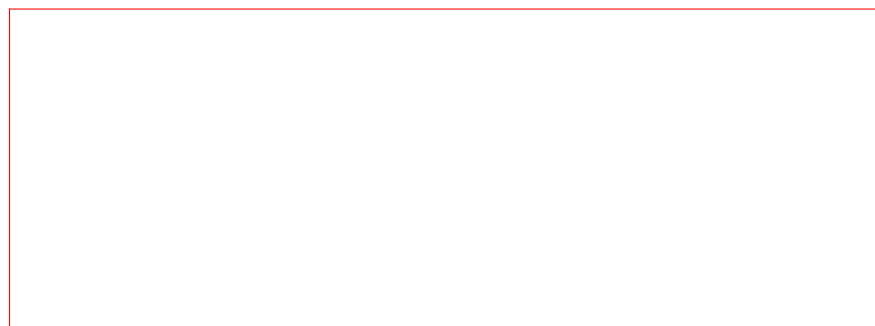
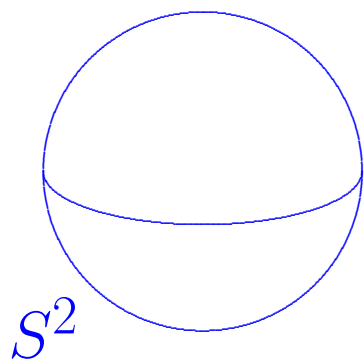

Example.

$$M = \Sigma \times S^2$$

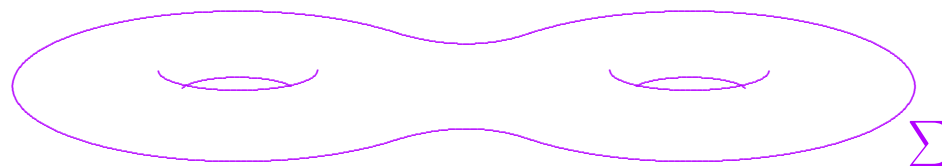
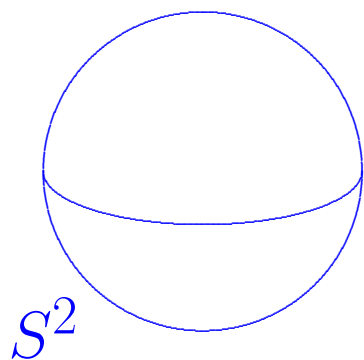

$$K = -1$$

Example.

$$K = +1$$

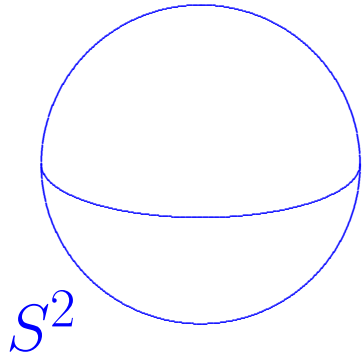

$$M = \Sigma \times S^2$$



$$K = -1$$

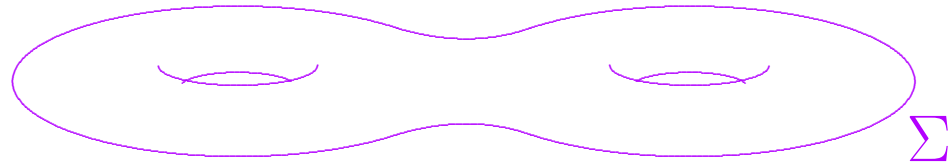

Example.

$$K = +1$$

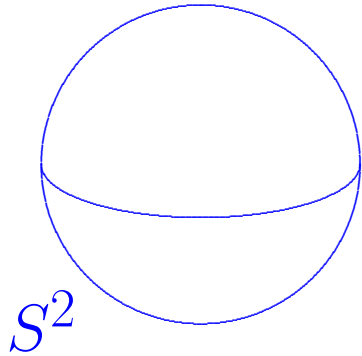

$$M = \Sigma \times S^2$$

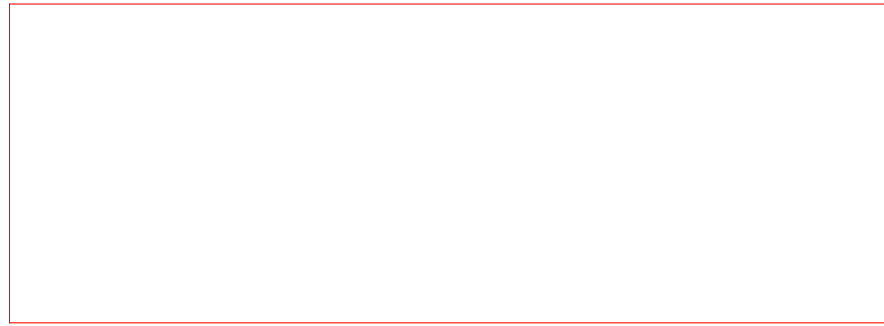

$$K = -1$$

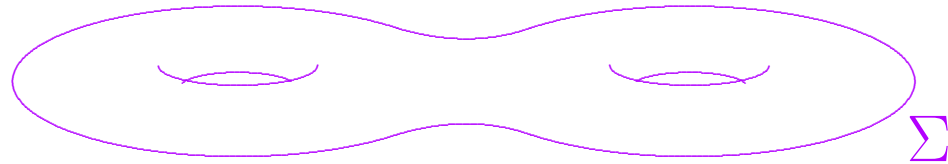

Product is scalar-flat

Example.

$$K = +1$$

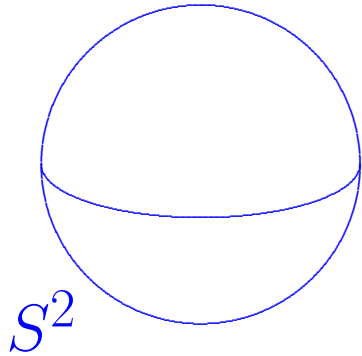

$$M = \Sigma \times S^2$$

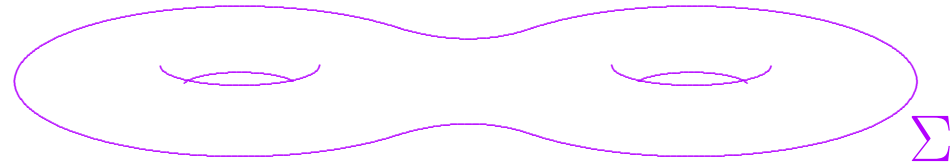

$$K = -1$$

Product is scalar-flat Kähler.

Example.

$$K = +1$$

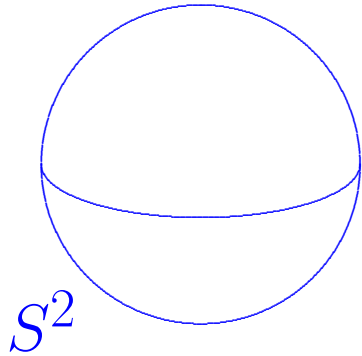

$$M = \Sigma \times S^2$$

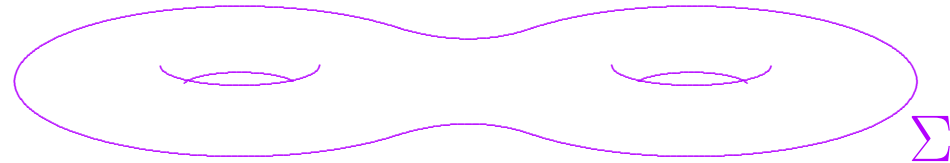

$$K = -1$$

Product is scalar-flat Kähler.

For both orientations!

Example.

$$K = +1$$

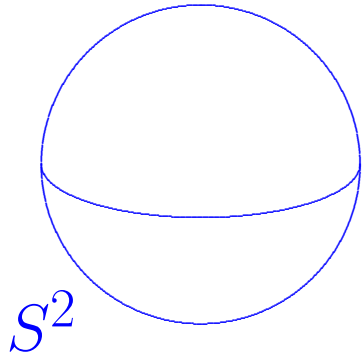

$$M = \Sigma \times S^2$$



$$K = -1$$

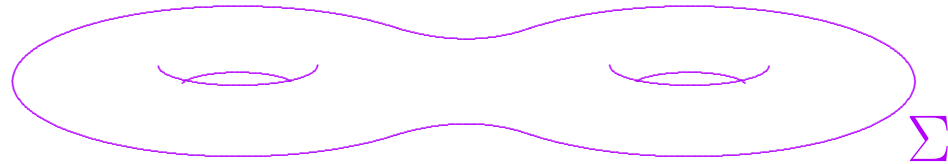

Product is scalar-flat Kähler.

For both orientations!

$$W_+ = 0.$$

Example.

$$K = +1$$

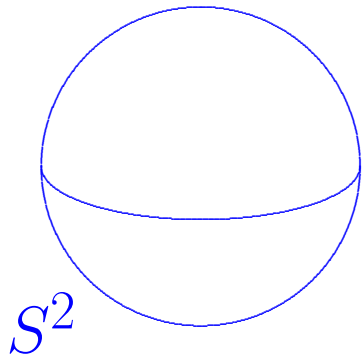

$$M = \Sigma \times S^2$$

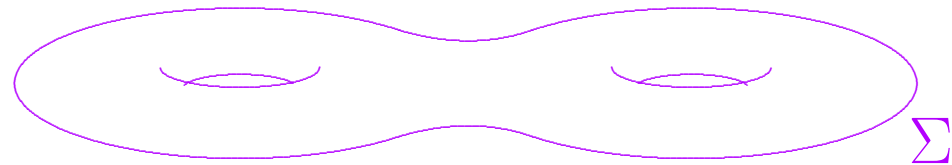
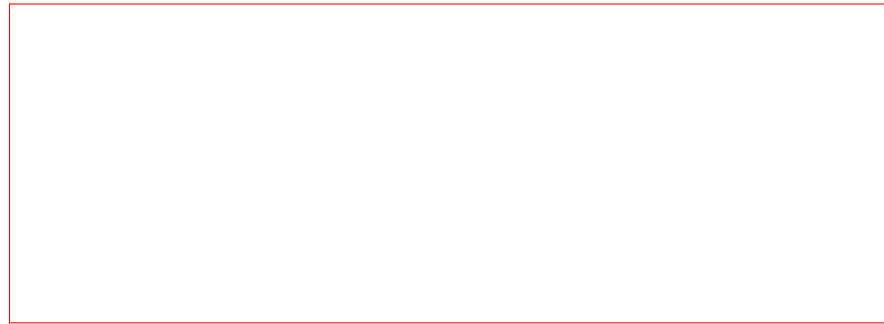

$$K = -1$$

Product is scalar-flat Kähler.

For both orientations!

$$W_{\pm} = 0.$$

Example.

$$K = +1$$

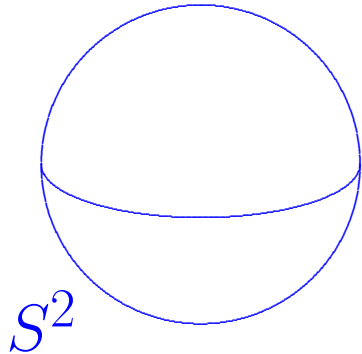

$$M = \Sigma \times S^2$$

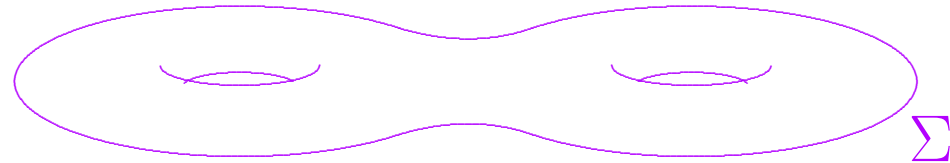

$$K = -1$$

Product is scalar-flat Kähler.

For both orientations!

$$W_{\pm} = 0.$$

Locally conformally flat!

Example.

$$K = +1$$

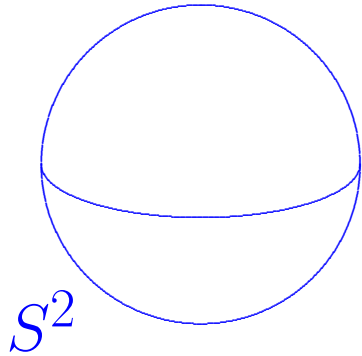

$$M = \Sigma \times S^2$$



$$K = -1$$

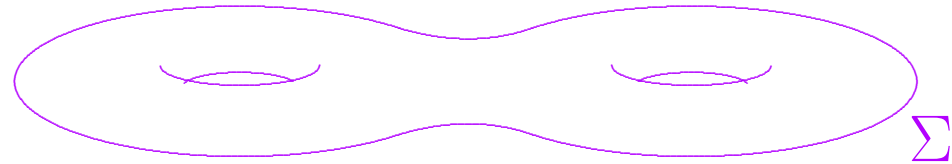

$$\widetilde{M} = \mathcal{H}^2 \times S^2$$

Example.

$$K = +1$$

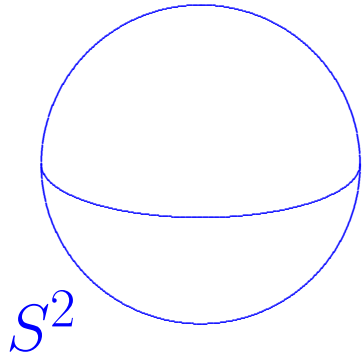

$$M = \Sigma \times S^2$$



$$K = -1$$

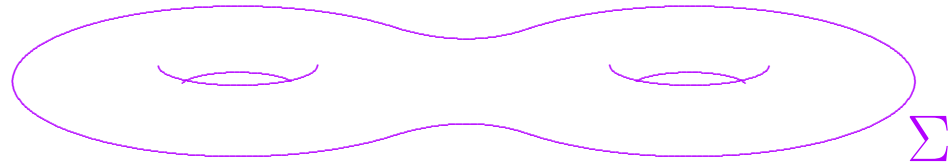

$$\widetilde{M} = \mathcal{H}^2 \times S^2 = S^4 - S^1$$

Example.

$$K = +1$$

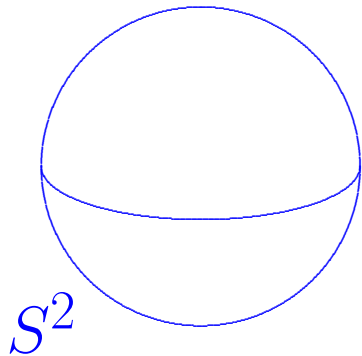

$$M = \Sigma \times S^2$$

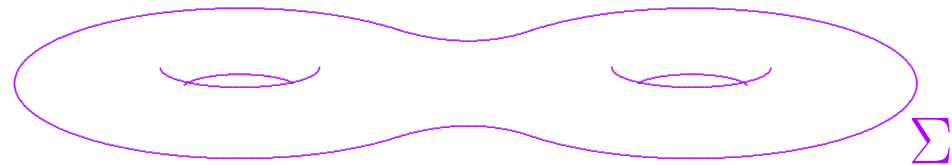

$$K = -1$$

$$\widetilde{M} = \mathcal{H}^2 \times S^2 = S^4 - S^1$$

$$\pi_1(\Sigma) \hookrightarrow \mathbf{SO}_+(1, 2)$$

Example.

$$K = +1$$

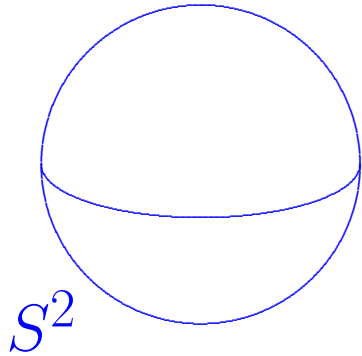

$$M = \Sigma \times S^2$$



$$K = -1$$

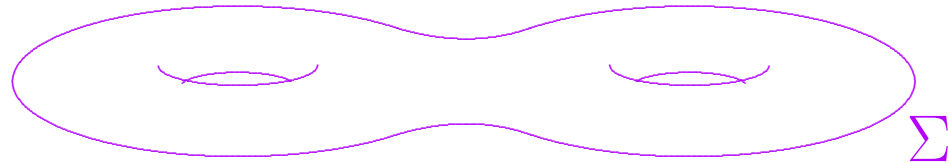

$$\widetilde{M} = \mathcal{H}^2 \times S^2 = S^4 - S^1$$

$$\pi_1(\Sigma) \hookrightarrow \mathbf{SO}_+(1, 2) \times \mathbf{SO}(3)$$

Example.

$$K = +1$$

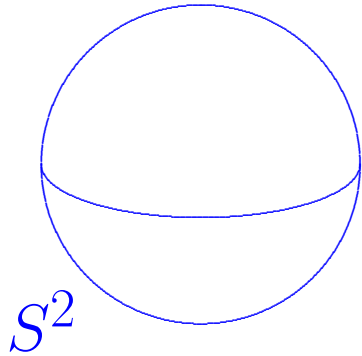

$$M = \Sigma \times S^2$$



$$K = -1$$

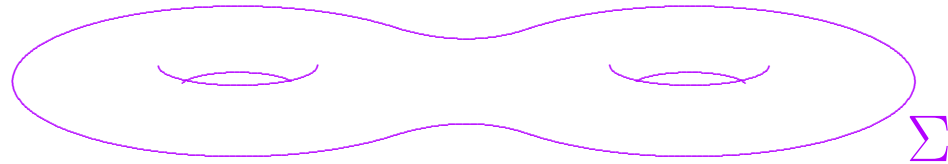

$$\widetilde{M} = \mathcal{H}^2 \times S^2 = S^4 - S^1$$

$$\pi_1(\Sigma) \hookrightarrow \mathbf{SO}_+(1, 2) \times \mathbf{SO}(3) \hookrightarrow \mathbf{SO}_+(1, 5)$$

Example.

$$K = +1$$

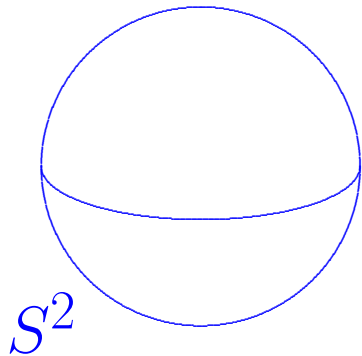

$$M = \Sigma \times S^2$$



$$K = -1$$

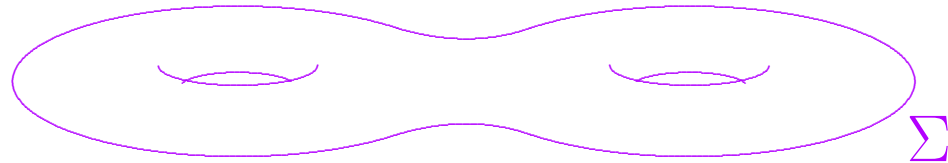

Scalar-flat Kähler deformations: $12(g - 1)$ moduli

Example.

$$K = +1$$

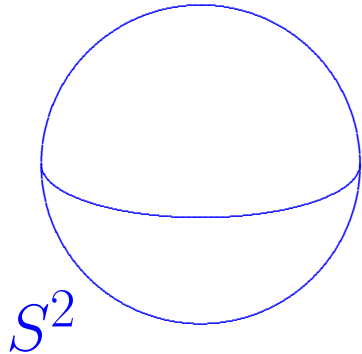

$$M = \Sigma \times S^2$$

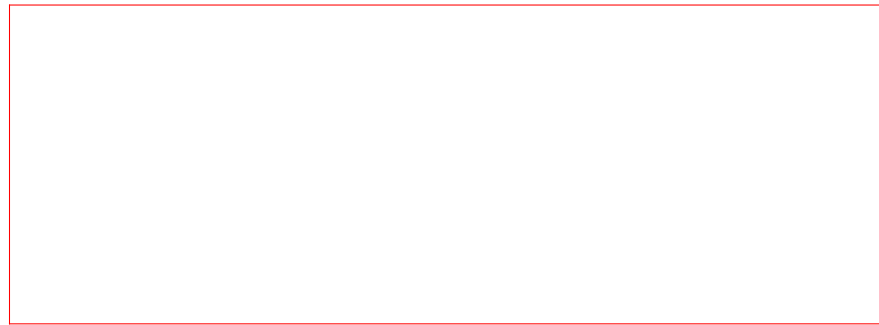

$$K = -1$$

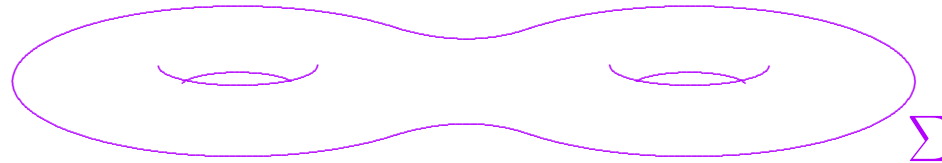

Scalar-flat Kähler deformations: $12(g - 1)$ moduli
Locally conformally flat def'ms: $30(g - 1)$ moduli

Example.

$$K = +1$$

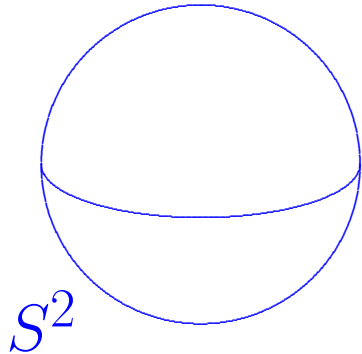

$$M = \Sigma \times S^2$$



$$K = -1$$

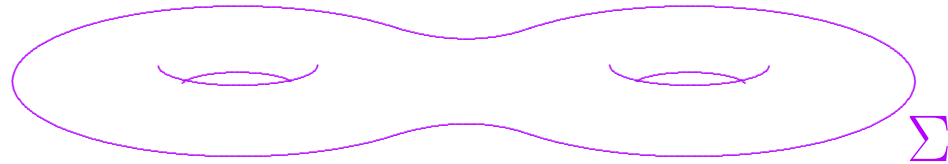

Scalar-flat Kähler deformations: $12(g-1)$ moduli
almost-Kähler ASD deformations: $30(g-1)$ moduli

Last result indicates that almost-Kähler condition gives extra control on ASD conformal geometry.

Inyoung Kim '16: classification of almost-Kähler ASD roughly the same as in scalar-flat Kähler case.

Does this say anything about general ASD metrics?

Almost-Kähler ASD metrics sweep out an open set in the ASD moduli space.

Last result indicates that almost-Kähler condition gives extra control on ASD conformal geometry.

Inyoung Kim '16: classification of almost-Kähler ASD roughly the same as in scalar-flat Kähler case.

Does this say anything about general ASD metrics?

Almost-Kähler ASD metrics sweep out an open set in the ASD moduli space.

Is this subset also closed?

Last result indicates that almost-Kähler condition gives extra control on ASD conformal geometry.

Inyoung Kim '16: classification of almost-Kähler ASD roughly the same as in scalar-flat Kähler case.

Does this say anything about general ASD metrics?

Almost-Kähler ASD metrics sweep out an open set in the ASD moduli space.

Is this subset also closed?

Does one get entire connected components this way?

Last result indicates that almost-Kähler condition gives extra control on ASD conformal geometry.

Inyoung Kim '16: classification of almost-Kähler ASD roughly the same as in scalar-flat Kähler case.

Does this say anything about general ASD metrics?

Almost-Kähler ASD metrics sweep out an open set in the ASD moduli space.

Is this subset also closed?

Does one get entire connected components this way?

Alas, **No!**

Theorem A.

Theorem A. Consider 4-manifold $M = \Sigma \times S^2$,

Theorem A. Consider 4-manifold $M = \Sigma \times S^2$,
where Σ compact Riemann surface of genus g .

Theorem A. Consider 4-manifolds $M = \Sigma \times S^2$,
where Σ compact Riemann surface of genus g .

Theorem A. Consider 4-manifolds $M = \Sigma \times S^2$,
where Σ compact Riemann surface of genus g .

Then $\forall \quad g \gg 0$,

Theorem A. Consider 4-manifolds $M = \Sigma \times S^2$,
where Σ compact Riemann surface of genus g .

Then \forall even $g \gg 0$,

Theorem A. Consider 4-manifolds $M = \Sigma \times S^2$,
where Σ compact Riemann surface of genus g .

Then \forall even $g \gg 0$, \exists family $[g_t]$,

Theorem A. Consider 4-manifolds $M = \Sigma \times S^2$,
where Σ compact Riemann surface of genus g .

Then \forall even $g \gg 0$, \exists family $[g_t]$, $t \in [0, 1]$,

Theorem A. Consider 4-manifolds $M = \Sigma \times S^2$, where Σ compact Riemann surface of genus g .

Then \forall even $g \gg 0$, \exists family $[g_t]$, $t \in [0, 1]$, of locally-conformally-flat classes on M ,

Theorem A. Consider 4-manifolds $M = \Sigma \times S^2$, where Σ compact Riemann surface of genus g .

Then \forall even $g \gg 0$, \exists family $[g_t]$, $t \in [0, 1]$, of locally-conformally-flat classes on M , such that

Theorem A. Consider 4-manifolds $M = \Sigma \times S^2$, where Σ compact Riemann surface of genus g .

Then \forall even $g \gg 0$, \exists family $[g_t]$, $t \in [0, 1]$, of locally-conformally-flat classes on M , such that

- \exists scalar-flat Kähler metric $g_0 \in [g_0]$; but

Theorem A. Consider 4-manifolds $M = \Sigma \times S^2$, where Σ compact Riemann surface of genus g .

Then \forall even $g \gg 0$, \exists family $[g_t]$, $t \in [0, 1]$, of locally-conformally-flat classes on M , such that

- \exists scalar-flat Kähler metric $g_0 \in [g_0]$; but
- \nexists almost-Kähler metric $g \in [g_1]$.

Theorem A. Consider 4-manifolds $M = \Sigma \times S^2$, where Σ compact Riemann surface of genus g .

Then \forall even $g \gg 0$, \exists family $[g_t]$, $t \in [0, 1]$, of locally-conformally-flat classes on M , such that

- \exists scalar-flat Kähler metric $g_0 \in [g_0]$; but
- \nexists almost-Kähler metric $g \in [g_1]$.

Same method simultaneously proves...

Theorem B.

Theorem B. *Fix an integer $k \geq 2$,*

Theorem B. Fix an integer $k \geq 2$, and then consider the 4-manifolds $M = (\Sigma \times S^2) \#^k \overline{\mathbb{C}P}_2$,

Theorem B. *Fix an integer $k \geq 2$, and then consider the 4-manifolds $M = (\Sigma \times S^2) \#^k \overline{\mathbb{C}P}_2$, where Σ compact Riemann surface of genus g .*

Theorem B. Fix an integer $k \geq 2$, and then consider the 4-manifolds $M = (\Sigma \times S^2) \#^k \overline{\mathbb{C}P}_2$, where Σ compact Riemann surface of genus g .

Then \forall even $g \gg 0$, \exists family $[g_t]$, $t \in [0, 1]$,

Theorem B. Fix an integer $k \geq 2$, and then consider the 4-manifolds $M = (\Sigma \times S^2) \#^k \overline{\mathbb{C}\mathbb{P}}_2$, where Σ compact Riemann surface of genus g .

Then \forall even $g \gg 0$, \exists family $[g_t]$, $t \in [0, 1]$, of anti-self-dual conformal classes on M ,

Theorem B. Fix an integer $k \geq 2$, and then consider the 4-manifolds $M = (\Sigma \times S^2) \#^k \overline{\mathbb{C}\mathbb{P}}_2$, where Σ compact Riemann surface of genus g .

Then \forall even $g \gg 0$, \exists family $[g_t]$, $t \in [0, 1]$, of anti-self-dual conformal classes on M , such that

- \exists scalar-flat Kähler metric $g_0 \in [g_0]$; but

Theorem B. Fix an integer $k \geq 2$, and then consider the 4-manifolds $M = (\Sigma \times S^2) \#^k \overline{\mathbb{C}\mathbb{P}}_2$, where Σ compact Riemann surface of genus g .

Then \forall even $g \gg 0$, \exists family $[g_t]$, $t \in [0, 1]$, of anti-self-dual conformal classes on M , such that

- \exists scalar-flat Kähler metric $g_0 \in [g_0]$; but
- \nexists almost-Kähler metric $g \in [g_1]$.

Theorem B. Fix an integer $k \geq 2$, and then consider the 4-manifolds $M = (\Sigma \times S^2) \#^k \overline{\mathbb{C}\mathbb{P}}_2$, where Σ compact Riemann surface of genus g .

Then \forall even $g \gg 0$, \exists family $[g_t]$, $t \in [0, 1]$, of anti-self-dual conformal classes on M , such that

- \exists scalar-flat Kähler metric $g_0 \in [g_0]$; but
- \nexists almost-Kähler metric $g \in [g_1]$.

Proof hinges on a construction of hyperbolic 3-manifolds.

Theorem B. Fix an integer $k \geq 2$, and then consider the 4-manifolds $M = (\Sigma \times S^2) \#^k \overline{\mathbb{C}\mathbb{P}}_2$, where Σ compact Riemann surface of genus g .

Then \forall even $g \gg 0$, \exists family $[g_t]$, $t \in [0, 1]$, of anti-self-dual conformal classes on M , such that

- \exists scalar-flat Kähler metric $g_0 \in [g_0]$; but
- \nexists almost-Kähler metric $g \in [g_1]$.

Proof hinges on a construction of hyperbolic 3-manifolds.

We begin by revisiting hyperbolic metrics on Σ .

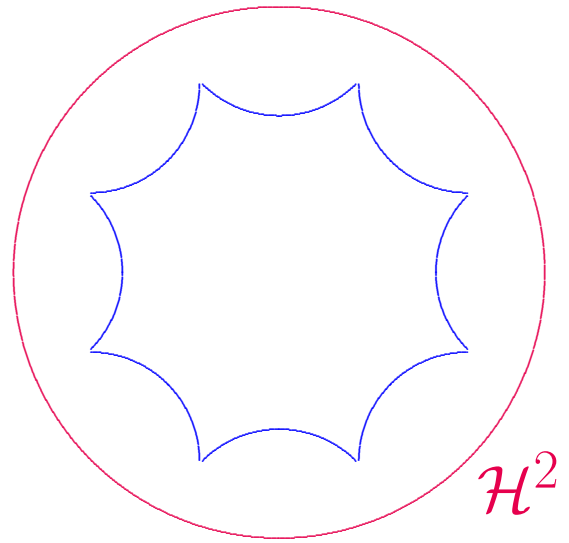

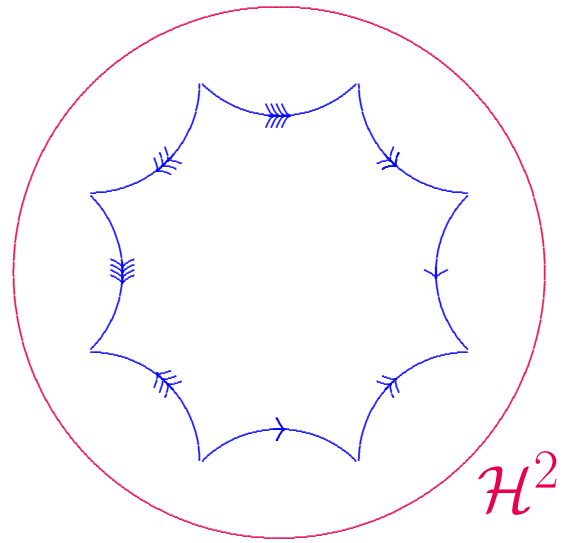

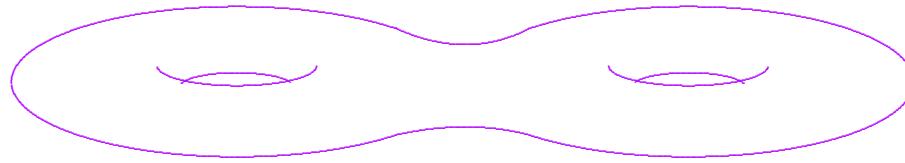
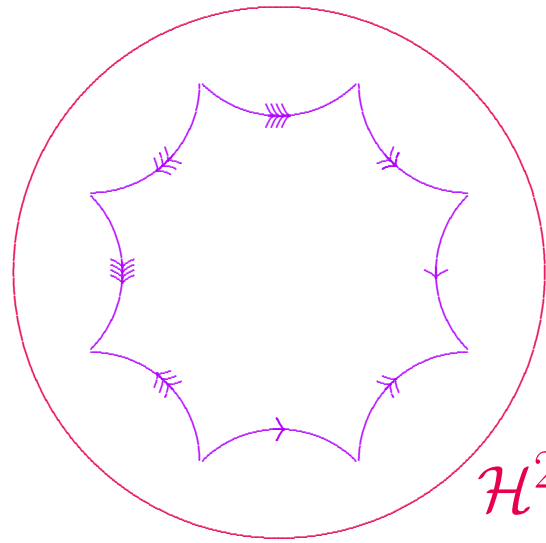

\mathcal{H}^2

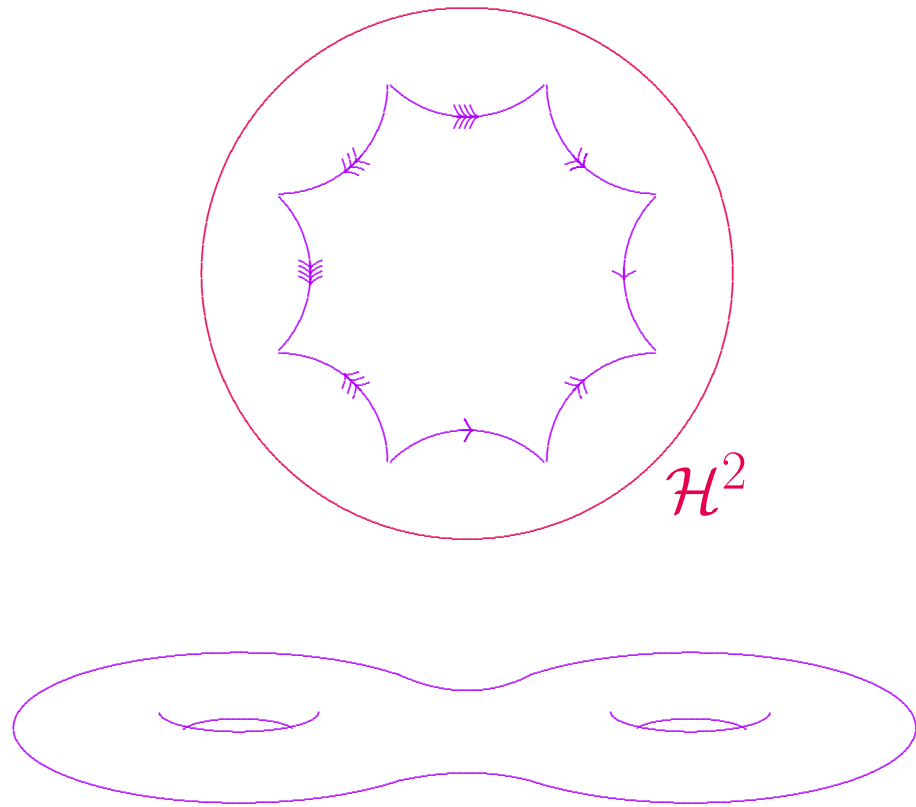

$$\pi_1(\Sigma) \hookrightarrow \mathbf{SO}_+(1, 2) = \mathbf{PSL}(2, \mathbb{R})$$

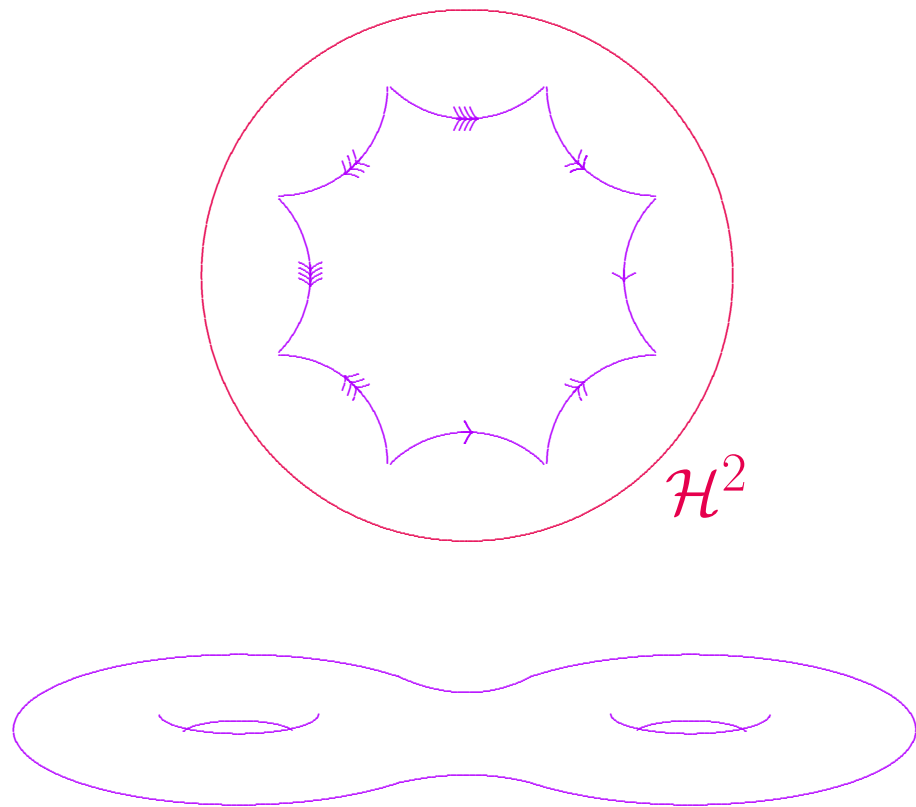

$$\begin{array}{ccc}
 \pi_1(\Sigma) & \hookrightarrow & \mathbf{SO}_+(1, 2) = \mathbf{PSL}(2, \mathbb{R}) \\
 & & \cap \qquad \qquad \cap \\
 & & \mathbf{SO}_+(1, 3) = \mathbf{PSL}(2, \mathbb{C})
 \end{array}$$

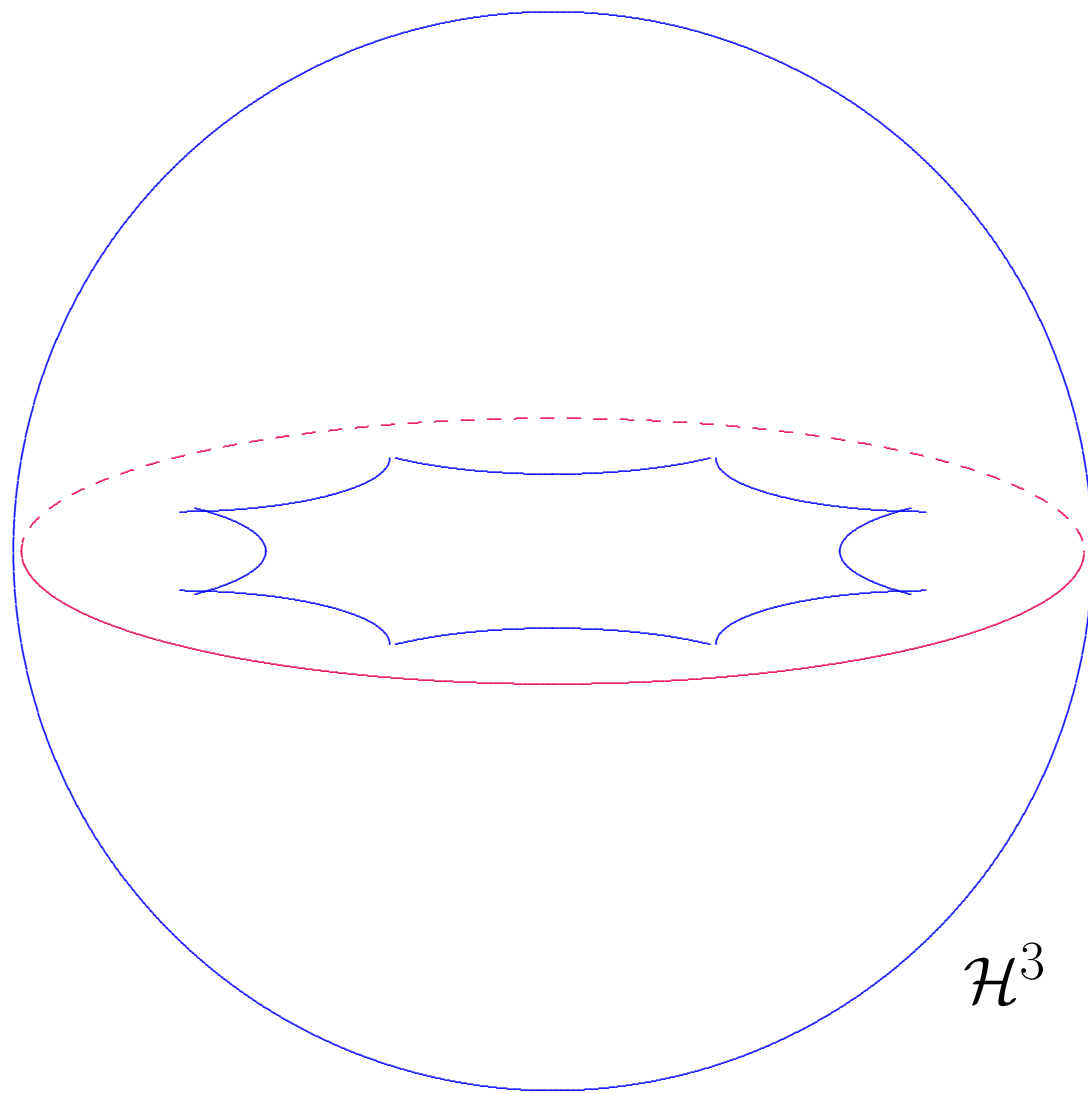

\mathcal{H}^3

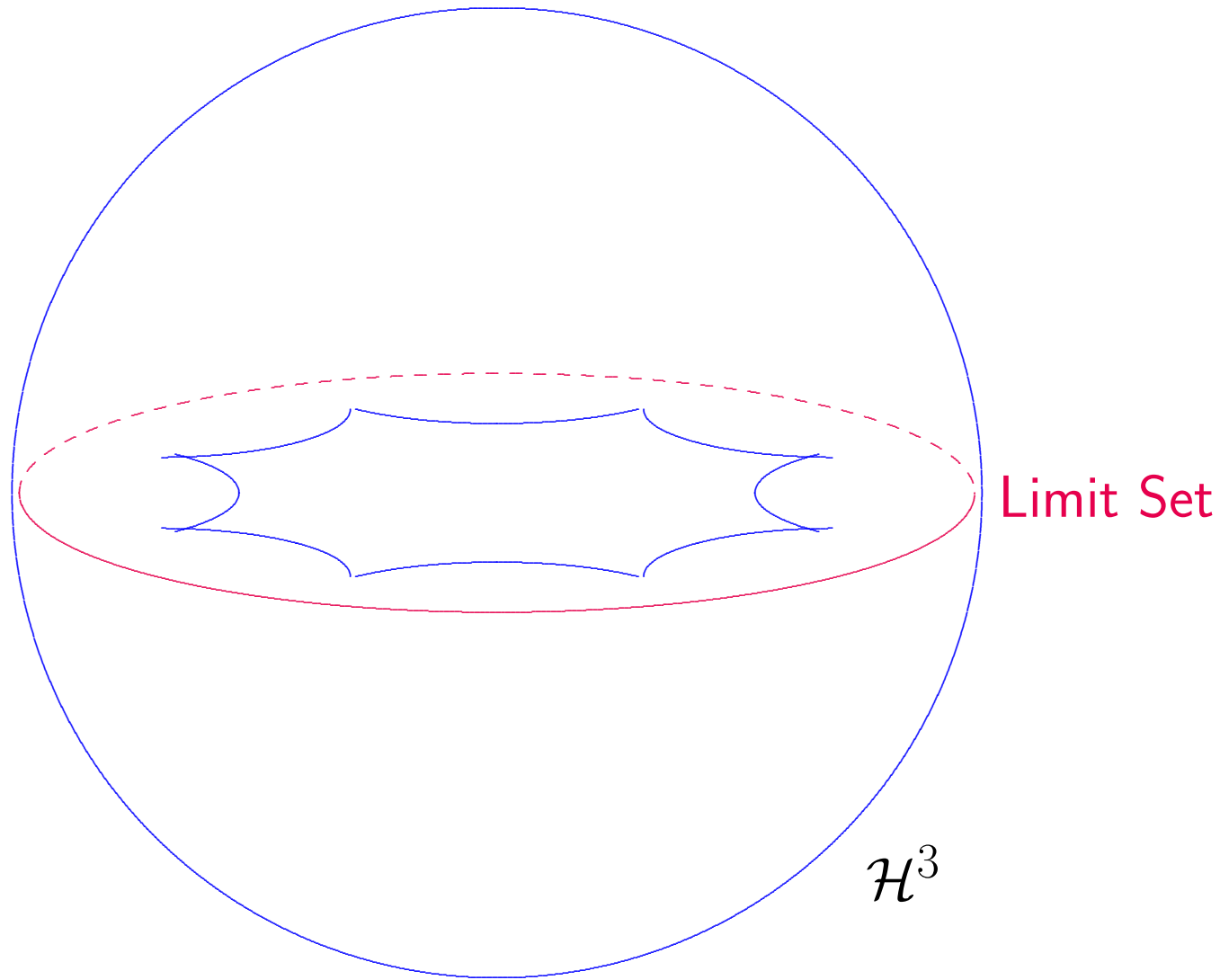

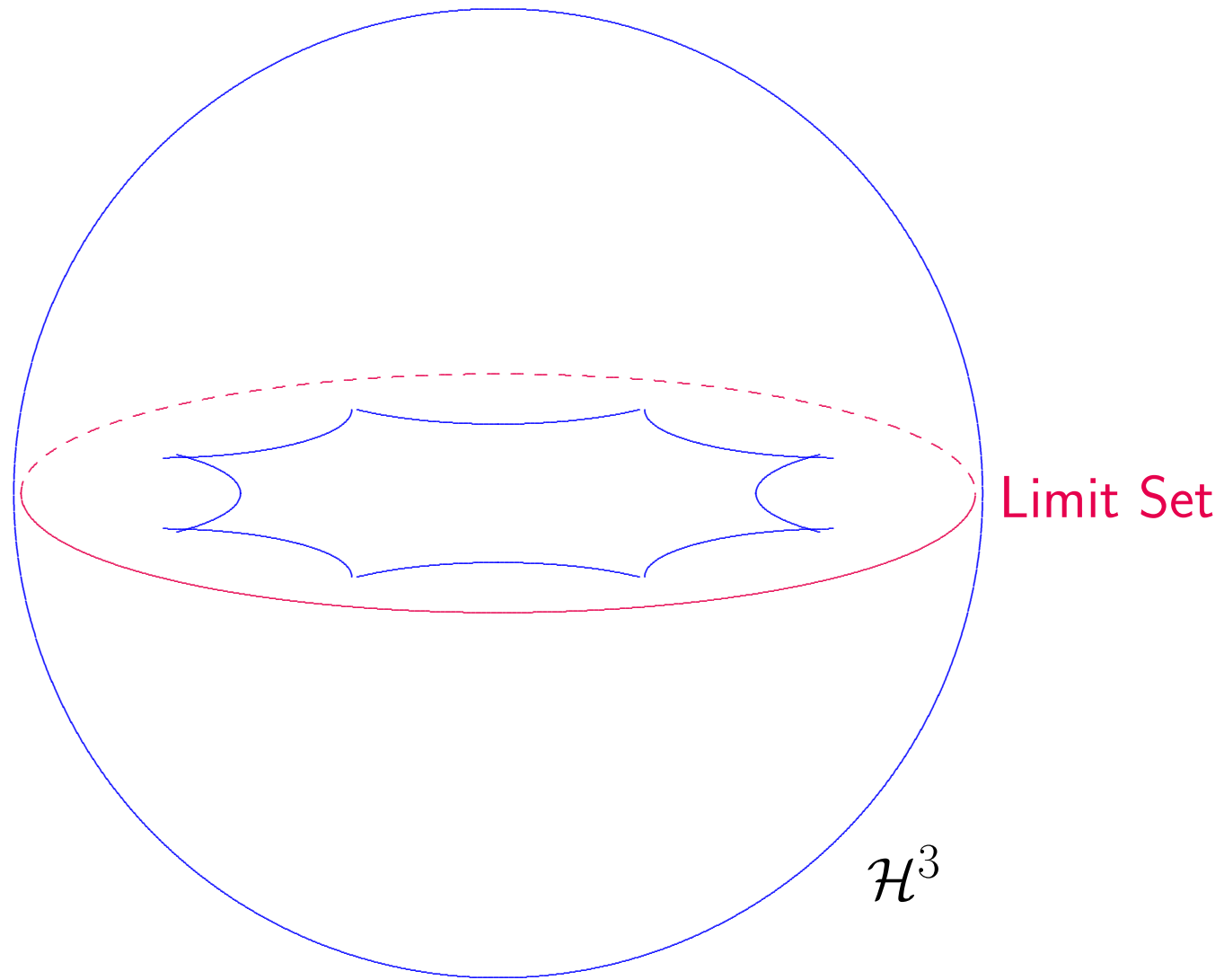

$$\pi_1(\Sigma) \xrightarrow{\cong} \Gamma \subset \mathbf{PSL}(2, \mathbb{R}) \text{ Fuchsian group}$$

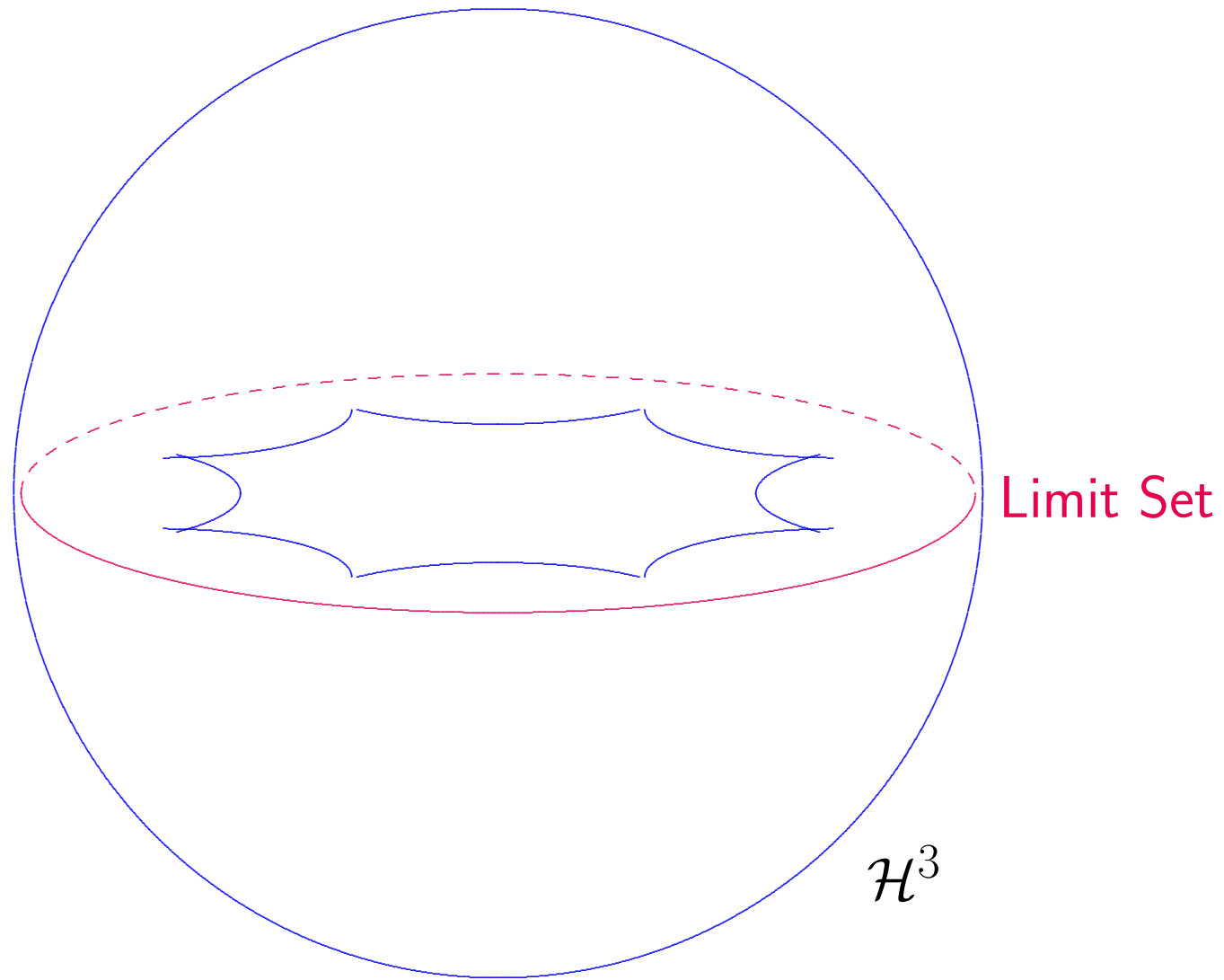

$$\pi_1(\Sigma) \xrightarrow{\cong} \Gamma \subset \mathbf{PSL}(2, \mathbb{C}) \text{ Fuchsian group}$$

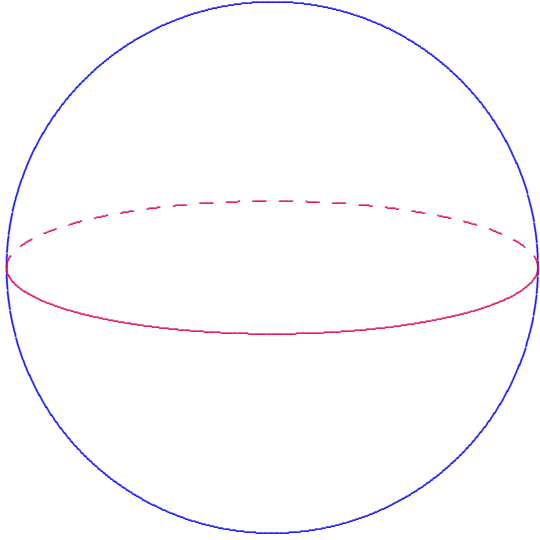

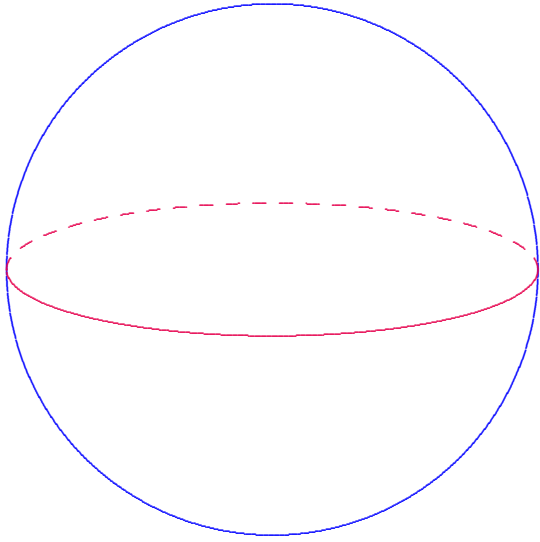

Fuchsian

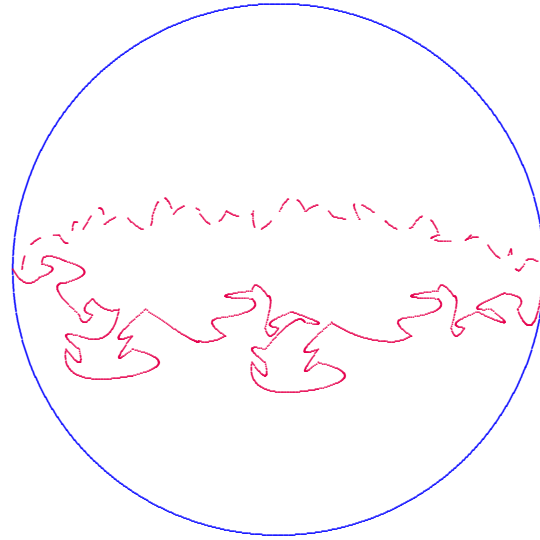
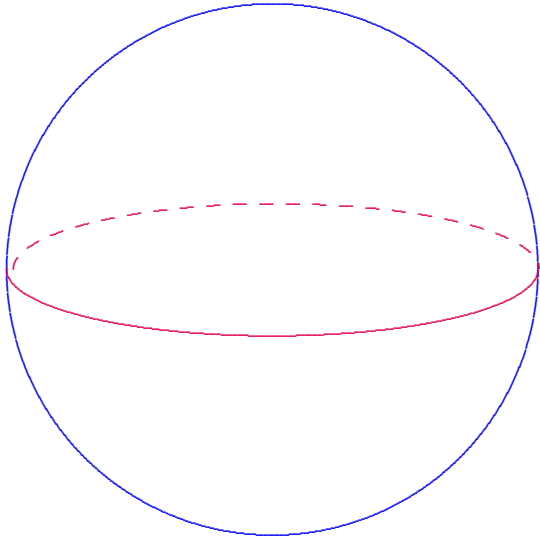

Fuchsian

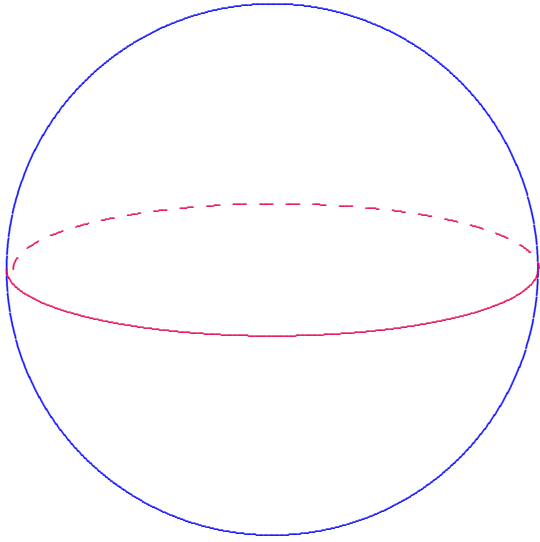

Fuchsian

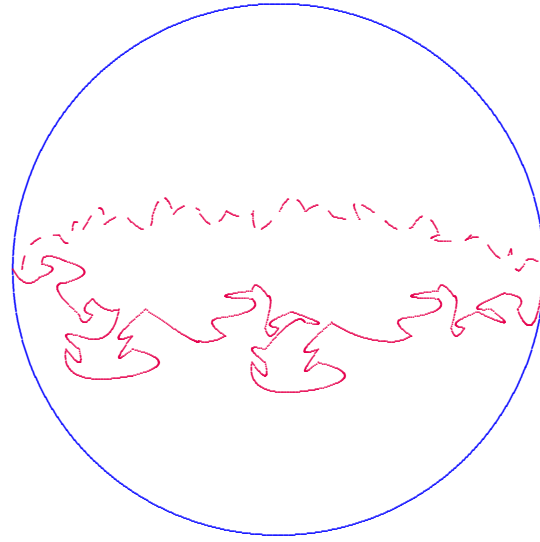

quasi-Fuchsian

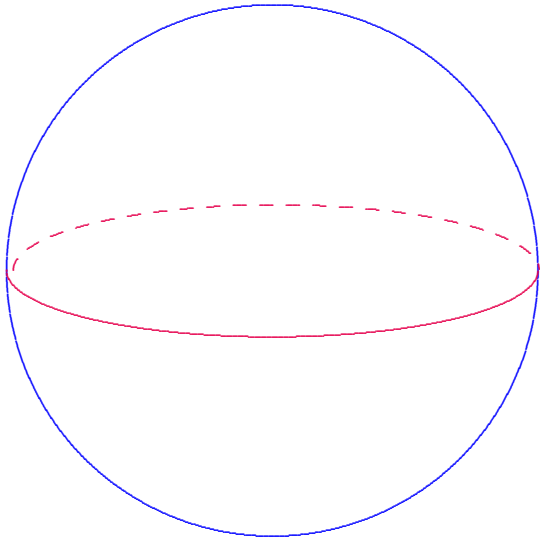

Fuchsian

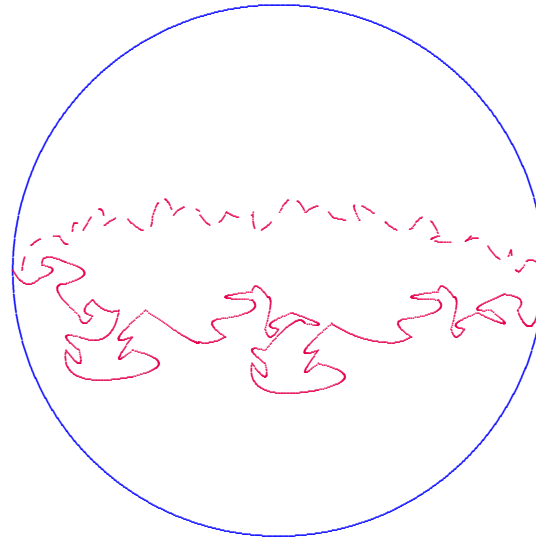

quasi-Fuchsian

$$\pi_1(\Sigma) \xrightarrow{\cong} \Gamma \subset \mathbf{PSL}(2, \mathbb{C}) \text{ quasi-Fuchsian group}$$

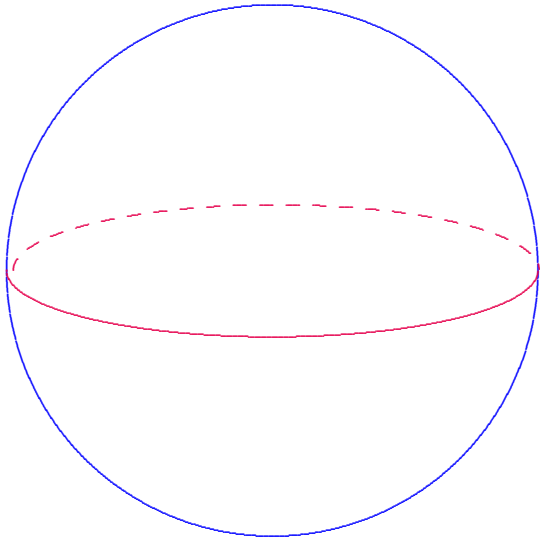

Fuchsian

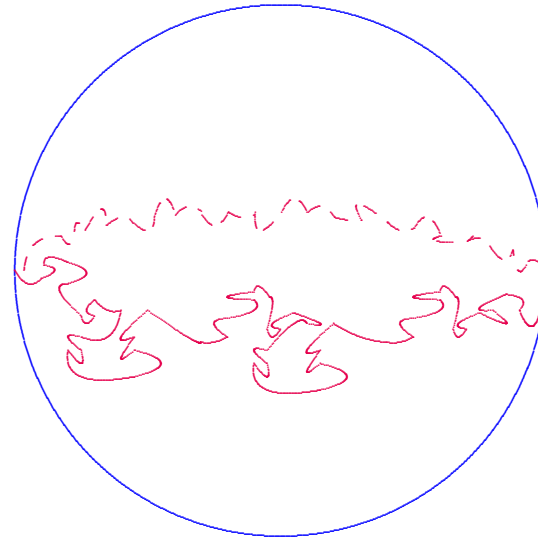

quasi-Fuchsian

$$\pi_1(\Sigma) \xrightarrow{\cong} \Gamma \subset \mathbf{PSL}(2, \mathbb{C}) \text{ quasi-Fuchsian group of Bers type}$$

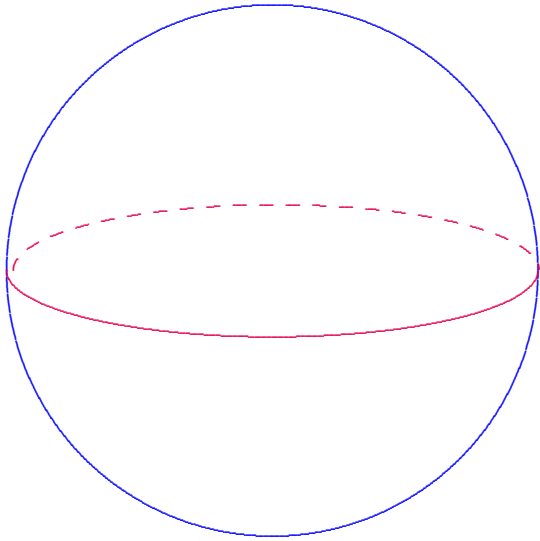

Fuchsian

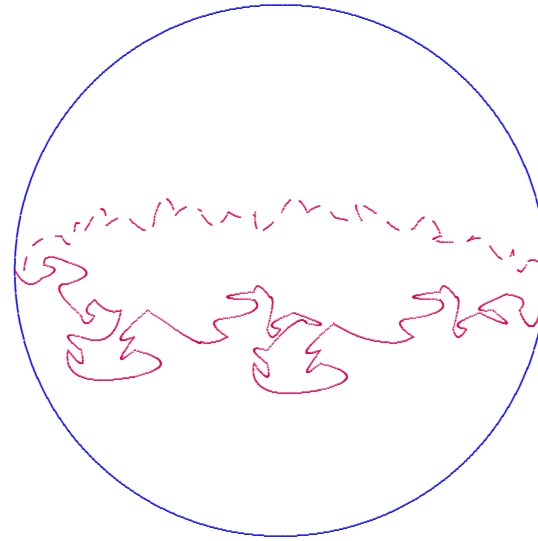

quasi-Fuchsian

$$\pi_1(\Sigma) \xrightarrow{\cong} \Gamma \subset \mathbf{PSL}(2, \mathbb{C}) \text{ quasi-Fuchsian group of Bers type}$$

Quasi-conformally conjugate to Fuchsian.

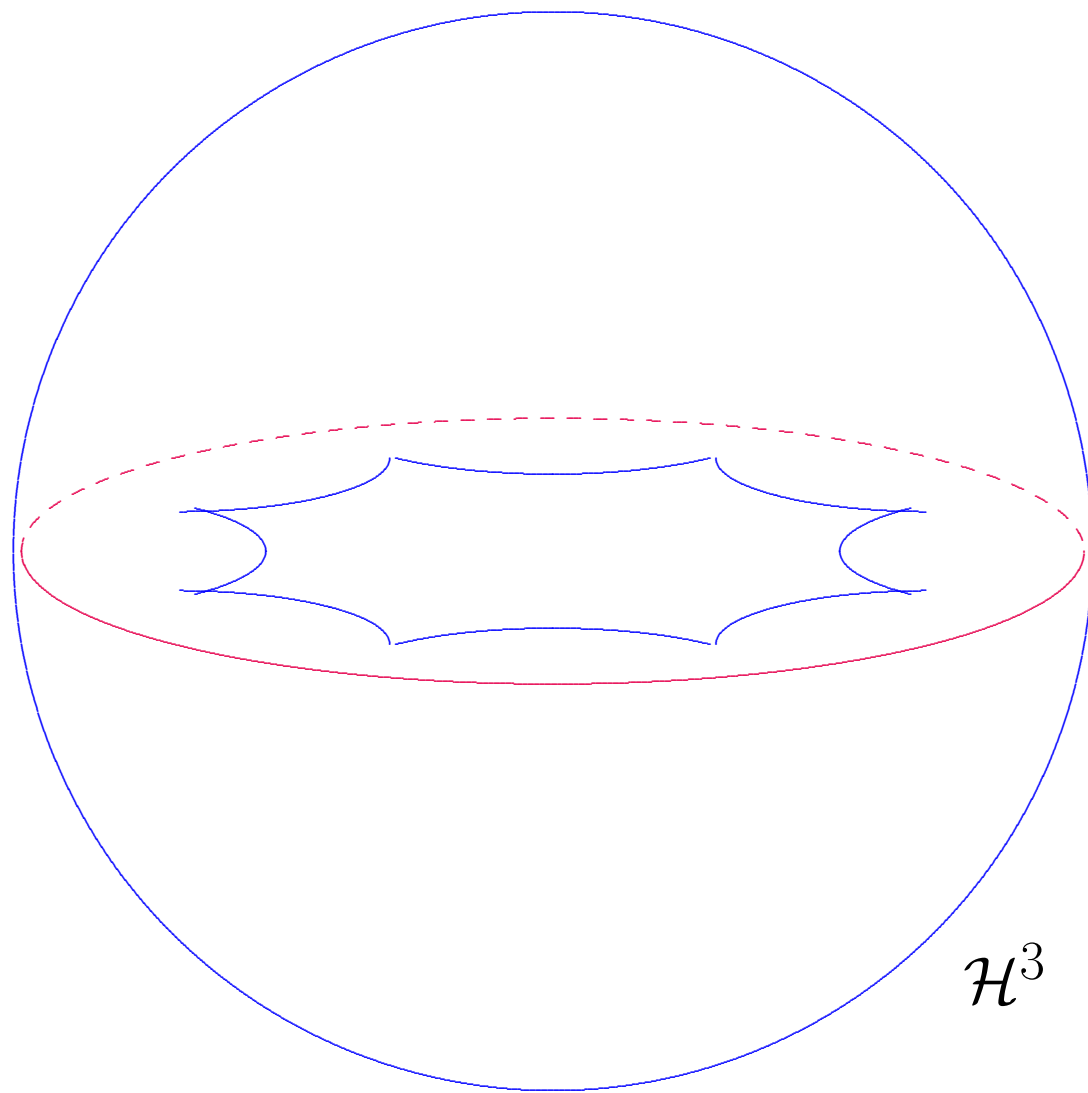

\mathcal{H}^3

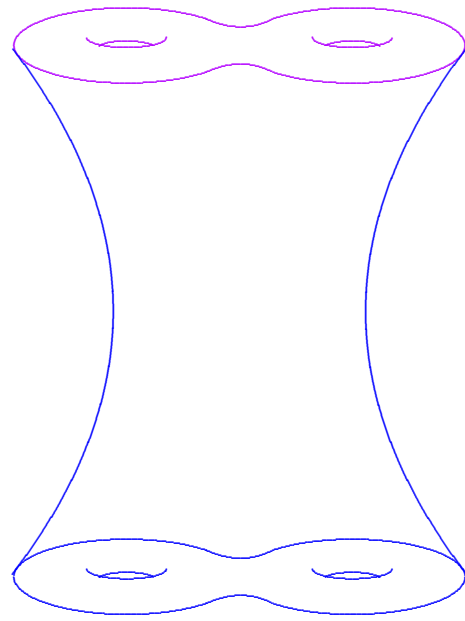

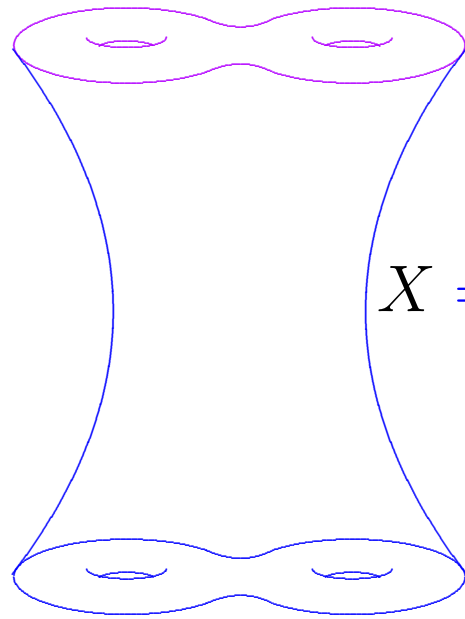

$$X = \mathcal{H}^3 / \Gamma$$

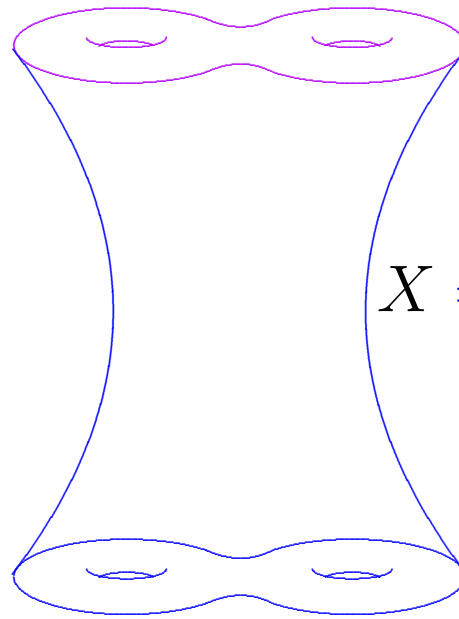

$$X = \mathcal{H}^3 / \Gamma$$

Γ Fuchsian

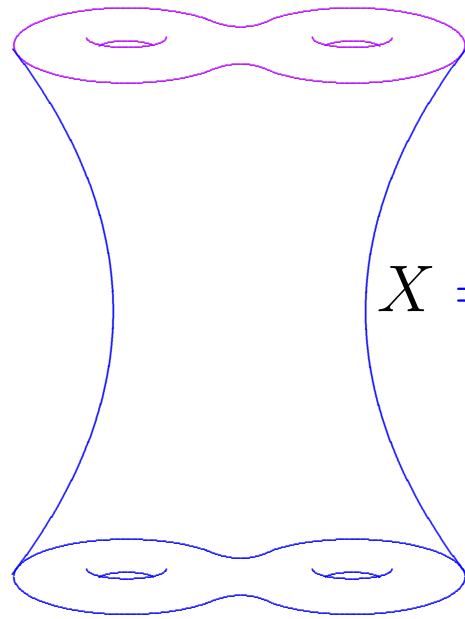

$$X = \mathcal{H}^3 / \Gamma$$

Γ Fuchsian

$$X \approx \Sigma \times \mathbb{R}$$

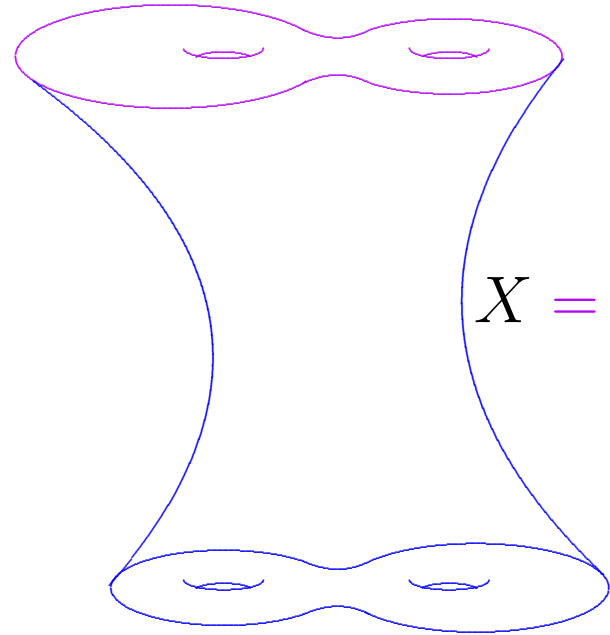

$$X = \mathcal{H}^3 / \Gamma$$

Γ quasi-Fuchsian

$$X \approx \Sigma \times \mathbb{R}$$

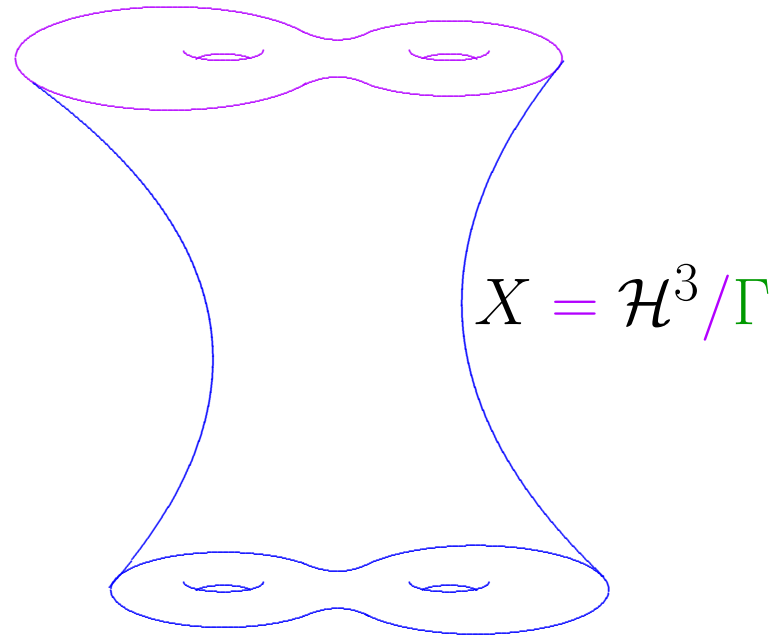

Γ quasi-Fuchsian

$$X \approx \Sigma \times \mathbb{R}$$

Freedom: two points in Teichmüller space.

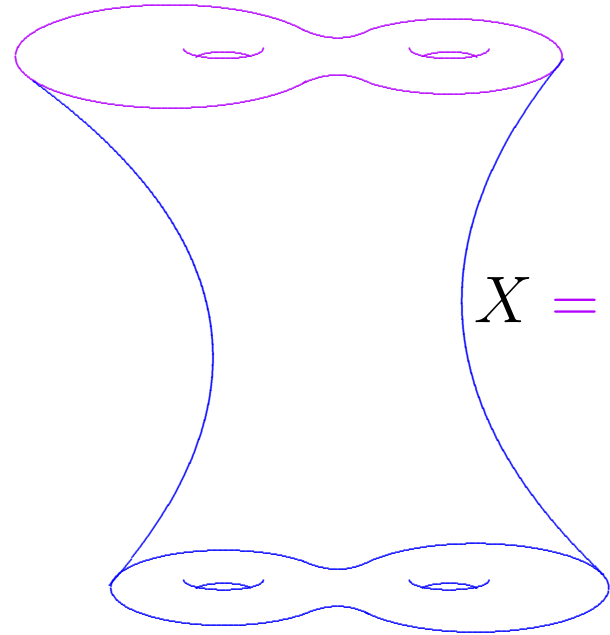

$$X = \mathcal{H}^3 / \Gamma$$

Γ quasi-Fuchsian

$$X \approx \Sigma \times \mathbb{R}$$

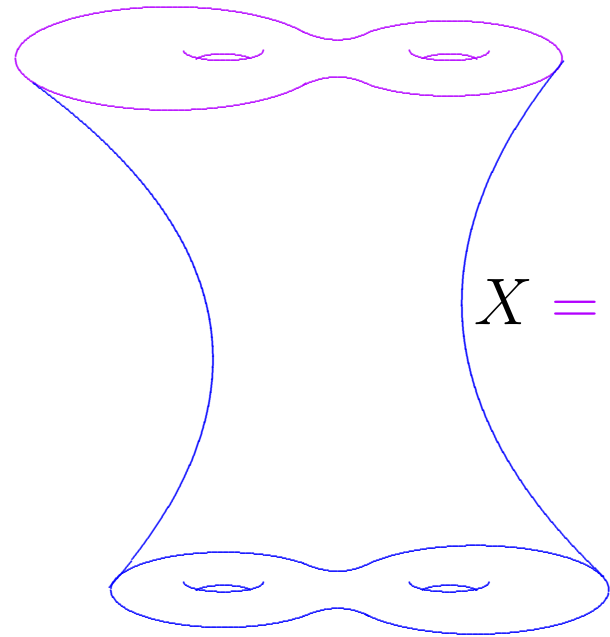

$$X = \mathcal{H}^3 / \Gamma$$

Γ quasi-Fuchsian

$$\overline{X} \approx \Sigma \times [0, 1]$$

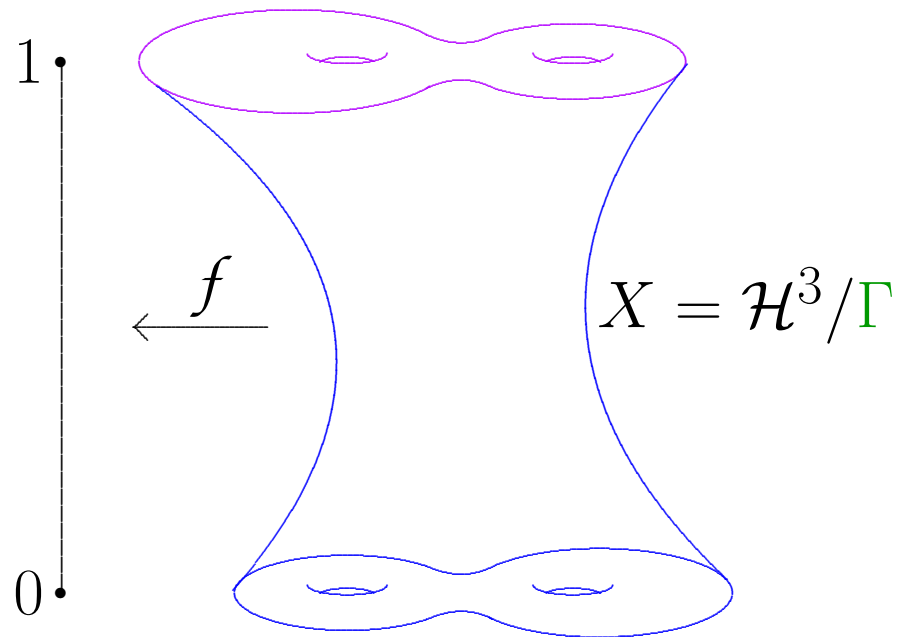

Γ quasi-Fuchsian

$$\overline{X} \approx \Sigma \times [0, 1]$$

Tunnel-Vision function:

$$f : \overline{X} \rightarrow [0, 1]$$

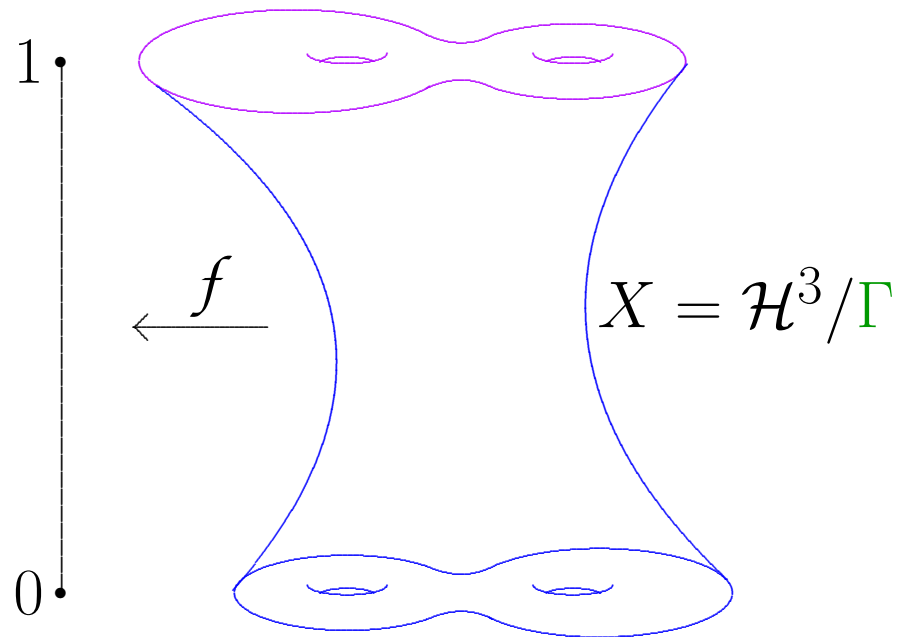

Γ quasi-Fuchsian

$$\bar{X} \approx \Sigma \times [0, 1]$$

Tunnel-Vision function:

$$f : \bar{X} \rightarrow [0, 1]$$

$$\Delta f = 0$$

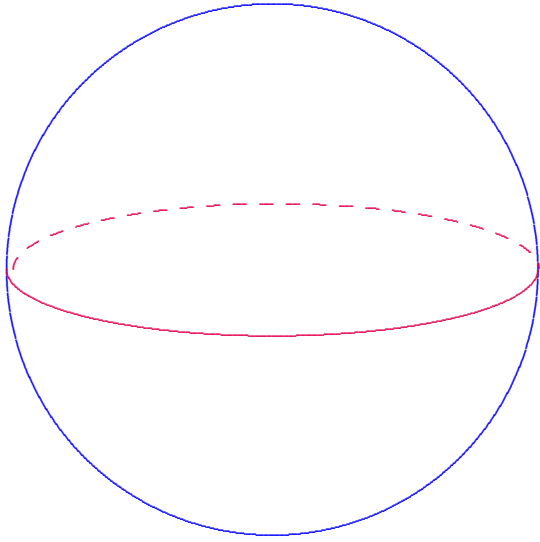

Fuchsian

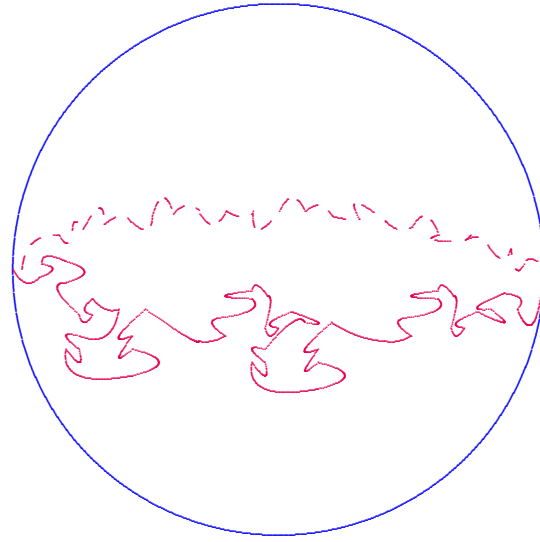

quasi-Fuchsian

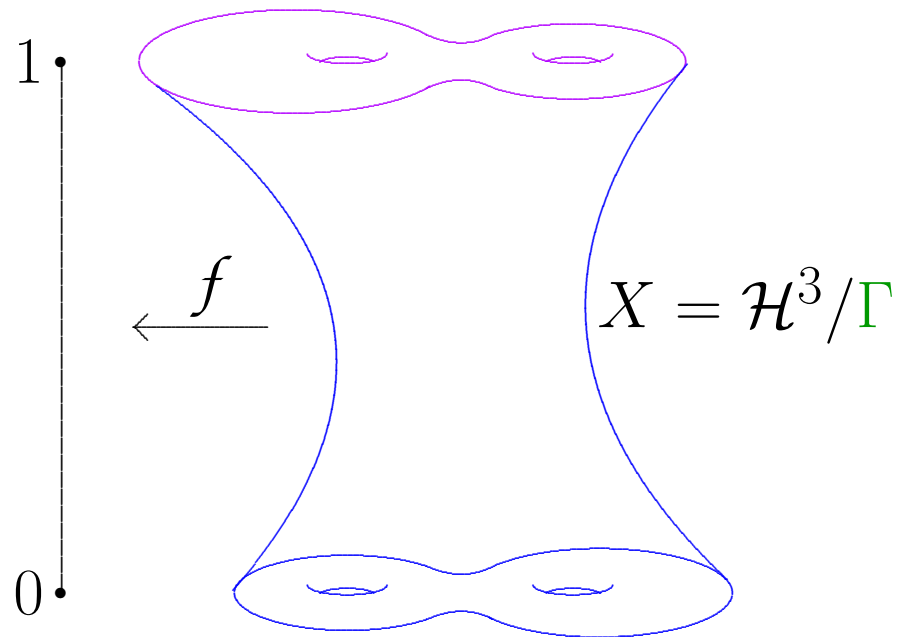

Γ quasi-Fuchsian

$$\overline{X} \approx \Sigma \times [0, 1]$$

Tunnel-Vision function:

$$f : \overline{X} \rightarrow [0, 1]$$

$$\Delta f = 0$$

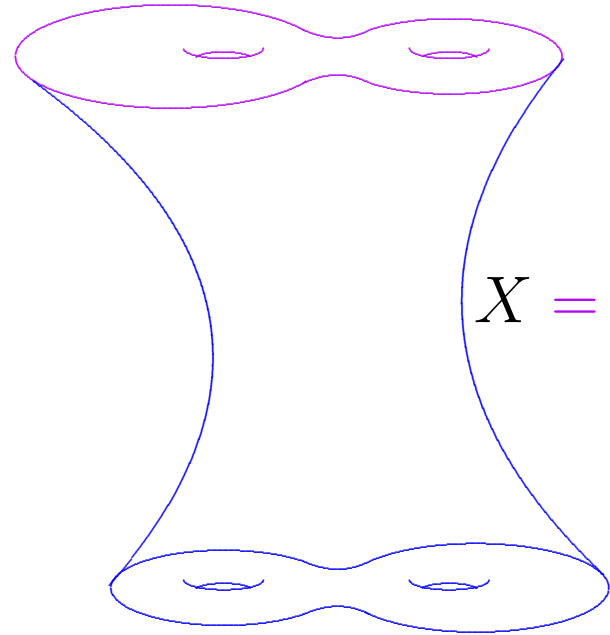

$$X = \mathcal{H}^3 / \Gamma$$

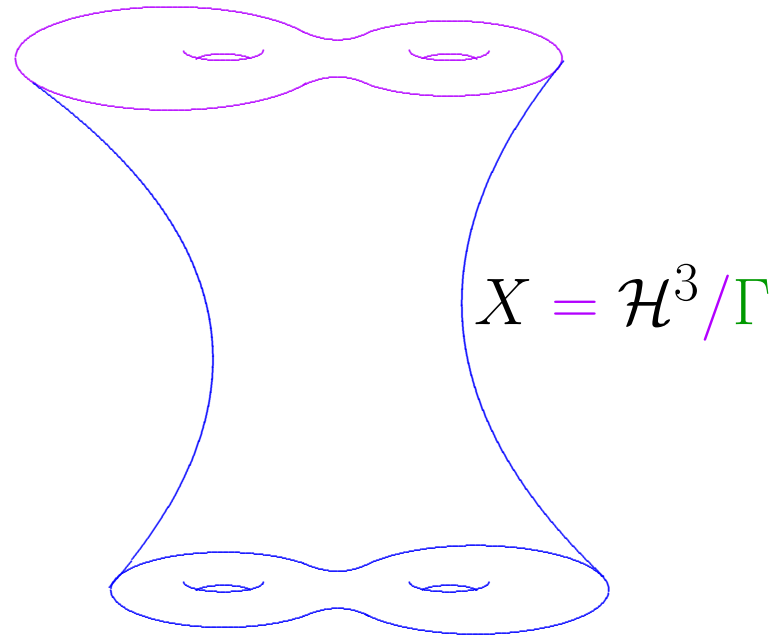

Construction of conformally flat 4-manifolds:

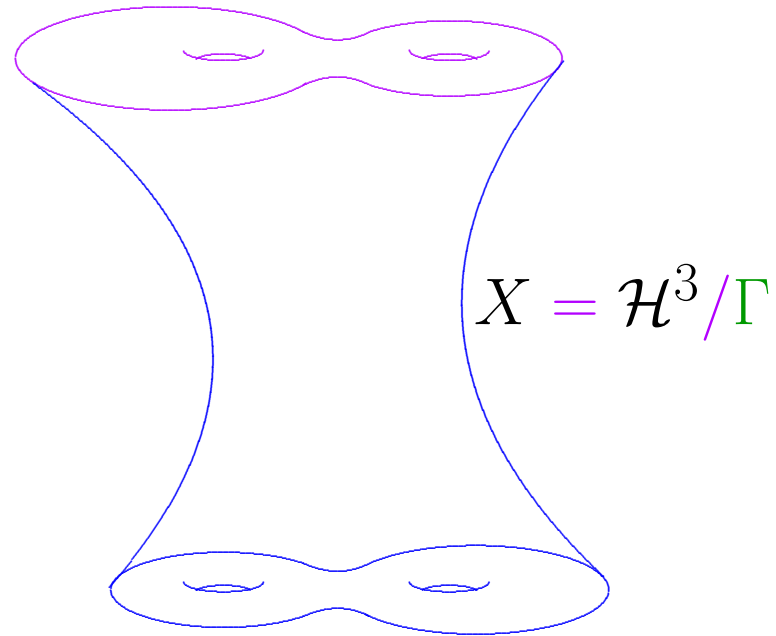

Construction of conformally flat 4-manifolds:

$$M = [\bar{X} \times S^1] / \sim$$

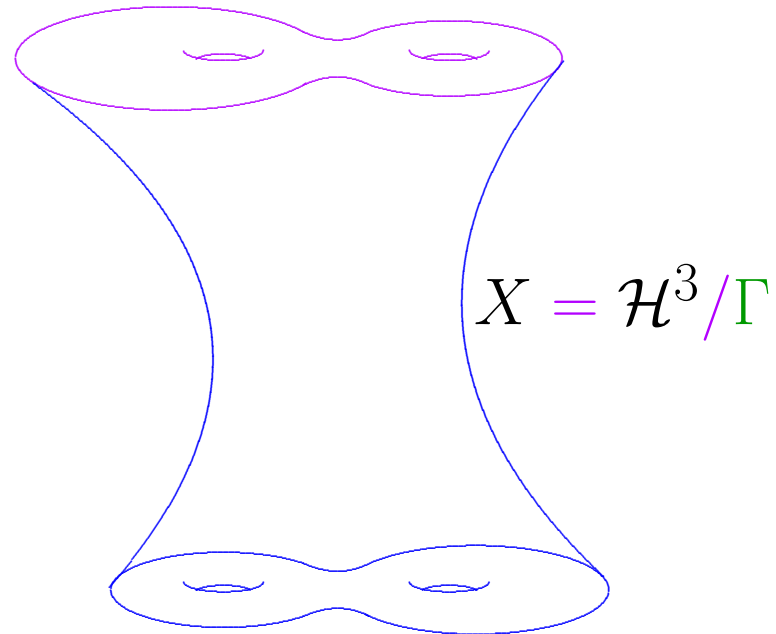

Construction of conformally flat 4-manifolds:

$$M = [\bar{X} \times S^1] / \sim$$

\sim : crush $\partial\bar{X} \times S^1$ to $\partial\bar{X}$.

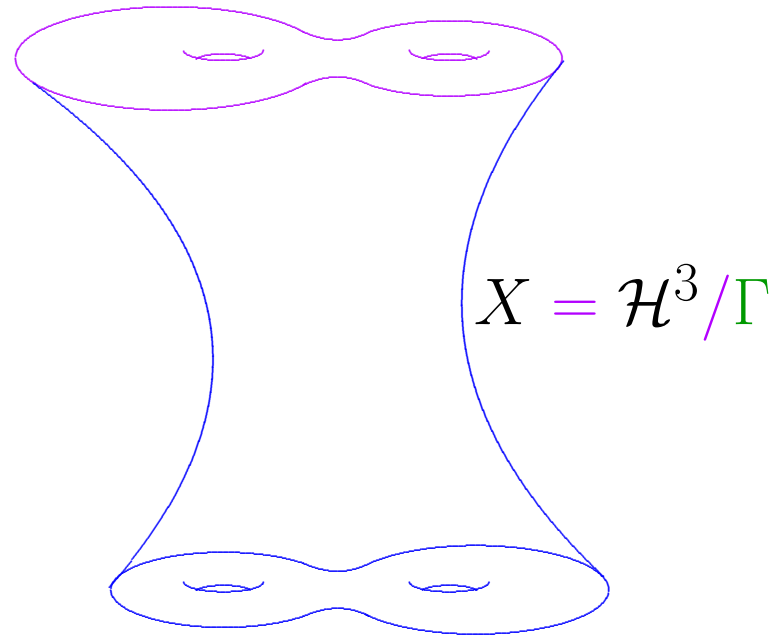

Construction of conformally flat 4-manifolds:

$$M = [\bar{X} \times S^1] / \sim$$

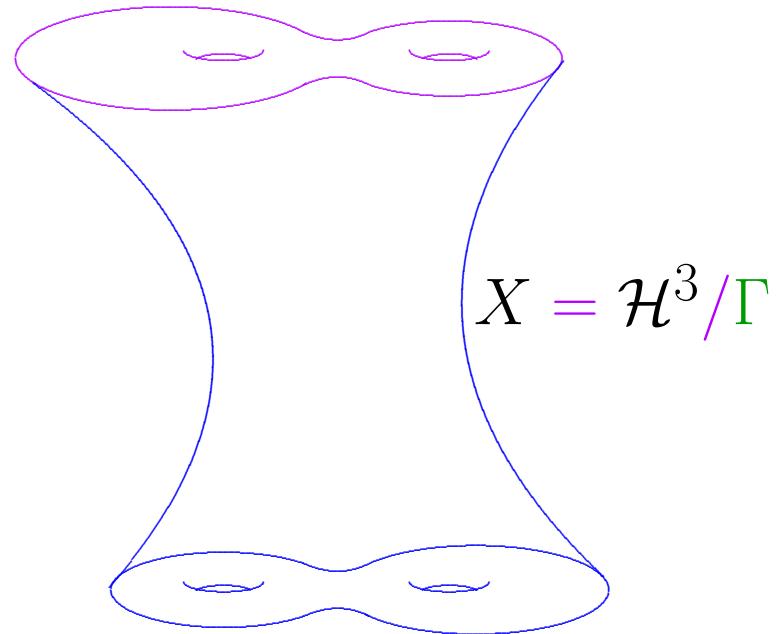

Construction of conformally flat 4-manifolds:

$$M = [\bar{X} \times S^1] / \sim$$

$$g = h + dt^2$$

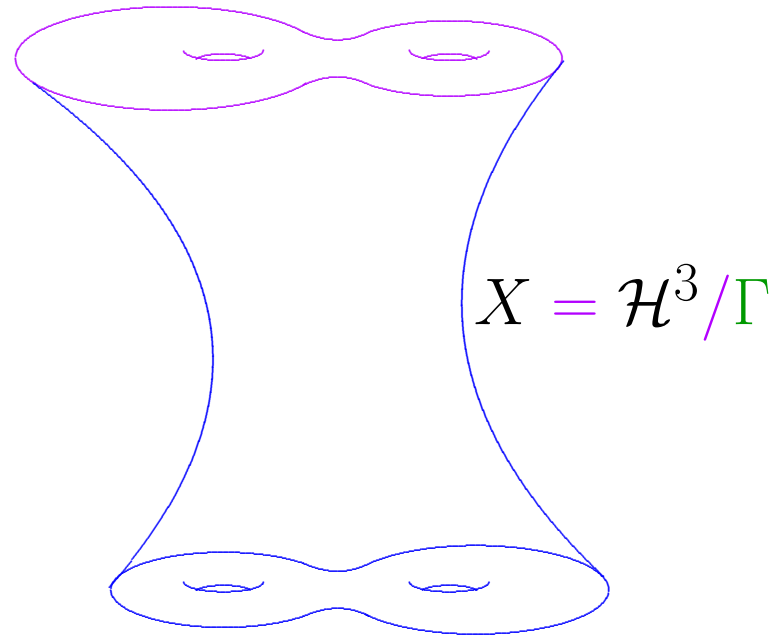

Construction of conformally flat 4-manifolds:

$$M = [\bar{X} \times S^1] / \sim$$

$$g = f(1 - f)[h + dt^2]$$

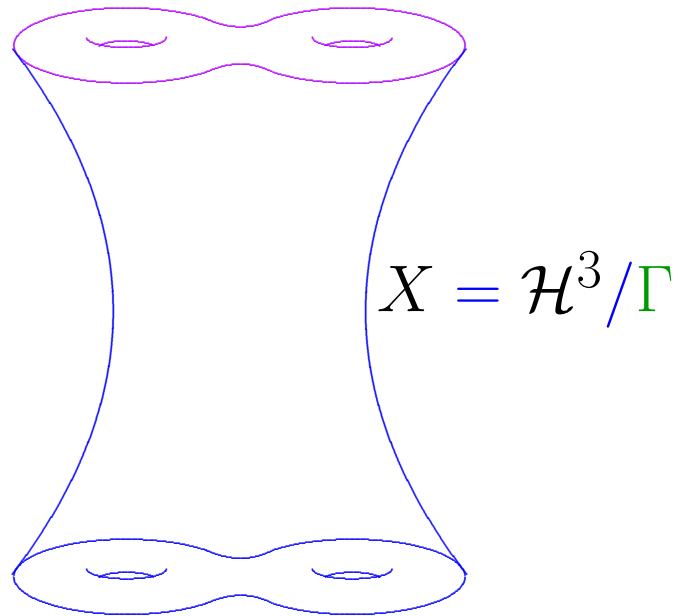

Construction of conformally flat 4-manifolds:

$$M = [\bar{X} \times S^1] / \sim$$

$$g = f(1 - f)[h + dt^2]$$

Fuchsian case: $\Sigma \times S^2$ scalar-flat Kähler.

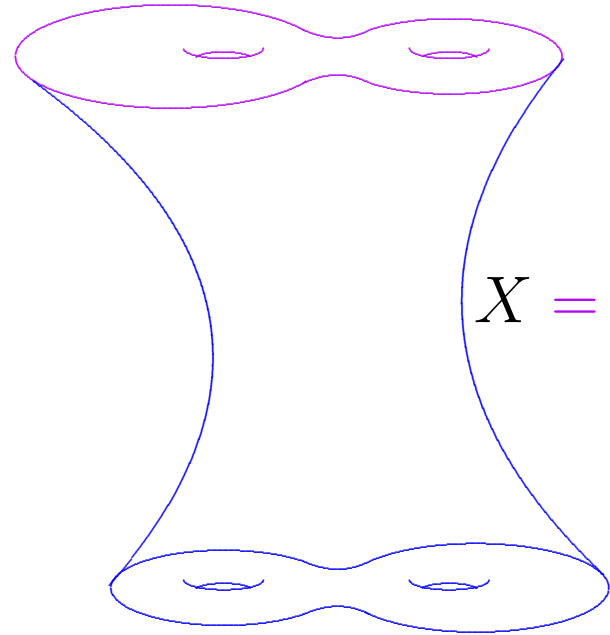

$$X = \mathcal{H}^3 / \Gamma$$

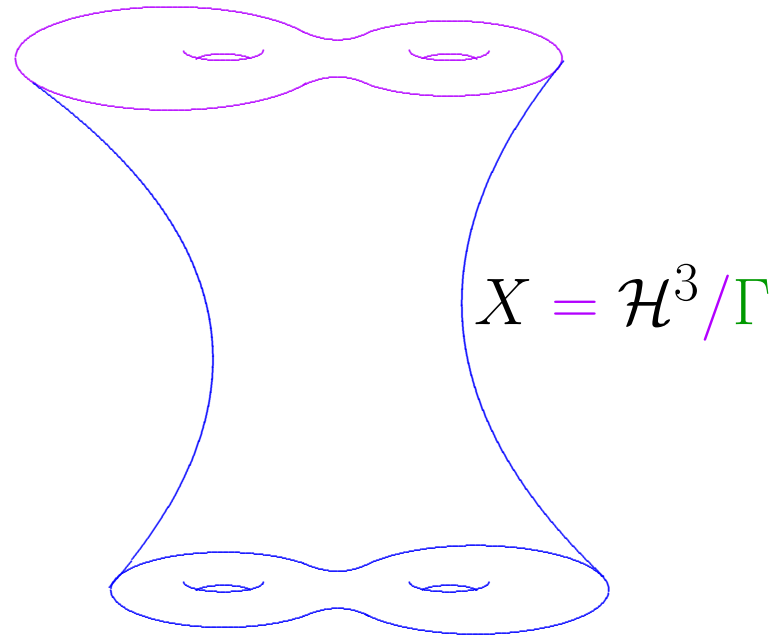

Construction of ASD 4-manifolds:

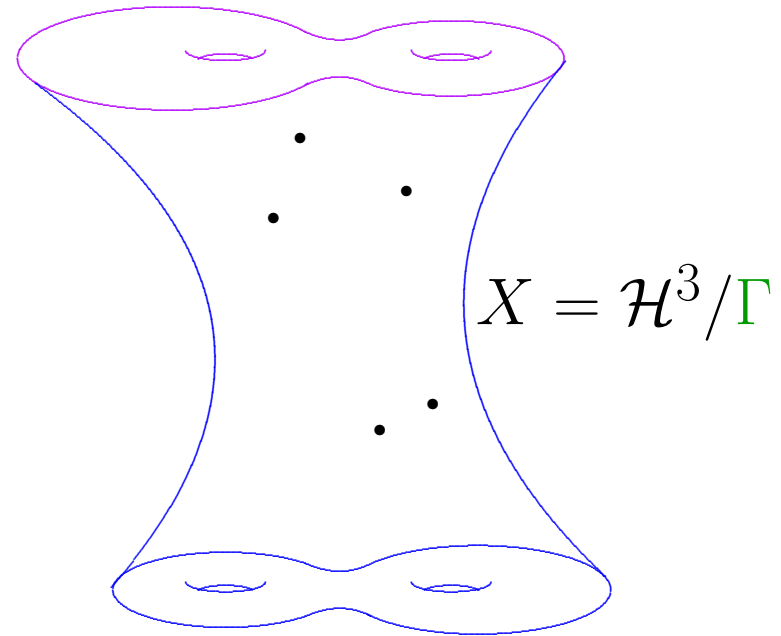

Construction of ASD 4-manifolds:

Choose k points $p_1, \dots, p_k \in X$

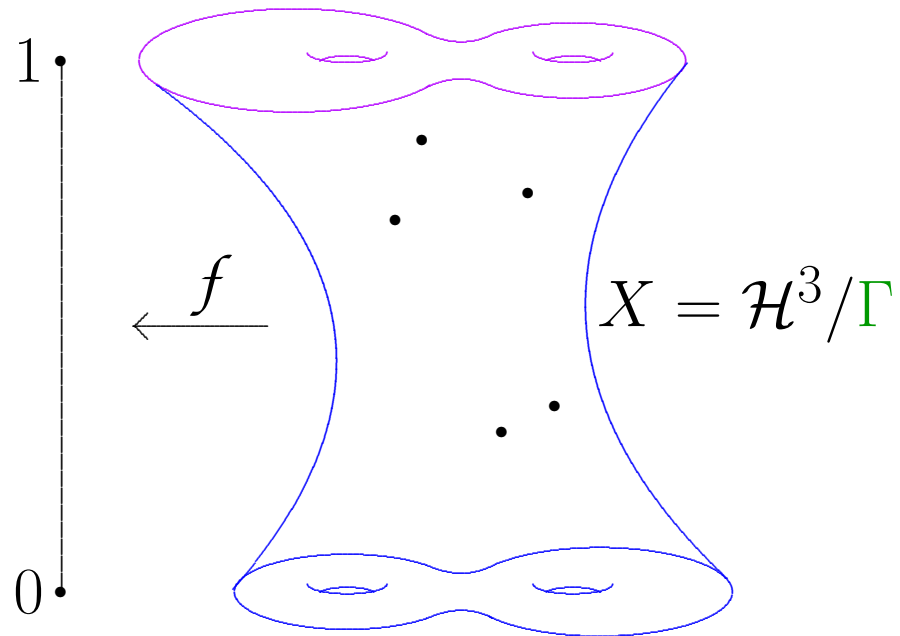

Construction of ASD 4-manifolds:

Choose k points $p_1, \dots, p_k \in X$

satisfying $\sum_{j=1}^k f(p_j) \in \mathbb{Z}$.

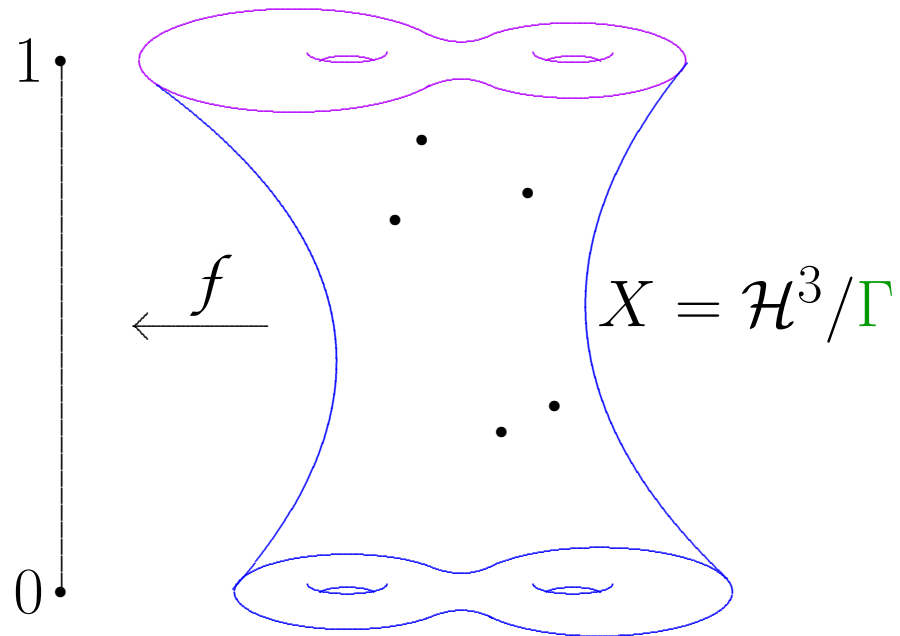

Construction of ASD 4-manifolds:

Choose k points $p_1, \dots, p_k \in X$

satisfying $\sum_{j=1}^k f(p_j) \in \mathbb{Z}$.

Can do if $k \neq 1$.

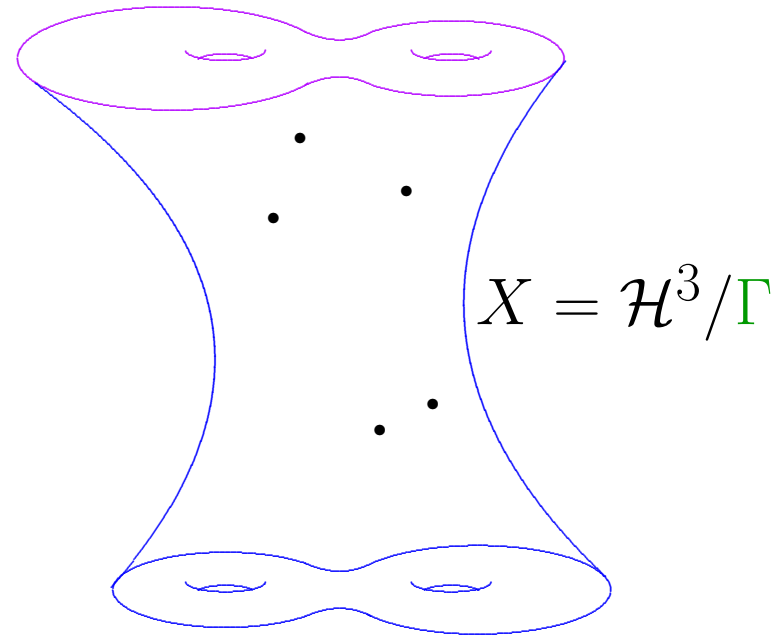

Construction of ASD 4-manifolds:

Let G_j be the Green's function of p_j :

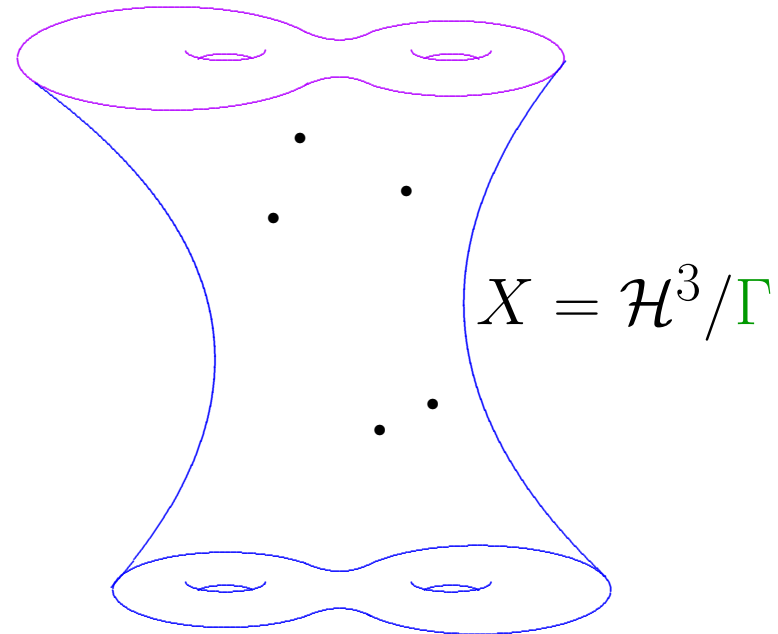

Construction of ASD 4-manifolds:

Let G_j be the Green's function of p_j :

$$\Delta G_j = 2\pi \delta_{p_j}, \quad G_j \rightarrow 0 \text{ at } \partial \bar{X}$$

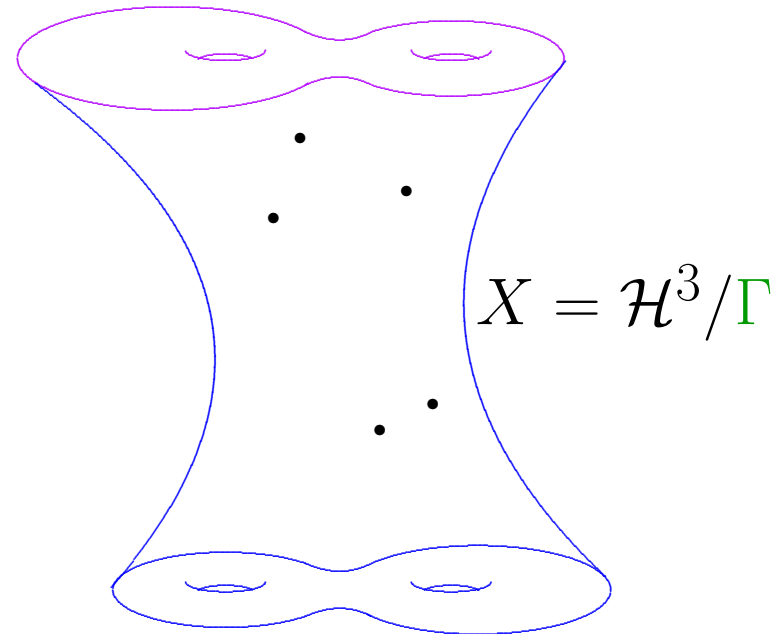

Construction of ASD 4-manifolds:

Let G_j be the Green's function of p_j , and set

$$V = 1 + \sum_{j=1}^k G_j.$$

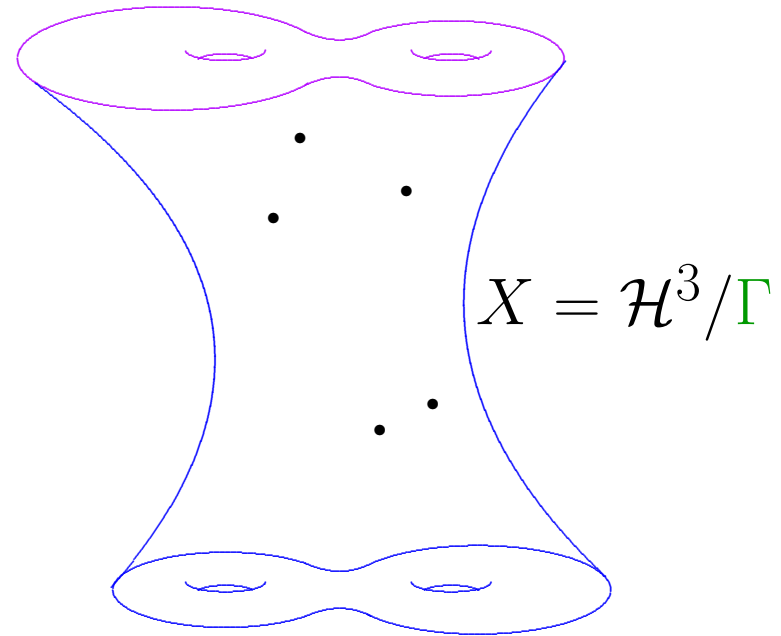

Construction of ASD 4-manifolds:

$$V = 1 + \sum_{j=1}^k G_j.$$

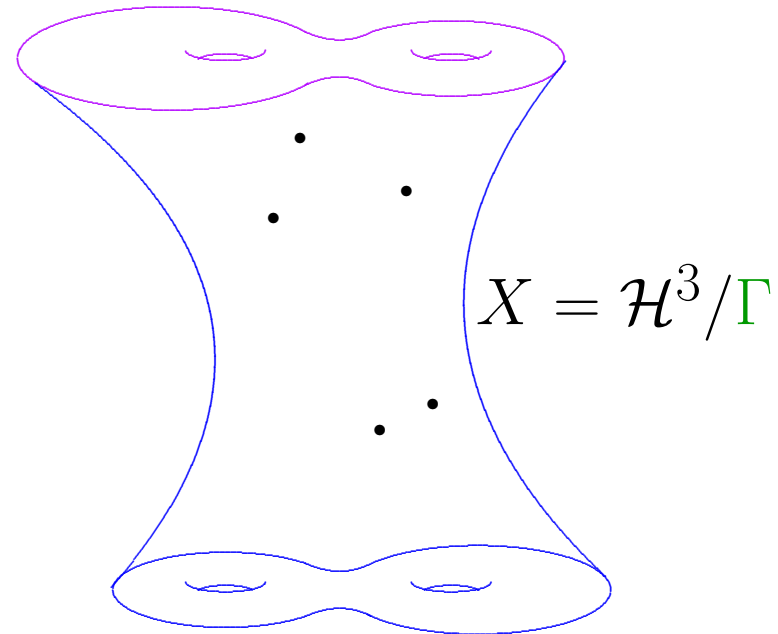

Construction of ASD 4-manifolds:

$$V = 1 + \sum_{j=1}^k G_j.$$

Choose $P \rightarrow (X - \{p_1, \dots, p_k\})$ circle bundle with connection form θ such that

$$d\theta = \star dV.$$

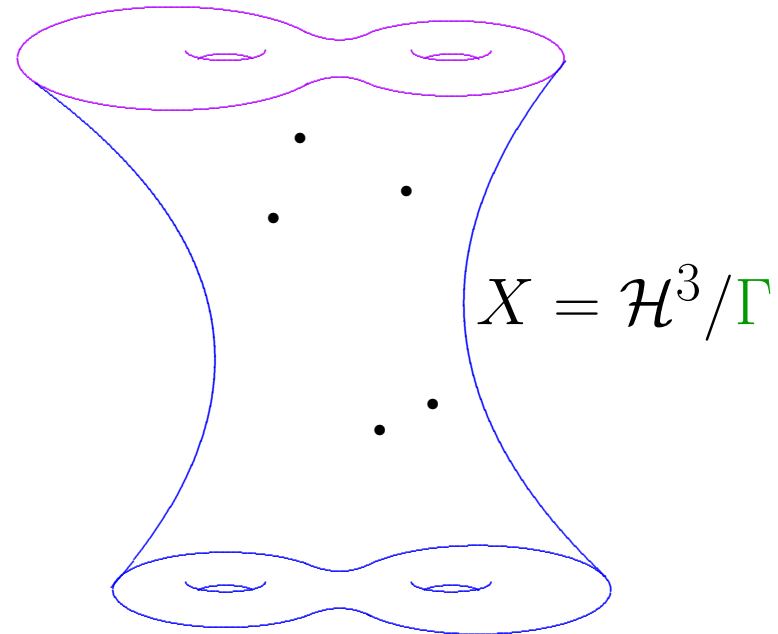

Construction of ASD 4-manifolds:

$$g = Vh + V^{-1}\theta^2$$

$$V = 1 + \sum_{j=1}^k G_j$$

$$d\theta = \star dV$$

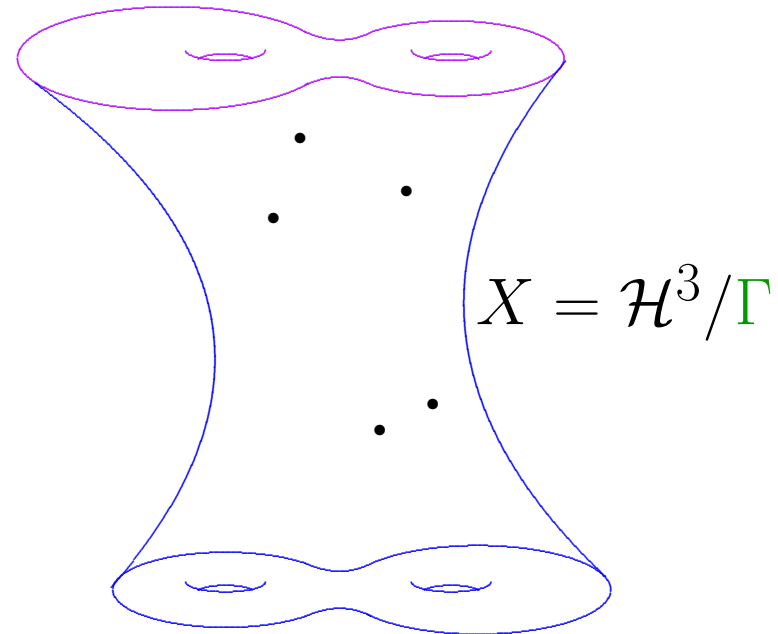

Construction of ASD 4-manifolds:

$$g = f(1 - f)[Vh + V^{-1}\theta^2]$$

$$V = 1 + \sum_{j=1}^k G_j$$

$$d\theta = \star dV$$

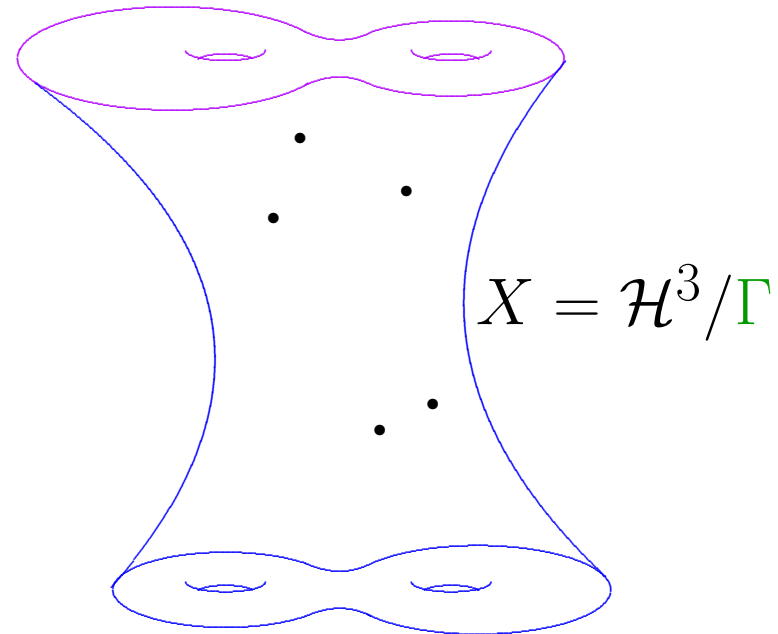

Construction of ASD 4-manifolds:

$$g = f(1 - f)[Vh + V^{-1}\theta^2]$$

$$M = P \cup \{\hat{p}_1, \dots, \hat{p}_k\} \cup \partial\bar{X}$$

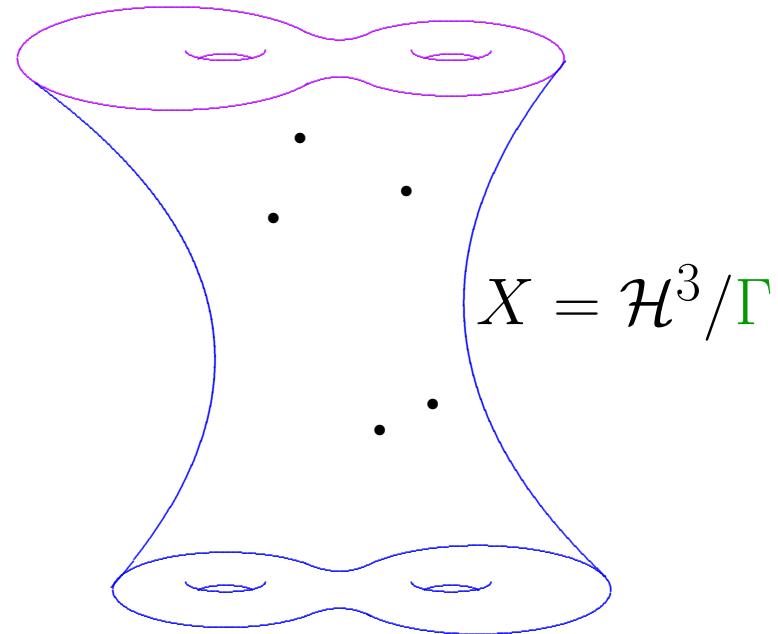

Construction of ASD 4-manifolds:

$$g = f(1 - f)[Vh + V^{-1}\theta^2]$$

$$\begin{array}{ccccccc}
 M & = & P & \cup & \{\hat{p}_1, \dots, \hat{p}_k\} & \cup & \partial \bar{X} \\
 \downarrow & & \downarrow & & \downarrow & & \downarrow \\
 \bar{X} & = & X - \{p_1, \dots, p_k\} & \cup & \{p_1, \dots, p_k\} & \cup & \partial \bar{X}
 \end{array}$$

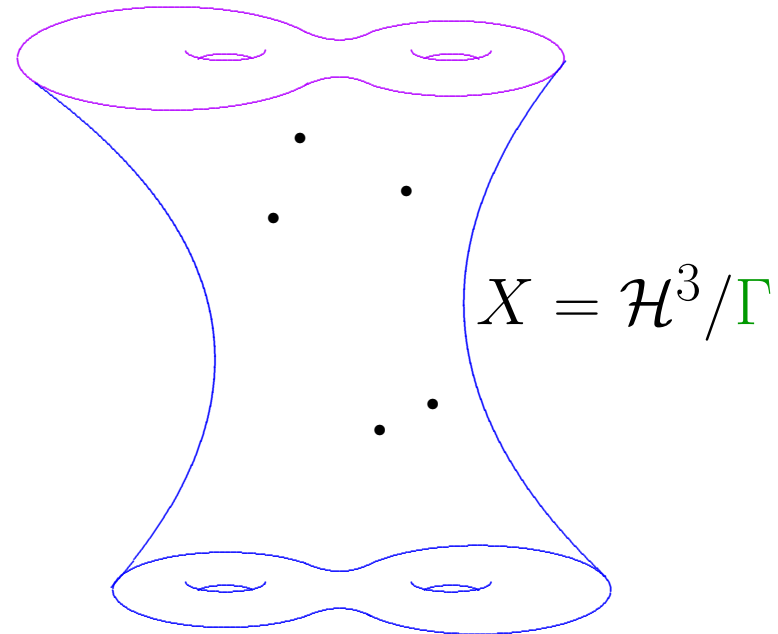

Construction of ASD 4-manifolds:

$$g = f(1 - f)[Vh + V^{-1}\theta^2]$$

$$M = P \cup \{\hat{p}_1, \dots, \hat{p}_k\} \cup \partial \bar{X}$$

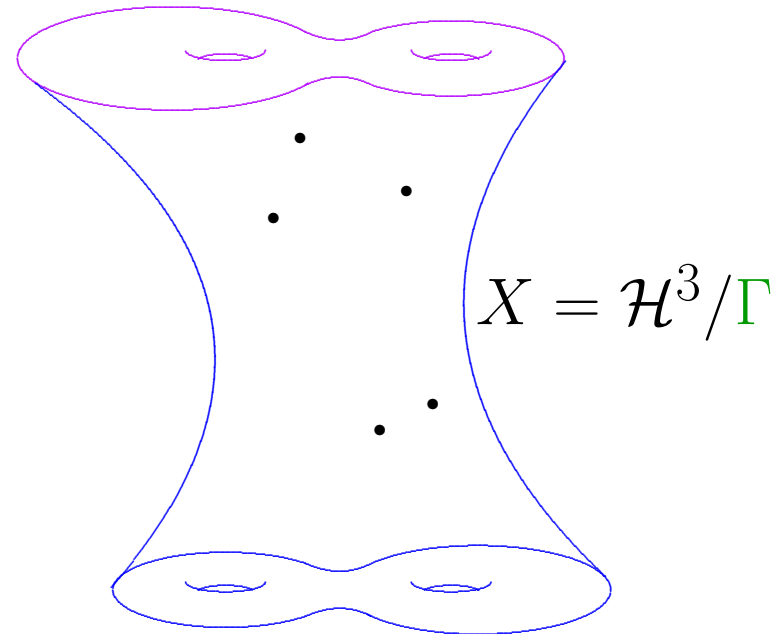

Construction of ASD 4-manifolds:

$$g = f(1 - f)[Vh + V^{-1}\theta^2]$$

$$M = P \cup \{\hat{p}_1, \dots, \hat{p}_k\} \cup \partial \bar{X}$$

$$\approx (\Sigma \times S^2) \# k \bar{\mathbb{C}P}_2$$

$$\overline{X} = \Sigma \times [0, 1]$$

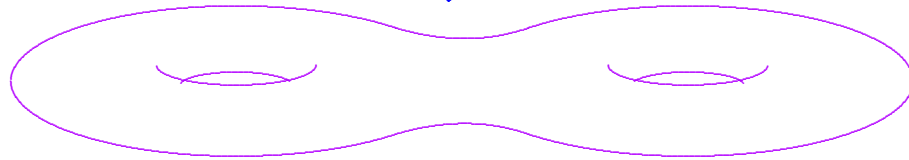

Σ

$$\overline{X} = \Sigma \times [0, 1]$$

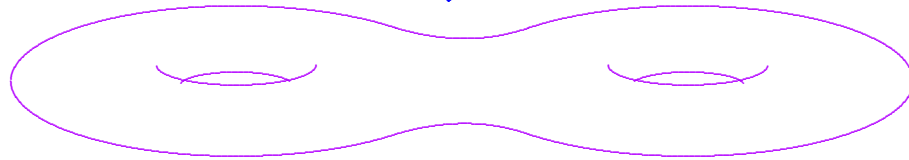

Σ

$$\overline{X} = \Sigma \times [0, 1]$$

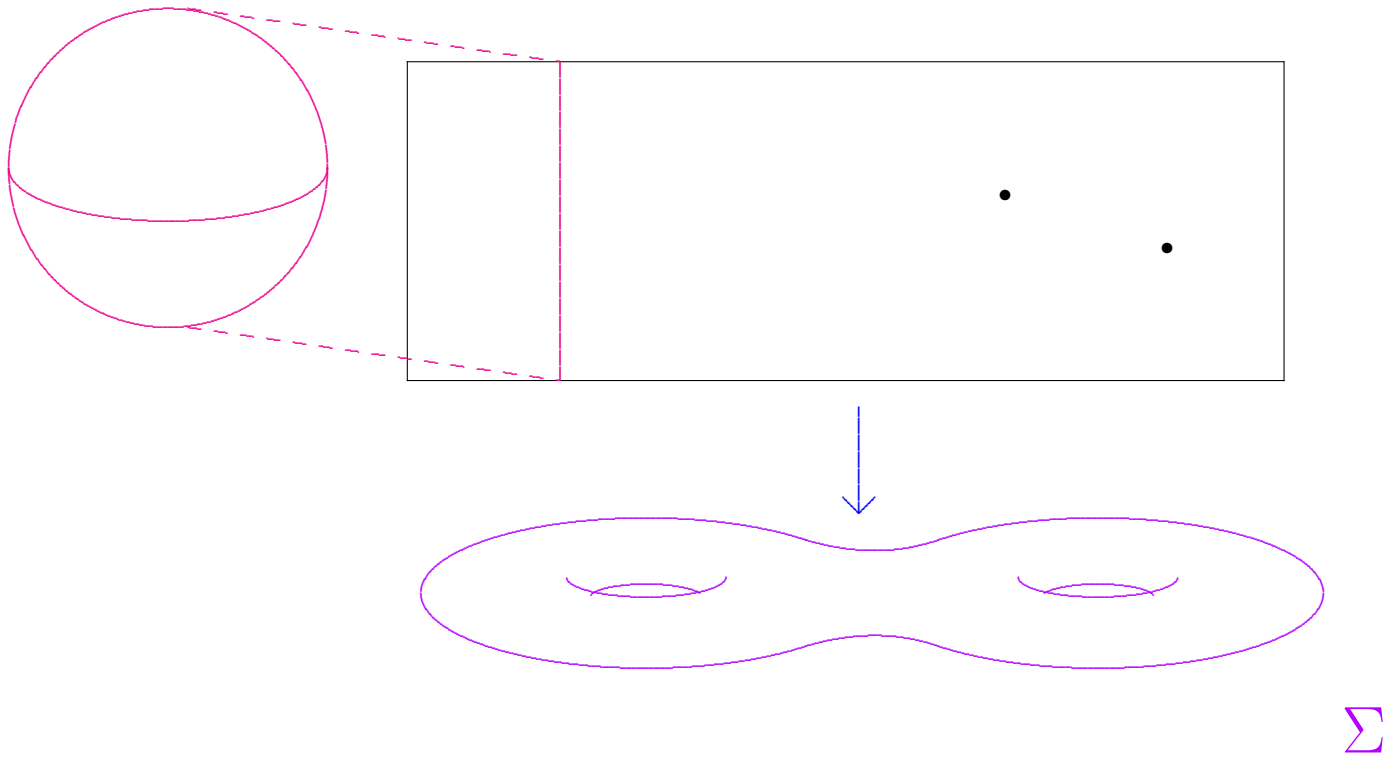

$$\overline{X} = \Sigma \times [0, 1]$$

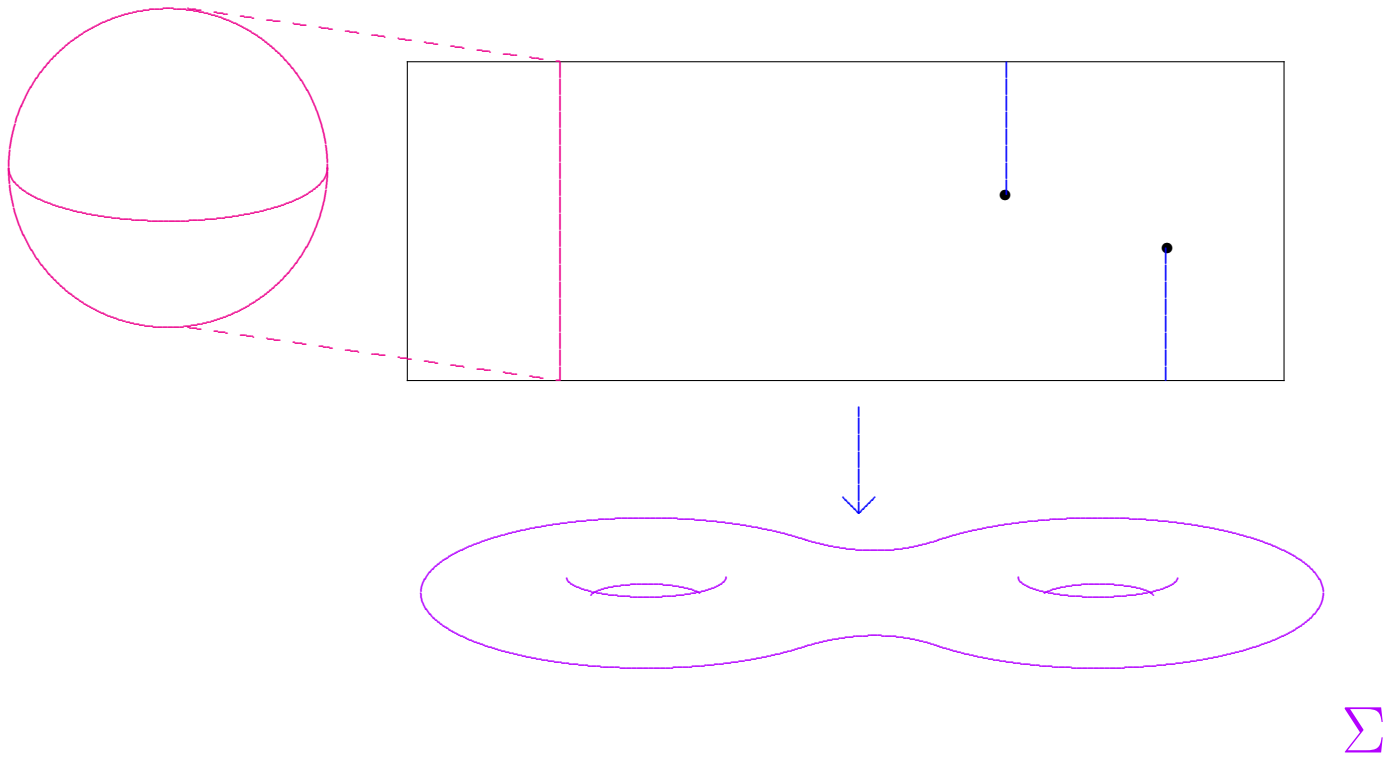

$$\overline{X} = \Sigma \times [0, 1]$$

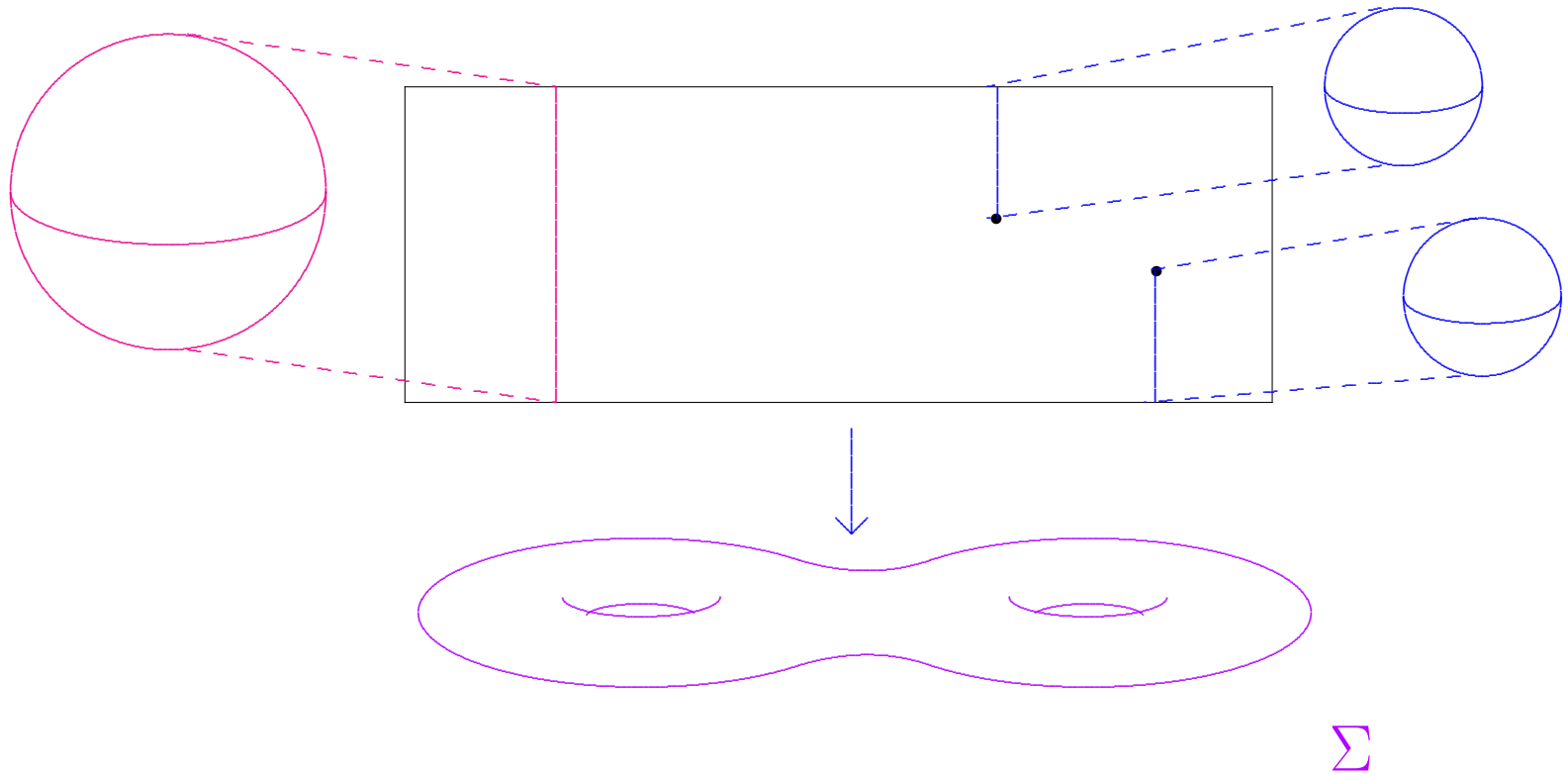

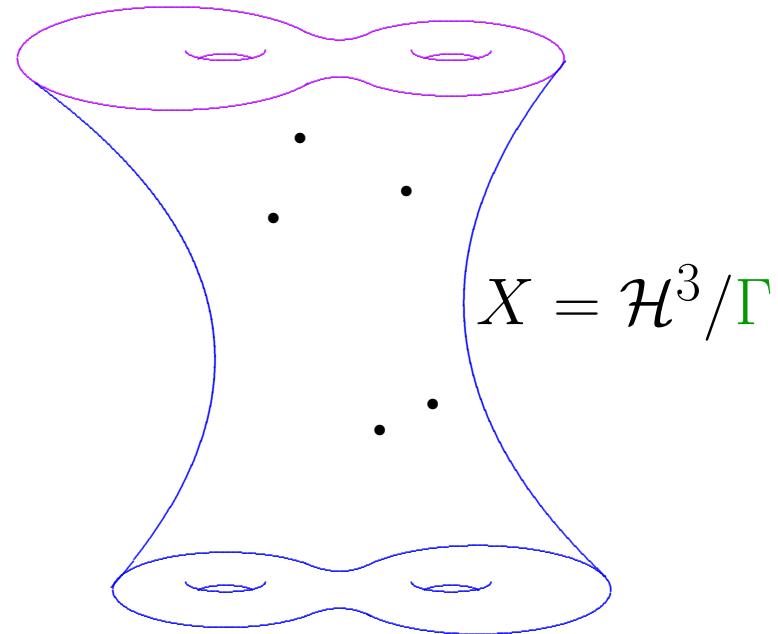

Construction of ASD 4-manifolds:

$$g = f(1 - f)[Vh + V^{-1}\theta^2]$$

$$M = P \cup \{\hat{p}_1, \dots, \hat{p}_k\} \cup \partial \bar{X}$$

$$\approx (\Sigma \times S^2) \# k \bar{\mathbb{C}P}_2$$

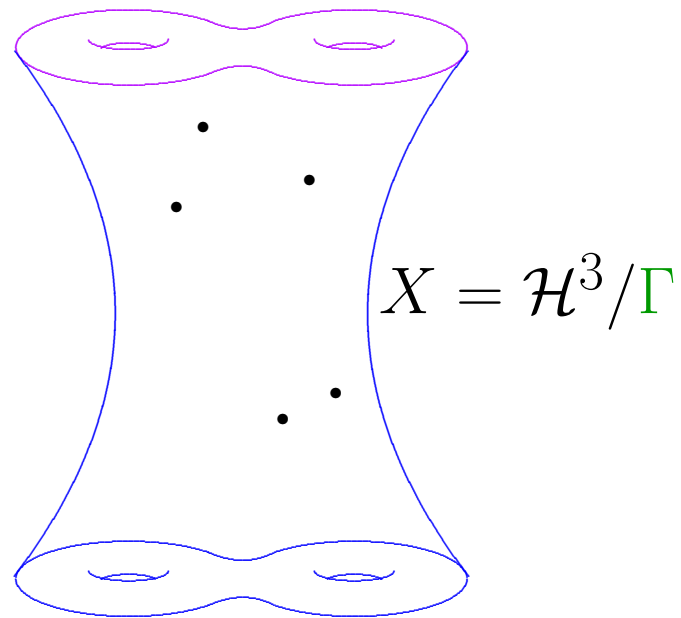

Construction of ASD 4-manifolds:

$$g = f(1 - f)[Vh + V^{-1}\theta^2]$$

$$M = P \cup \{\hat{p}_1, \dots, \hat{p}_k\} \cup \partial\bar{X}$$

Fuchsian case: $(\Sigma \times S^2) \# k\overline{\mathbb{C}\mathbb{P}}_2$ scalar-flat Kähler

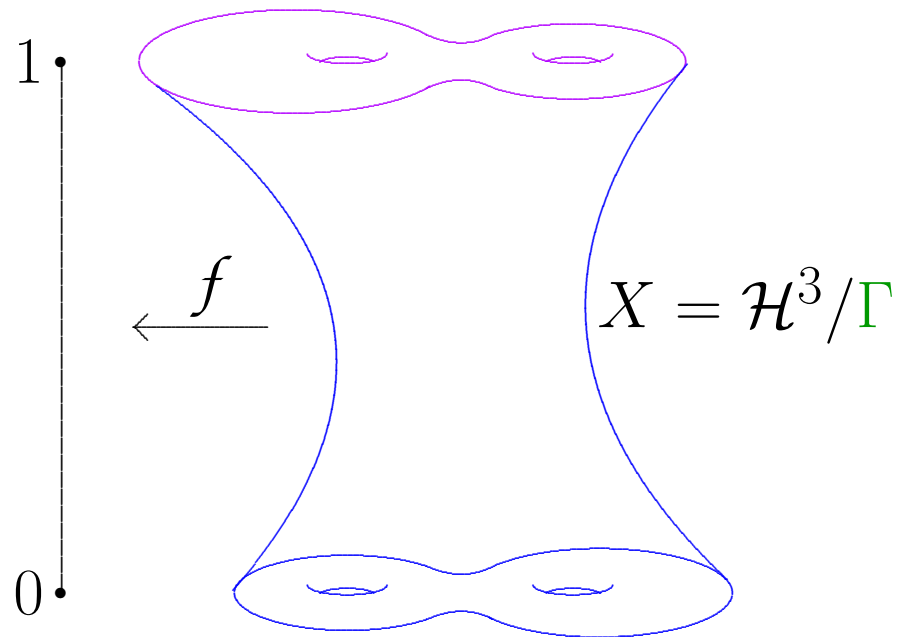

Γ quasi-Fuchsian

$$\overline{X} \approx \Sigma \times [0, 1]$$

Tunnel-Vision function:

$$f : \overline{X} \rightarrow [0, 1]$$

$$\Delta f = 0$$

Theorem.

Theorem. *Let $(M, [g])$ be ASD manifold*

Theorem. *Let $(M, [g])$ be ASD manifold arising from a quasi-Fuchsian 3-manifold (X, h)*

Theorem. *Let $(M, [g])$ be ASD manifold arising from a quasi-Fuchsian 3-manifold (X, h) and a configuration of points in X .*

Theorem. *Let $(M, [g])$ be ASD manifold arising from a quasi-Fuchsian 3-manifold (X, h) and a configuration of points in X .*

Then \exists almost-Kähler $g \in [g]$

Theorem. *Let $(M, [g])$ be ASD manifold arising from a quasi-Fuchsian 3-manifold (X, h) and a configuration of points in X .*

Then \exists almost-Kähler $g \in [g] \iff$

Theorem. *Let $(M, [g])$ be ASD manifold arising from a quasi-Fuchsian 3-manifold (X, h) and a configuration of points in X .*

Then \exists almost-Kähler $g \in [g] \iff$ tunnel-vision function $f : X \rightarrow (0, 1)$

Theorem. *Let $(M, [g])$ be ASD manifold arising from a quasi-Fuchsian 3-manifold (X, h) and a configuration of points in X .*

Then \exists almost-Kähler $g \in [g] \iff$ tunnel-vision function $f : X \rightarrow (0, 1)$ has no critical points.

Theorem. *Let $(M, [g])$ be ASD manifold arising from a quasi-Fuchsian 3-manifold (X, h) and a configuration of points in X .*

Then \exists almost-Kähler $g \in [g] \iff$ tunnel-vision function $f : X \rightarrow (0, 1)$ has no critical points.

Proof.

Theorem. *Let $(M, [g])$ be ASD manifold arising from a quasi-Fuchsian 3-manifold (X, h) and a configuration of points in X .*

Then \exists almost-Kähler $g \in [g] \iff$ tunnel-vision function $f : X \rightarrow (0, 1)$ has no critical points.

Proof.

$$b_+[(\Sigma \times S^2) \# k \overline{\mathbb{C}P}_2] = 1.$$

Theorem. *Let $(M, [g])$ be ASD manifold arising from a quasi-Fuchsian 3-manifold (X, h) and a configuration of points in X .*

Then \exists almost-Kähler $g \in [g] \iff$ tunnel-vision function $f : X \rightarrow (0, 1)$ has no critical points.

Proof.

$$b_+[(\Sigma \times S^2) \# k \overline{\mathbb{C}P}_2] = 1.$$

$$\omega = df \wedge \theta + V \star df.$$

Theorem. *Let $(M, [g])$ be ASD manifold arising from a quasi-Fuchsian 3-manifold (X, h) and a configuration of points in X .*

Then \exists almost-Kähler $g \in [g] \iff$ tunnel-vision function $f : X \rightarrow (0, 1)$ has no critical points.

Proof.

$$b_+[(\Sigma \times S^2) \# k\overline{\mathbb{C}P}_2] = 1.$$

$$\omega = df \wedge \theta + V \star df.$$



Lemma.

Lemma. *For any piecewise smooth Jordan curve*

$$\gamma \subset \mathbb{C}$$

Lemma. *For any piecewise smooth Jordan curve $\gamma \subset \mathbb{C}$ and any $\varepsilon > 0$,*

Lemma. *For any piecewise smooth Jordan curve $\gamma \subset \mathbb{C}$ and any $\varepsilon > 0$, there is a positive integer N*

Lemma. For any piecewise smooth Jordan curve $\gamma \subset \mathbb{C}$ and any $\varepsilon > 0$, there is a positive integer N such that, for every compact oriented surface Σ

Lemma. *For any piecewise smooth Jordan curve $\gamma \subset \mathbb{C}$ and any $\varepsilon > 0$, there is a positive integer N such that, for every compact oriented surface Σ of genus $g \geq N$,*

Lemma. *For any piecewise smooth Jordan curve $\gamma \subset \mathbb{C}$ and any $\varepsilon > 0$, there is a positive integer N such that, for every compact oriented surface Σ of genus $g \geq N$, there is quasi-Fuchsian group $\Gamma \cong \pi_1(\Sigma)$*

Lemma. *For any piecewise smooth Jordan curve $\gamma \subset \mathbb{C}$ and any $\varepsilon > 0$, there is a positive integer N such that, for every compact oriented surface Σ of genus $g \geq N$, there is quasi-Fuchsian group $\Gamma \cong \pi_1(\Sigma)$ whose limit set $\Lambda(\Gamma) \subset \mathbb{C} \subset \mathbb{CP}_1$*

Lemma. *For any piecewise smooth Jordan curve $\gamma \subset \mathbb{C}$ and any $\varepsilon > 0$, there is a positive integer N such that, for every compact oriented surface Σ of genus $g \geq N$, there is quasi-Fuchsian group $\Gamma \cong \pi_1(\Sigma)$ whose limit set $\Lambda(\Gamma) \subset \mathbb{C} \subset \mathbb{CP}_1$ is within Hausdorff distance ε of γ .*

Lemma. For any piecewise smooth Jordan curve $\gamma \subset \mathbb{C}$ and any $\varepsilon > 0$, there is a positive integer N such that, for every compact oriented surface Σ of genus $g \geq N$, there is quasi-Fuchsian group $\Gamma \cong \pi_1(\Sigma)$ whose limit set $\Lambda(\Gamma) \subset \mathbb{C} \subset \mathbb{CP}_1$ is within Hausdorff distance ε of γ .

If γ is invariant under $\zeta \mapsto -\zeta$, and if g is even, we can also arrange for $\Lambda(\Gamma)$ to also be invariant under reflection through the origin.

Lemma. For any piecewise smooth Jordan curve $\gamma \subset \mathbb{C}$ and any $\varepsilon > 0$, there is a positive integer N such that, for every compact oriented surface Σ of genus $g \geq N$, there is quasi-Fuchsian group $\Gamma \cong \pi_1(\Sigma)$ whose limit set $\Lambda(\Gamma) \subset \mathbb{C} \subset \mathbb{CP}_1$ is within Hausdorff distance ε of γ .

If γ is invariant under $\zeta \mapsto -\zeta$, and if g is even, we can also arrange for $\Lambda(\Gamma)$ to also be invariant under reflection through the origin.

Ahlfors-Bers: Quasi-conformal mappings

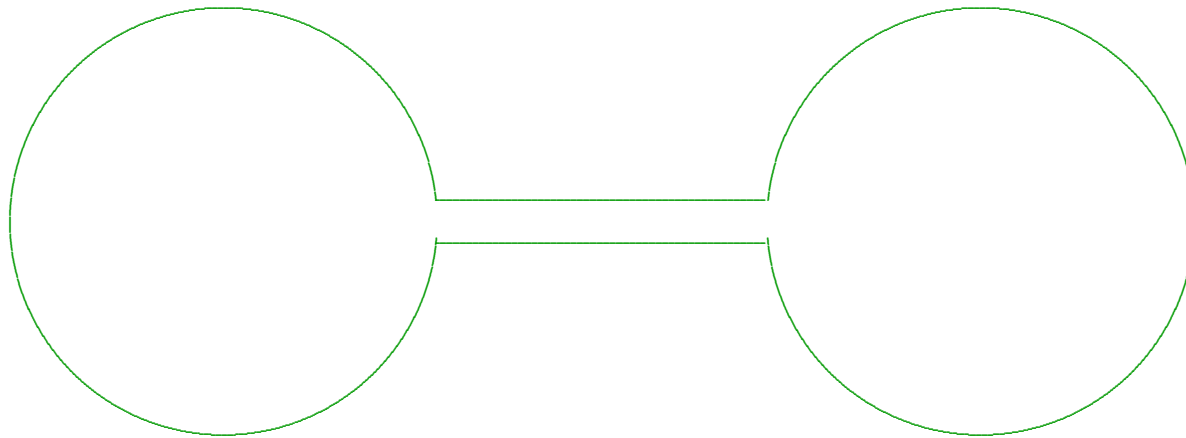

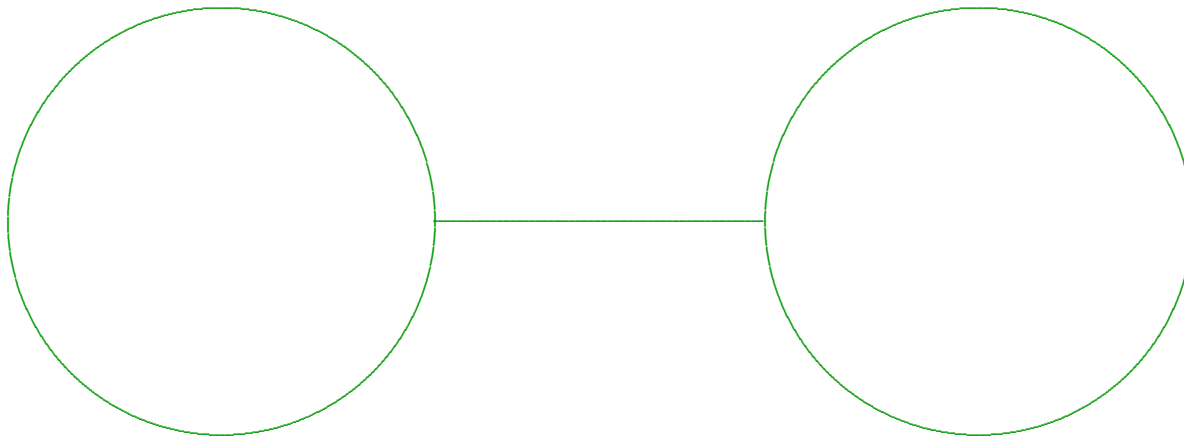

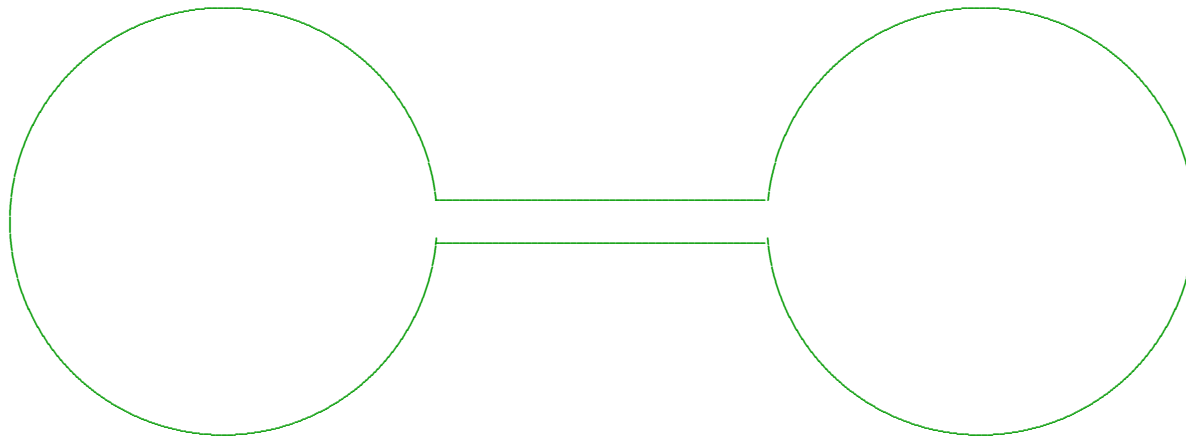

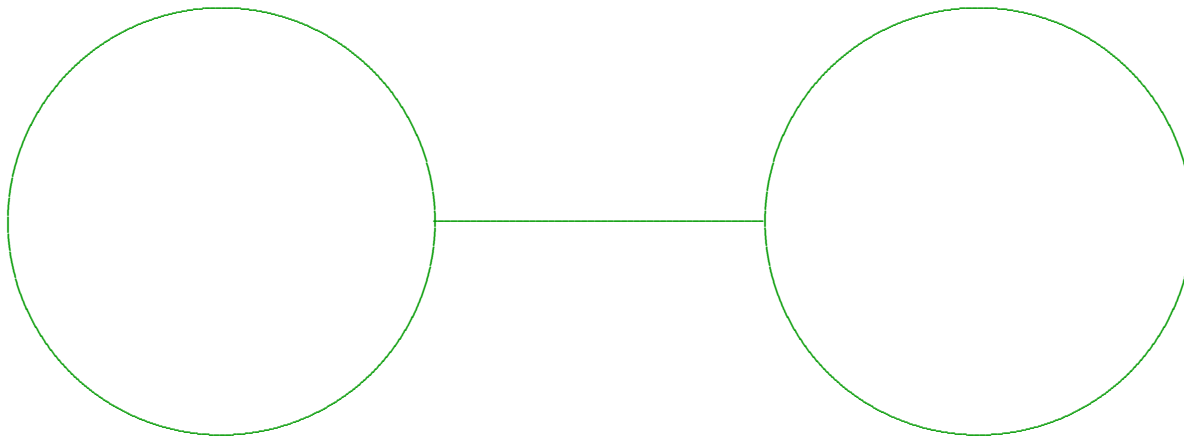

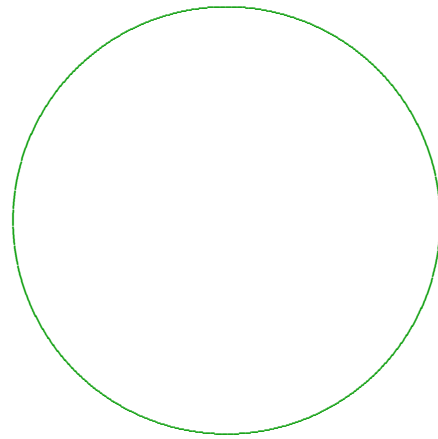
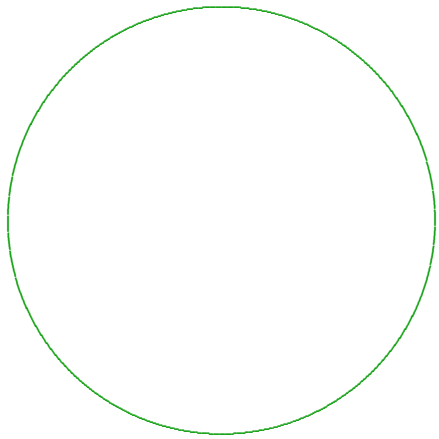

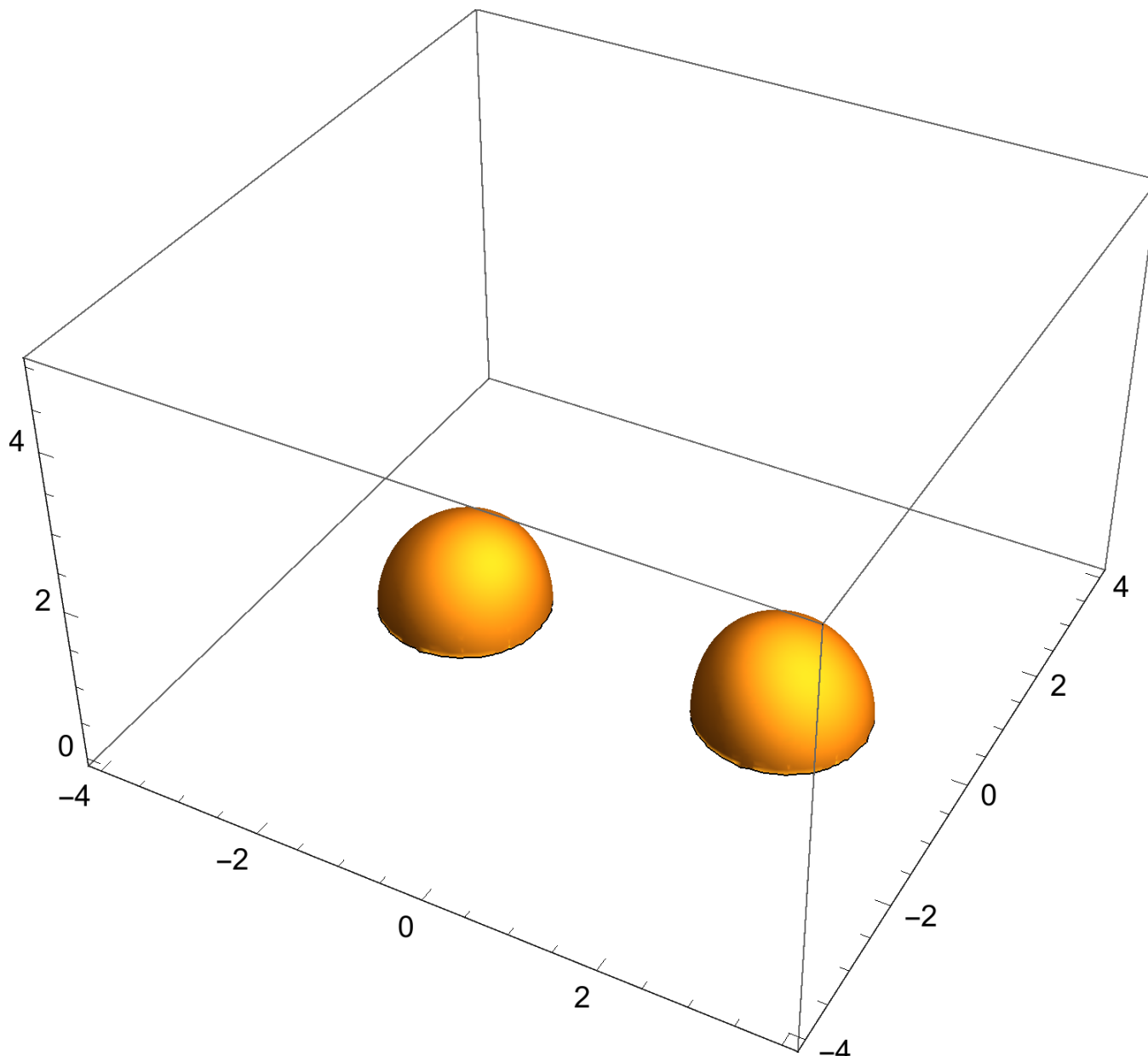

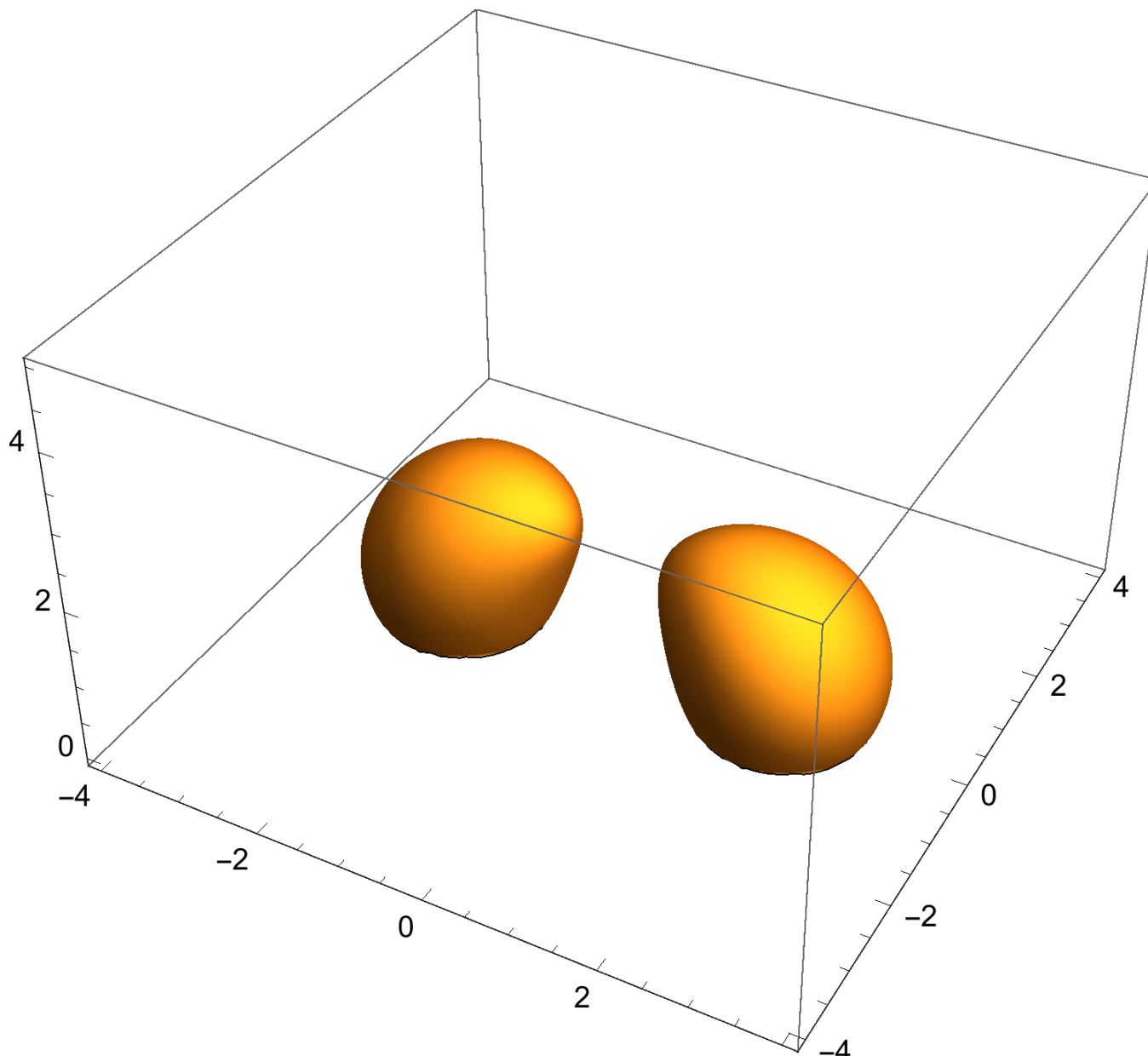

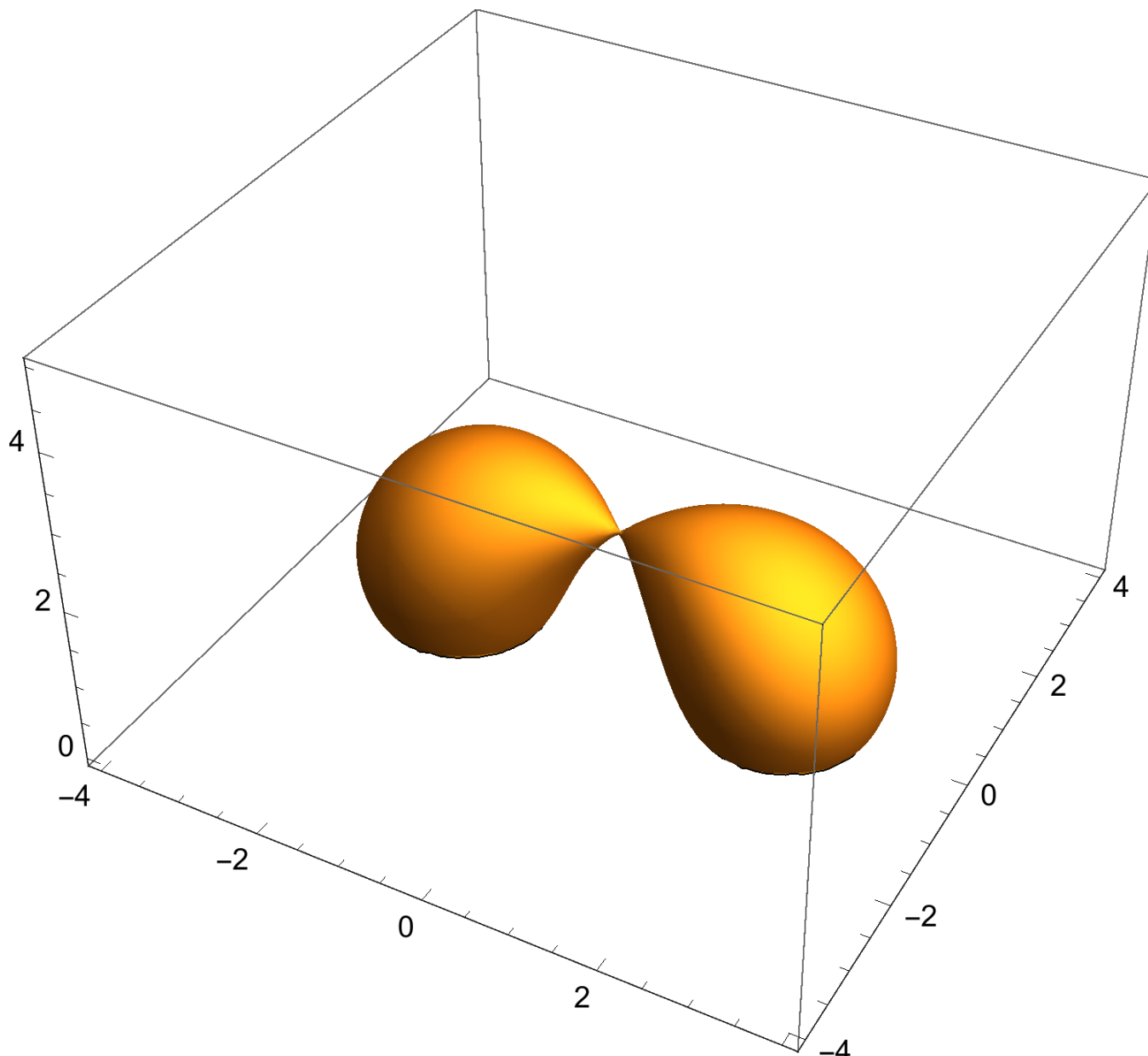

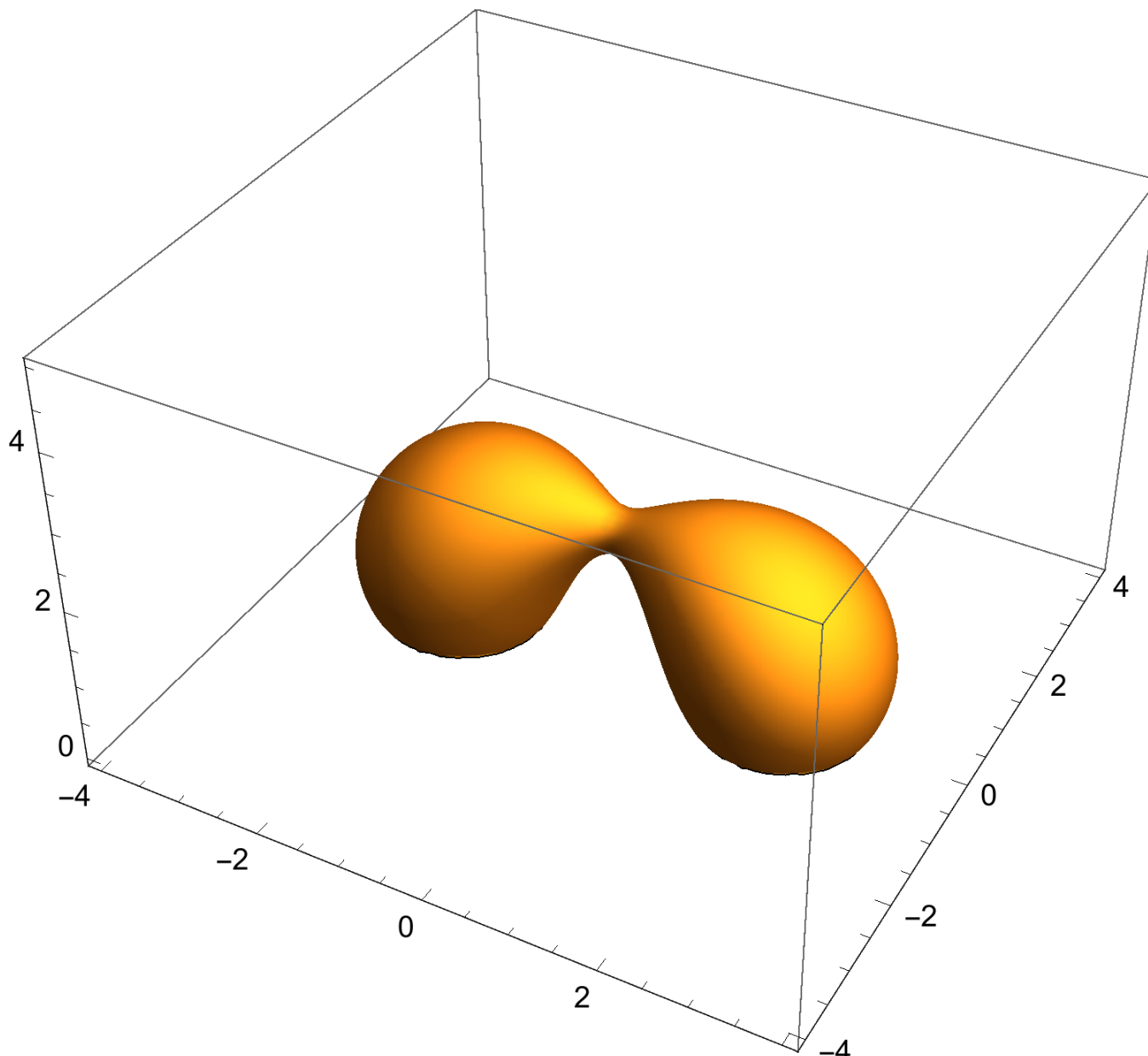

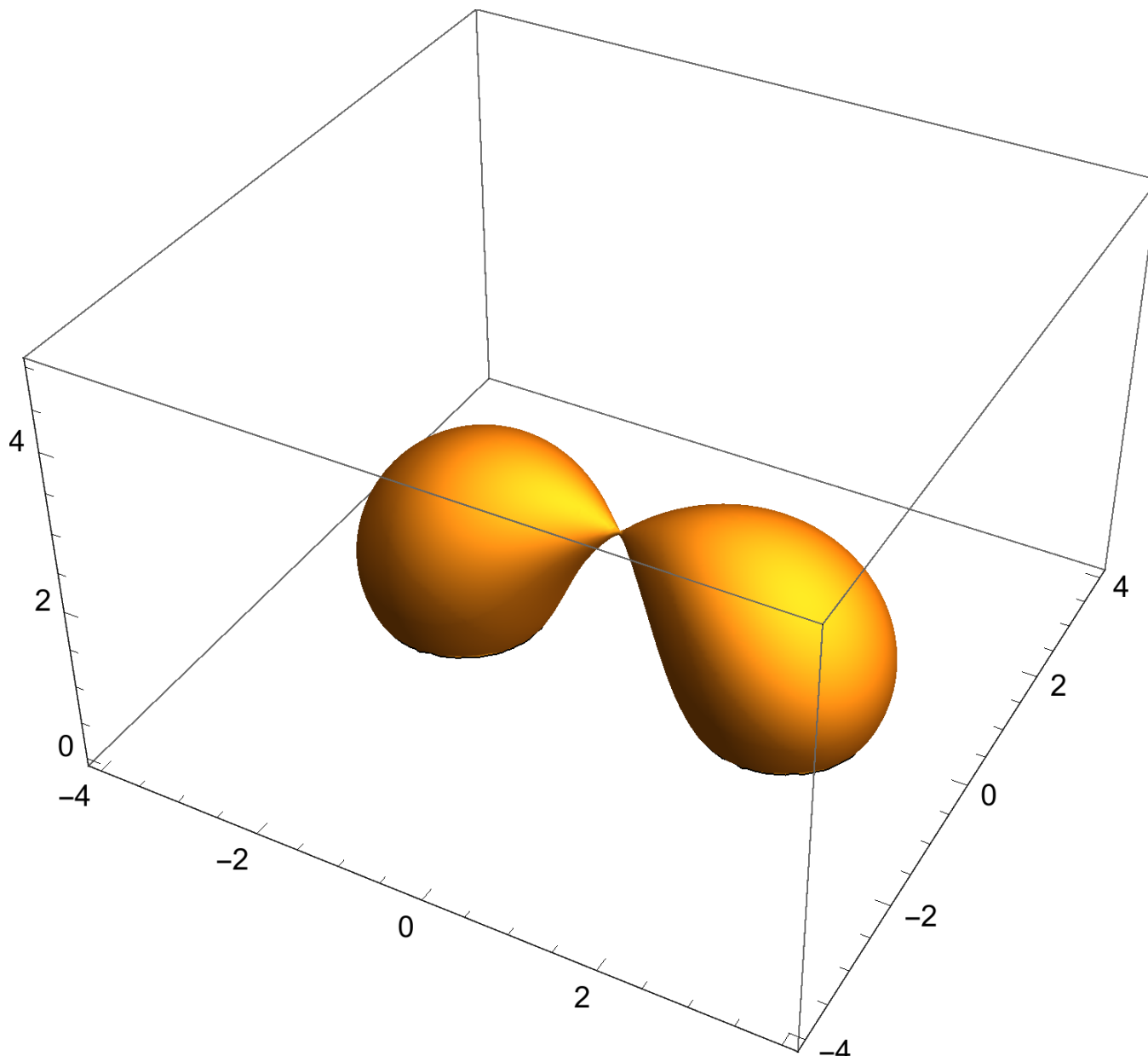

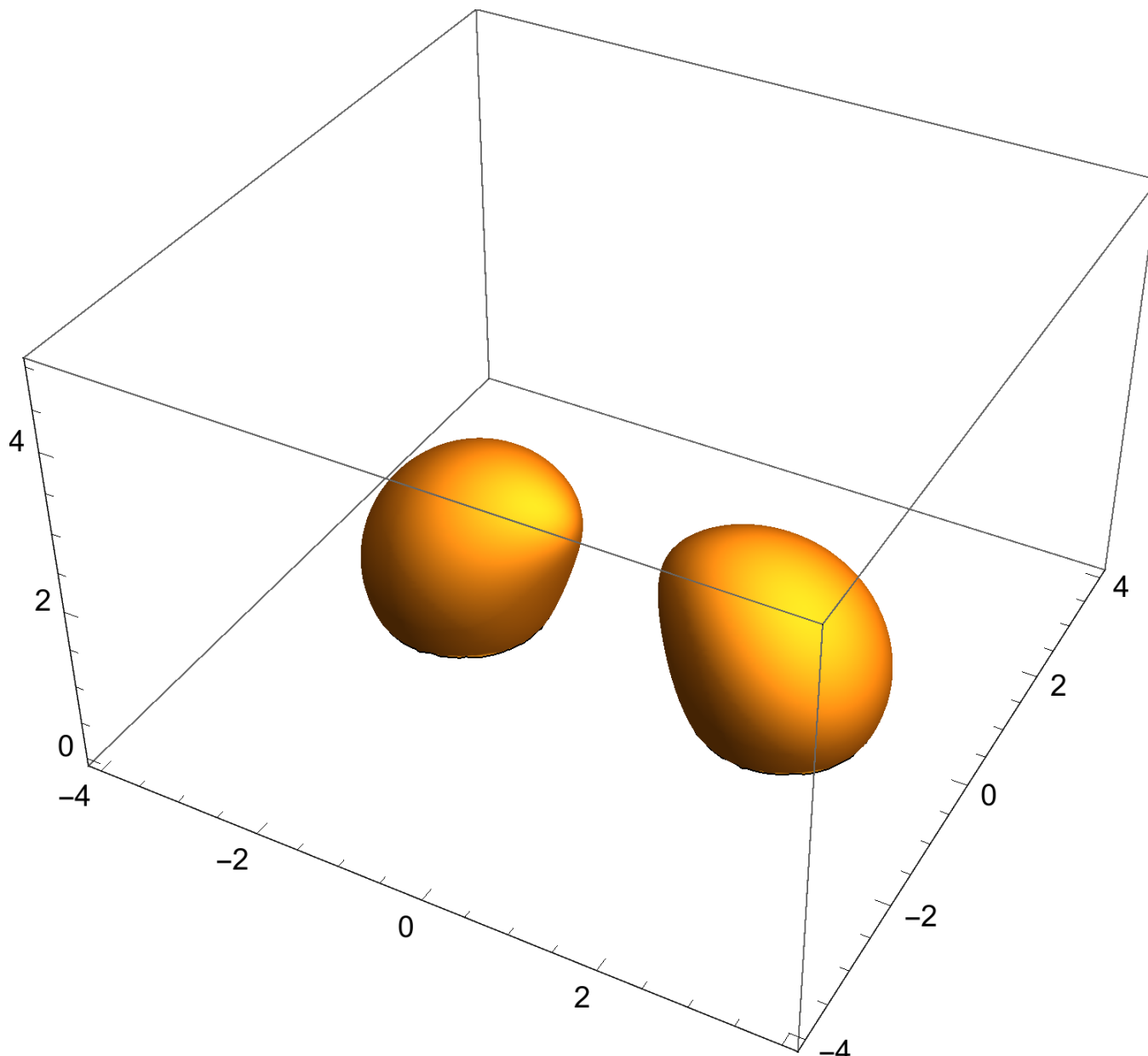

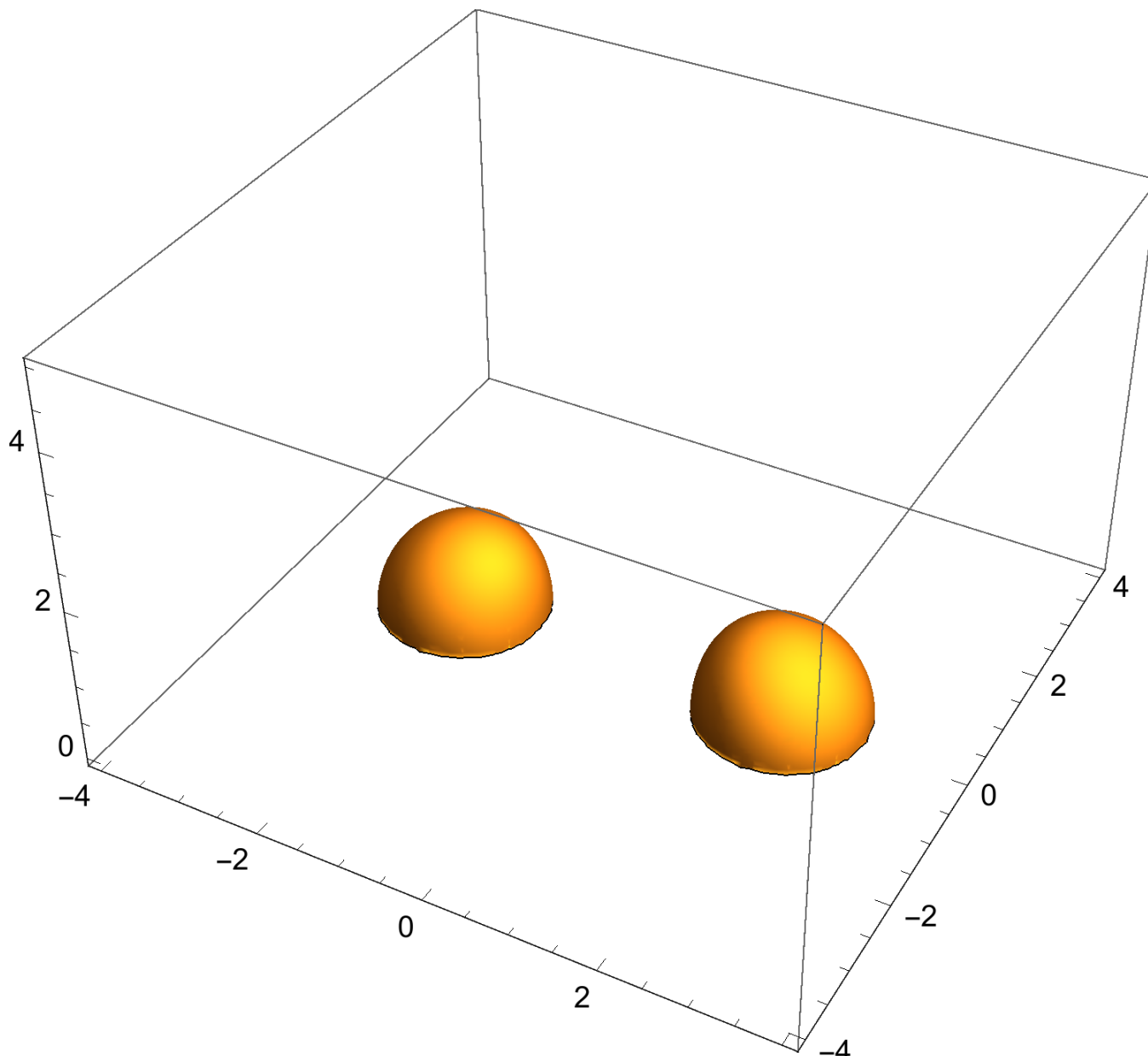

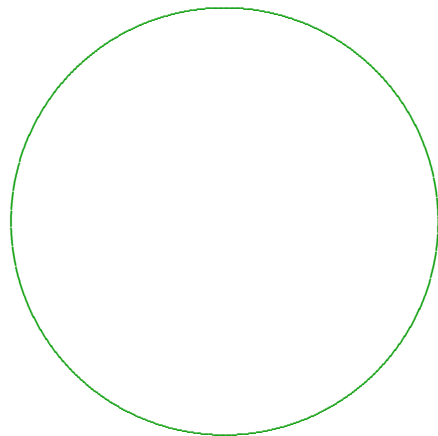
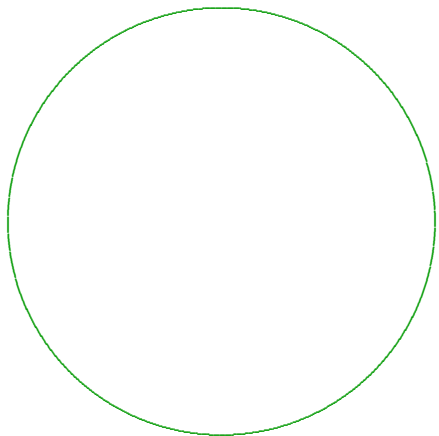

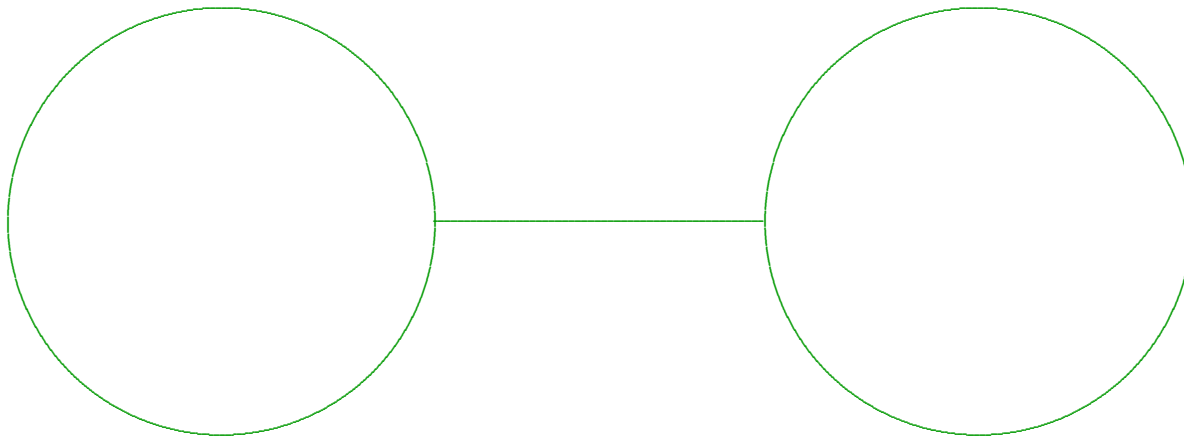

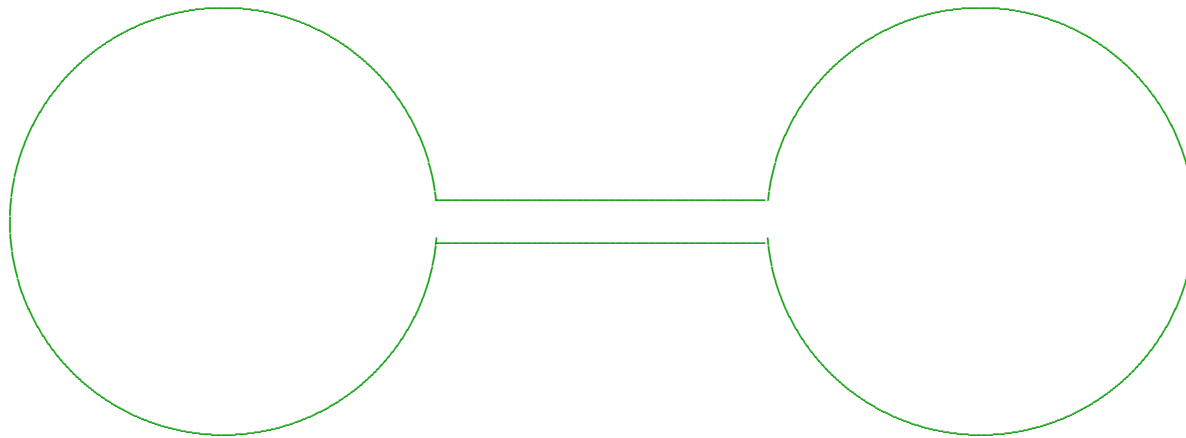

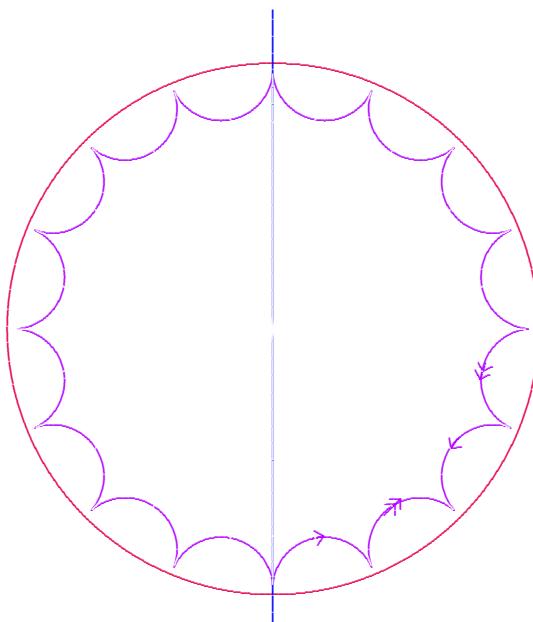
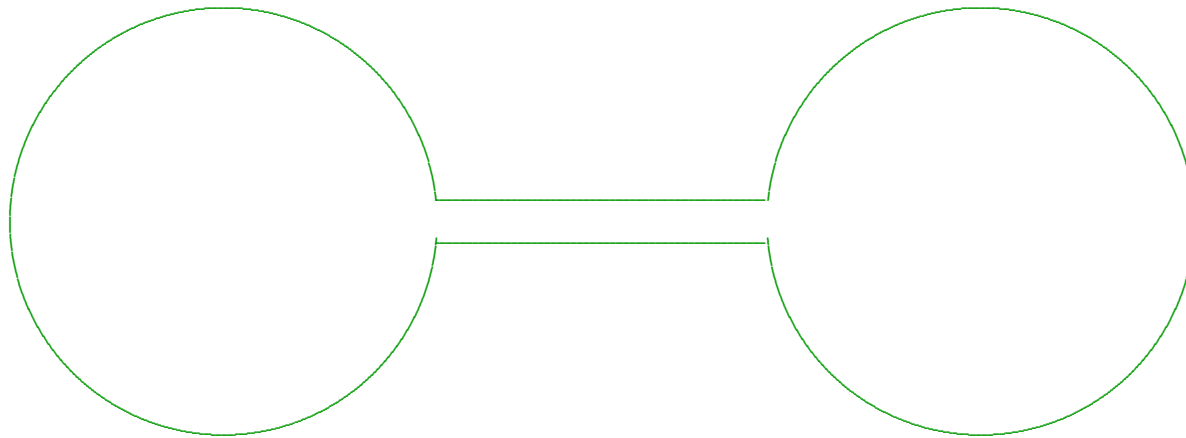

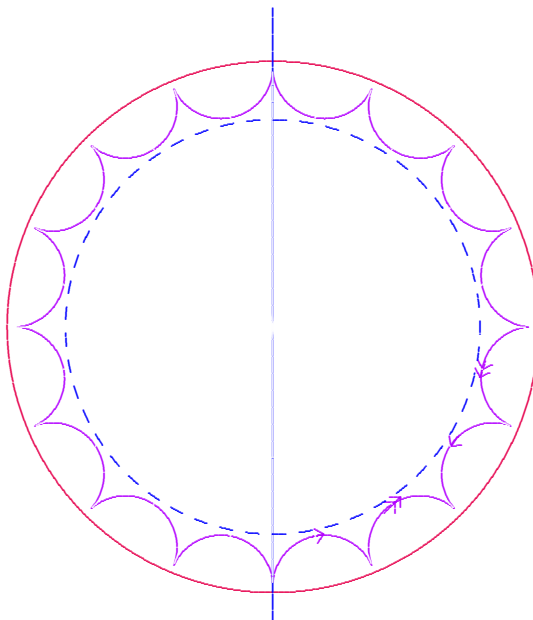
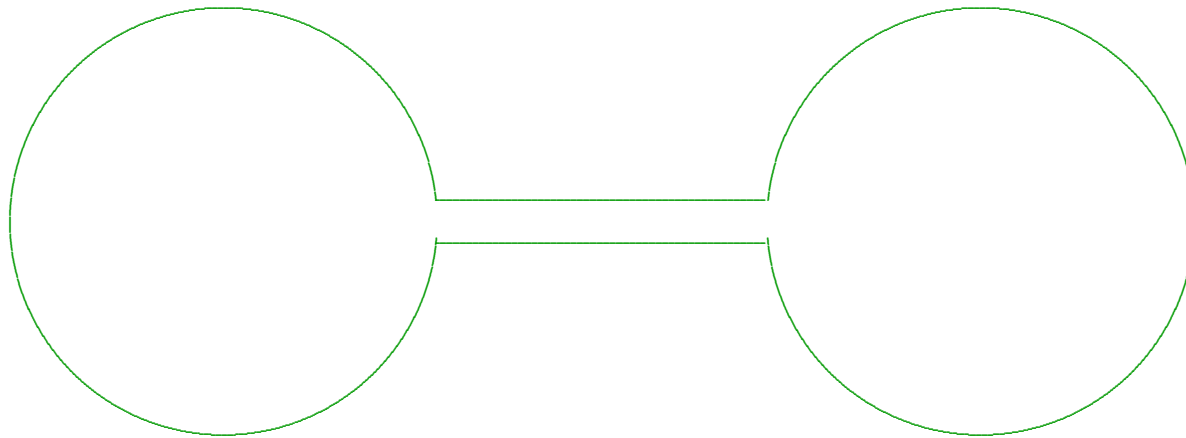

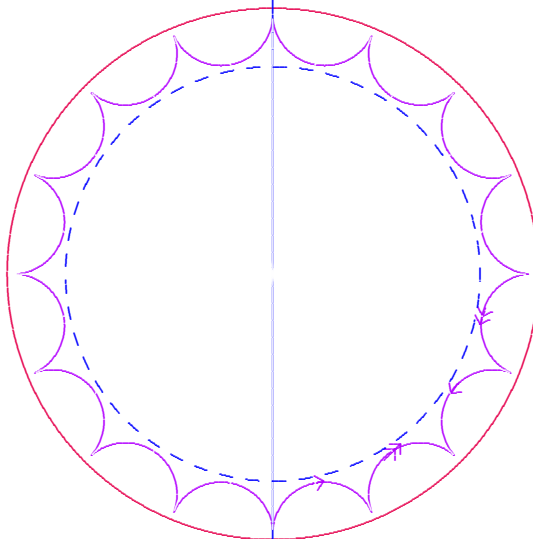
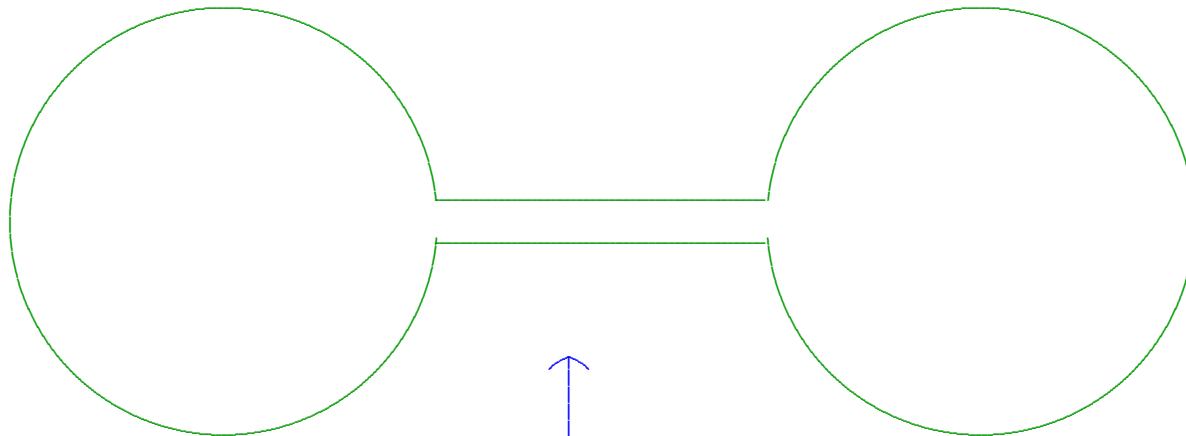

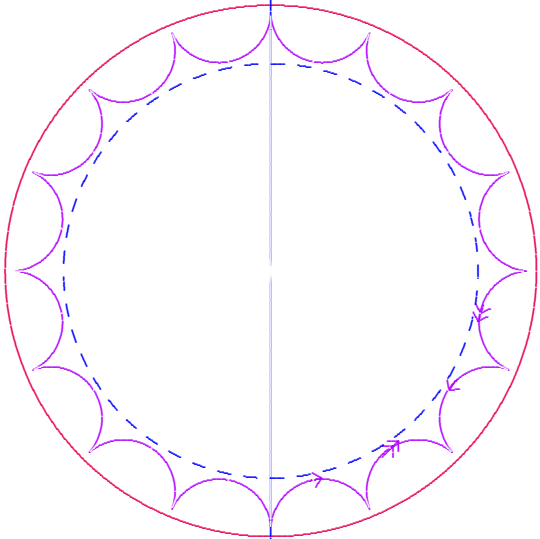
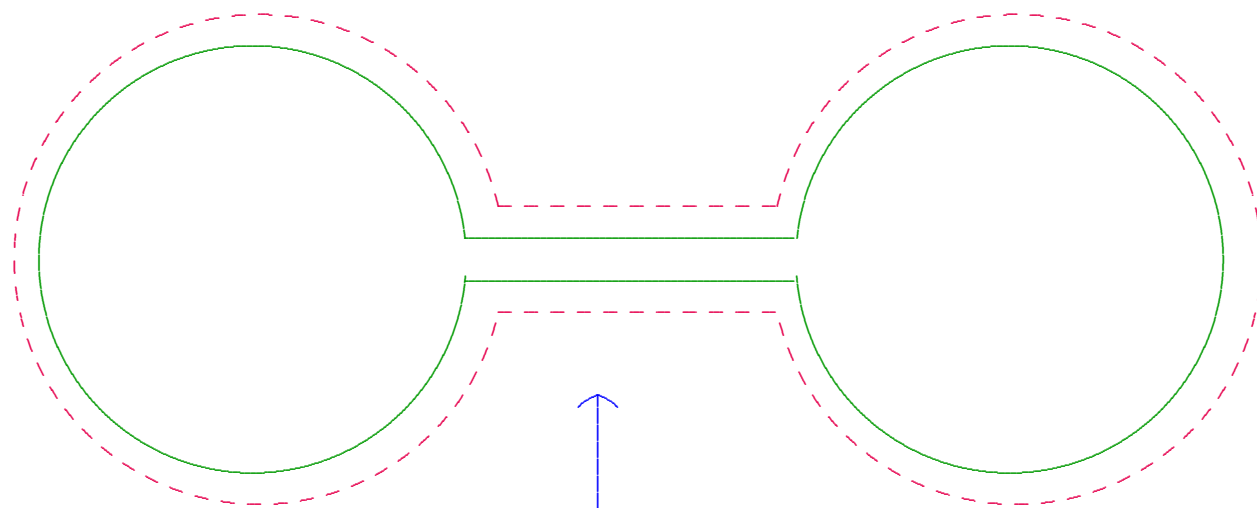

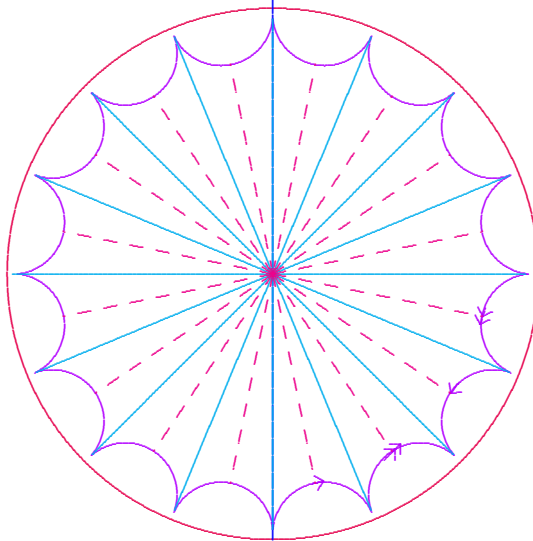
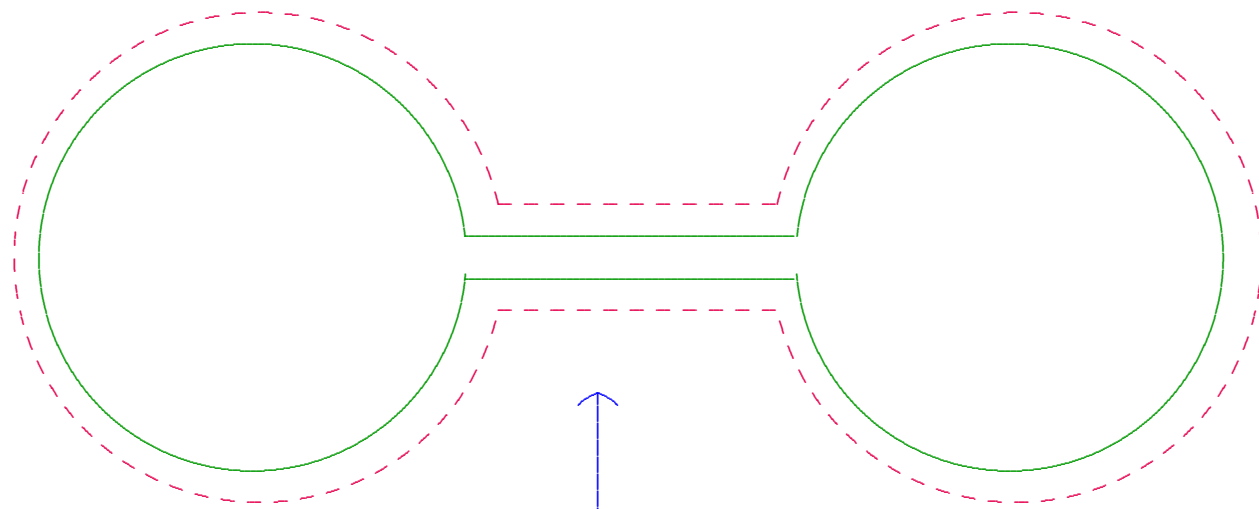

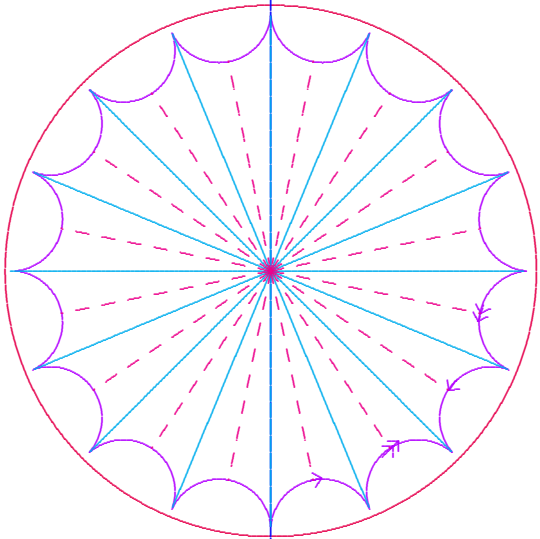
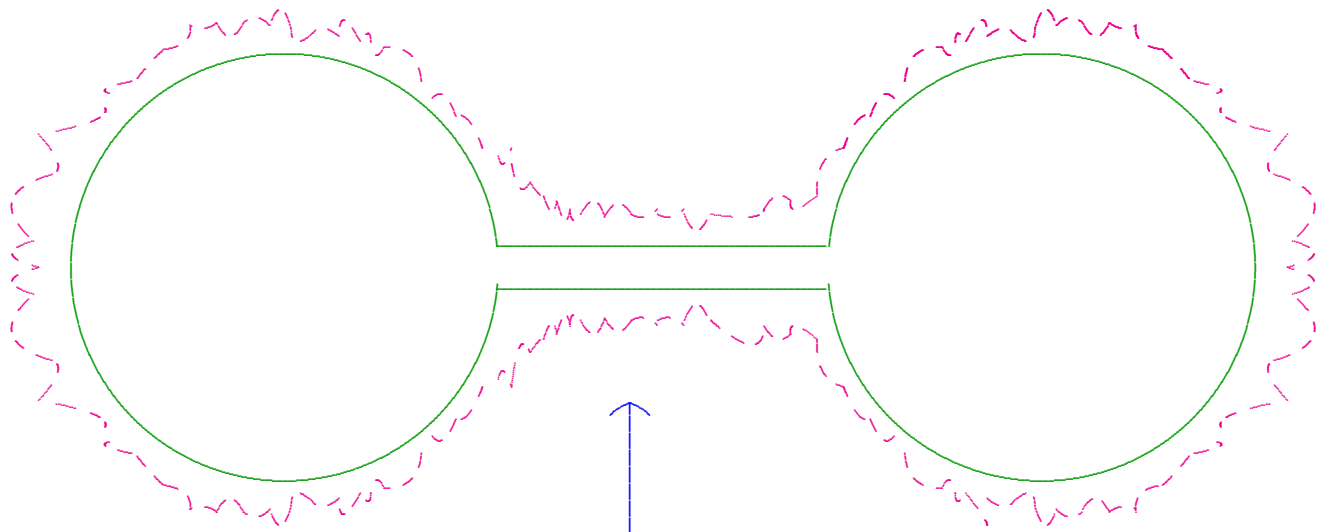

Theorem A. Consider 4-manifolds $M = \Sigma \times S^2$, where Σ compact Riemann surface of genus g .

Then \forall even $g \gg 0$, \exists family $[g_t]$, $t \in [0, 1]$, of locally-conformally-flat classes on M , such that

- \exists scalar-flat Kähler metric $g_0 \in [g_0]$; but
- \nexists almost-Kähler metric $g \in [g_1]$.

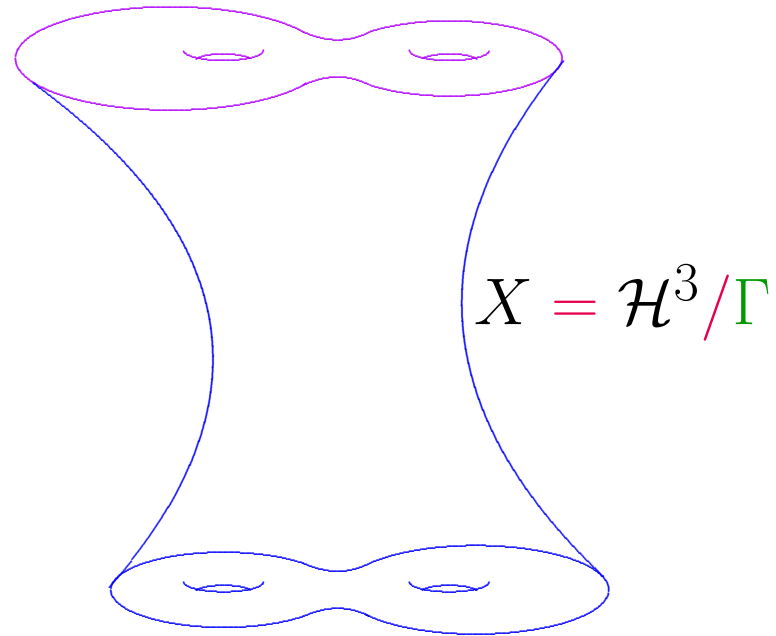

Construction of conformally flat 4-manifolds:

$$M = [\bar{X} \times S^1] / \sim$$

$$g = f(1 - f)[h + dt^2]$$

Theorem B. Fix an integer $k \geq 2$, and then consider the 4-manifolds $M = (\Sigma \times S^2) \#^k \overline{\mathbb{C}\mathbb{P}}_2$, where Σ compact Riemann surface of genus g .

Then \forall even $g \gg 0$, \exists family $[g_t]$, $t \in [0, 1]$, of anti-self-dual conformal classes on M , such that

- \exists scalar-flat Kähler metric $g_0 \in [g_0]$; but
- \nexists almost-Kähler metric $g \in [g_1]$.

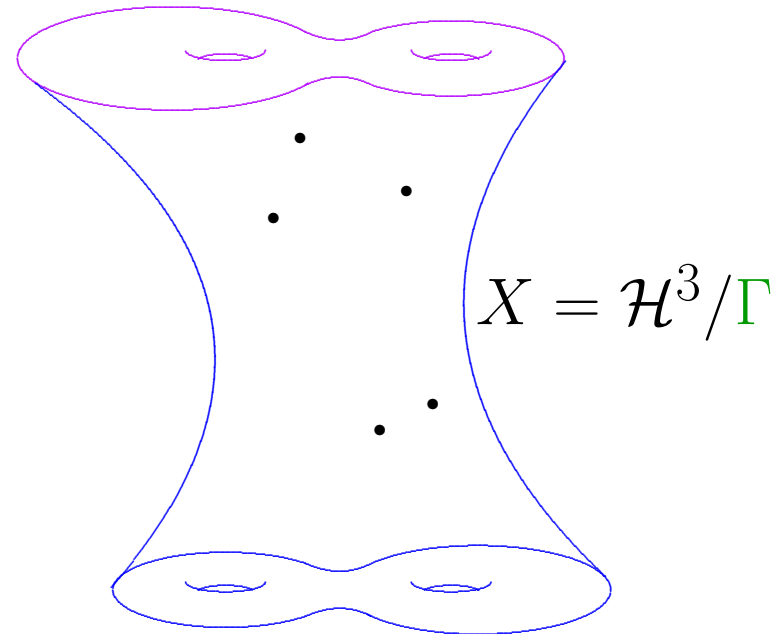

Construction of ASD 4-manifolds:

$$g = f(1 - f)[Vh + V^{-1}\theta^2]$$

$$V = 1 + \sum_{j=1}^k G_j$$

$$d\theta = \star dV$$

Theorem B. Fix an integer $k \geq 2$, and then consider the 4-manifolds $M = (\Sigma \times S^2) \#^k \overline{\mathbb{C}\mathbb{P}}_2$, where Σ compact Riemann surface of genus g .

Then \forall even $g \gg 0$, \exists family $[g_t]$, $t \in [0, 1]$, of anti-self-dual conformal classes on M , such that

- \exists scalar-flat Kähler metric $g_0 \in [g_0]$; but
- \nexists almost-Kähler metric $g \in [g_1]$.

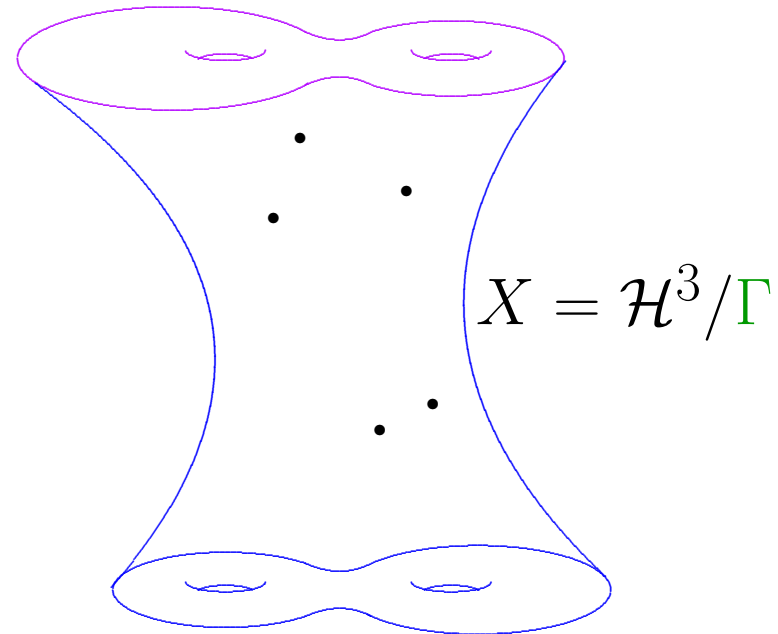

Construction of ASD 4-manifolds:

$$g = f(1 - f)[Vh + V^{-1}\theta^2]$$

$$V = 1 + \sum_{j=1}^k G_j$$

$$d\theta = \star dV$$

Vielen Dank für die Einladung!

