

Mass, Scalar Curvature, &

Kähler Geometry, II

Claude LeBrun

Stony Brook University

Seminario de Geometría
ICMAT, November 5, 2018

Definition. Complete, non-compact n -manifold (M^n, g) is asymptotically locally Euclidean

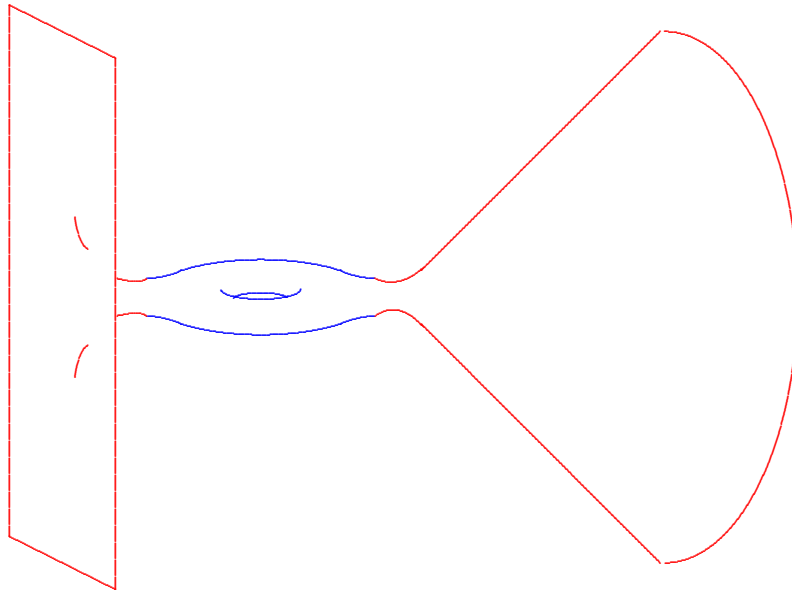

Definition. Complete, non-compact n -manifold (M^n, g) is asymptotically locally Euclidean (ALE)

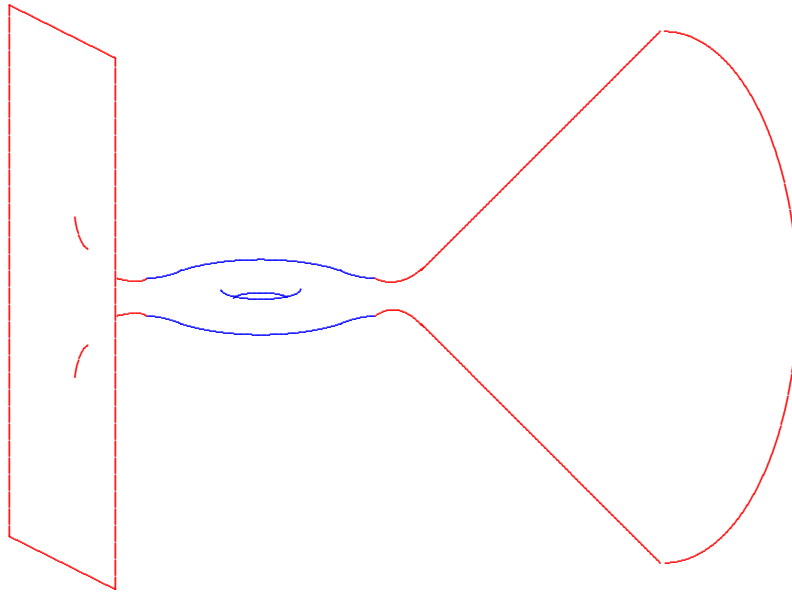

Definition. Complete, non-compact n -manifold (M^n, g) is asymptotically locally Euclidean (ALE) if \exists compact set $K \subset M$

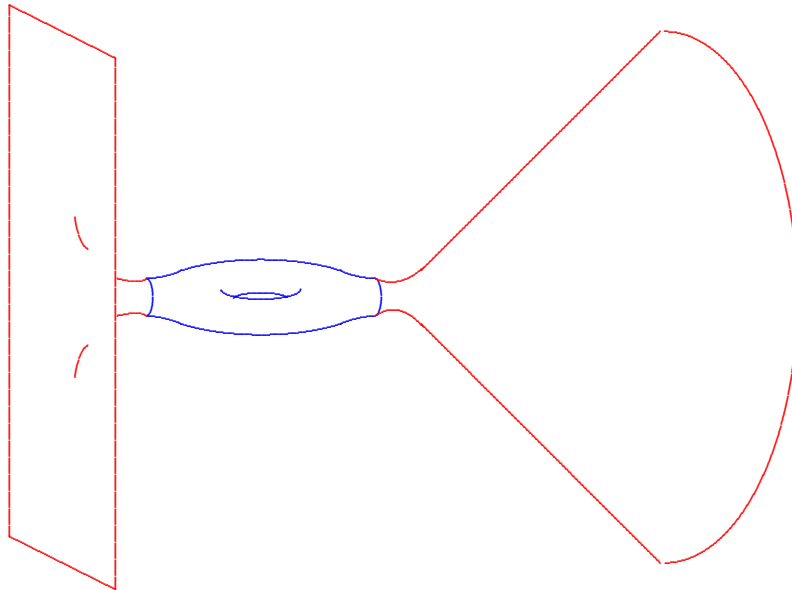

Definition. Complete, non-compact n -manifold (M^n, g) is asymptotically locally Euclidean (ALE) if \exists compact set $K \subset M$ such that $M - K \approx \coprod_i (\mathbb{R}^n - D^n) / \Gamma_i$,

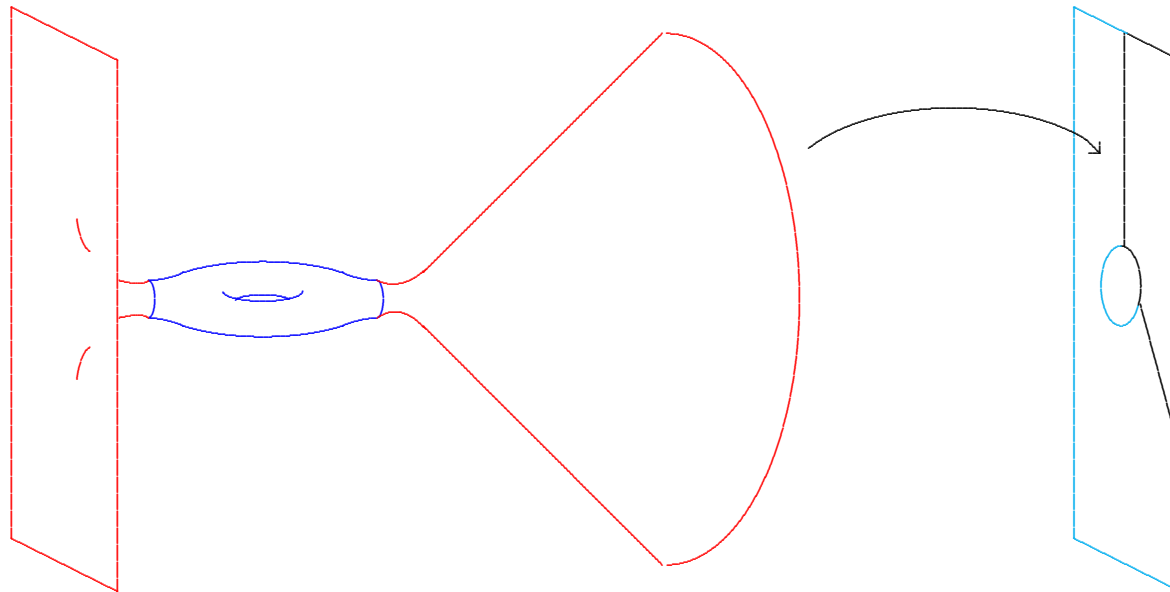

Definition. Complete, non-compact n -manifold (M^n, g) is asymptotically locally Euclidean (ALE) if \exists compact set $K \subset M$ such that $M - K \approx \coprod_i (\mathbb{R}^n - D^n) / \Gamma_i$, where $\Gamma_i \subset \mathbf{O}(n)$,

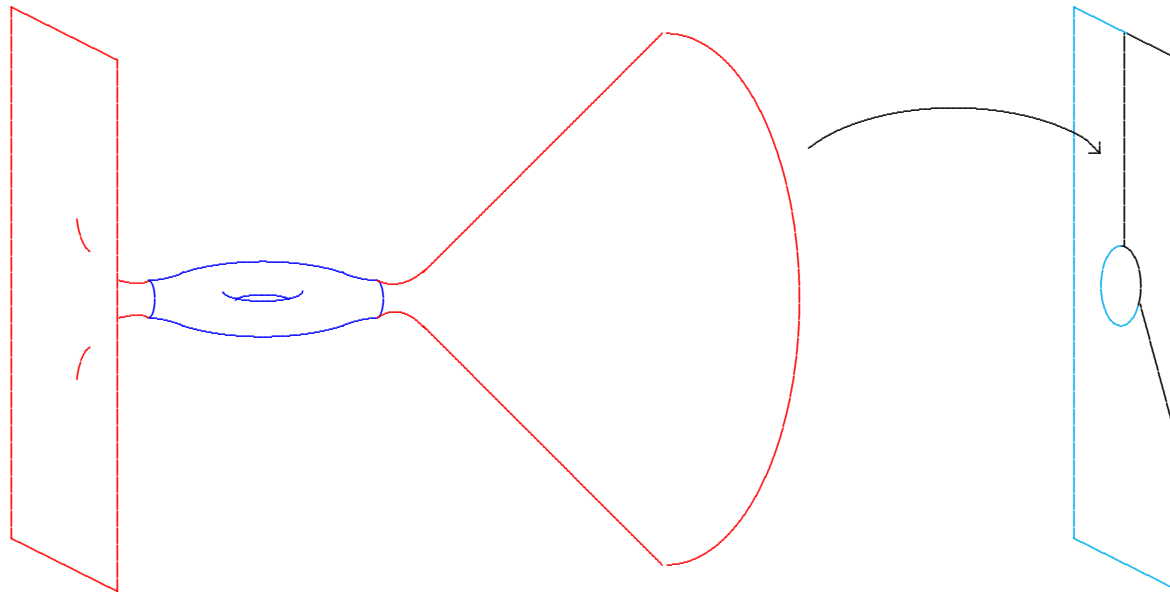

Definition. Complete, non-compact n -manifold (M^n, g) is asymptotically locally Euclidean (ALE) if \exists compact set $K \subset M$ such that $M - K \approx \coprod_i (\mathbb{R}^n - D^n) / \Gamma_i$, where $\Gamma_i \subset \mathbf{O}(n)$,

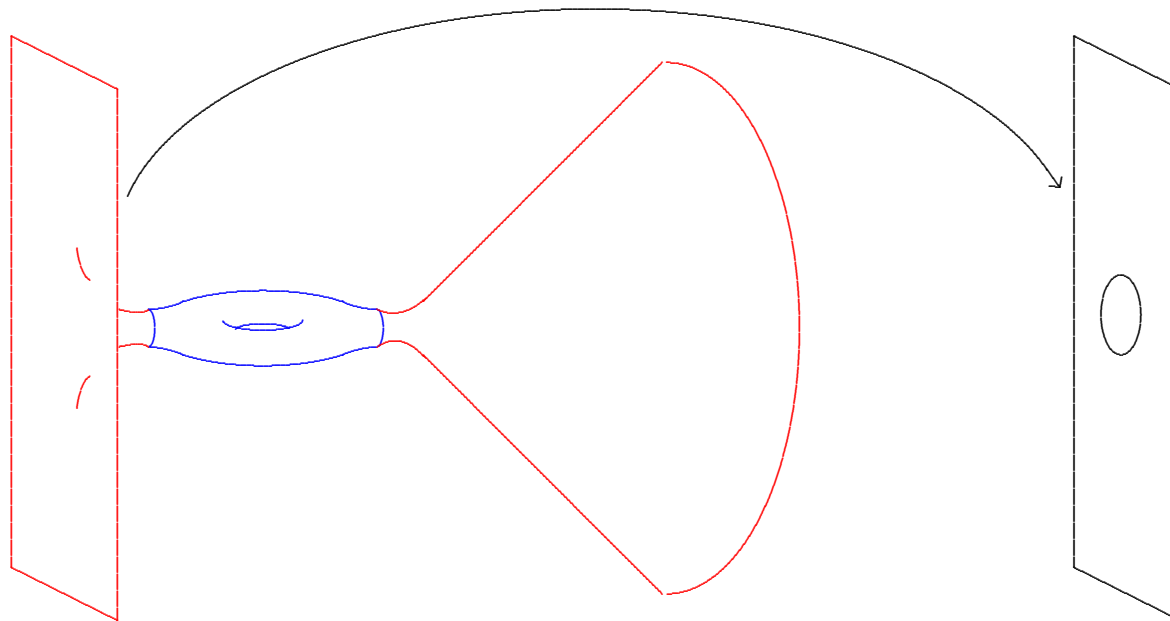

Definition. Complete, non-compact n -manifold (M^n, g) is asymptotically locally Euclidean (ALE) if \exists compact set $K \subset M$ such that $M - K \approx \coprod_i (\mathbb{R}^n - D^n) / \Gamma_i$, where $\Gamma_i \subset \mathbf{O}(n)$,

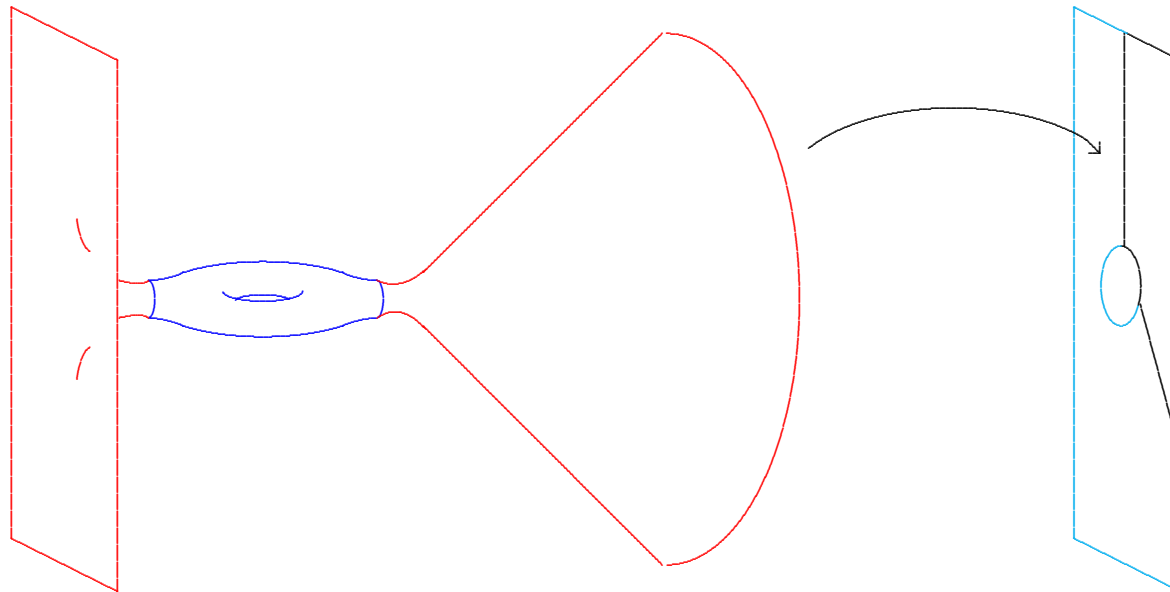

Definition. Complete, non-compact n -manifold (M^n, g) is asymptotically locally Euclidean (ALE) if \exists compact set $K \subset M$ such that $M - K \approx \coprod_i (\mathbb{R}^n - D^n) / \Gamma_i$, where $\Gamma_i \subset \mathbf{O}(n)$, such that

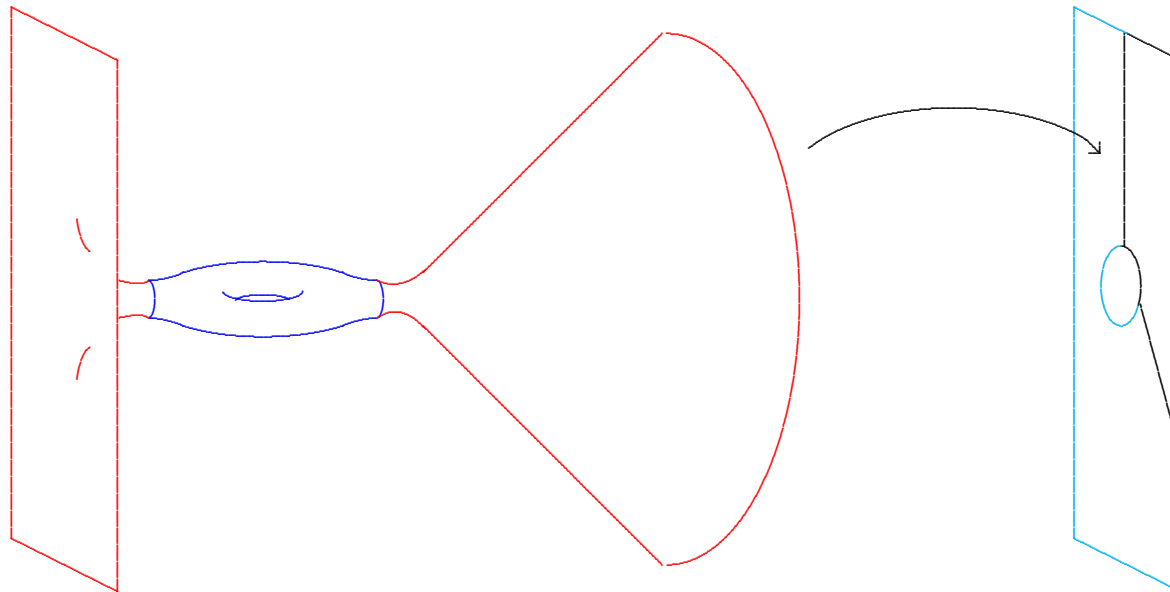

$$g_{jk} = \delta_{jk} + O(|x|^{1-\frac{n}{2}-\varepsilon})$$

$$g_{jk,\ell} = O(|x|^{-\frac{n}{2}-\varepsilon}), \quad s \in L^1$$

Why consider *ALE* spaces?

Key examples:

Key examples:

Term **ALE** coined by Gibbons & Hawking, 1979.

Key examples:

Term **ALE** coined by Gibbons & Hawking, 1979.

They wrote down various explicit **Ricci-flat ALE** 4-manifolds they called **gravitational instantons**.

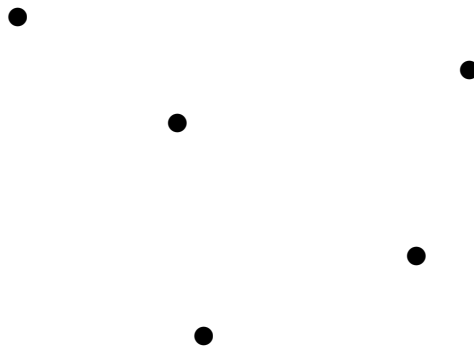

Data: ℓ points in \mathbb{R}^3 .

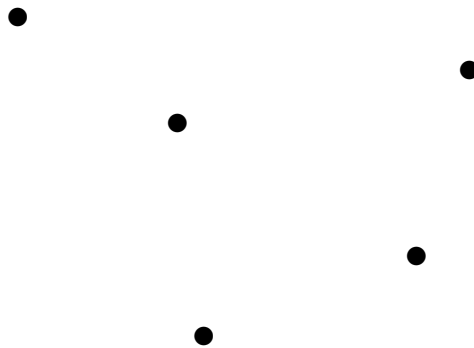

Data: ℓ points in \mathbb{R}^3 . $\implies V$ with $\Delta V = 0$

$$V = \sum_{j=1}^{\ell} \frac{1}{2^{\rho_j}}$$

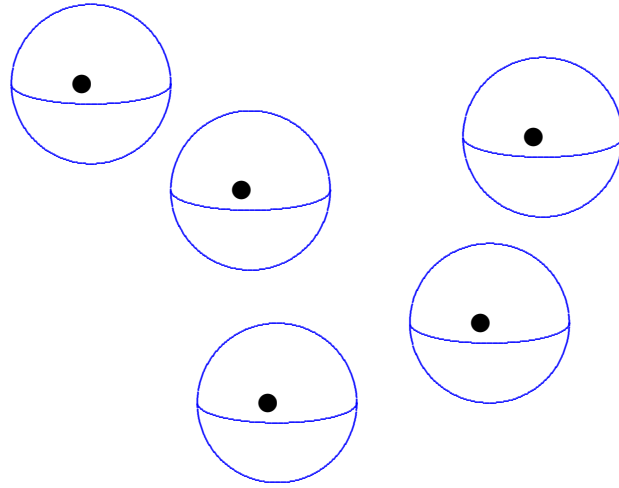

Data: ℓ points in \mathbb{R}^3 . $\implies V$ with $\Delta V = 0$

$$V = \sum_{j=1}^{\ell} \frac{1}{2^{\rho_j}}$$

$F = \star dV$ curvature θ on $P \rightarrow \mathbb{R}^3 - \{\text{pts}\}$.

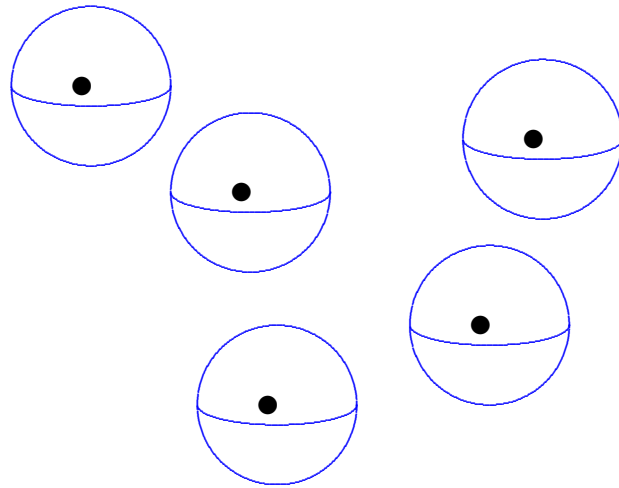

Data: ℓ points in \mathbb{R}^3 . $\implies V$ with $\Delta V = 0$

$$g = Vh + V^{-1}\theta^2$$

$F = \star dV$ curvature θ on $P \rightarrow \mathbb{R}^3 - \{\text{pts}\}$.

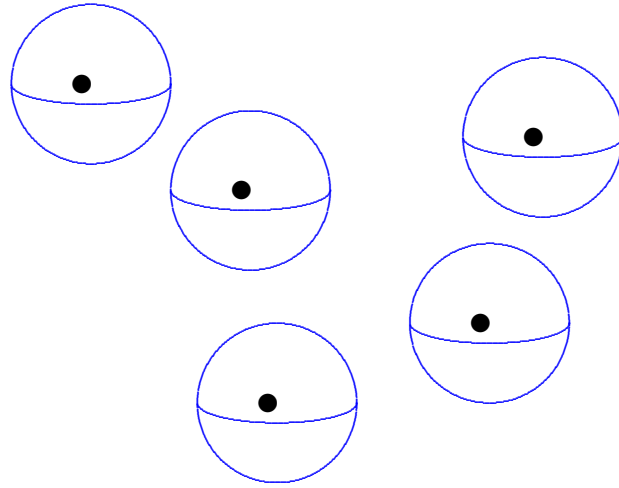

Data: ℓ points in \mathbb{R}^3 . $\implies V$ with $\Delta V = 0$

$$g = V(dx^2 + dy^2 + dz^2) + V^{-1}\theta^2$$

$F = \star dV$ curvature θ on $P \rightarrow \mathbb{R}^3 - \{\text{pts}\}$.

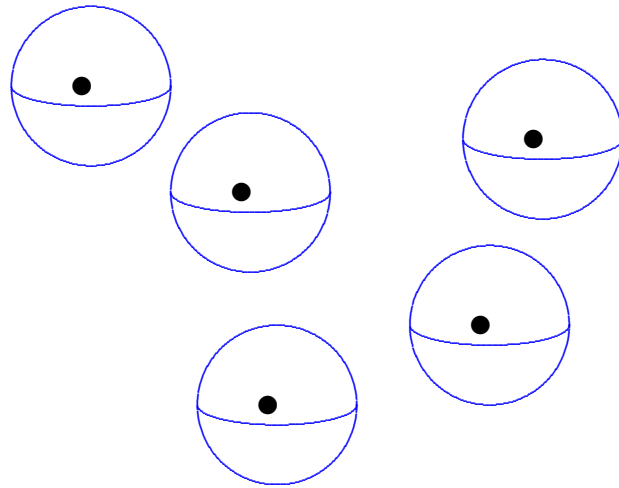

Data: ℓ points in \mathbb{R}^3 . $\implies V$ with $\Delta V = 0$

$$g = Vh + V^{-1}\theta^2$$

$F = \star dV$ curvature θ on $P \rightarrow \mathbb{R}^3 - \{\text{pts}\}$.

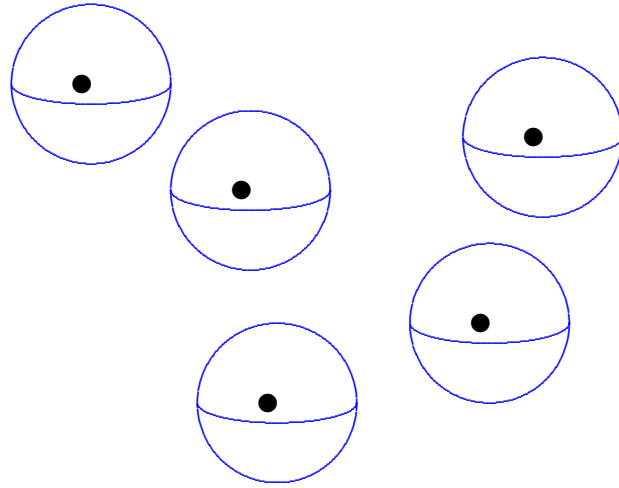

Data: ℓ points in \mathbb{R}^3 . $\implies V$ with $\Delta V = 0$

$$g = Vh + V^{-1}\theta^2$$

on P . Then take $M^4 =$ Riemannian completion.

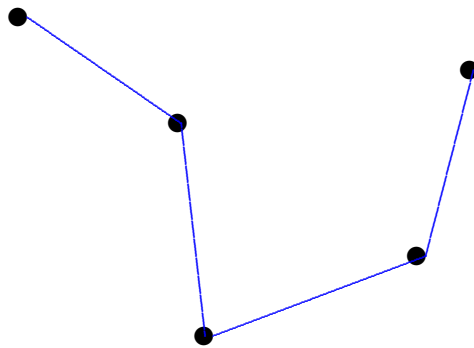

Data: ℓ points in \mathbb{R}^3 . $\implies V$ with $\Delta V = 0$

$$g = Vh + V^{-1}\theta^2$$

on P . Then take $M^4 =$ Riemannian completion.

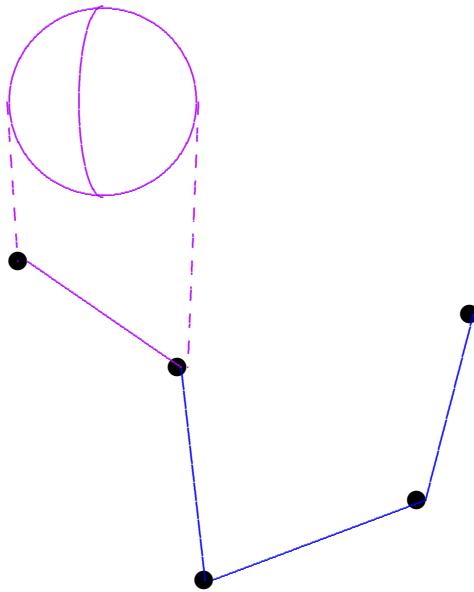

Data: ℓ points in \mathbb{R}^3 . $\implies V$ with $\Delta V = 0$

$$g = Vh + V^{-1}\theta^2$$

on P . Then take $M^4 =$ Riemannian completion.

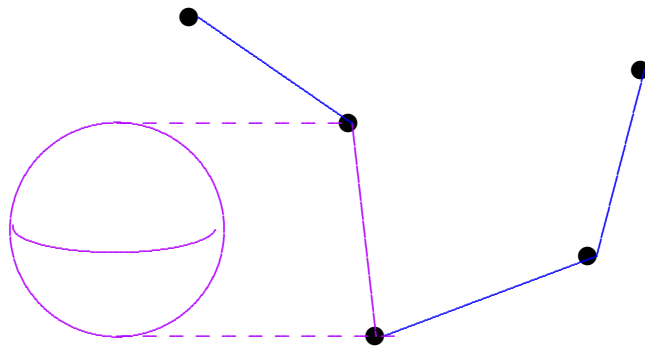

Data: ℓ points in \mathbb{R}^3 . $\implies V$ with $\Delta V = 0$

$$g = Vh + V^{-1}\theta^2$$

on P . Then take $M^4 =$ Riemannian completion.

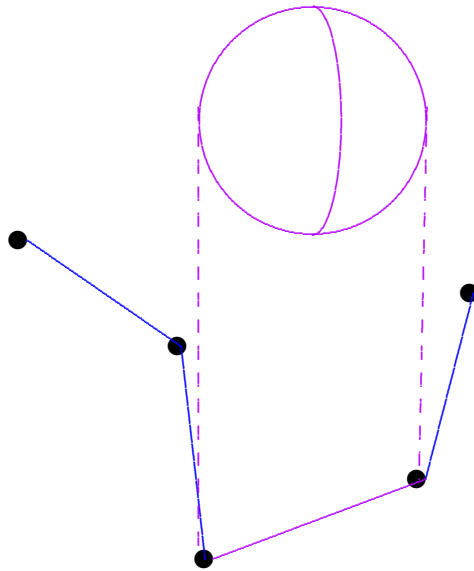

Data: ℓ points in \mathbb{R}^3 . $\implies V$ with $\Delta V = 0$

$$g = Vh + V^{-1}\theta^2$$

on P . Then take $M^4 =$ Riemannian completion.

Deform retracts to $k = \ell - 1$ copies of S^2 ,

Deform retracts to $k = \ell - 1$ copies of S^2 ,
each with self-intersection -2 ,

Deform retracts to $k = \ell - 1$ copies of S^2 ,
each with self-intersection -2 ,
meeting transversely, & forming connected set:

Deform retracts to $k = \ell - 1$ copies of S^2 ,
each with self-intersection -2 ,
meeting transversely, & forming connected set:

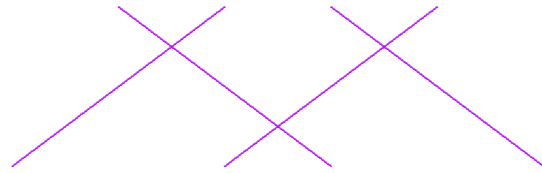

Deform retracts to $k = \ell - 1$ copies of S^2 ,
each with self-intersection -2 ,
meeting transversely, & forming connected set:

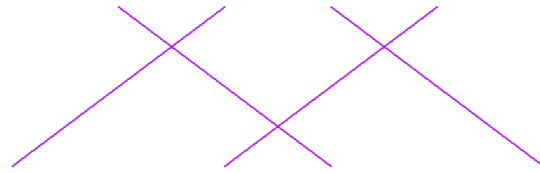

Configuration dual to Dynkin diagram A_k :

Deform retracts to $k = \ell - 1$ copies of S^2 ,
each with self-intersection -2 ,
meeting transversely, & forming connected set:

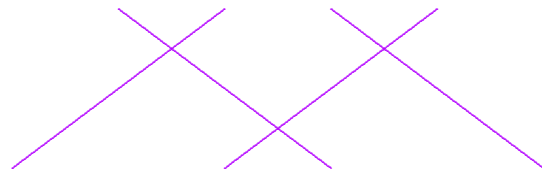

Configuration dual to Dynkin diagram A_k :



Deform retracts to $k = \ell - 1$ copies of S^2 ,
each with self-intersection -2 ,
meeting transversely, & forming connected set:

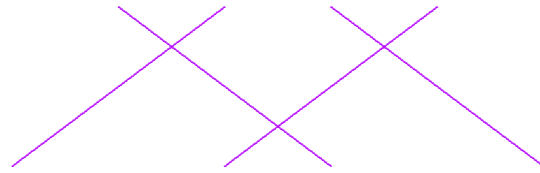

Configuration dual to Dynkin diagram A_k :



Diffeotype:

Deform retracts to $k = \ell - 1$ copies of S^2 ,
each with self-intersection -2 ,
meeting transversely, & forming connected set:

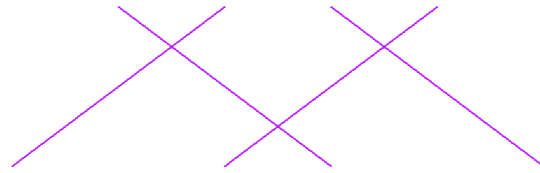

Configuration dual to Dynkin diagram A_k :



Diffeotype:

Plumb together k copies of T^*S^2
according to diagram.

Key examples:

Term **ALE** coined by Gibbons & Hawking, 1979.

They wrote down various explicit **Ricci-flat ALE** 4-manifolds they called **gravitational instantons**.

Key examples:

Term **ALE** coined by Gibbons & Hawking, 1979.

They wrote down various explicit **Ricci-flat ALE** 4-manifolds they called **gravitational instantons**.

Their examples have just one end, with

$$\Gamma \cong \mathbb{Z}_\ell \subset \mathbf{SU}(2) \subset \mathbf{O}(4).$$

Key examples:

Term **ALE** coined by Gibbons & Hawking, 1979.

They wrote down various explicit **Ricci-flat ALE** 4-manifolds they called **gravitational instantons**.

Their examples have just one end, with

$$\Gamma \cong \mathbb{Z}_\ell \subset \mathbf{SU}(2) \subset \mathbf{O}(4).$$

The G-H metrics are **hyper-Kähler**, and were soon independently rediscovered by Hitchin.

(M^n, g) :

holonomy

$(M^n, g):$

holonomy

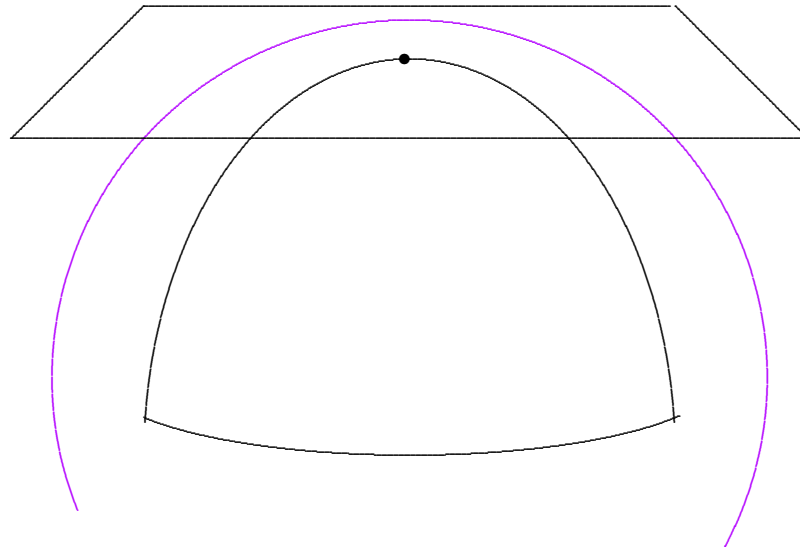

(M^n, g) :

holonomy

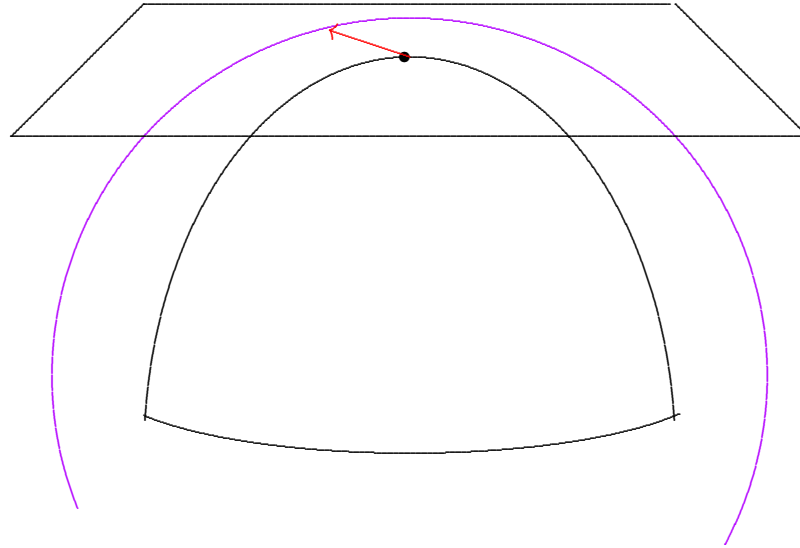

(M^n, g) :

holonomy

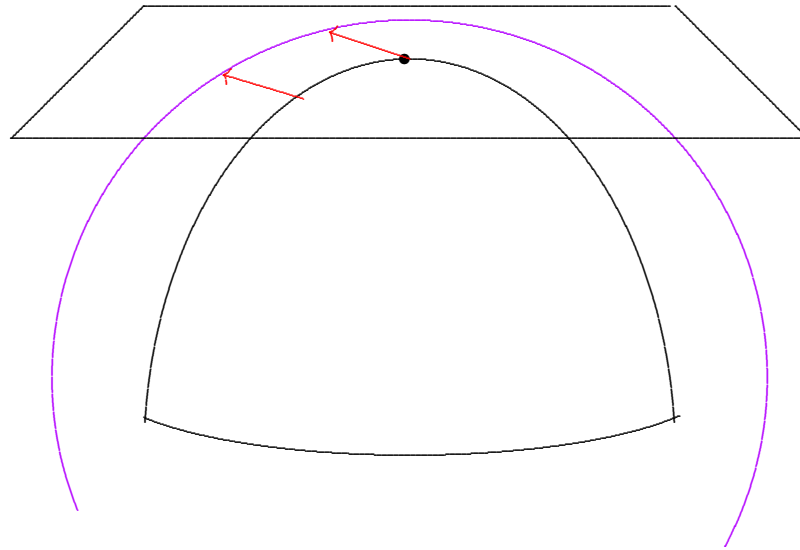

(M^n, g) :

holonomy

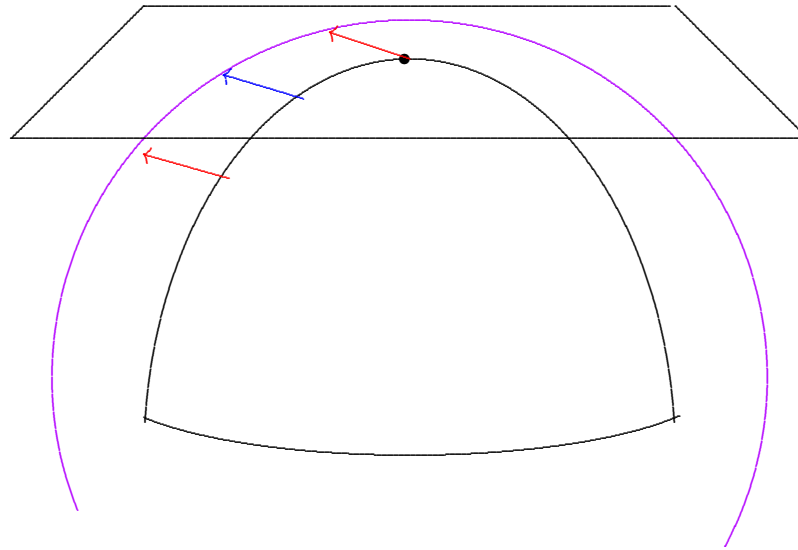

(M^n, g) :

holonomy

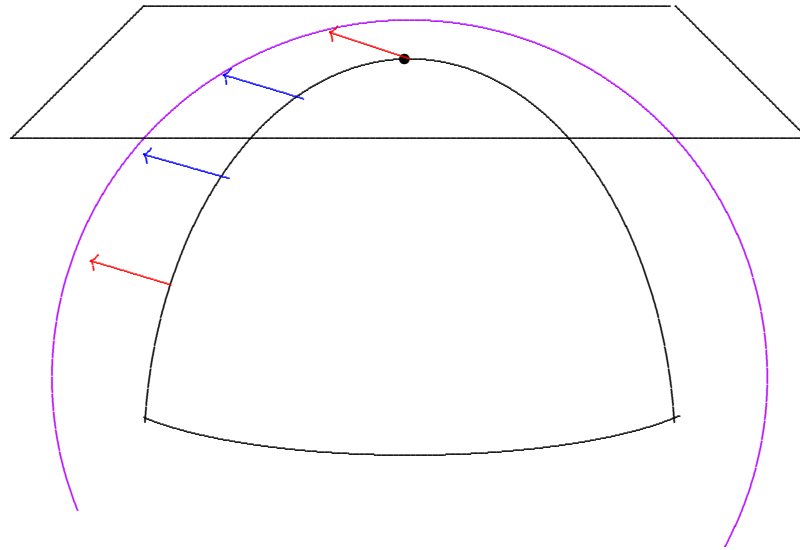

(M^n, g) :

holonomy

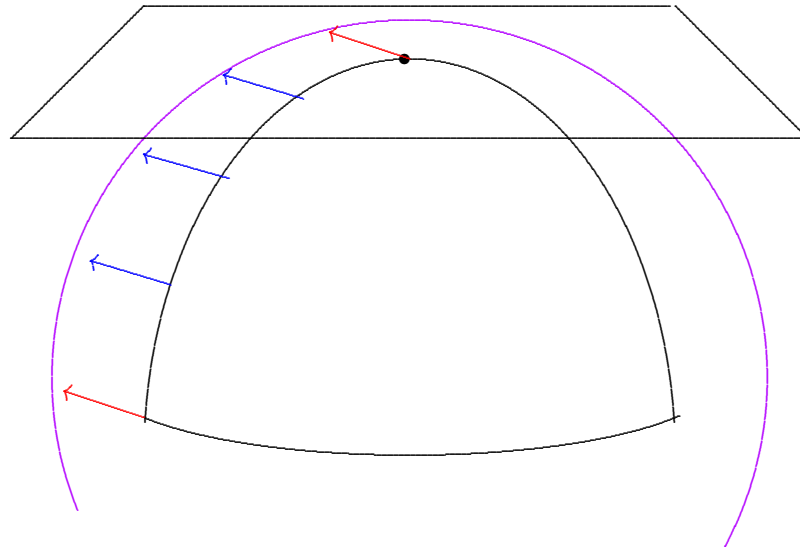

(M^n, g) :

holonomy

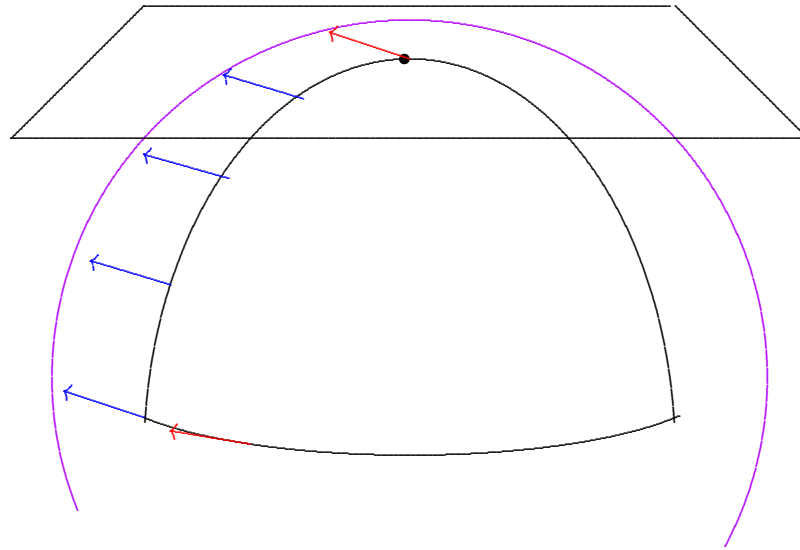

(M^n, g) :

holonomy

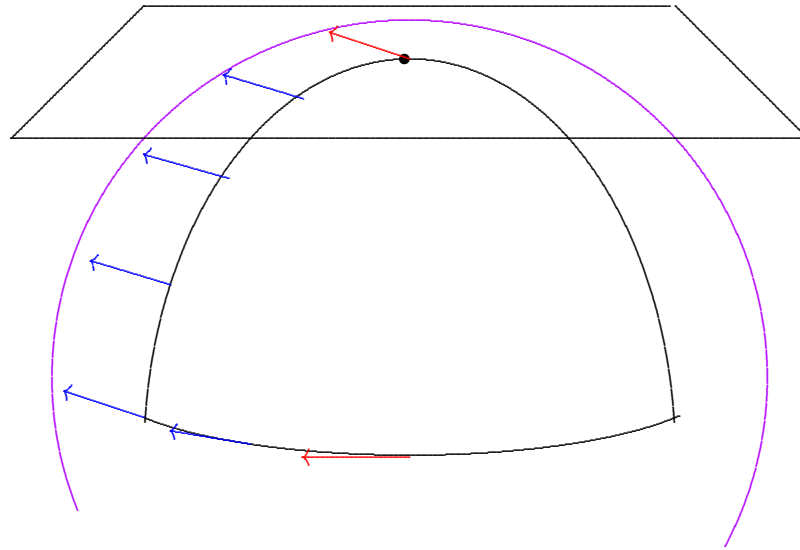

(M^n, g) :

holonomy

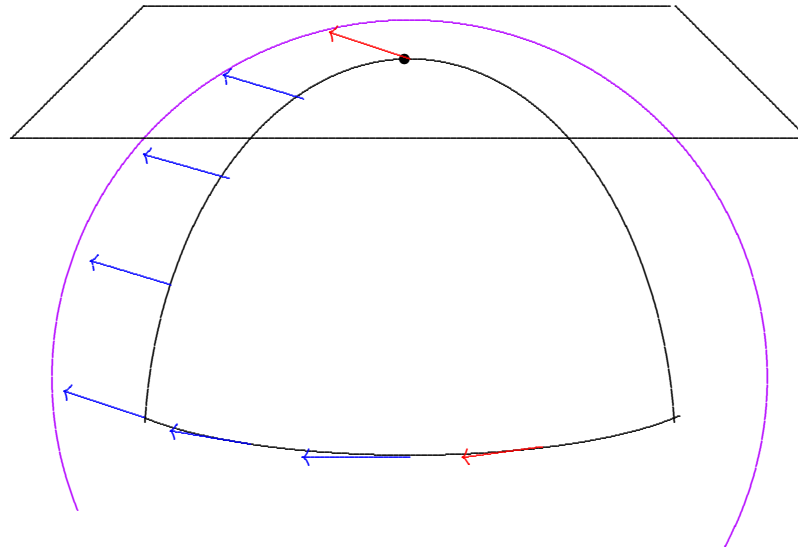

(M^n, g) :

holonomy

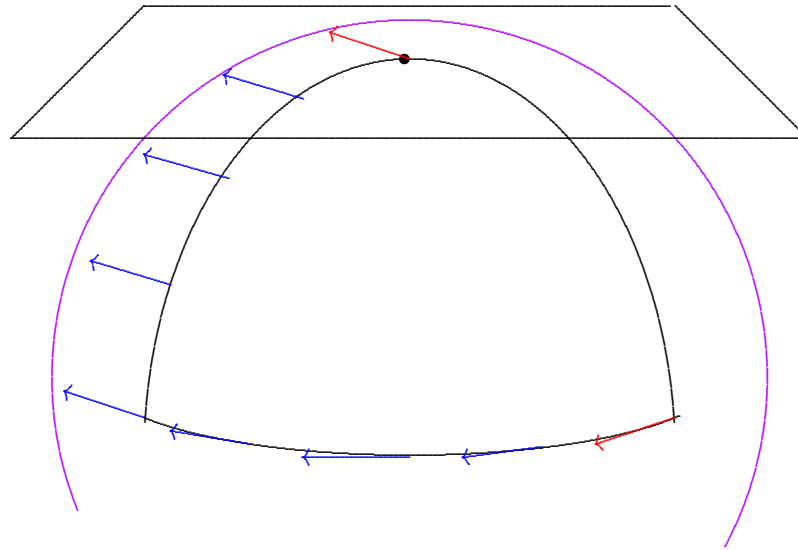

(M^n, g) :

holonomy

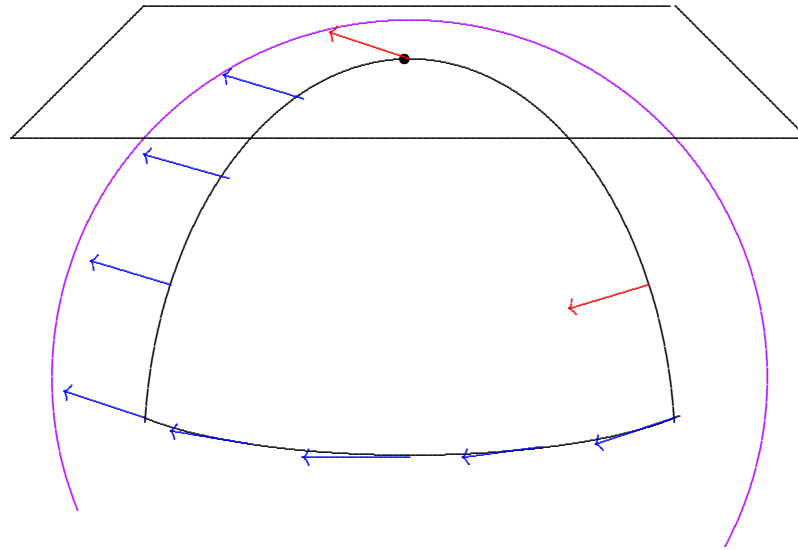

(M^n, g) :

holonomy

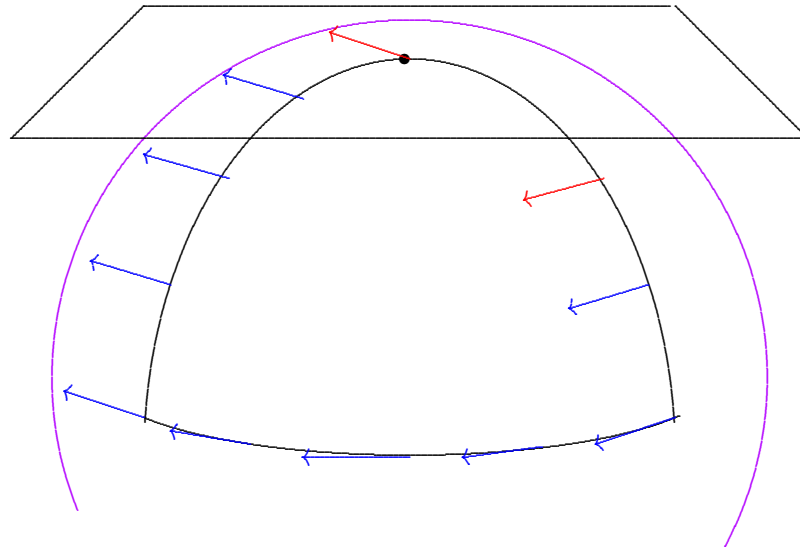

(M^n, g) :

holonomy

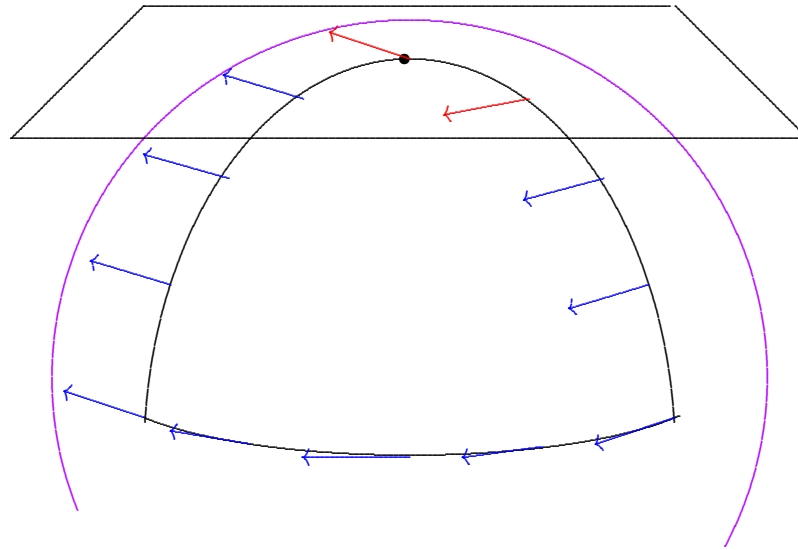

(M^n, g) :

holonomy

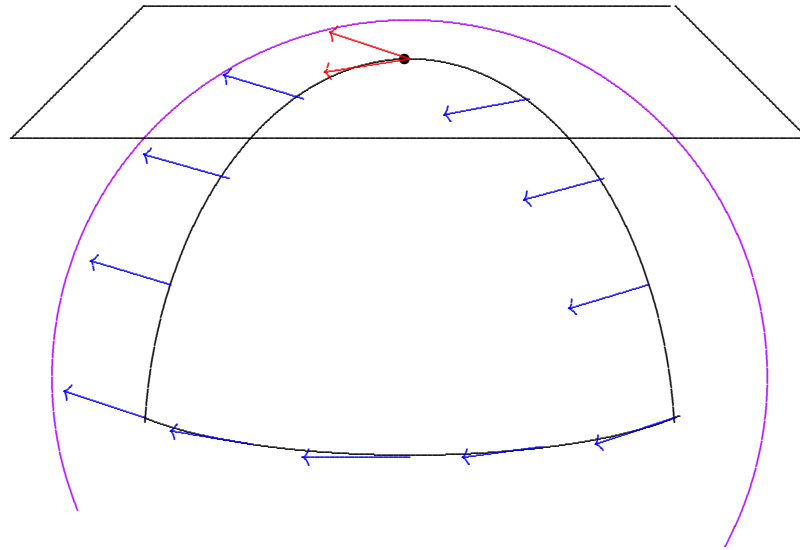

(M^n, g) :

holonomy

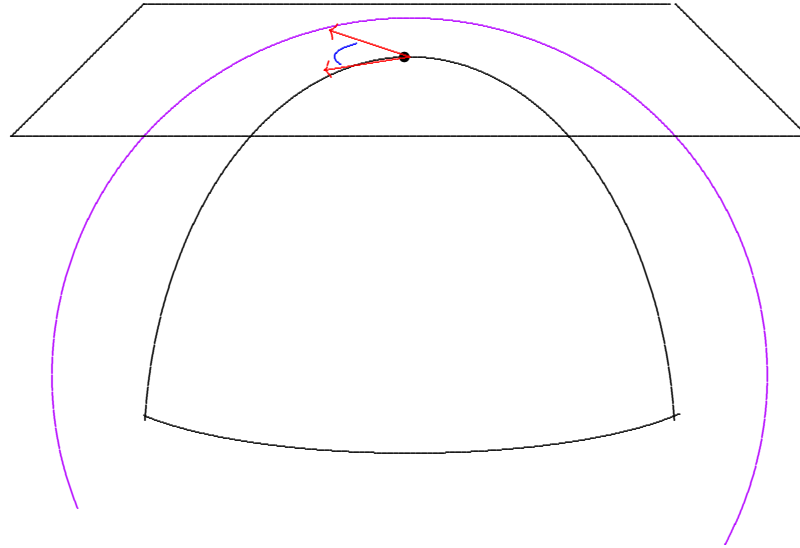

(M^n, g) :

holonomy $\subset \mathbf{O}(n)$

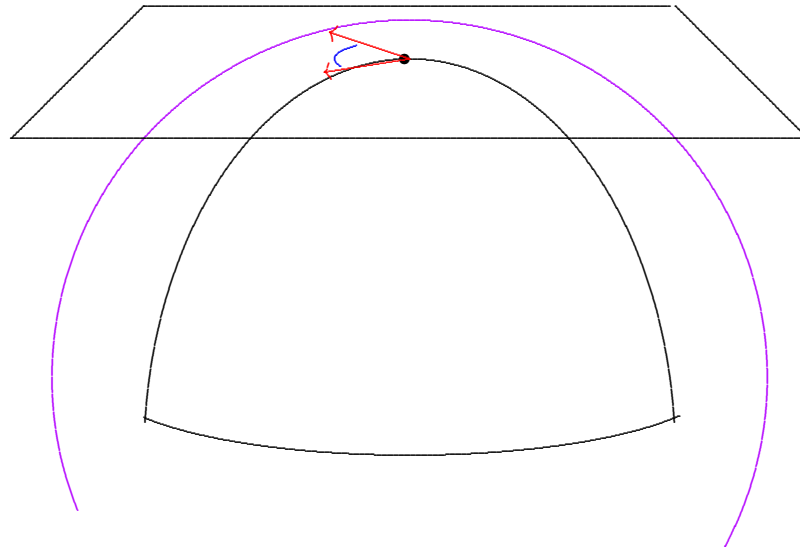

Kähler metrics:

(M^{2m}, g) :

holonomy

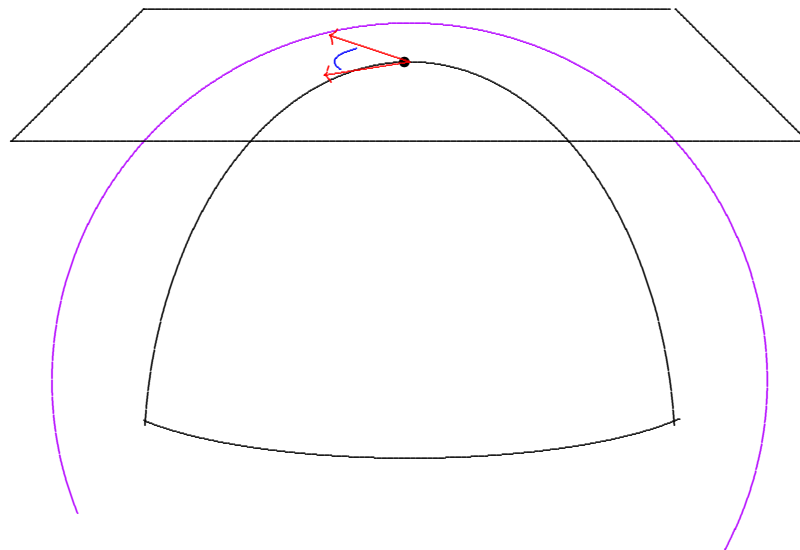

Kähler metrics:

(M^{2m}, g) Kähler \iff holonomy $\subset \mathbf{U}(m)$

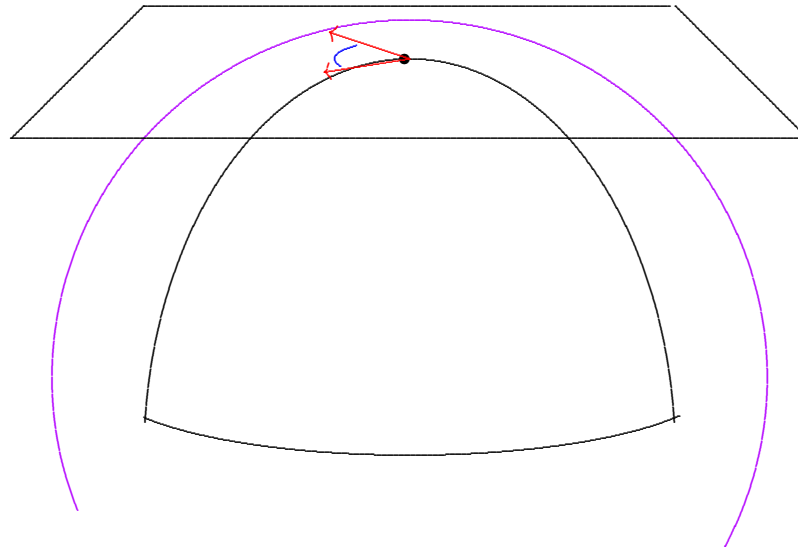

Kähler metrics:

(M^{2m}, g) Kähler \iff holonomy $\subset \mathbf{U}(m)$

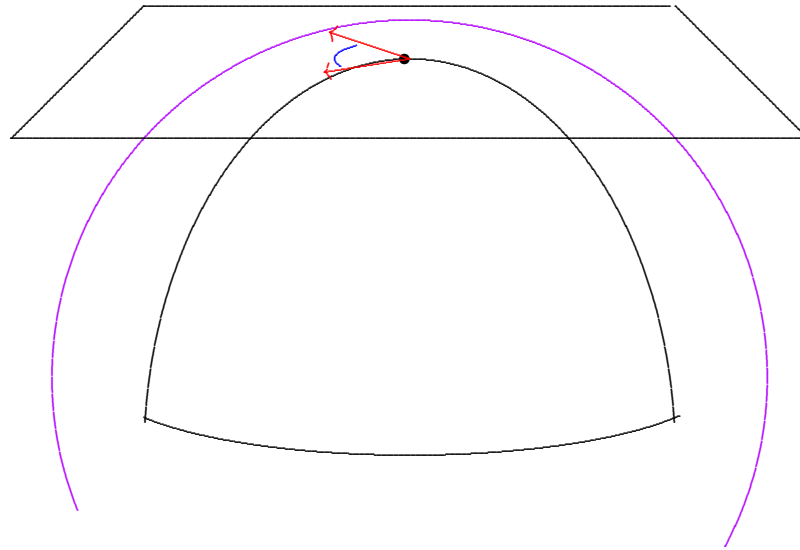

$$\mathbf{U}(m) := \mathbf{O}(2m) \cap \mathbf{GL}(m, \mathbb{C})$$

Kähler metrics:

(M^{2m}, g) Kähler \iff holonomy $\subset \mathbf{U}(m)$

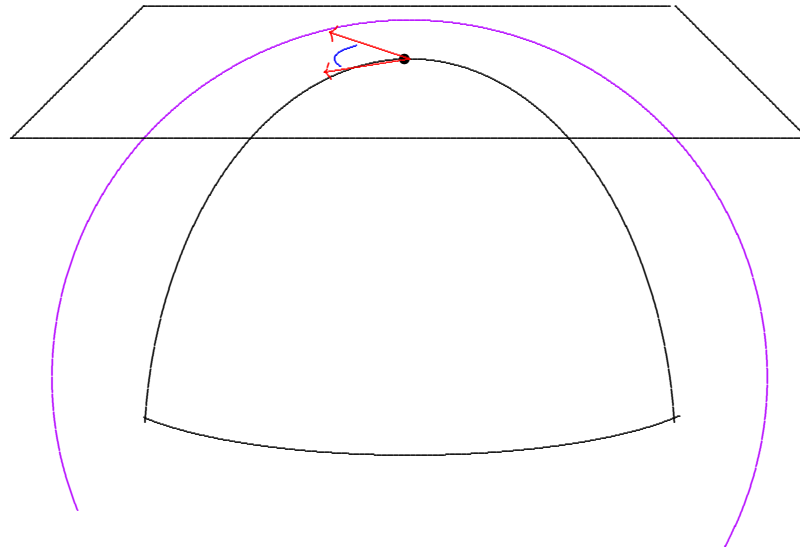

Makes tangent space a complex vector space!

Kähler metrics:

(M^{2m}, g) Kähler \iff holonomy $\subset \mathbf{U}(m)$

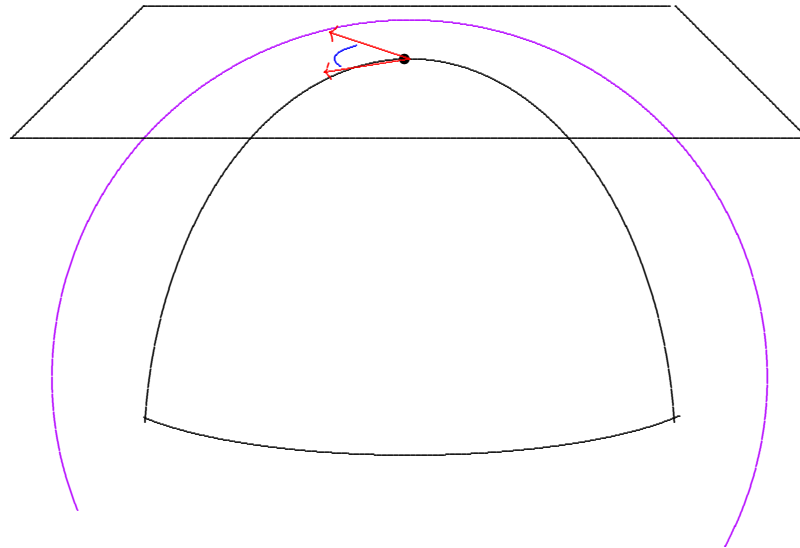

Makes tangent space a complex vector space!

$$J : TM \rightarrow TM, \quad J^2 = -\text{identity}$$

“almost-complex structure”

Kähler metrics:

(M^{2m}, g) Kähler \iff holonomy $\subset \mathbf{U}(m)$

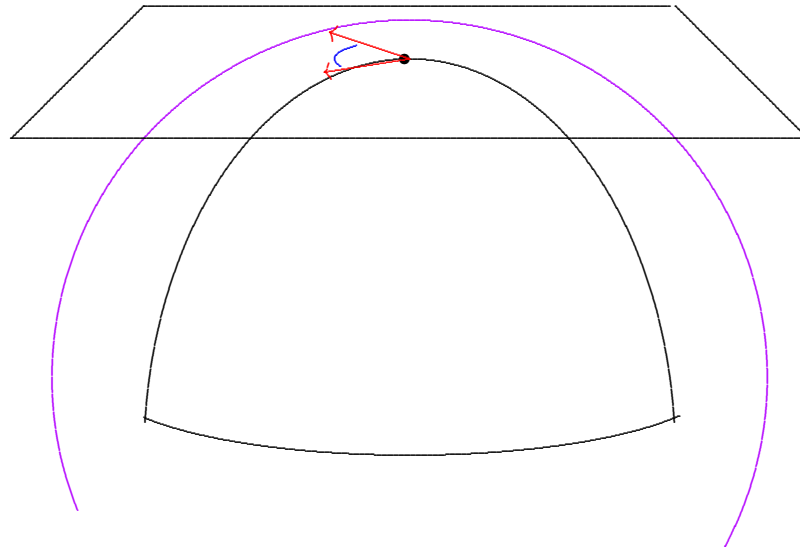

Makes tangent space a complex vector space!

Invariant under parallel transport!

Kähler metrics:

(M^{2m}, g) Kähler \iff holonomy $\subset \mathbf{U}(m)$

$\iff \exists$ almost complex-structure J with $\nabla J = 0$
and $g(J\cdot, J\cdot) = g$.

Kähler metrics:

(M^{2m}, g) Kähler \iff holonomy $\subset \mathbf{U}(m)$

$\iff \exists$ almost complex-structure J with $\nabla J = 0$
and $g(J\cdot, J\cdot) = g$.

$\iff (M^{2m}, g)$ is a complex manifold & $\exists J$ -invariant
closed 2-form ω such that $g = \omega(\cdot, J\cdot)$.

Kähler metrics:

(M^{2m}, g) Kähler \iff holonomy $\subset \mathbf{U}(m)$

$\iff \exists$ almost complex-structure J with $\nabla J = 0$
and $g(J\cdot, J\cdot) = g$.

$\iff (M^{2m}, g)$ is a complex manifold & $\exists J$ -invariant
closed 2-form ω such that $g = \omega(\cdot, J\cdot)$.

$$d\omega = 0$$

Kähler metrics:

(M^{2m}, g) Kähler \iff holonomy $\subset \mathbf{U}(m)$

$\iff \exists$ almost complex-structure J with $\nabla J = 0$
and $g(J\cdot, J\cdot) = g$.

$\iff (M^{2m}, g)$ is a complex manifold & $\exists J$ -invariant
closed 2-form ω such that $g = \omega(\cdot, J\cdot)$.

$$[\omega] \in H^2(M)$$

“Kähler class”

Kähler metrics:

(M^{2m}, g) Kähler \iff holonomy $\subset \mathbf{U}(m)$

$\iff \exists$ almost complex-structure J with $\nabla J = 0$
and $g(J\cdot, J\cdot) = g$.

$\iff (M^{2m}, g)$ is a complex manifold & $\exists J$ -invariant
closed 2-form ω such that $g = \omega(\cdot, J\cdot)$.

Kähler metrics:

(M^{2m}, g) Kähler \iff holonomy $\subset \mathbf{U}(m)$

$\iff \exists$ almost complex-structure J with $\nabla J = 0$
and $g(J\cdot, J\cdot) = g$.

$\iff (M^{2m}, g)$ is a complex manifold & $\exists J$ -invariant
closed 2-form ω such that $g = \omega(\cdot, J\cdot)$.

\iff In local complex coordinates (z^1, \dots, z^m) ,

$$g = - \sum_{j,k=1}^m \frac{\partial^2 f}{\partial z^j \partial \bar{z}^k} \left[dz^j \otimes d\bar{z}^k + d\bar{z}^k \otimes dz^j \right]$$

Kähler metrics:

(M^{2m}, g) Kähler \iff holonomy $\subset \mathbf{U}(m)$

$\iff \exists$ almost complex-structure J with $\nabla J = 0$
and $g(J\cdot, J\cdot) = g$.

$\iff (M^{2m}, g)$ is a complex manifold & $\exists J$ -invariant
closed 2-form ω such that $g = \omega(\cdot, J\cdot)$.

\iff In local complex coordinates (z^1, \dots, z^m) , $\exists f(z)$

$$g = - \sum_{j,k=1}^m \frac{\partial^2 f}{\partial z^j \partial \bar{z}^k} \left[dz^j \otimes d\bar{z}^k + d\bar{z}^k \otimes dz^j \right]$$

Kähler metrics:

(M^{2m}, g) Kähler \iff holonomy $\subset \mathbf{U}(m)$

$\iff \exists$ almost complex-structure J with $\nabla J = 0$
and $g(J\cdot, J\cdot) = g$.

$\iff (M^{2m}, g)$ is a complex manifold & $\exists J$ -invariant
closed 2-form ω such that $g = \omega(\cdot, J\cdot)$.

\iff In local complex coordinates (z^1, \dots, z^m) , $\exists f(z)$

$$\omega = i \sum_{j,k=1}^m \frac{\partial^2 f}{\partial z^j \partial \bar{z}^k} dz^j \wedge d\bar{z}^k$$

Kähler metrics:

(M^{2m}, g) Kähler \iff holonomy $\subset \mathbf{U}(m)$

$\iff \exists$ almost complex-structure J with $\nabla J = 0$
and $g(J\cdot, J\cdot) = g$.

$\iff (M^{2m}, g)$ is a complex manifold & $\exists J$ -invariant
closed 2-form ω such that $g = \omega(\cdot, J\cdot)$.

\iff In local complex coordinates (z^1, \dots, z^m) , $\exists f(z)$

$$g = - \sum_{j,k=1}^m \frac{\partial^2 f}{\partial z^j \partial \bar{z}^k} \left[dz^j \otimes d\bar{z}^k + d\bar{z}^k \otimes dz^j \right]$$

Kähler metrics:

(M^{2m}, g) Kähler \iff holonomy $\subset \mathbf{U}(m)$

$\iff \exists$ almost complex-structure J with $\nabla J = 0$
and $g(J\cdot, J\cdot) = g$.

$\iff (M^{2m}, g)$ is a complex manifold & $\exists J$ -invariant
closed 2-form ω such that $g = \omega(\cdot, J\cdot)$.

Kähler magic:

$$r = - \sum_{j,k=1}^m \frac{\partial^2}{\partial z^j \partial \bar{z}^k} \log \det[g_{p\bar{q}}] \left[dz^j \otimes d\bar{z}^k + d\bar{z}^k \otimes dz^j \right]$$

Kähler metrics:

(M^{2m}, g) Kähler \iff holonomy $\subset \mathbf{U}(m)$

$\iff \exists$ almost complex-structure J with $\nabla J = 0$
and $g(J\cdot, J\cdot) = g$.

$\iff (M^{2m}, g)$ is a complex manifold & $\exists J$ -invariant
closed 2-form ω such that $g = \omega(\cdot, J\cdot)$.

Kähler magic:

If we define the Ricci form by

$$\rho = r(J\cdot, \cdot)$$

then $i\rho$ is curvature of canonical line bundle $\Lambda^{m,0}$.

Kähler metrics:

(M^{2m}, g) :

holonomy

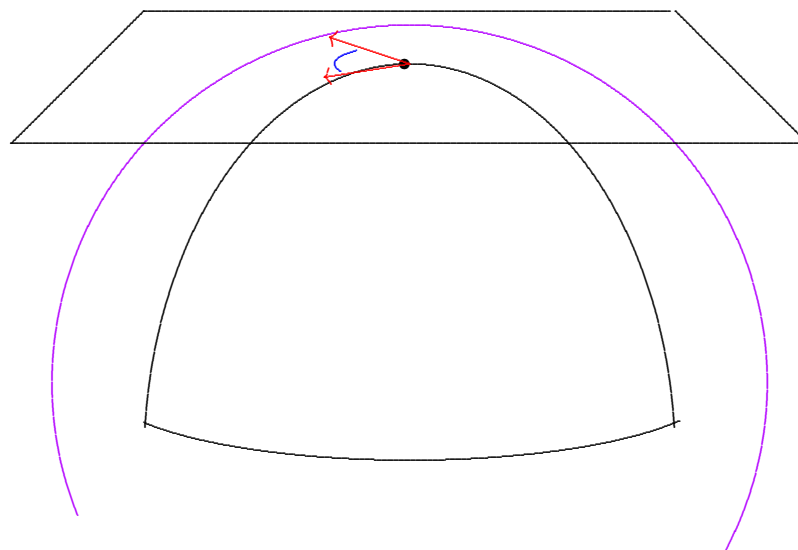

Kähler metrics:

(M^{2m}, g) : Ricci-flat Kähler \iff holonomy $\subset \mathbf{SU}(m)$

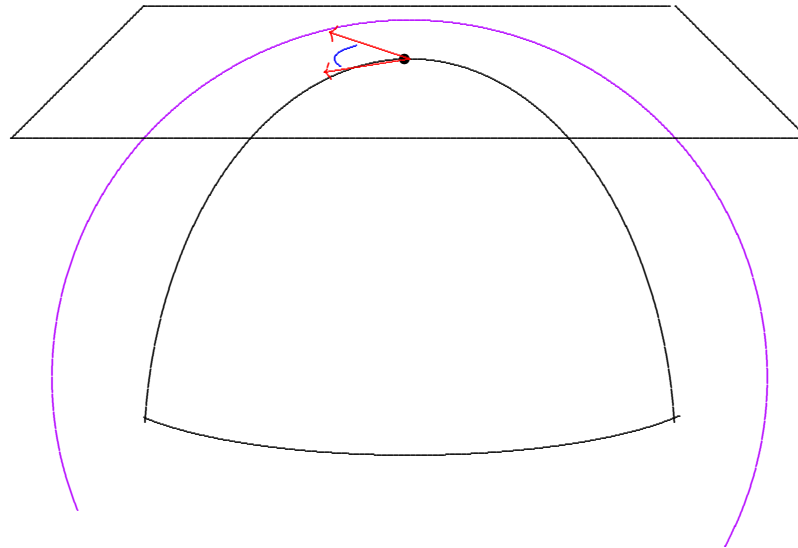

Kähler metrics:

(M^{2m}, g) : Ricci-flat Kähler \iff holonomy $\subset \mathbf{SU}(m)$

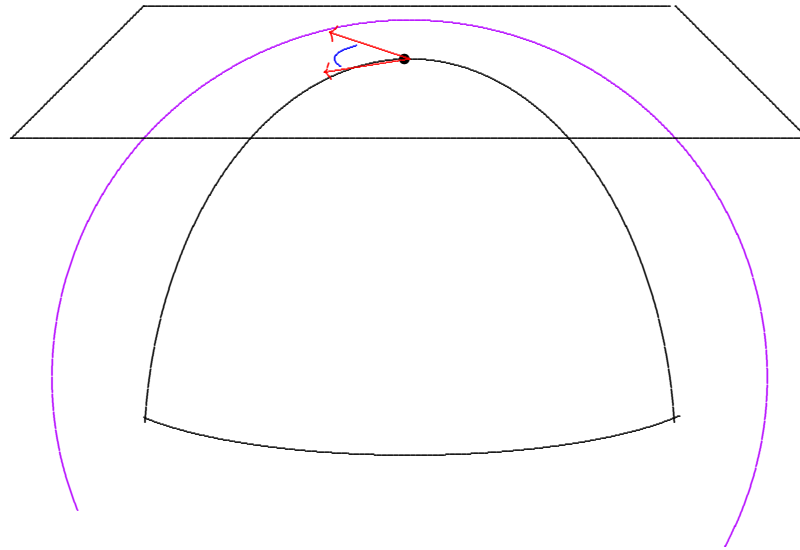

$$\mathbf{SU}(m) \subset \mathbf{U}(m) : \quad \{A \mid \det A = 1\}$$

Kähler metrics:

(M^{2m}, g) : Ricci-flat Kähler \iff holonomy $\subset \mathbf{SU}(m)$

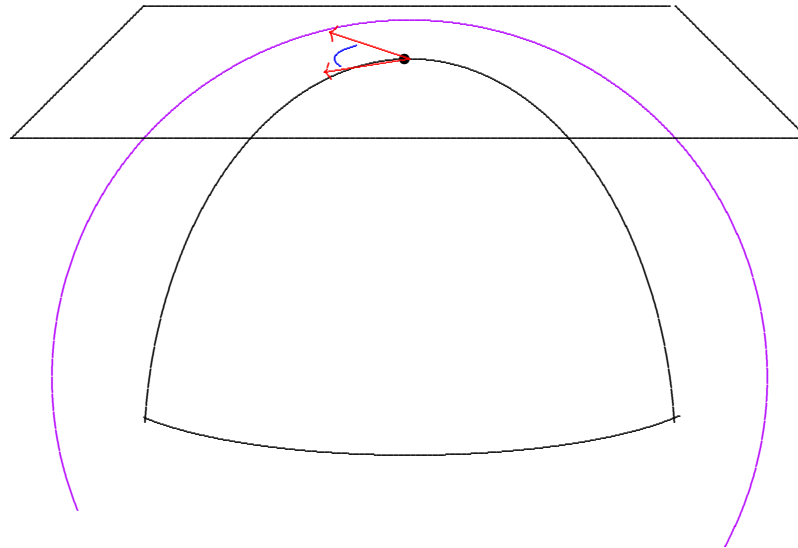

Kähler metrics:

(M^{2m}, g) : Ricci-flat Kähler \iff holonomy $\subset \mathbf{SU}(m)$

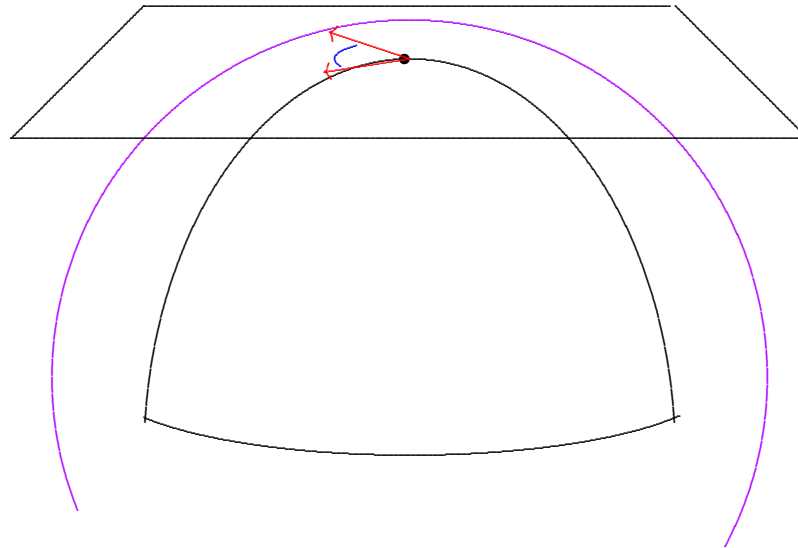

if M is simply connected.

Hyper-Kähler metrics:

$(M^{4\ell}, g)$

holonomy

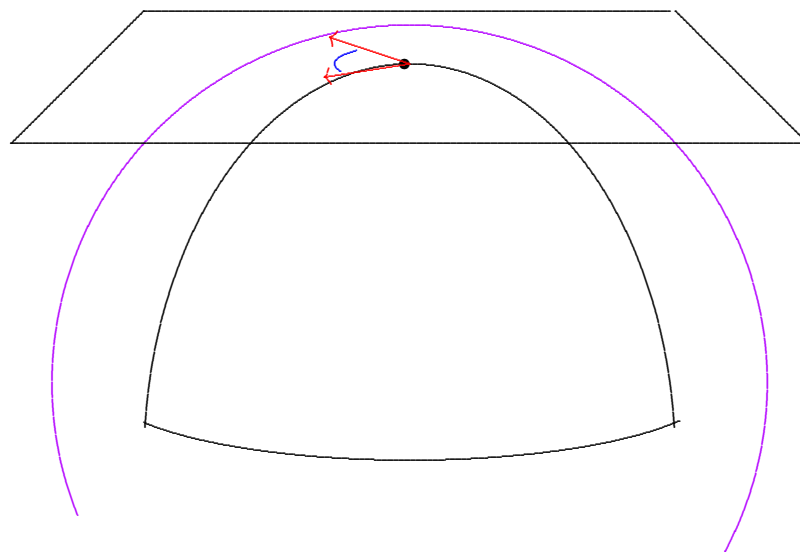

Hyper-Kähler metrics:

$(M^{4\ell}, g)$ hyper-Kähler \iff holonomy $\subset \mathbf{Sp}(\ell)$

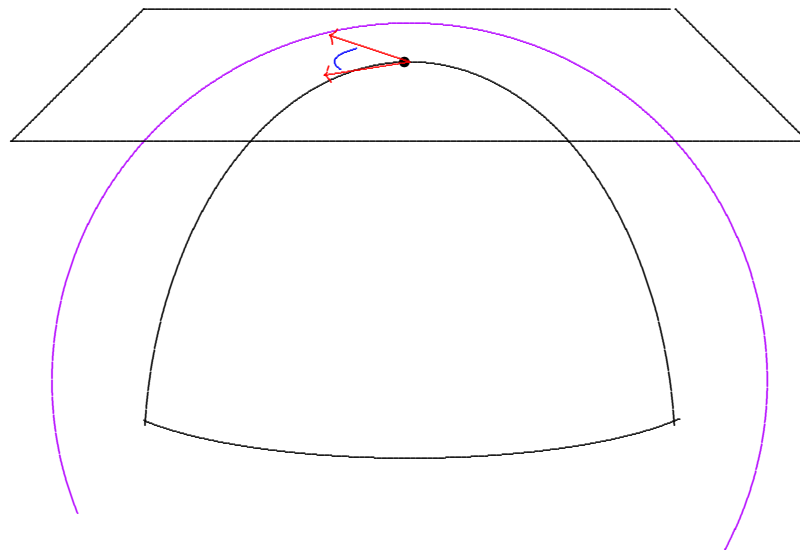

Hyper-Kähler metrics:

$(M^{4\ell}, g)$ hyper-Kähler \iff holonomy $\subset \mathbf{Sp}(\ell)$

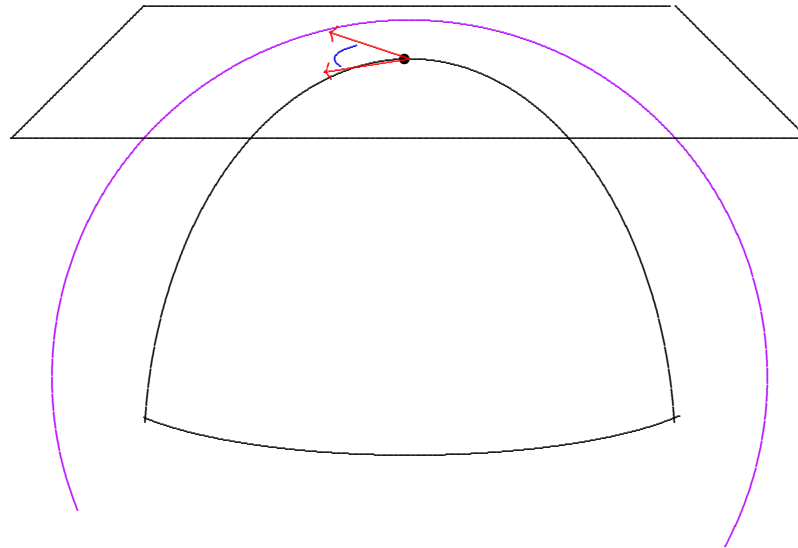

$$\mathbf{Sp}(\ell) := \mathbf{O}(4\ell) \cap \mathbf{GL}(\ell, \mathbb{H})$$

Hyper-Kähler metrics:

$(M^{4\ell}, g)$ hyper-Kähler \iff holonomy $\subset \mathbf{Sp}(\ell)$

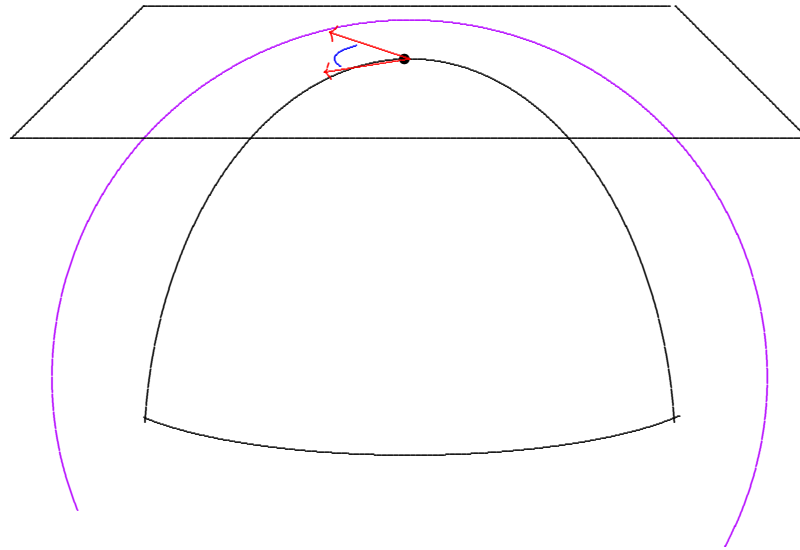

$$\mathbf{Sp}(\ell) \subset \mathbf{SU}(2\ell)$$

Hyper-Kähler metrics:

$(M^{4\ell}, g)$ hyper-Kähler \iff holonomy $\subset \mathbf{Sp}(\ell)$

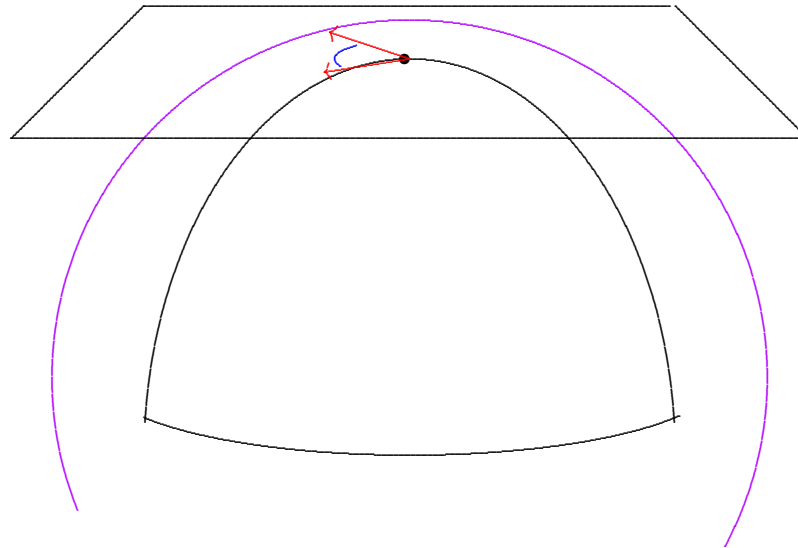

$$\mathbf{Sp}(\ell) \subset \mathbf{SU}(2\ell)$$

in many ways!

Hyper-Kähler metrics:

$(M^{4\ell}, g)$ hyper-Kähler \iff holonomy $\subset \mathbf{Sp}(\ell)$

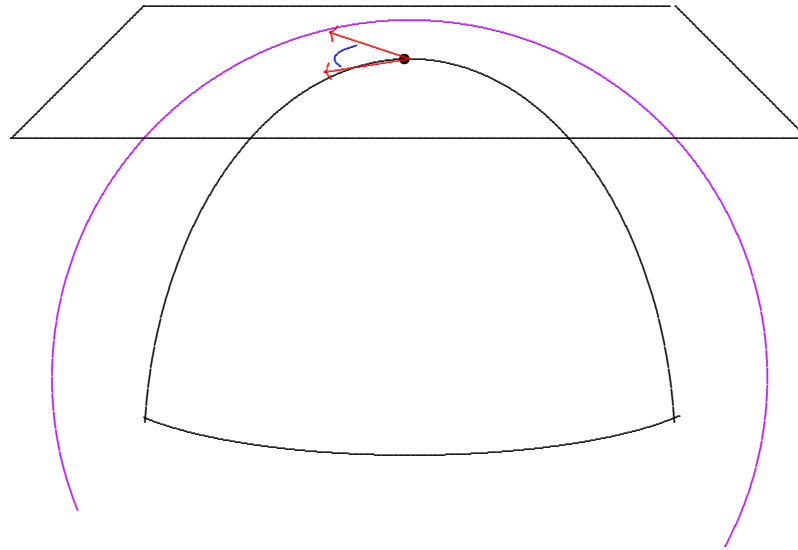

$$\mathbf{Sp}(\ell) \subset \mathbf{SU}(2\ell)$$

in many ways! (For example, permute $i, j, k \dots$)

Hyper-Kähler metrics:

$(M^{4\ell}, g)$ hyper-Kähler \iff holonomy $\subset \mathbf{Sp}(\ell)$

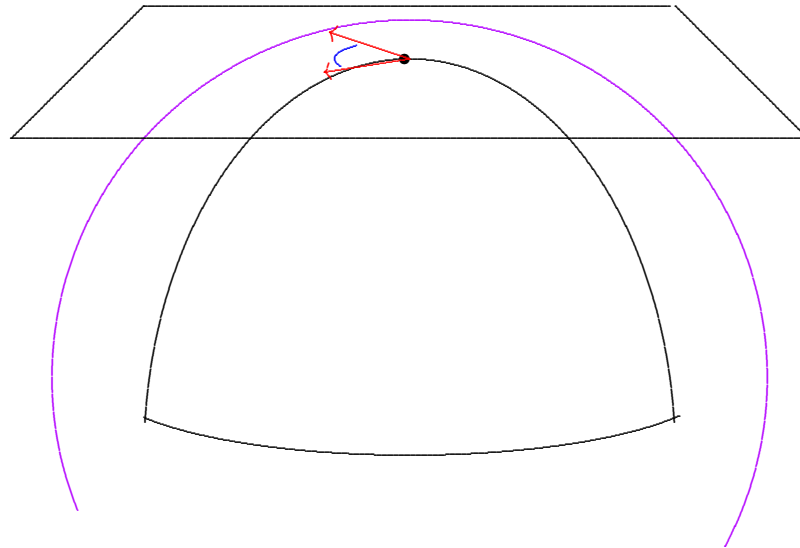

$$\mathbf{Sp}(\ell) \subset \mathbf{SU}(2\ell)$$

Ricci-flat and Kähler,

for many different complex structures!

Hyper-Kähler metrics:

$(M^{4\ell}, g)$ hyper-Kähler \iff holonomy $\subset \mathbf{Sp}(\ell)$

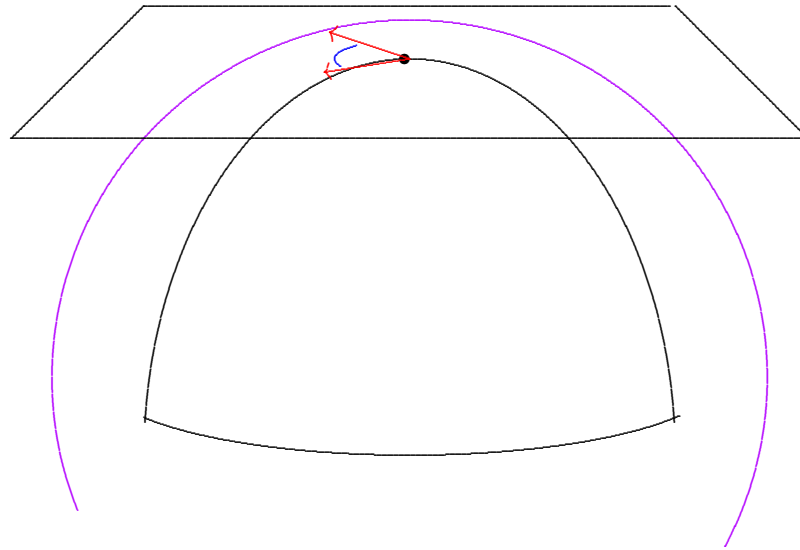

$$\mathbf{Sp}(\ell) \subset \mathbf{SU}(2\ell)$$

Hyper-Kähler metrics:

(M^4, g) hyper-Kähler \iff holonomy $\subset \mathbf{Sp}(1)$

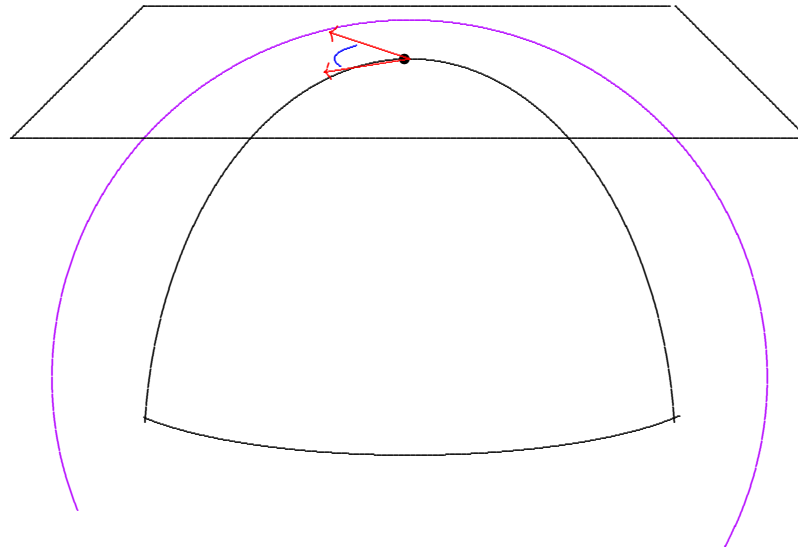

$$\mathbf{Sp}(1) = \mathbf{SU}(2)$$

Hyper-Kähler metrics:

(M^4, g) hyper-Kähler \iff holonomy $\subset \mathbf{Sp}(1)$

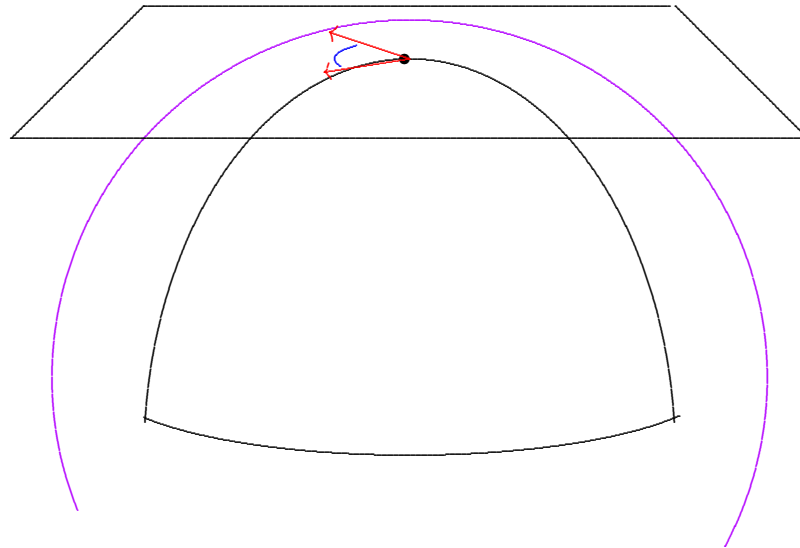

$$\mathbf{Sp}(1) = \mathbf{SU}(2)$$

When (M^4, g) simply connected:

hyper-Kähler \iff Ricci-flat Kähler.

Hyper-Kähler metrics:

(M^4, g) hyper-Kähler \iff holonomy $\subset \mathbf{Sp}(1)$

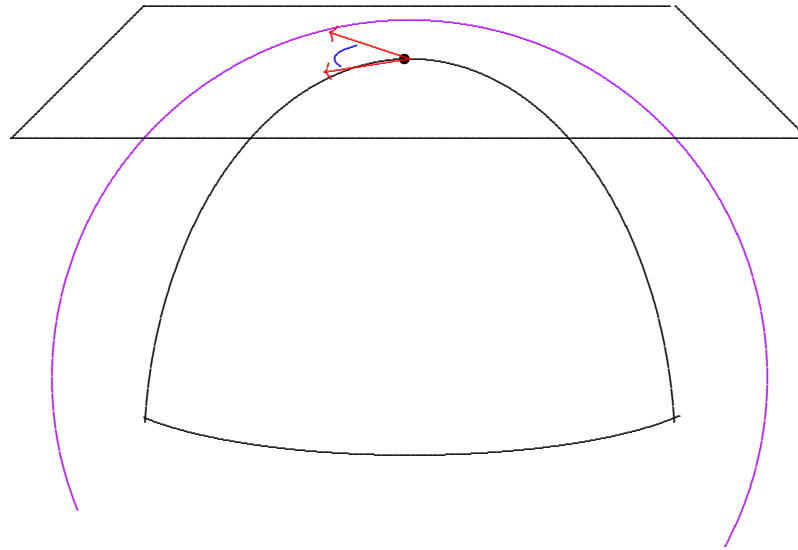

$$\mathbf{Sp}(1) = \mathbf{SU}(2)$$

Hyper-Kähler metrics:

(M^4, g) hyper-Kähler \iff holonomy $\subset \mathbf{Sp}(1)$

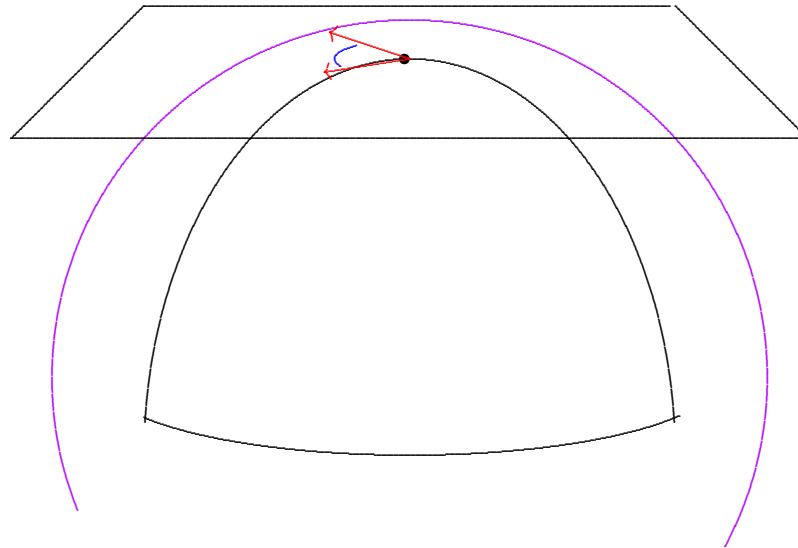

$$\mathbf{Sp}(1) = \mathbf{SU}(2)$$

Ricci-flat and Kähler,

for many different complex structures!

All these complex structures can be repackaged

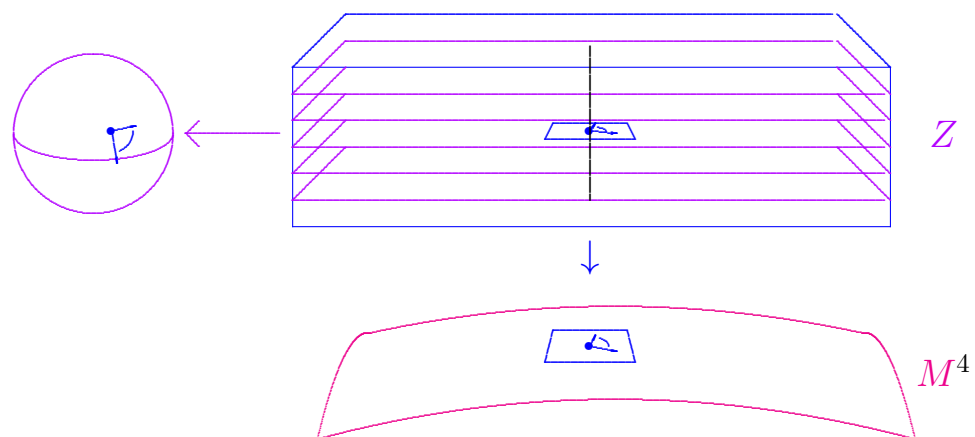

All these complex structures can be repackaged as

Penrose Twistor Space (Z^6, J) ,

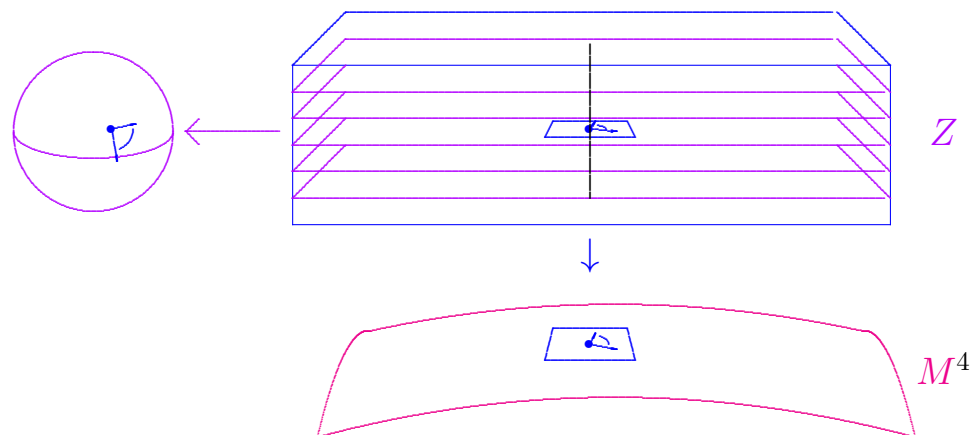

All these complex structures can be repackaged as

Penrose Twistor Space (Z^6, J) ,

which is a complex 3-manifold.

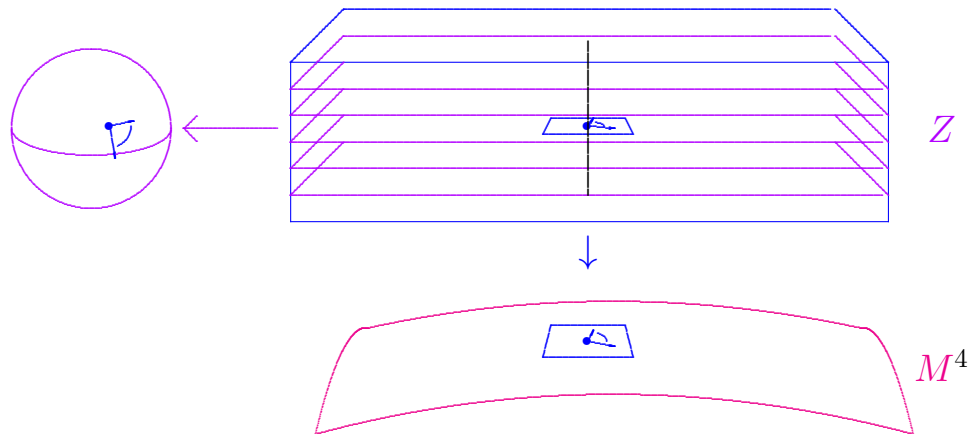

All these complex structures can be repackaged as

Penrose Twistor Space (Z^6, J) ,

which is a complex 3-manifold.

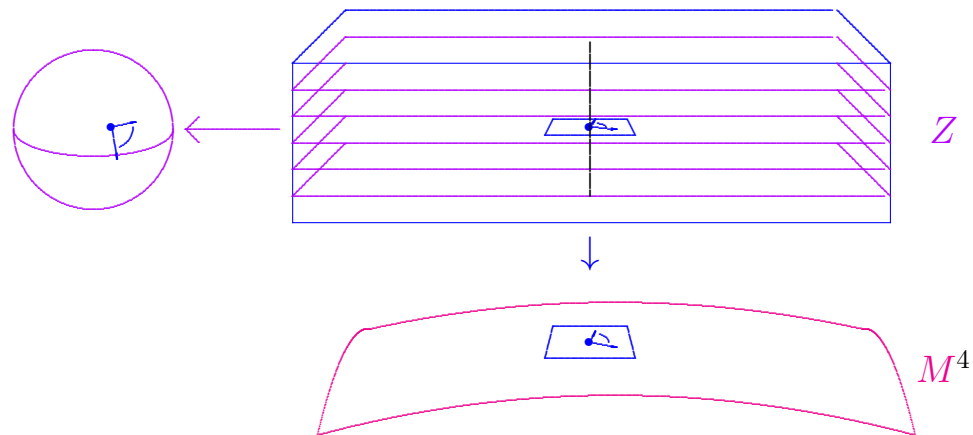

Complex structure faithfully encodes the metric.

All these complex structures can be repackaged as

Penrose Twistor Space (Z^6, J) ,

which is a complex 3-manifold.

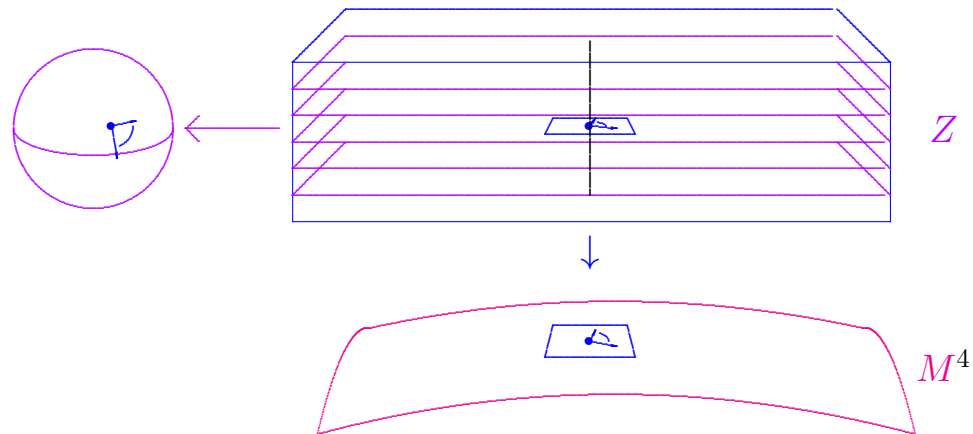

Complex structure encodes metric **mod homothety**.

All these complex structures can be repackaged as

Penrose Twistor Space (Z^6, J) ,

which is a complex 3-manifold.

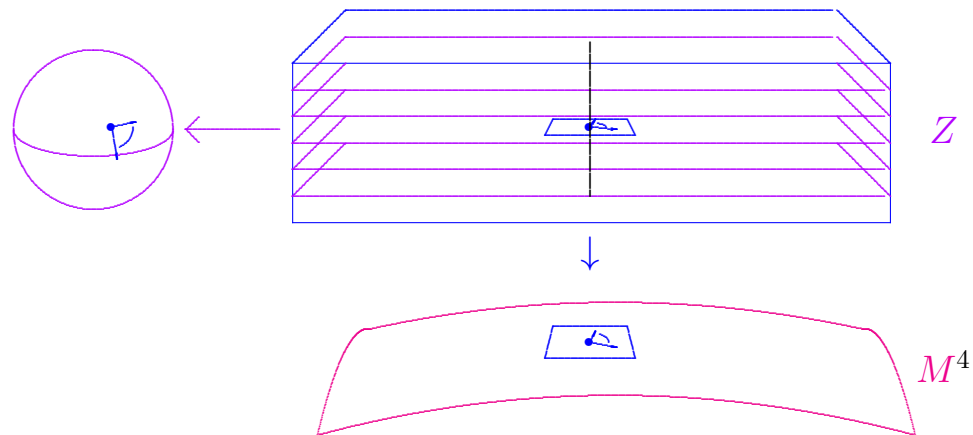

Complex structure faithfully encodes the metric.

All these complex structures can be repackaged as

Penrose Twistor Space (Z^6, J) ,

which is a complex 3-manifold.

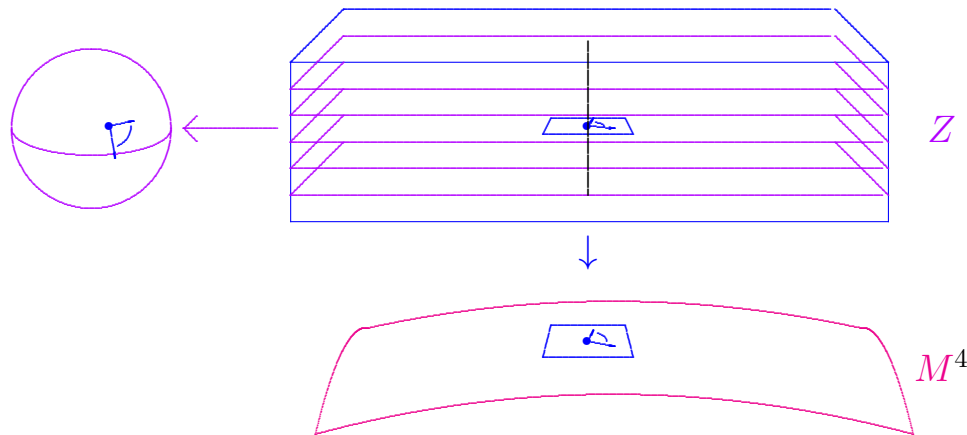

Complex structure faithfully encodes the metric.

Constructing twistor space suffices for existence.

Hitchin's Twistor Spaces:

Hitchin's Twistor Spaces:

$$H^0(\mathbb{CP}_1, \mathcal{O}(2)) = \mathbb{C}^3$$

Hitchin's Twistor Spaces:

$$H^0(\mathbb{CP}_1, \mathcal{O}(2)) = \mathbb{C}^3 \supset \mathbb{R}^3.$$

Hitchin's Twistor Spaces:

$$H^0(\mathbb{CP}_1, \mathcal{O}(2)) = \mathbb{C}^3 \supset \mathbb{R}^3.$$

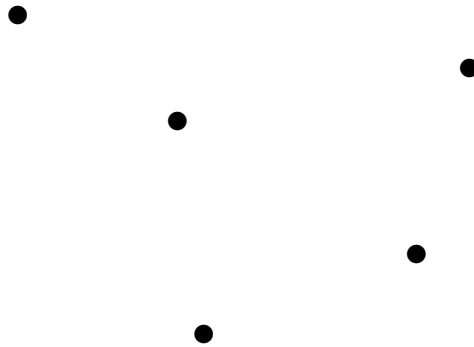

So ℓ points determine $P_1, \dots, P_\ell \in H^0(\mathbb{CP}_1, \mathcal{O}(2))$.

Hitchin's Twistor Spaces:

$$H^0(\mathbb{CP}_1, \mathcal{O}(2)) = \mathbb{C}^3 \supset \mathbb{R}^3.$$

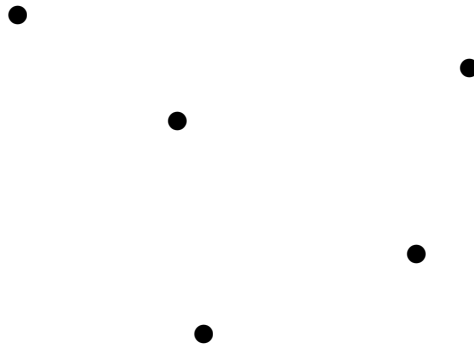

So ℓ points determine $P_1, \dots, P_\ell \in H^0(\mathbb{CP}_1, \mathcal{O}(2))$.

$$\tilde{Z} \subset \mathcal{O}(\ell) \oplus \mathcal{O}(\ell) \oplus \mathcal{O}(2)$$

Hitchin's Twistor Spaces:

$$H^0(\mathbb{CP}_1, \mathcal{O}(2)) = \mathbb{C}^3 \supset \mathbb{R}^3.$$

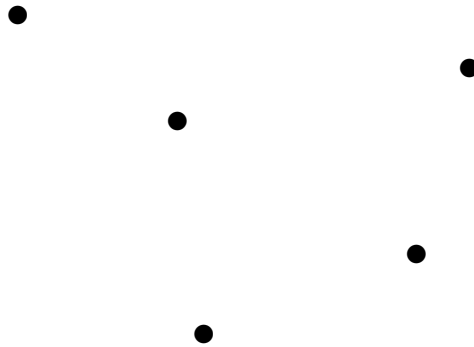

So ℓ points determine $P_1, \dots, P_\ell \in H^0(\mathbb{CP}_1, \mathcal{O}(2))$.

$$\tilde{Z} \subset \mathcal{O}(\ell) \oplus \mathcal{O}(\ell) \oplus \mathcal{O}(2)$$

$$xy = (z - P_1) \cdots (z - P_\ell)$$

Hitchin's Twistor Spaces:

$$H^0(\mathbb{C}P_1, \mathcal{O}(2)) = \mathbb{C}^3 \supset \mathbb{R}^3.$$

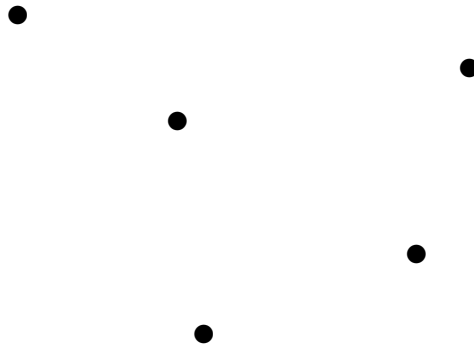

So ℓ points determine $P_1, \dots, P_\ell \in H^0(\mathbb{C}P_1, \mathcal{O}(2))$.

Small resolution Z of $\tilde{Z} \subset \mathcal{O}(\ell) \oplus \mathcal{O}(\ell) \oplus \mathcal{O}(2)$

$$xy = (z - P_1) \cdots (z - P_\ell)$$

Hitchin's Twistor Spaces:

$$H^0(\mathbb{CP}_1, \mathcal{O}(2)) = \mathbb{C}^3 \supset \mathbb{R}^3.$$

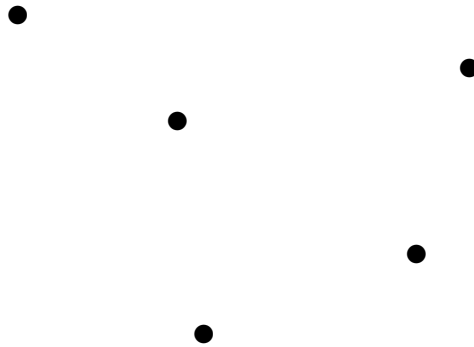

So ℓ points determine $P_1, \dots, P_\ell \in H^0(\mathbb{CP}_1, \mathcal{O}(2))$.

Small resolution Z of $\tilde{Z} \subset \mathcal{O}(\ell) \oplus \mathcal{O}(\ell) \oplus \mathcal{O}(2)$

$$xy = (z - P_1) \cdots (z - P_\ell)$$

is the twistor space of a Gibbons-Hawking metric.

Key examples:

Term **ALE** coined by Gibbons & Hawking, 1979.

They wrote down various explicit **Ricci-flat ALE** 4-manifolds they called **gravitational instantons**.

Their examples have just one end, with

$$\Gamma \cong \mathbb{Z}_\ell \subset \mathbf{SU}(2) \subset \mathbf{O}(4).$$

The G-H metrics are **hyper-Kähler**, and were soon independently rediscovered by Hitchin.

Key examples:

Term **ALE** coined by Gibbons & Hawking, 1979.

They wrote down various explicit **Ricci-flat ALE** 4-manifolds they called **gravitational instantons**.

Their examples have just one end, with

$$\Gamma \cong \mathbb{Z}_\ell \subset \mathbf{SU}(2) \subset \mathbf{O}(4).$$

The G-H metrics are **hyper-Kähler**, and were soon independently rediscovered by Hitchin.

Hitchin conjectured that similar metrics would exist for each finite $\Gamma \subset \mathbf{SU}(2)$.

Key examples:

Term **ALE** coined by Gibbons & Hawking, 1979.

They wrote down various explicit **Ricci-flat ALE** 4-manifolds they called **gravitational instantons**.

Their examples have just one end, with

$$\Gamma \cong \mathbb{Z}_\ell \subset \mathbf{SU}(2) \subset \mathbf{O}(4).$$

The G-H metrics are **hyper-Kähler**, and were soon independently rediscovered by Hitchin.

Hitchin conjectured that similar metrics would exist for each finite $\Gamma \subset \mathbf{SU}(2)$.

This conjecture was proved by Kronheimer, 1986.

Given $\Gamma \subset \mathbf{SU}(2)$

Given $\Gamma \subset \mathbf{SU}(2)$ finite subgroup,

Given $\Gamma \subset \mathbf{SU}(2)$ finite subgroup,
the orbifold \mathbb{C}^2/Γ

Given $\Gamma \subset \mathbf{SU}(2)$ finite subgroup,
the orbifold \mathbb{C}^2/Γ can be viewed as
singular complex surface

Given $\Gamma \subset \mathbf{SU}(2)$ finite subgroup,
the orbifold \mathbb{C}^2/Γ can be viewed as
singular complex surface by
choosing generators of Γ -invariant polynomials.

Given $\Gamma \subset \mathbf{SU}(2)$ finite subgroup,
the orbifold \mathbb{C}^2/Γ can be viewed as
singular complex surface $\subset \mathbb{C}^3$ by
choosing 3 generators of Γ -invariant polynomials.

Given $\Gamma \subset \mathbf{SU}(2)$ finite subgroup,
the orbifold \mathbb{C}^2/Γ can be viewed as
singular complex surface $\subset \mathbb{C}^3$ by
choosing 3 generators of Γ -invariant polynomials.

Example. $\begin{bmatrix} e^{2\pi i/m} & \\ & e^{-2\pi i/m} \end{bmatrix} \in \mathbf{SU}(2)$

Given $\Gamma \subset \mathbf{SU}(2)$ finite subgroup,
the orbifold \mathbb{C}^2/Γ can be viewed as
singular complex surface $\subset \mathbb{C}^3$ by
choosing 3 generators of Γ -invariant polynomials.

Example. $\begin{bmatrix} e^{2\pi i/m} & \\ & e^{-2\pi i/m} \end{bmatrix} \in \mathbf{SU}(2)$

generates $\Gamma \cong \mathbb{Z}_m$.

Given $\Gamma \subset \mathbf{SU}(2)$ finite subgroup,
the orbifold \mathbb{C}^2/Γ can be viewed as
singular complex surface $\subset \mathbb{C}^3$ by
choosing 3 generators of Γ -invariant polynomials.

Example. $\begin{bmatrix} e^{2\pi i/m} & \\ & e^{-2\pi i/m} \end{bmatrix} \in \mathbf{SU}(2)$

generates $\Gamma \cong \mathbb{Z}_m$. Setting

$$u = z_1^m, \quad v = z_2^m, \quad y = z_1 z_2,$$

Given $\Gamma \subset \mathbf{SU}(2)$ finite subgroup,
the orbifold \mathbb{C}^2/Γ can be viewed as
singular complex surface $\subset \mathbb{C}^3$ by
choosing 3 generators of Γ -invariant polynomials.

Example. $\begin{bmatrix} e^{2\pi i/m} & \\ & e^{-2\pi i/m} \end{bmatrix} \in \mathbf{SU}(2)$

generates $\Gamma \cong \mathbb{Z}_m$. Setting

$$u = z_1^m, \quad v = z_2^m, \quad y = z_1 z_2,$$

then identifies \mathbb{C}^2/Γ with

$$uv = y^m.$$

Given $\Gamma \subset \mathbf{SU}(2)$ finite subgroup,
the orbifold \mathbb{C}^2/Γ can be viewed as
singular complex surface $\subset \mathbb{C}^3$ by
choosing 3 generators of Γ -invariant polynomials.

Example.
$$\begin{bmatrix} e^{2\pi i/m} & \\ & e^{-2\pi i/m} \end{bmatrix} \in \mathbf{SU}(2)$$

generates $\Gamma \cong \mathbb{Z}_m$. Setting

$$w = \frac{1}{2}(z_1^m - z_2^m), \quad x = \frac{i}{2}(z_1^m + z_2^m), \quad y = z_1 z_2,$$

then identifies \mathbb{C}^2/Γ with

$$w^2 + x^2 + y^m = 0.$$

Felix Klein's Table of Singularities (1884)

Felix Klein's Table of Singularities (1884)

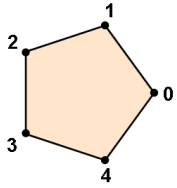
 \mathbb{Z}_m 

$$w^2 + x^2 + y^m = 0$$

Felix Klein's Table of Singularities (1884)

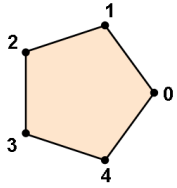
 \mathbb{Z}_m 

$$w^2 + x^2 + y^m = 0$$

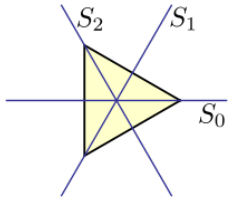
 Dih_m^* 

$$w^2 + y(x^2 + y^m) = 0$$

Felix Klein's Table of Singularities (1884)

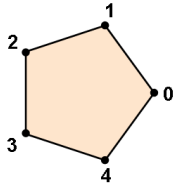
 \mathbb{Z}_m 

$$w^2 + x^2 + y^m = 0$$

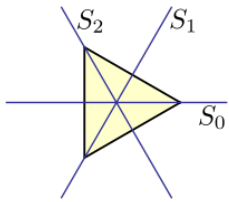
 Dih_m^* 

$$w^2 + y(x^2 + y^m) = 0$$

 T^* 

$$w^2 + x^3 + y^4 = 0$$

Felix Klein's Table of Singularities (1884)

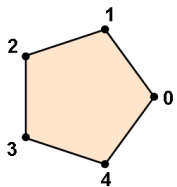

Z_m



$$w^2 + x^2 + y^m = 0$$

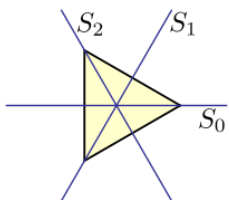

Dih_m^*



$$w^2 + y(x^2 + y^m) = 0$$



T^*



$$w^2 + x^3 + y^4 = 0$$

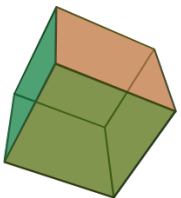

O^*



$$w^2 + x^3 + xy^3 = 0$$

Felix Klein's Table of Singularities (1884)

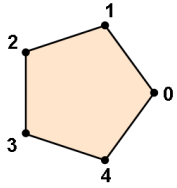

Z_m



$$w^2 + x^2 + y^m = 0$$

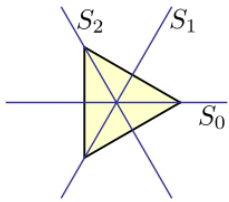

Dih_m^*



$$w^2 + y(x^2 + y^m) = 0$$



T^*



$$w^2 + x^3 + y^4 = 0$$

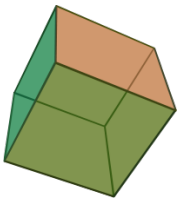

O^*



$$w^2 + x^3 + xy^3 = 0$$

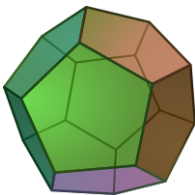

I^*



$$w^2 + x^3 + y^5 = 0$$

Prototypical Klein singularity:

$$w^2 + x^2 + y^2 = 0$$

Two ways to get rid of a singularity:

$$w^2 + x^2 + y^2 = 0$$

Two ways to get rid of a singularity:

- Smooth it, by deformation:

$$w^2 + x^2 + y^2 = 0$$

Two ways to get rid of a singularity:

- Smooth it, by deformation:

$$w^2 + x^2 + y^2 = \epsilon$$

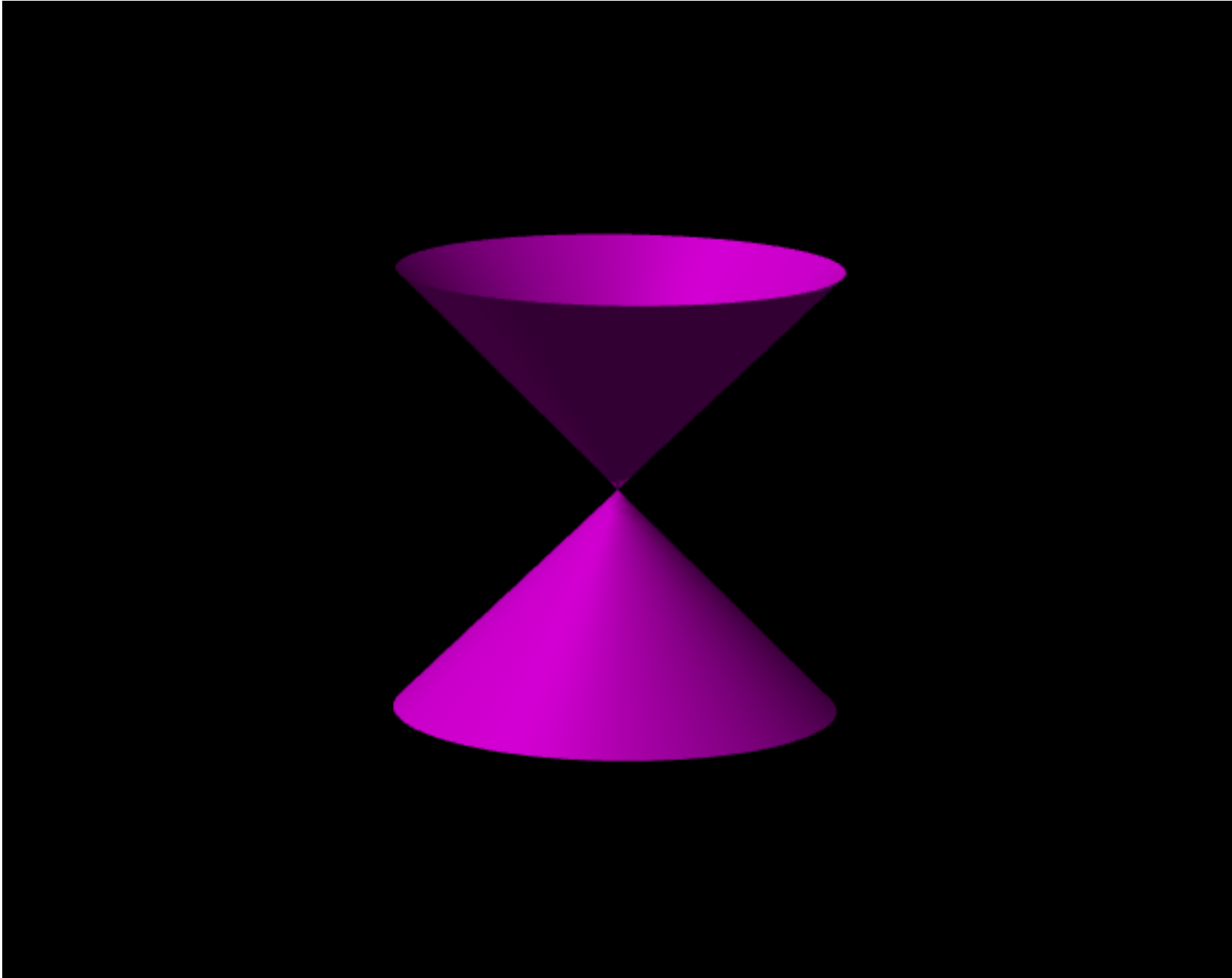

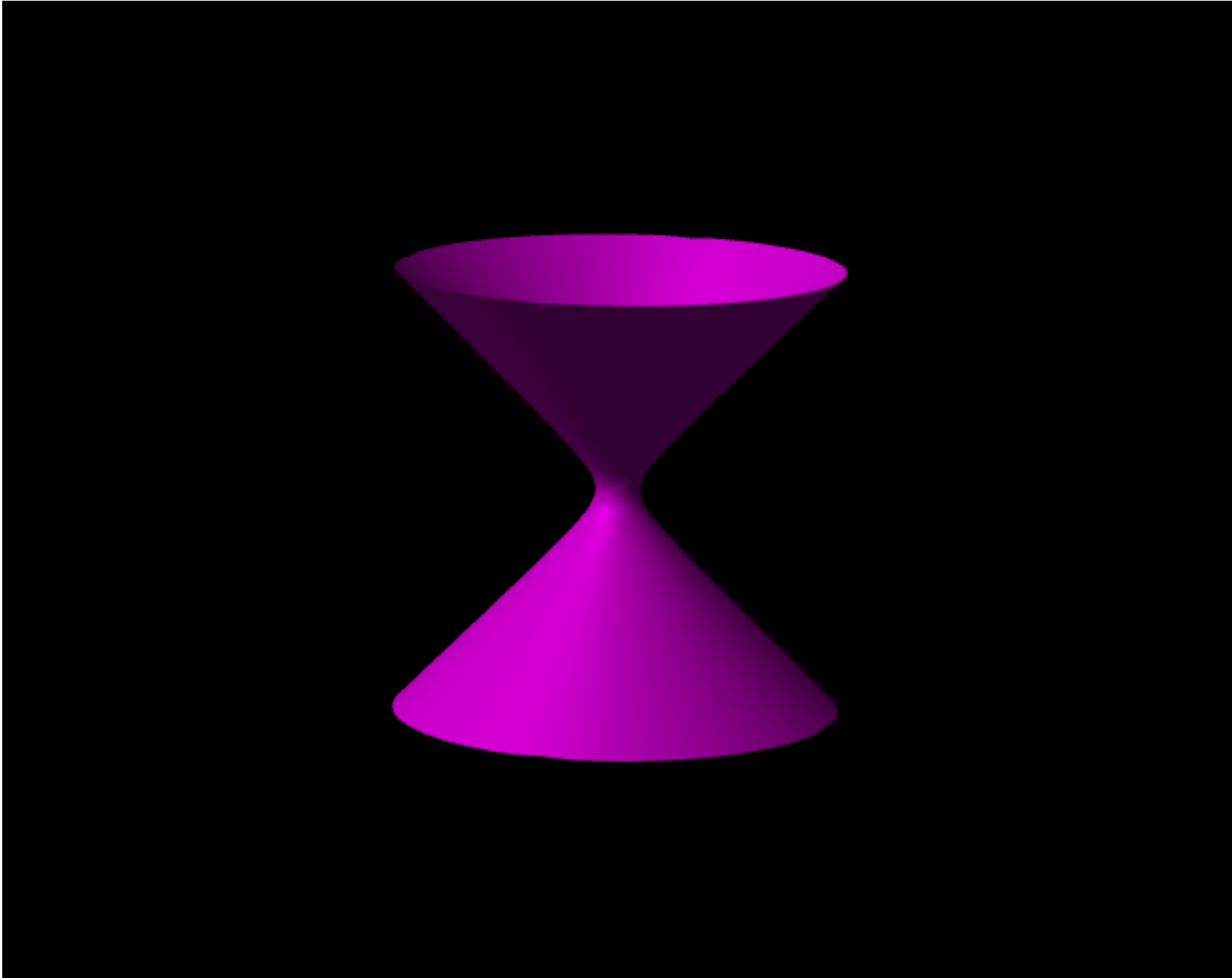

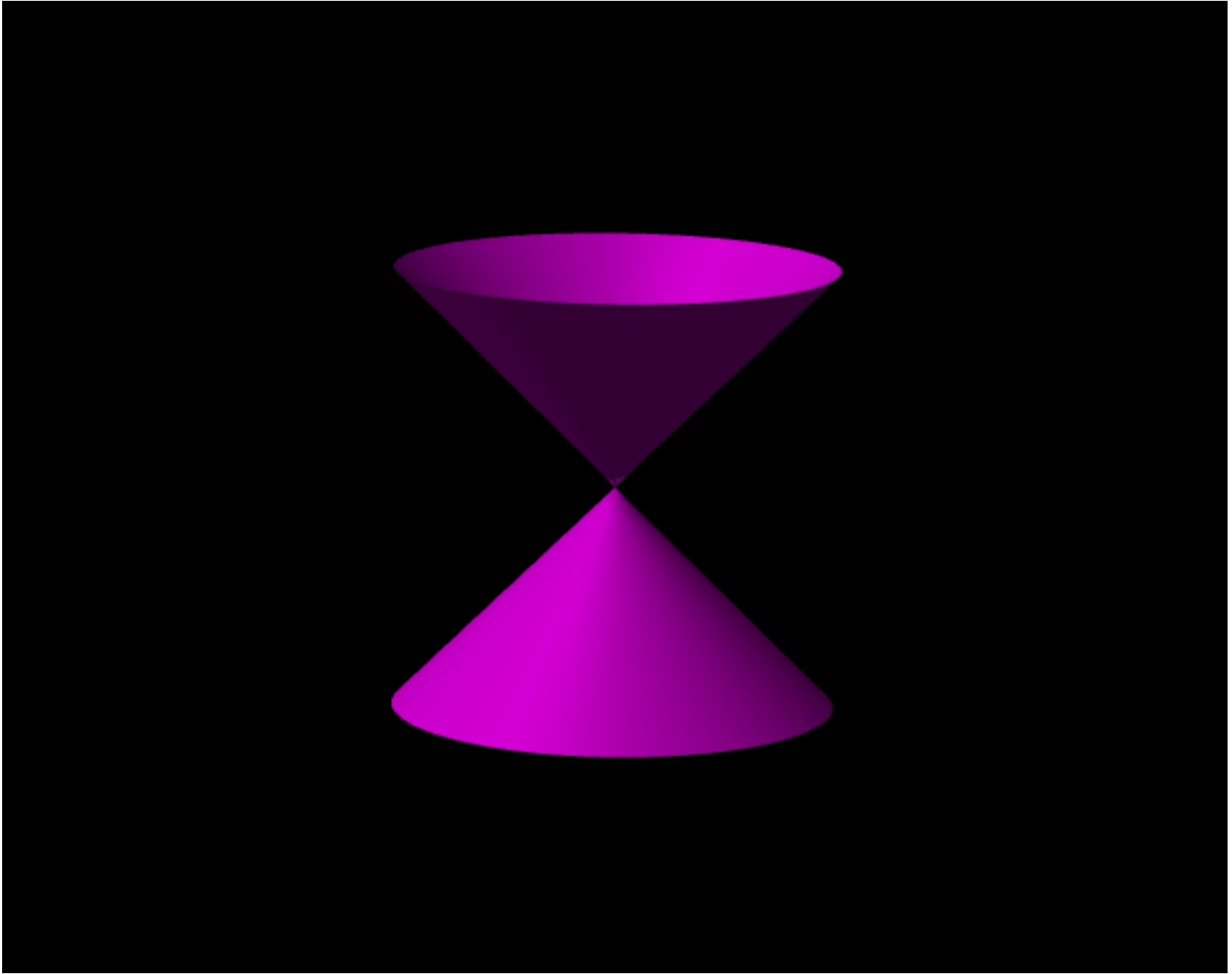

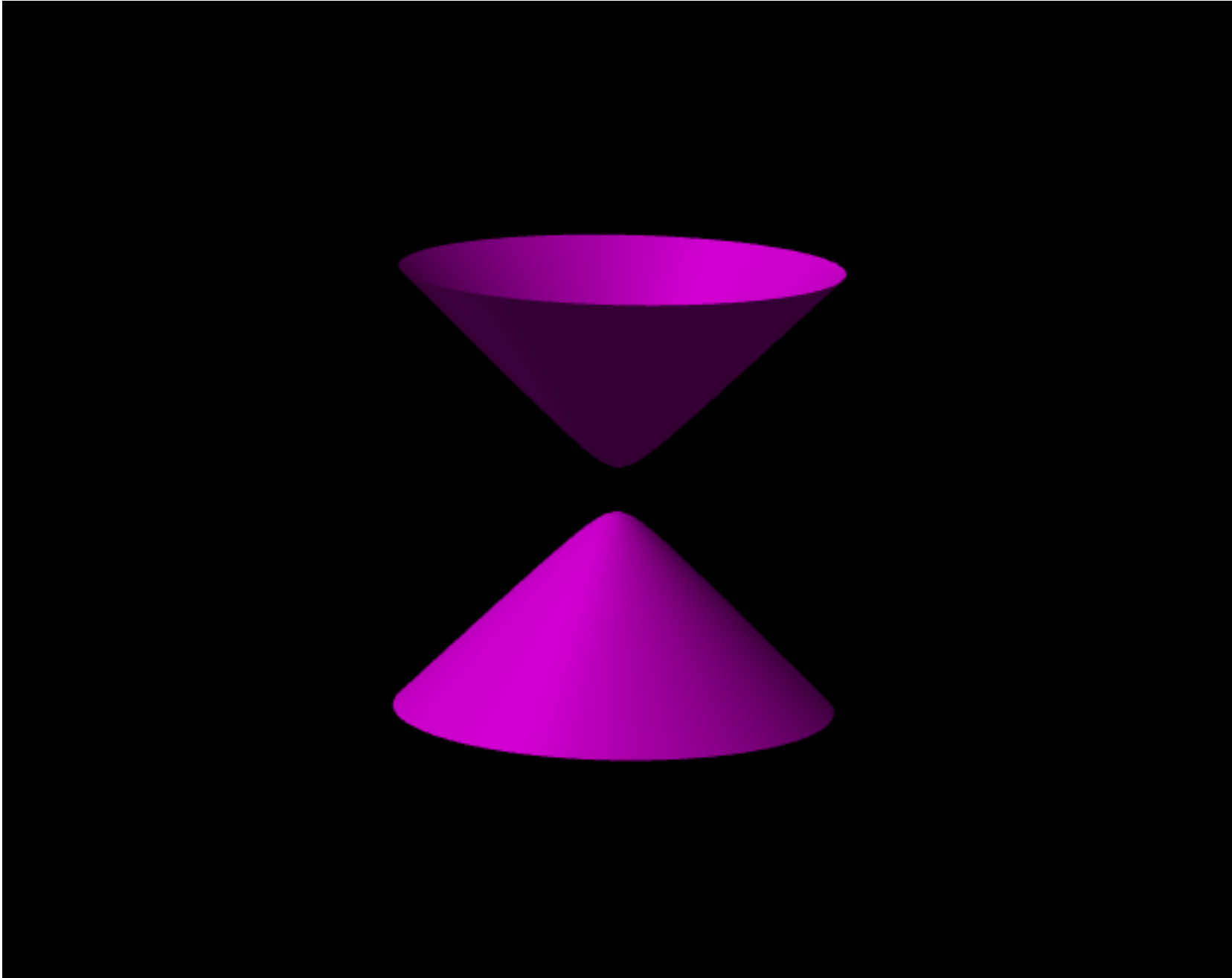

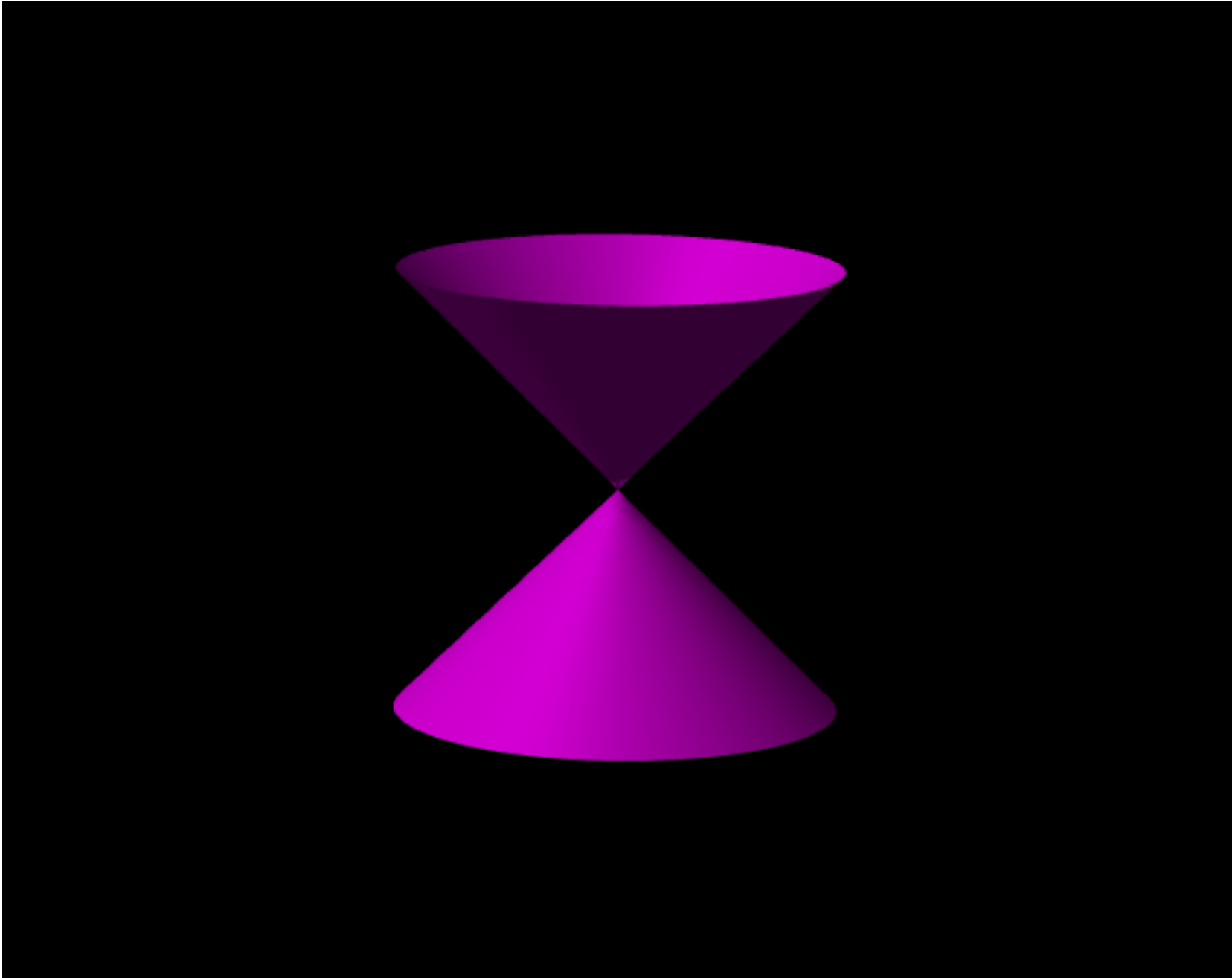

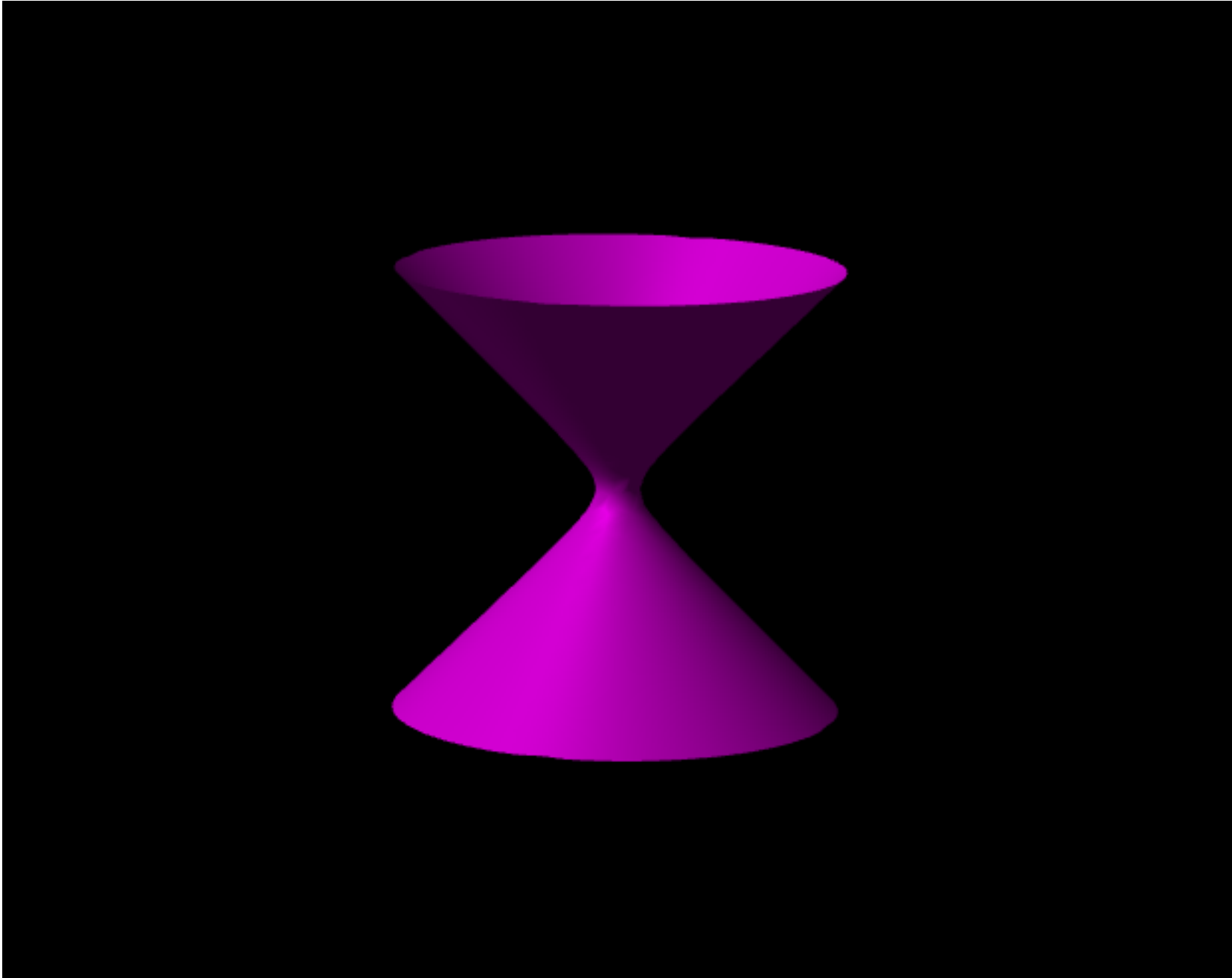

Two ways to get rid of a singularity:

- Smooth it, by deformation:

$$w^2 + x^2 + y^2 = \epsilon$$

Two ways to get rid of a singularity:

- Smooth it, by deformation:

$$w^2 + x^2 + y^2 = \epsilon$$

- Resolve it, by blowing up,

$$w^2 + x^2 + y^2 = 0$$

Two ways to get rid of a singularity:

- Smooth it, by deformation:

$$w^2 + x^2 + y^2 = \epsilon$$

- Resolve it, by blowing up,

$$w^2 + x^2 + y^2 = 0$$

$$\mathcal{O}(-1)$$



$$\mathbb{C}P_2$$

Two ways to get rid of a singularity:

- Smooth it, by deformation:

$$w^2 + x^2 + y^2 = \epsilon$$

- Resolve it, by blowing up,

$$w^2 + x^2 + y^2 = 0$$

$$\begin{array}{ccc} & & \mathcal{O}(-1) \\ & & \downarrow \\ \mathbb{CP}_1 & \hookrightarrow & \mathbb{CP}_2 \end{array}$$

Two ways to get rid of a singularity:

- Smooth it, by deformation:

$$w^2 + x^2 + y^2 = \epsilon$$

- Resolve it, by blowing up, iteratively:

$$w^2 + x^2 + y^2 = 0$$

$$\begin{array}{ccc} \mathcal{O}(-2) & \rightarrow & \mathcal{O}(-1) \\ \downarrow & & \downarrow \\ \mathbb{CP}_1 & \hookrightarrow & \mathbb{CP}_2 \end{array}$$

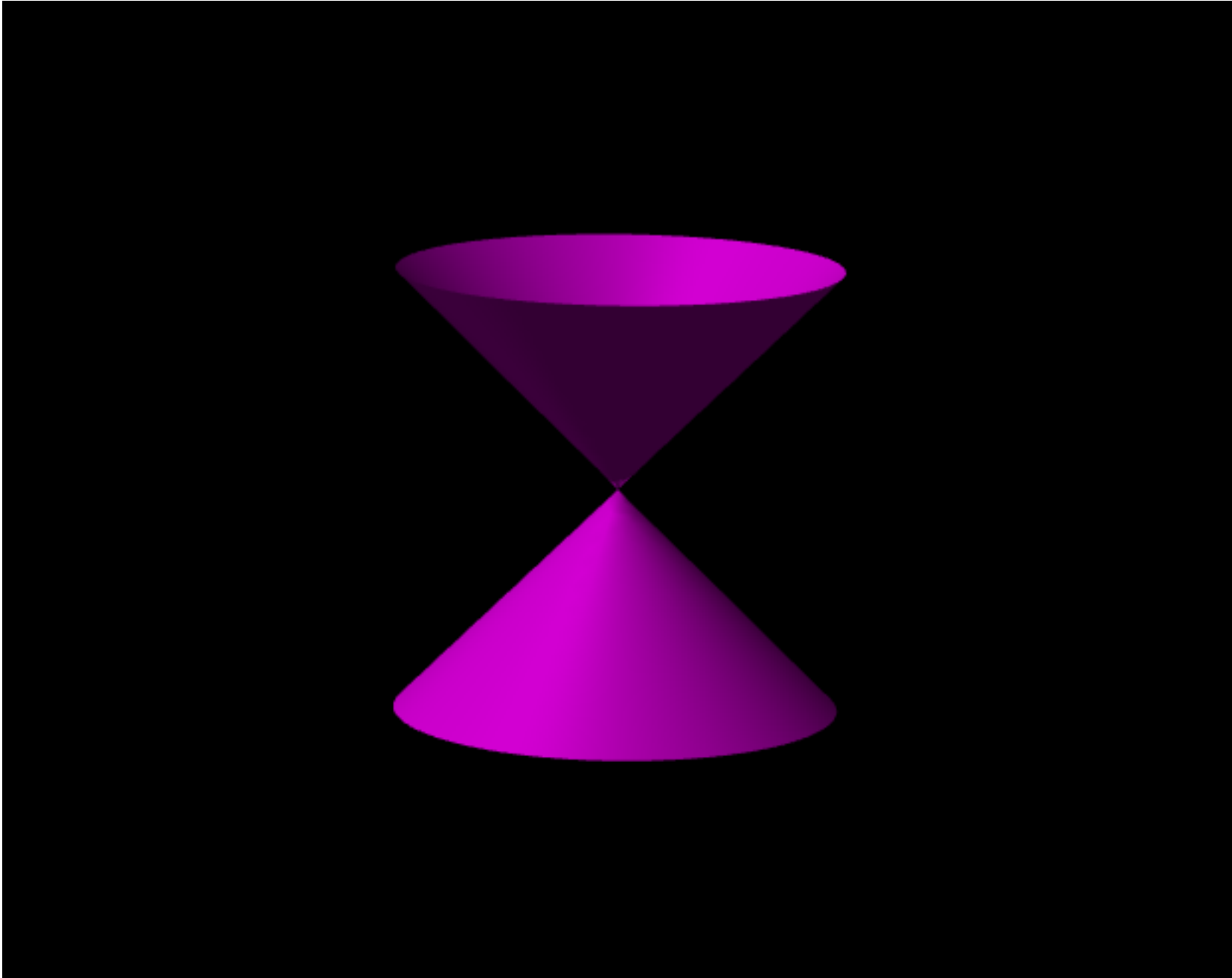

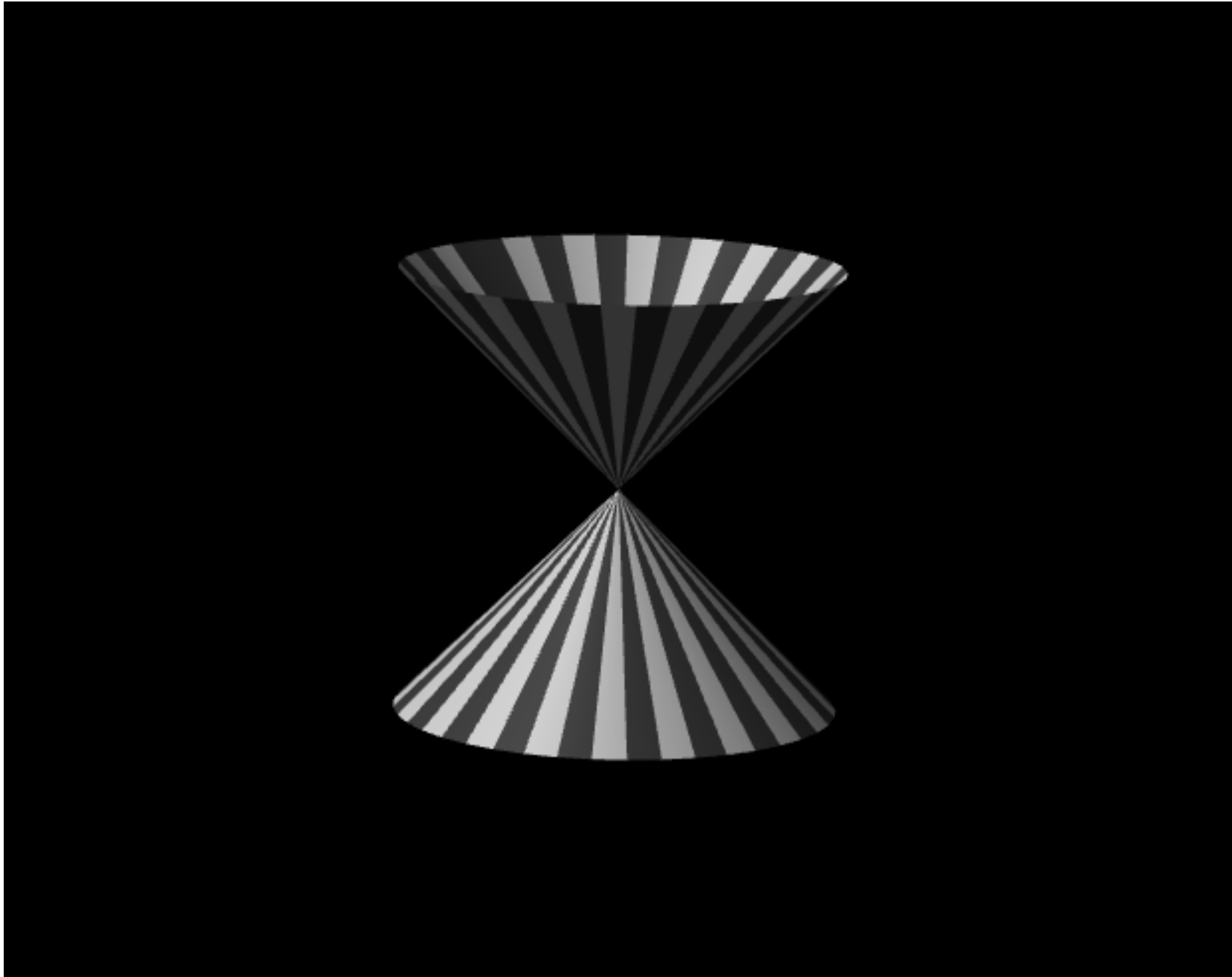

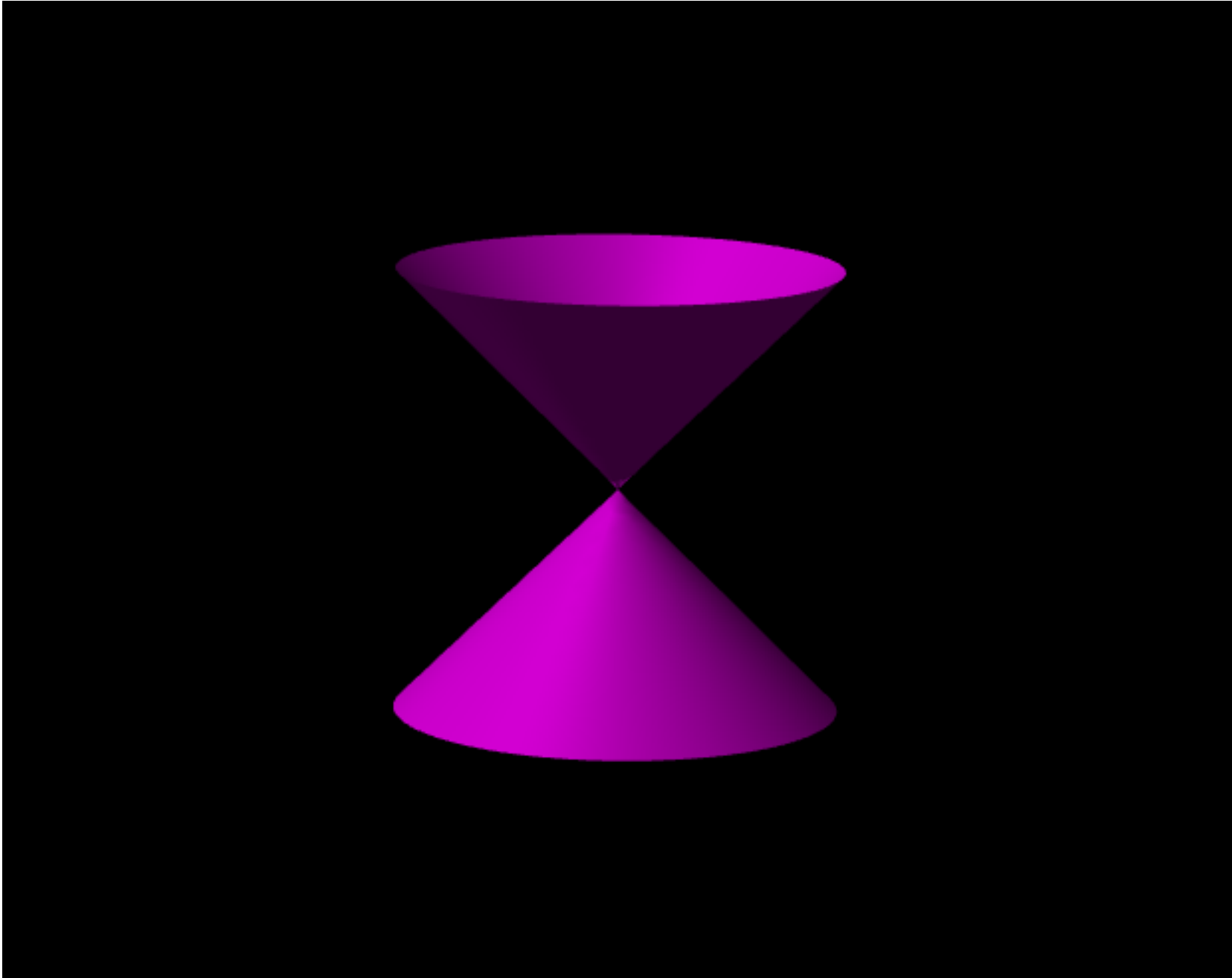

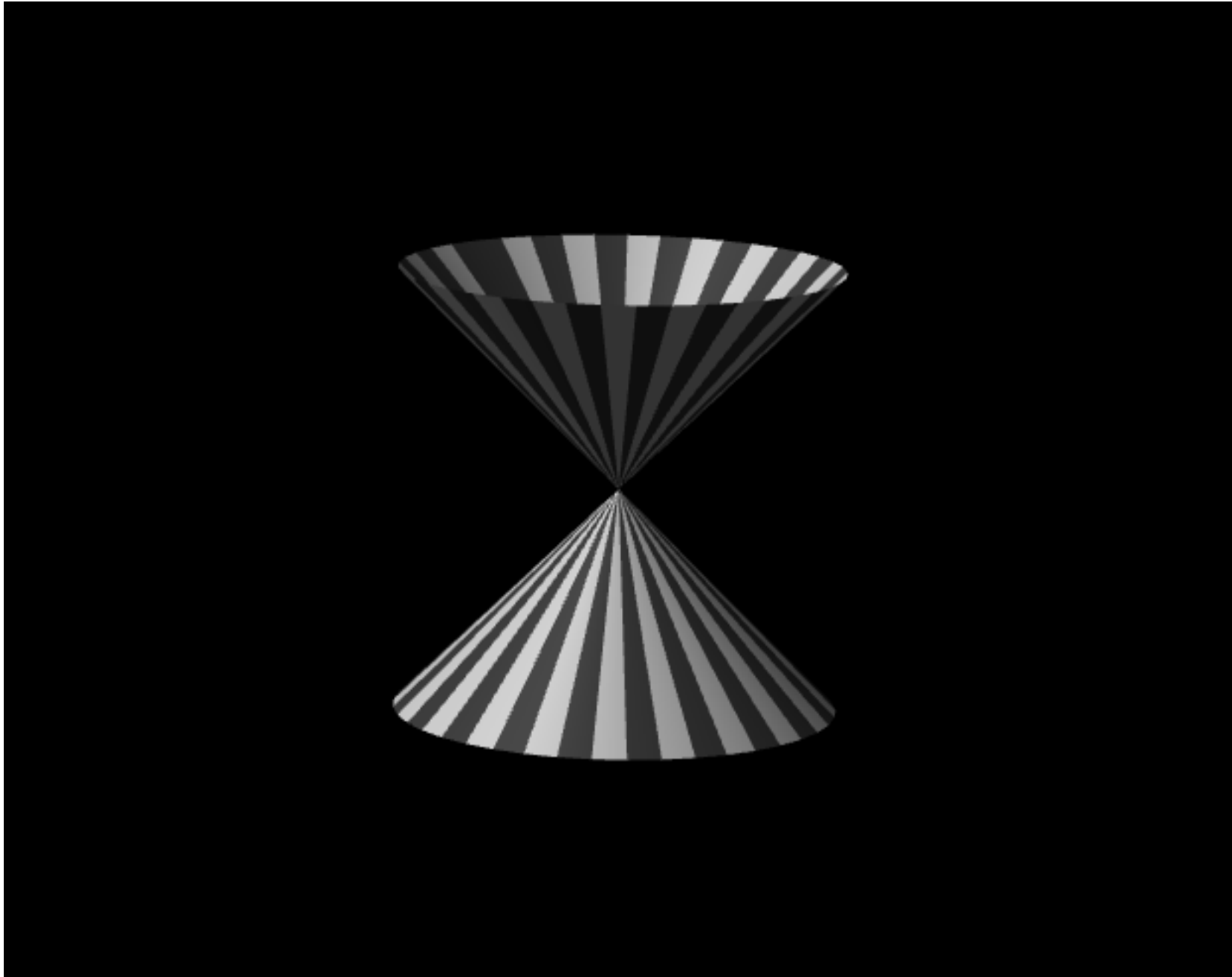

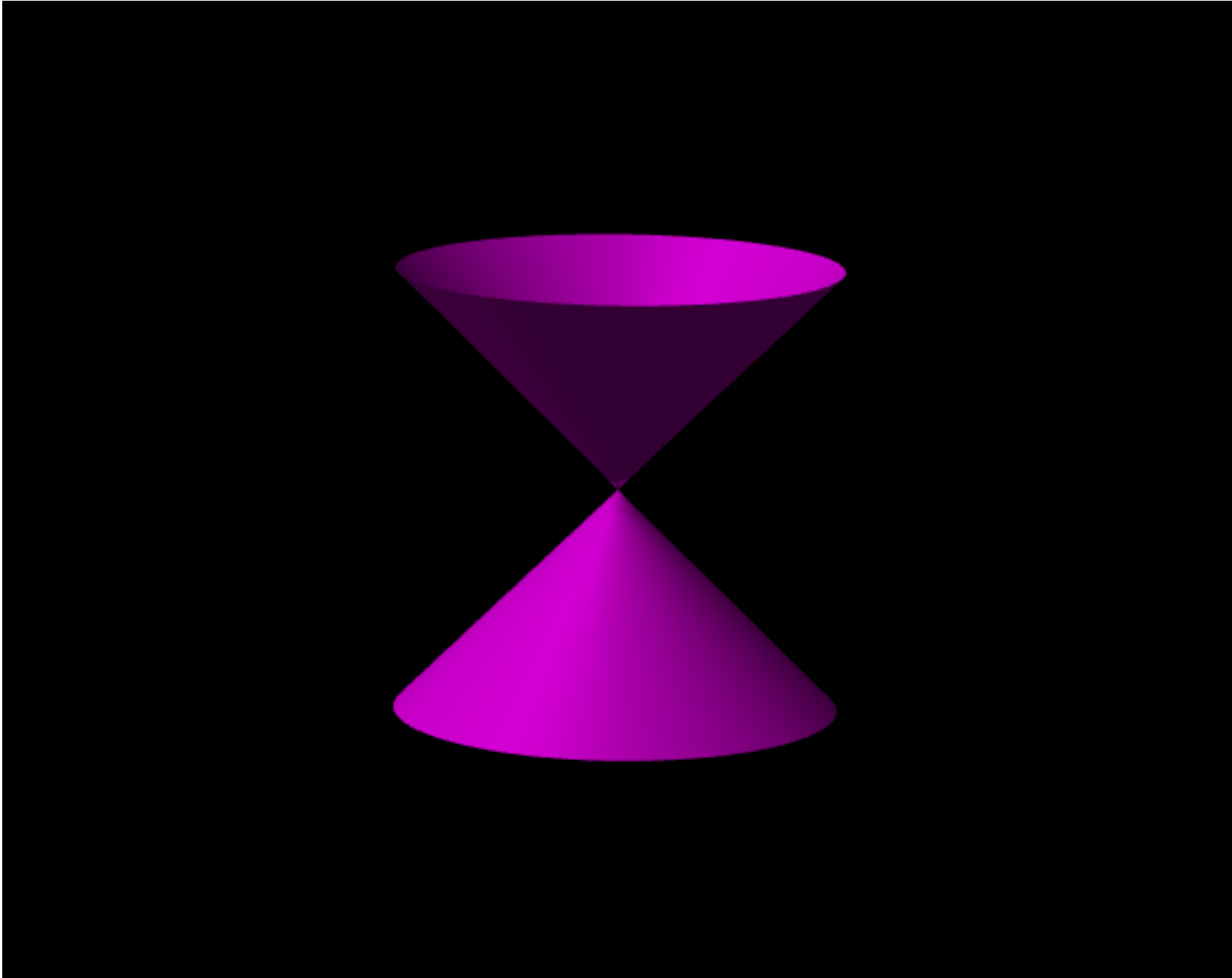

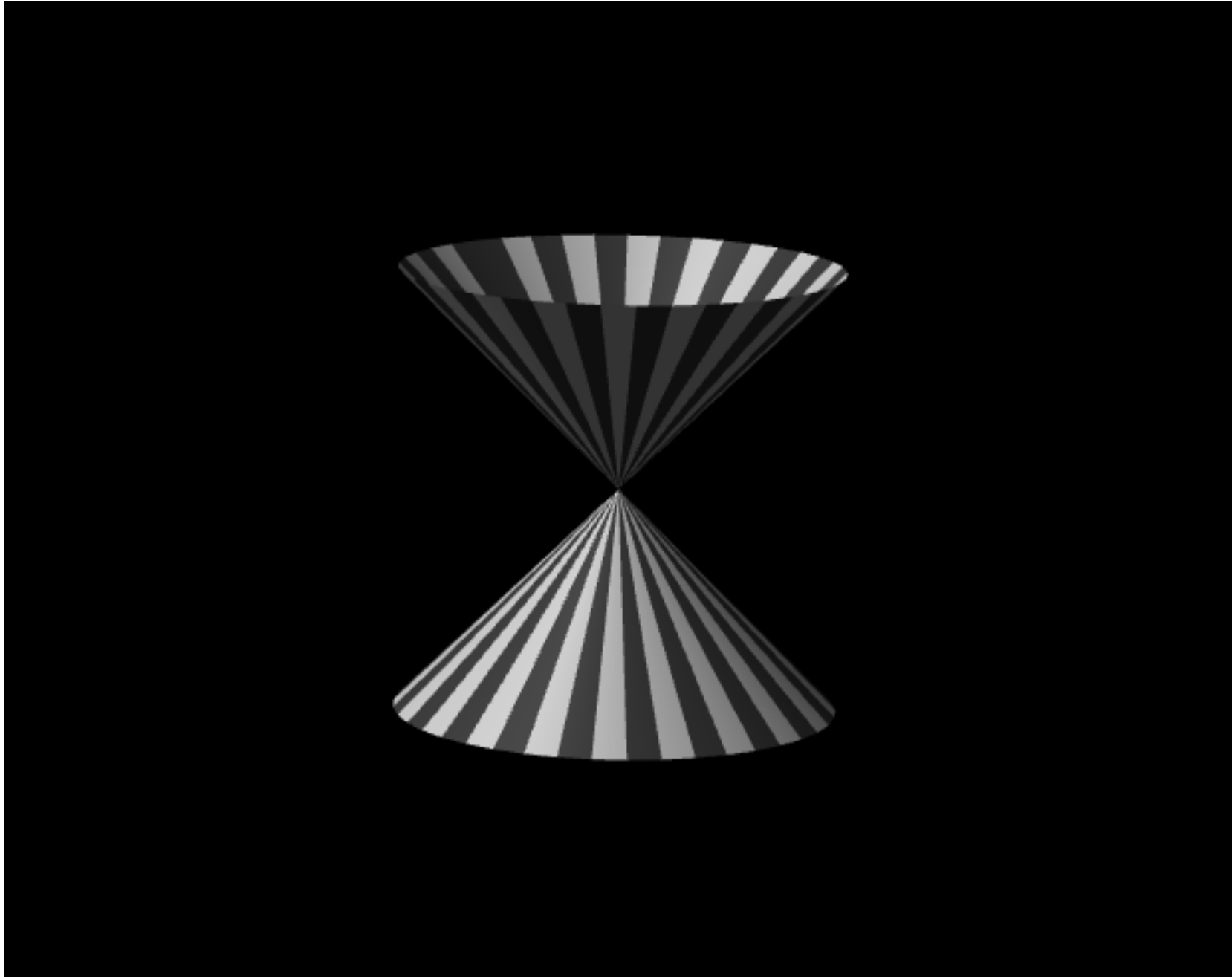

Two ways to get rid of a singularity:

- Smooth it, by deformation:

$$w^2 + x^2 + y^2 = \epsilon$$

- Resolve it, by blowing up, iteratively:

$$w^2 + x^2 + y^2 = 0$$

$$\begin{array}{ccc} \mathcal{O}(-2) & \rightarrow & \mathcal{O}(-1) \\ \downarrow & & \downarrow \\ \mathbb{C}P_1 & \hookrightarrow & \mathbb{C}P_2 \end{array}$$

Two ways to get rid of a singularity:

- Smooth it, by deformation:

$$w^2 + x^2 + y^2 = \epsilon$$

- Resolve it, by blowing up, iteratively:

$$w^2 + x^2 + y^2 = 0$$

$$\begin{array}{ccc} \mathcal{O}(-2) & \rightarrow & \mathcal{O}(-1) \\ \downarrow & & \downarrow \\ \mathbb{C}P_1 & \hookrightarrow & \mathbb{C}P_2 \end{array}$$

Usually these are topologically different.

Two ways to get rid of a singularity:

- Smooth it, by deformation:

$$w^2 + x^2 + y^2 = \epsilon$$

- Resolve it, by blowing up, iteratively:

$$w^2 + x^2 + y^2 = 0$$

$$\begin{array}{ccc} \mathcal{O}(-2) & \rightarrow & \mathcal{O}(-1) \\ \downarrow & & \downarrow \\ \mathbb{CP}_1 & \hookrightarrow & \mathbb{CP}_2 \end{array}$$

Usually these are topologically different.

But for Klein singularities, they are diffeomorphic!

Two ways to get rid of a singularity:

- Smooth it, by deformation:

$$w^2 + x^2 + y^2 = \epsilon$$

- Resolve it, by blowing up, iteratively:

$$w^2 + x^2 + y^2 = 0$$

$$\begin{array}{ccc} \mathcal{O}(-2) & \rightarrow & \mathcal{O}(-1) \\ \downarrow & & \downarrow \\ \mathbb{C}P_1 & \hookrightarrow & \mathbb{C}P_2 \end{array}$$

Usually these are topologically different.

But for Klein singularities, they are diffeomorphic!

Gorenstein singularities.

Two ways to get rid of a singularity:

- Smooth it, by deformation:

$$w^2 + x^2 + y^2 = \epsilon$$

- Resolve it, by blowing up, iteratively:

$$w^2 + x^2 + y^2 = 0$$

$$\begin{array}{ccc} \mathcal{O}(-2) & \rightarrow & \mathcal{O}(-1) \\ \downarrow & & \downarrow \\ \mathbb{CP}_1 & \hookrightarrow & \mathbb{CP}_2 \end{array}$$

Usually these are topologically different.

But for Klein singularities, they are diffeomorphic!

Gorenstein singularities. Crepant Resolutions.

Resolutions of Klein Singularities:

Resolutions of Klein Singularities:

\forall Klein singularity $V \subset \mathbb{C}^3$,

Resolutions of Klein Singularities:

\forall Klein singularity $V \subset \mathbb{C}^3$, $\exists!$ resolution

$$\hat{V} \rightarrow V$$

Resolutions of Klein Singularities:

\forall Klein singularity $V \subset \mathbb{C}^3$, $\exists!$ resolution

$$\hat{V} \rightarrow V$$

with $c_1(T^{1,0}\hat{V}) = 0$.

Resolutions of Klein Singularities:

\forall Klein singularity $V \subset \mathbb{C}^3$, $\exists!$ resolution

$$\hat{V} \rightarrow V$$

with $c_1(T^{1,0}\hat{V}) = 0$.

Replaces origin with a union of $\mathbb{C}P_1$'s,

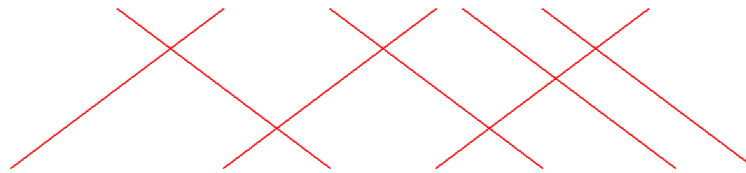

Resolutions of Klein Singularities:

\forall Klein singularity $V \subset \mathbb{C}^3$, $\exists!$ resolution

$$\hat{V} \rightarrow V$$

with $c_1(T^{1,0}\hat{V}) = 0$.

Replaces origin with a union of $\mathbb{C}P_1$'s,
each with self-intersection -2 ,

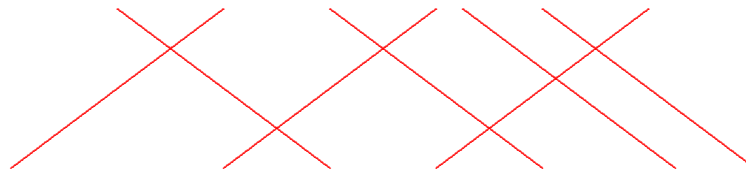

Resolutions of Klein Singularities:

\forall Klein singularity $V \subset \mathbb{C}^3$, $\exists!$ resolution

$$\hat{V} \rightarrow V$$

with $c_1(T^{1,0}\hat{V}) = 0$.

Replaces origin with a union of $\mathbb{C}P_1$'s,
each with self-intersection -2 ,
meeting transversely,

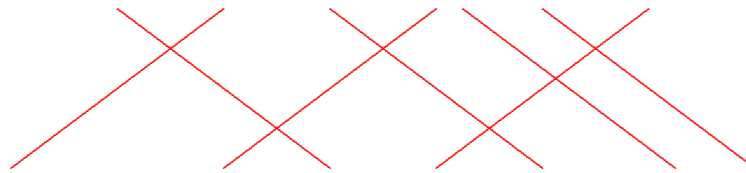

Resolutions of Klein Singularities:

\forall Klein singularity $V \subset \mathbb{C}^3$, $\exists!$ resolution

$$\hat{V} \rightarrow V$$

with $c_1(T^{1,0}\hat{V}) = 0$.

Replaces origin with a union of $\mathbb{C}P_1$'s,
each with self-intersection -2 ,
meeting transversely, & forming connected set:

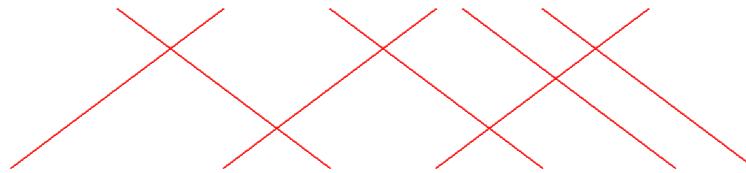

Resolutions of Klein Singularities:

\forall Klein singularity $V \subset \mathbb{C}^3$, $\exists!$ resolution

$$\hat{V} \rightarrow V$$

with $c_1(T^{1,0}\hat{V}) = 0$.

Replaces origin with a union of $\mathbb{C}\mathbb{P}_1$'s,
each with self-intersection -2 ,
meeting transversely, & forming connected set:

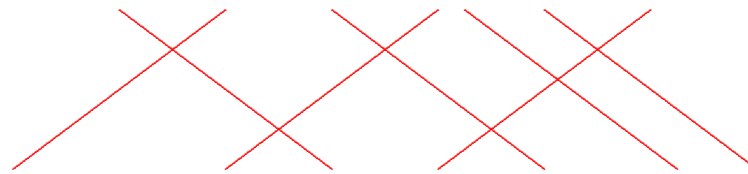

Intersection pattern dual to Dynkin diagram!

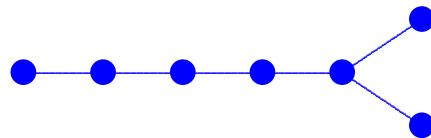

Resolutions of Klein Singularities:

\forall Klein singularity $V \subset \mathbb{C}^3$, $\exists!$ resolution

$$\hat{V} \rightarrow V$$

with $c_1(T^{1,0}\hat{V}) = 0$.

Replaces origin with a union of $\mathbb{C}P_1$'s,
each with self-intersection -2 ,
meeting transversely, & forming connected set:

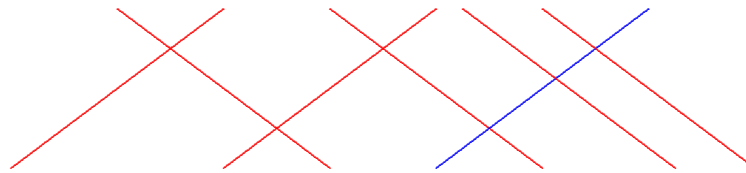

Intersection pattern dual to Dynkin diagram!

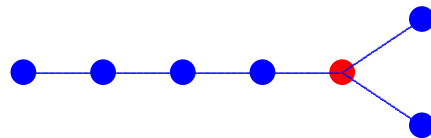

Resolutions of Klein Singularities:

\forall Klein singularity $V \subset \mathbb{C}^3$, $\exists!$ resolution

$$\hat{V} \rightarrow V$$

with $c_1(T^{1,0}\hat{V}) = 0$.

Replaces origin with a union of $\mathbb{C}\mathbb{P}_1$'s,
each with self-intersection -2 ,
meeting transversely, & forming connected set:

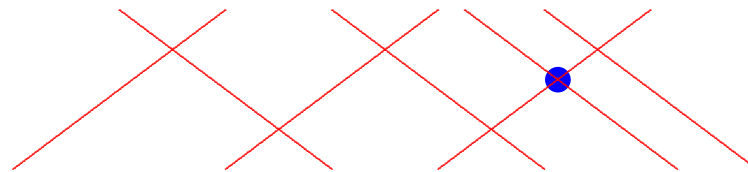

Intersection pattern dual to Dynkin diagram!

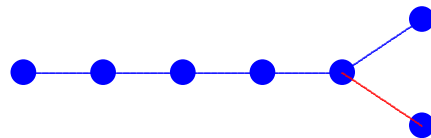

Resolutions of Klein Singularities:

\forall Klein singularity $V \subset \mathbb{C}^3$, $\exists!$ resolution

$$\hat{V} \rightarrow V$$

with $c_1(T^{1,0}\hat{V}) = 0$.

Replaces origin with a union of $\mathbb{C}P_1$'s,
each with self-intersection -2 ,
meeting transversely, & forming connected set:

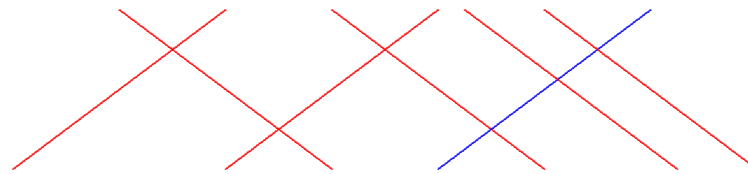

Intersection pattern dual to Dynkin diagram!

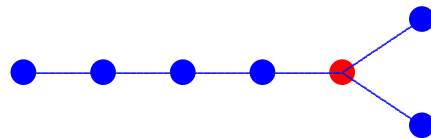

Resolutions of Klein Singularities:

\forall Klein singularity $V \subset \mathbb{C}^3$, $\exists!$ resolution

$$\hat{V} \rightarrow V$$

with $c_1(T^{1,0}\hat{V}) = 0$.

Replaces origin with a union of $\mathbb{C}\mathbb{P}_1$'s,
each with self-intersection -2 ,
meeting transversely, & forming connected set:

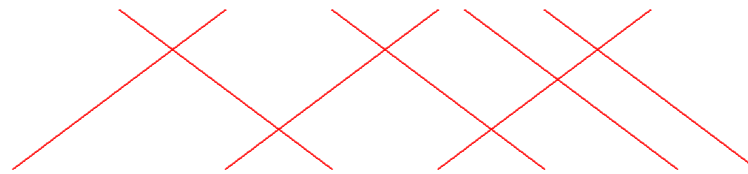

Intersection pattern dual to Dynkin diagram!

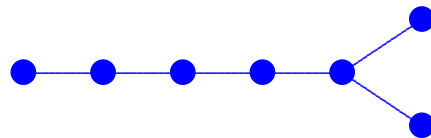

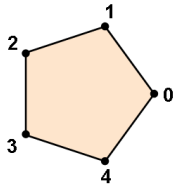

$$\mathbb{Z}_{k+1} \longleftrightarrow A_k$$



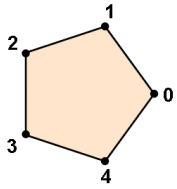

$$\mathbb{Z}_{k+1} \longleftrightarrow A_k$$

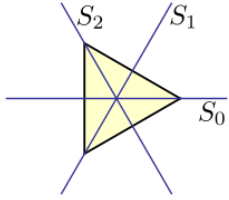

$$\text{Dih}_{k-2}^* \longleftrightarrow D_k$$

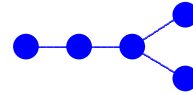

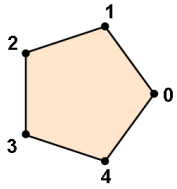

$$\mathbb{Z}_{k+1} \longleftrightarrow A_k$$

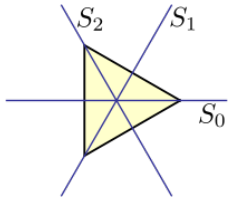

$$\text{Dih}_{k-2}^* \longleftrightarrow D_k$$

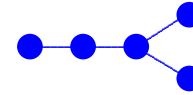

$$T^* \longleftrightarrow E_6$$

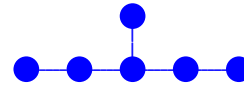

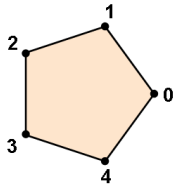

$$\mathbb{Z}_{k+1} \longleftrightarrow A_k$$

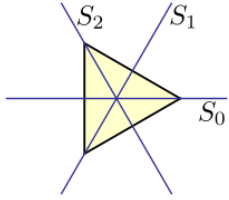

$$\text{Dih}_{k-2}^* \longleftrightarrow D_k$$

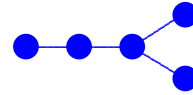

$$T^* \longleftrightarrow E_6$$

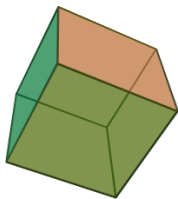
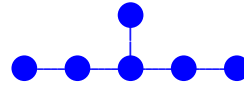

$$O^* \longleftrightarrow E_7$$

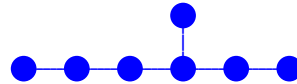

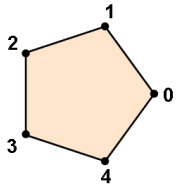

$$\mathbb{Z}_{k+1} \longleftrightarrow A_k$$

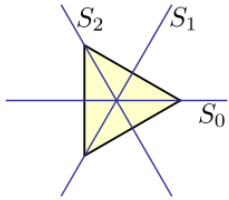

$$\text{Dih}_{k-2}^* \longleftrightarrow D_k$$

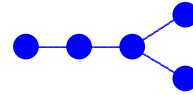

$$T^* \longleftrightarrow E_6$$

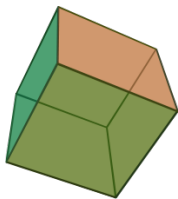
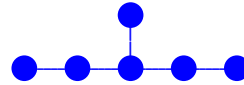

$$O^* \longleftrightarrow E_7$$

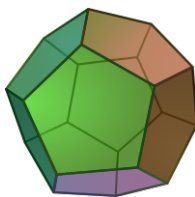
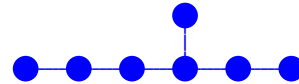

$$I^* \longleftrightarrow E_8$$



Key examples:

Term **ALE** coined by Gibbons & Hawking, 1979.

They wrote down various explicit **Ricci-flat ALE** 4-manifolds they called **gravitational instantons**.

Their examples have just one end, with

$$\Gamma \cong \mathbb{Z}_\ell \subset \mathbf{SU}(2) \subset \mathbf{O}(4).$$

The G-H metrics are **hyper-Kähler**, and were soon independently rediscovered by Hitchin.

Hitchin conjectured that similar metrics would exist for each finite $\Gamma \subset \mathbf{SU}(2)$.

Proved by Kronheimer, who also showed (1989) this gives **complete classification** of ALE hyper-Kählers.

Hyper-Kähler metrics:

(M^4, g) hyper-Kähler \iff holonomy $\subset \mathbf{Sp}(1)$

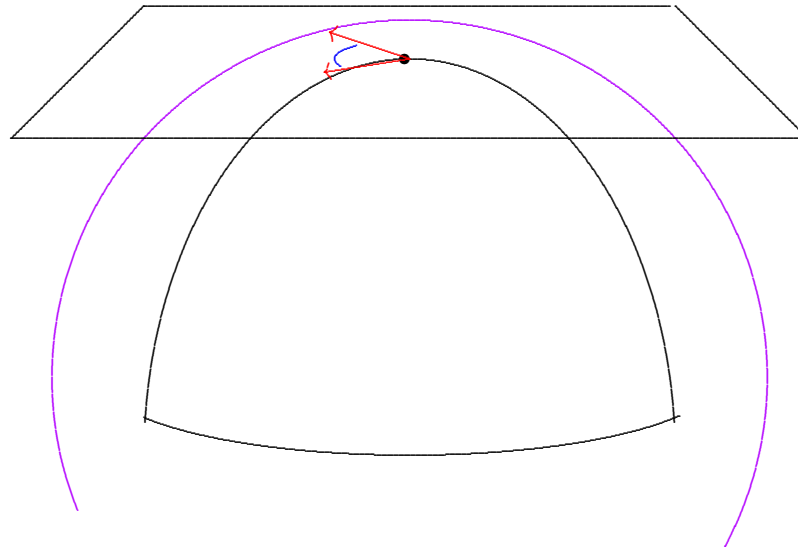

$$\mathbf{Sp}(1) = \mathbf{SU}(2)$$

Ricci-flat and Kähler,

for many different complex structures!

All these complex structures can be repackaged as

Penrose Twistor Space (Z^6, J) ,

which is a complex 3-manifold.

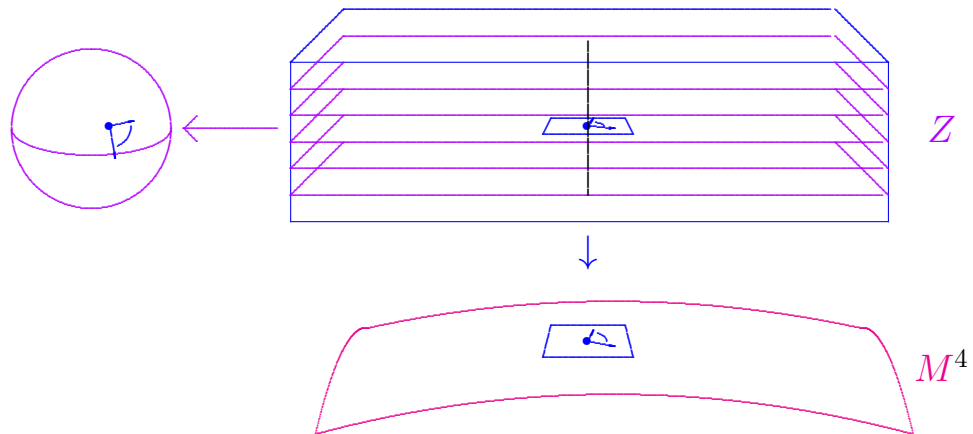

All these complex structures can be repackaged as

Penrose Twistor Space (Z^6, J) ,

which is a complex 3-manifold.

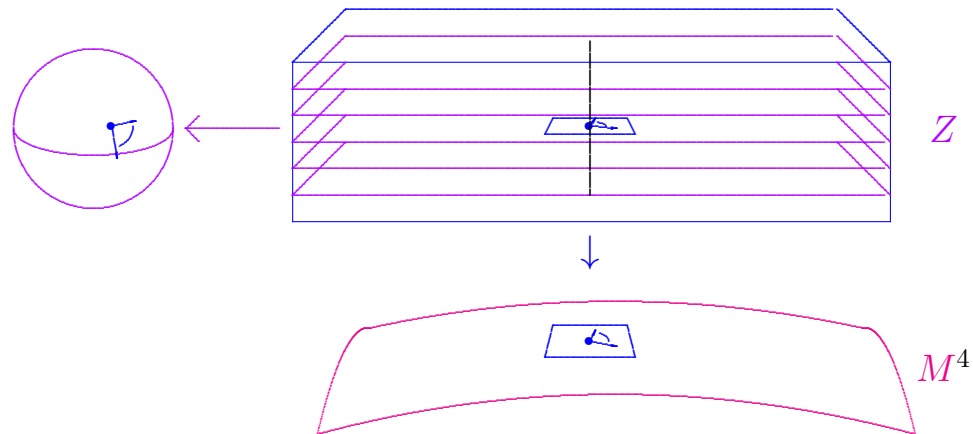

But similar for **scalar-flat Kähler surfaces** (M^4, g, J) !

Any scalar-flat Kähler surface (M^4, g, J) has a

Penrose Twistor Space (Z^6, J) ,

which is once again a complex 3-manifold.

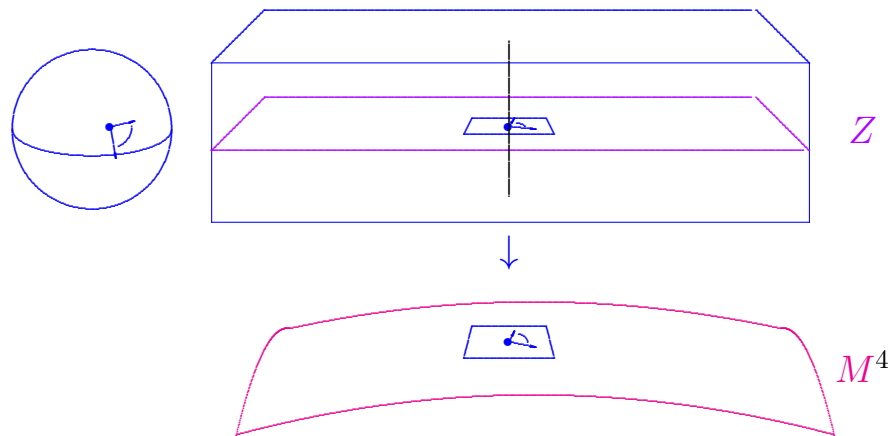

Any scalar-flat Kähler surface (M^4, g, J) has a

Penrose Twistor Space (Z^6, J) ,

which is once again a complex 3-manifold.

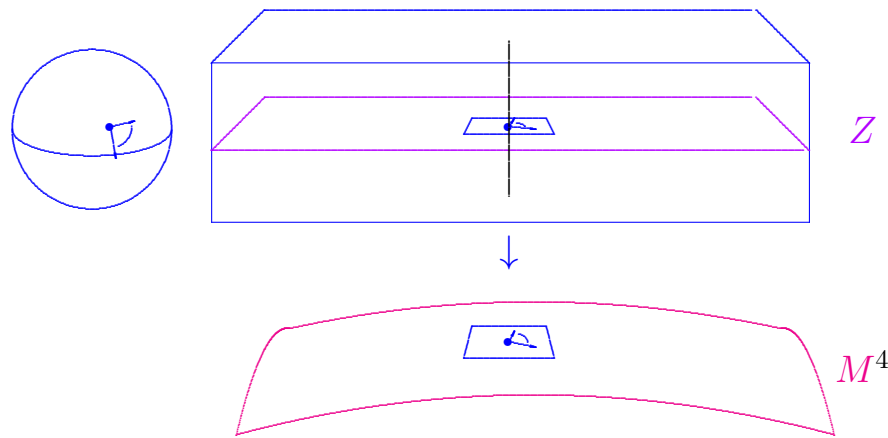

Integrability condition for twistor space: $W_+ \equiv 0$.

Any scalar-flat Kähler surface (M^4, g, J) has a

Penrose Twistor Space (Z^6, J) ,

which is once again a complex 3-manifold.

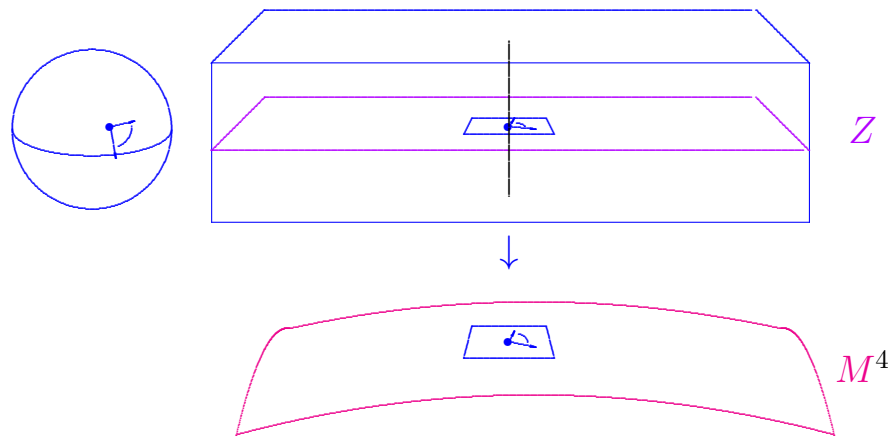

Integrability condition for twistor space: $W_+ \equiv 0$.

For Kähler surfaces, $|W_+|^2 = s^2/24$.

Any scalar-flat Kähler surface (M^4, g, J) has a

Penrose Twistor Space (Z^6, J) ,

which is once again a complex 3-manifold.

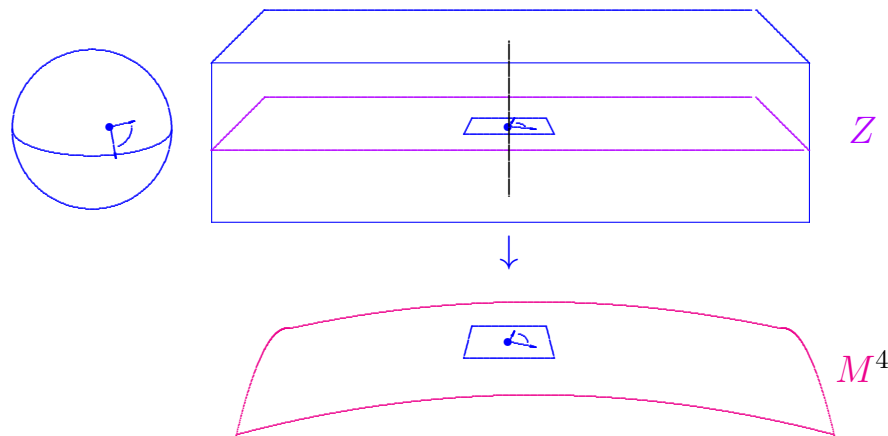

Integrability condition for twistor space: $W_+ \equiv 0$.

For Kähler surfaces, integrable \iff scalar-flat!

Any scalar-flat Kähler surface (M^4, g, J) has a

Penrose Twistor Space (Z^6, J) ,

which is once again a complex 3-manifold.

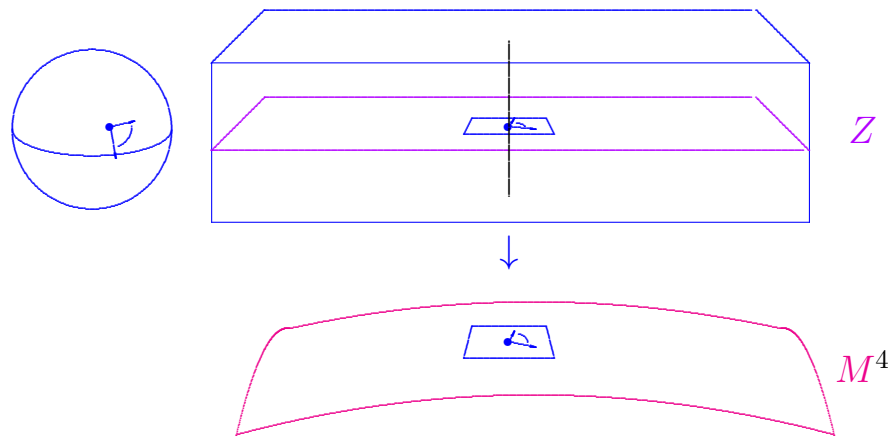

Integrability condition for twistor space: $W_+ \equiv 0$.

For Kähler surfaces, integrable \iff scalar-flat!

Leads to constructions of explicit examples.

Any scalar-flat Kähler surface (M^4, g, J) has a

Penrose Twistor Space (Z^6, J) ,

which is once again a complex 3-manifold.

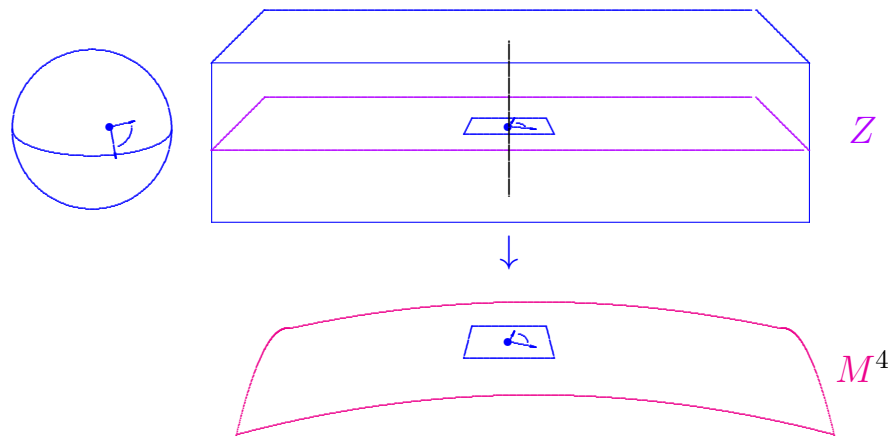

Integrability condition for twistor space: $W_+ \equiv 0$.

For Kähler surfaces, integrable \iff scalar-flat!

Many simple examples are AE or ALE.

Some AE Scalar-Flat Kähler Surfaces:

Some AE Scalar-Flat Kähler Surfaces:

(L '91)

Some AE Scalar-Flat Kähler Surfaces:

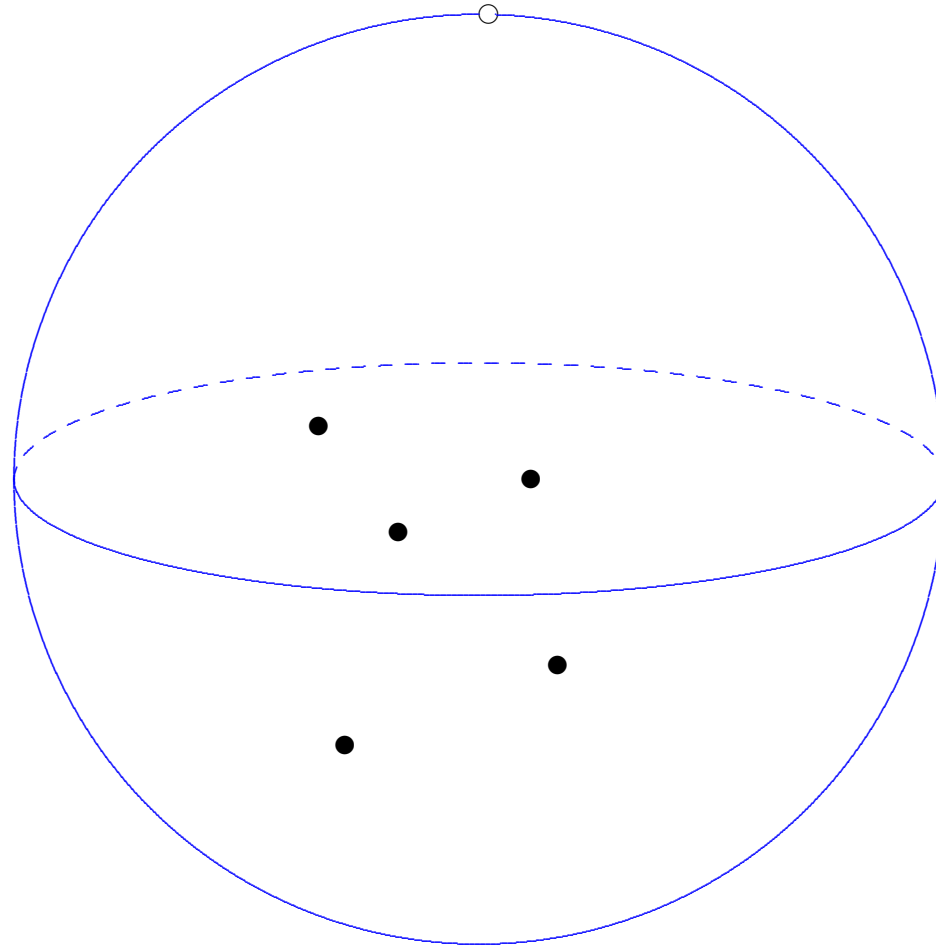

Some AE Scalar-Flat Kähler Surfaces:

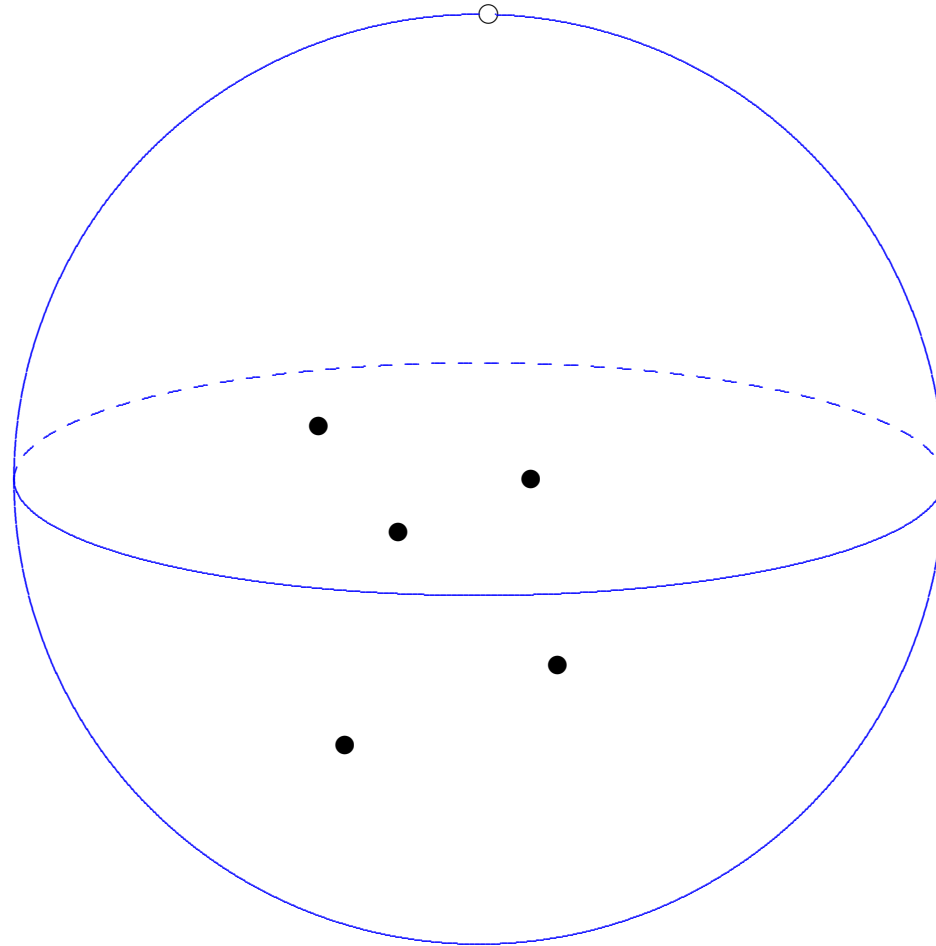

Data: k points in \mathcal{H}^3 and one point at infinity.

Some AE Scalar-Flat Kähler Surfaces:

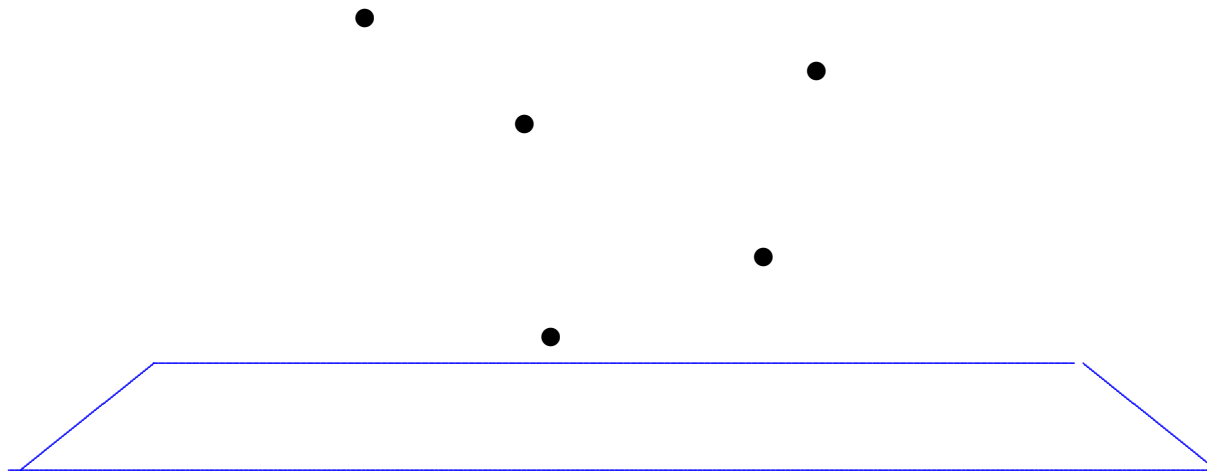

Data: k points in $\mathcal{H}^3 =$ upper half-space model.

Some AE Scalar-Flat Kähler Surfaces:

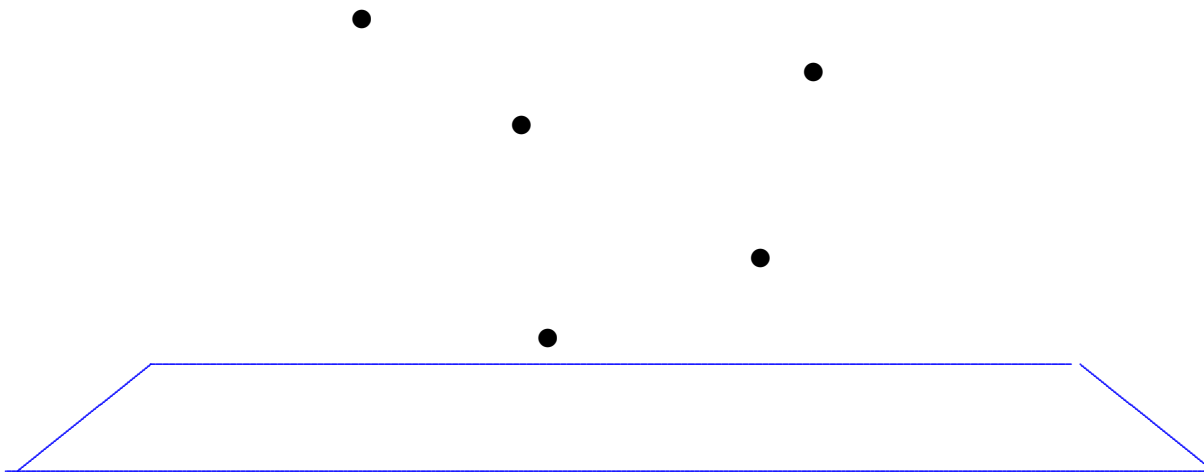

Data: k points in \mathcal{H}^3 . $\implies V$ with $\Delta V = 0$

$$V = 1 + \sum_{j=1}^k G_j$$

Some AE Scalar-Flat Kähler Surfaces:

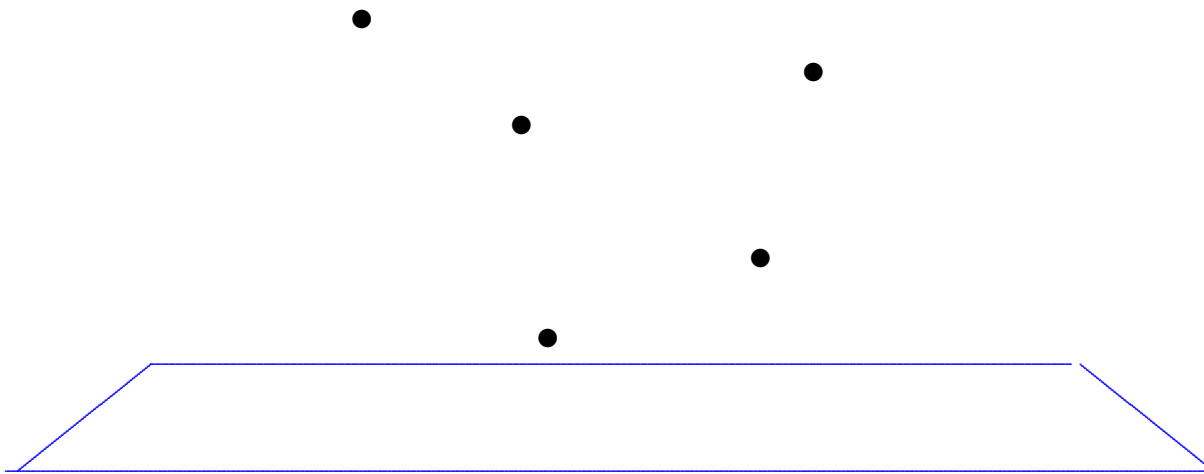

Data: k points in \mathcal{H}^3 . $\implies V$ with $\Delta V = 0$

$$V = 1 + \sum_{j=1}^k \frac{1}{e^{2\rho_j} - 1}$$

Some AE Scalar-Flat Kähler Surfaces:

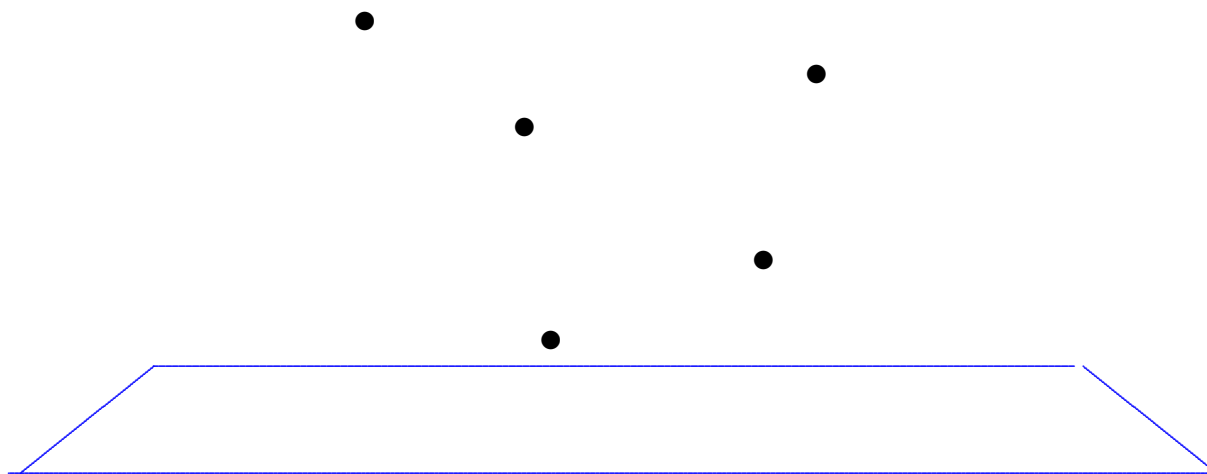

Data: k points in \mathcal{H}^3 . $\implies V$ with $\Delta V = 0$

$$V = 1 + \sum_{j=1}^k G_j$$

Some AE Scalar-Flat Kähler Surfaces:

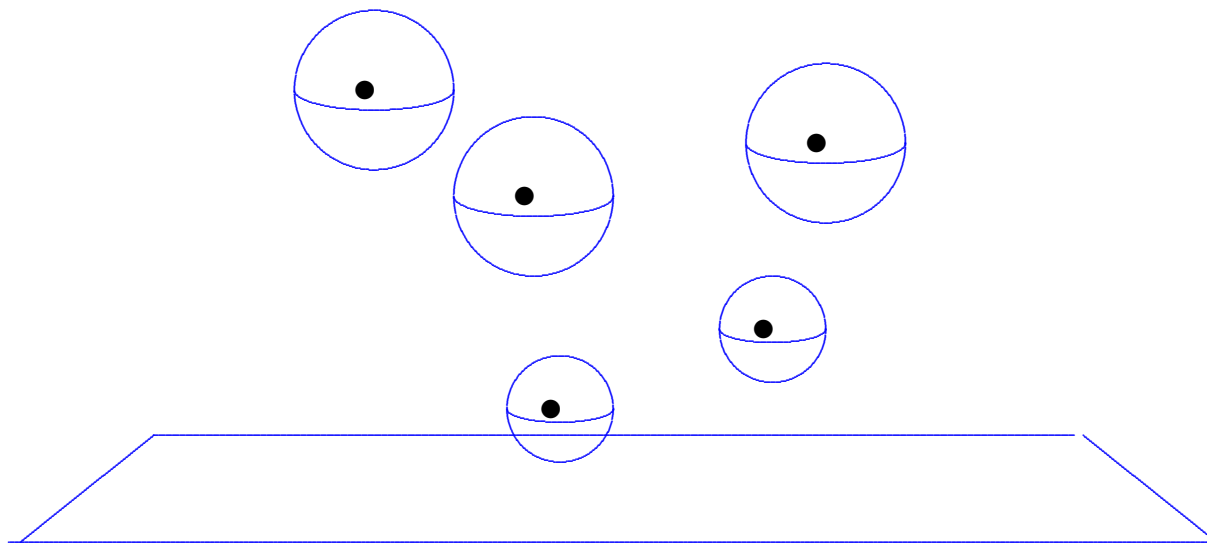

Data: k points in \mathcal{H}^3 . $\implies V$ with $\Delta V = 0$

$F = \star dV$ curvature θ on $P \rightarrow \mathcal{H}^3 - \{\text{pts}\}$.

Some AE Scalar-Flat Kähler Surfaces:

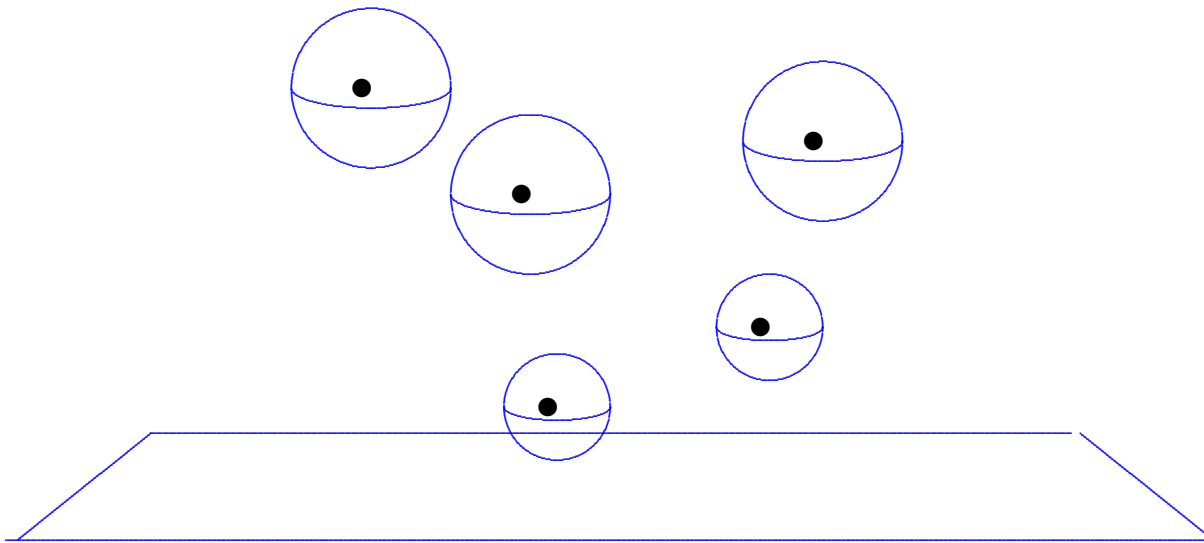

Data: k points in \mathcal{H}^3 . $\implies V$ with $\Delta V = 0$

$$g = z^2 \left(V h + V^{-1} \theta^2 \right)$$

Some AE Scalar-Flat Kähler Surfaces:

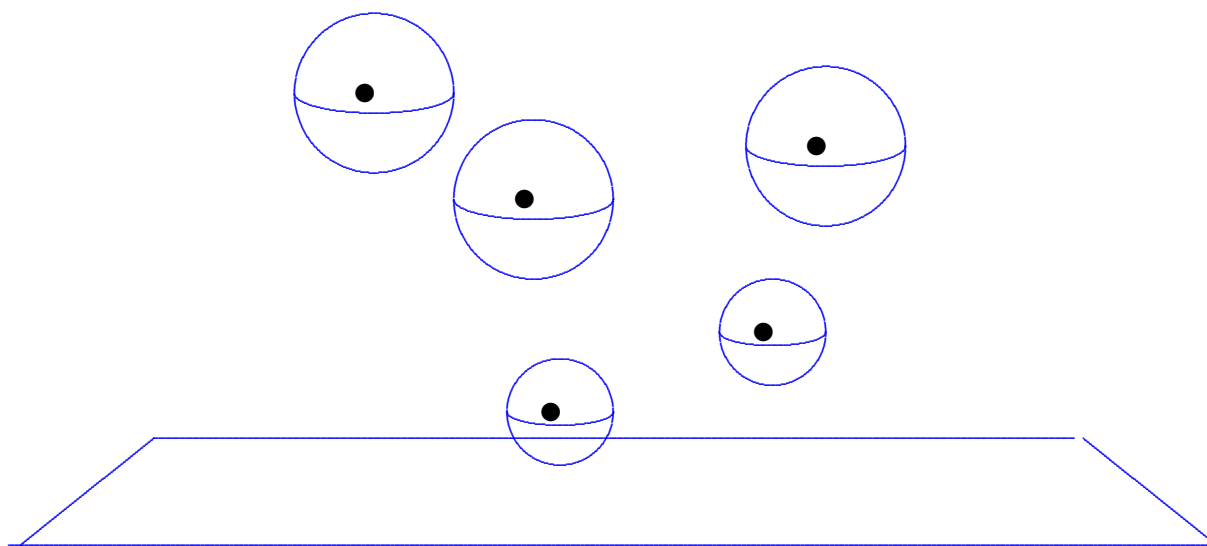

Data: k points in \mathcal{H}^3 . $\implies V$ with $\Delta V = 0$

$$g = z^2 \left(V \frac{dx^2 + dy^2 + dz^2}{z^2} + V^{-1} \theta^2 \right)$$

Some AE Scalar-Flat Kähler Surfaces:

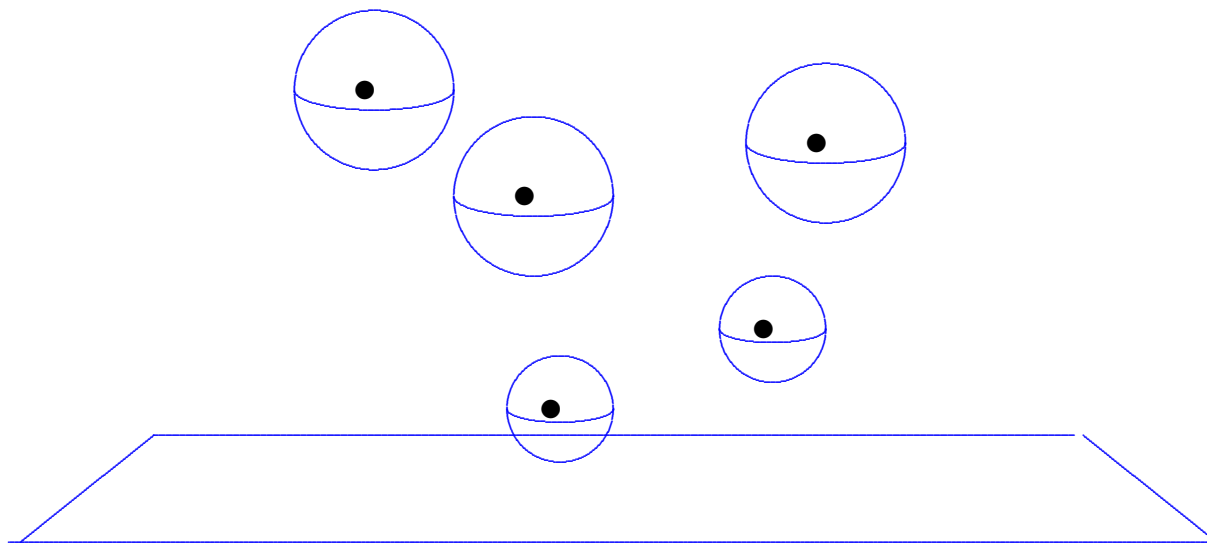

Data: k points in \mathcal{H}^3 . $\implies V$ with $\Delta V = 0$

$$g = V(dx^2 + dy^2 + dz^2) + z^2 V^{-1} \theta^2$$

Some AE Scalar-Flat Kähler Surfaces:

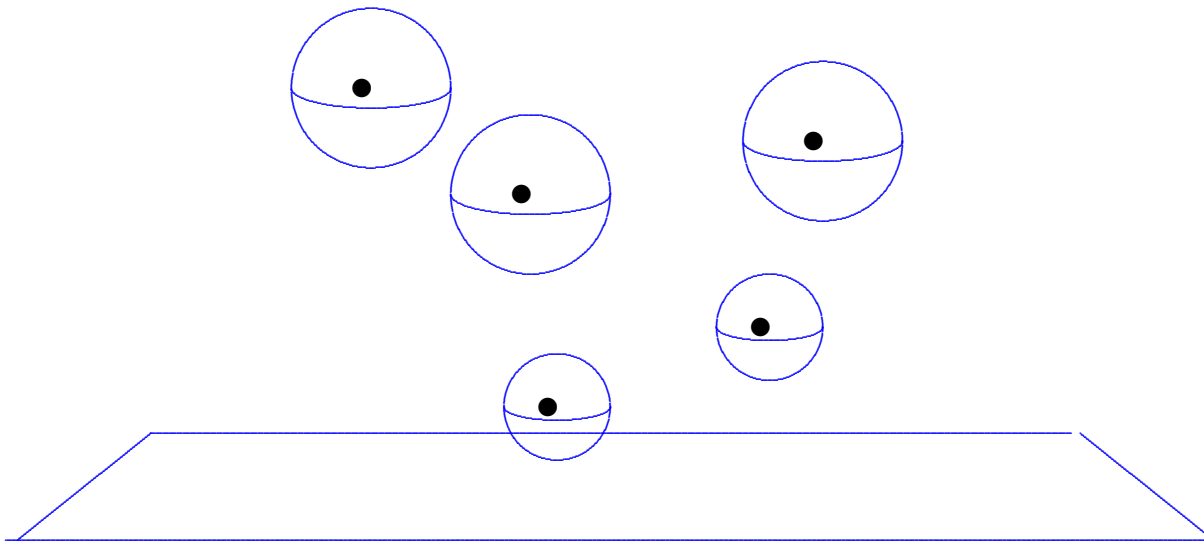

Data: k points in \mathcal{H}^3 . $\implies V$ with $\Delta V = 0$

$$g = z^2 \left(V h + V^{-1} \theta^2 \right)$$

Some AE Scalar-Flat Kähler Surfaces:

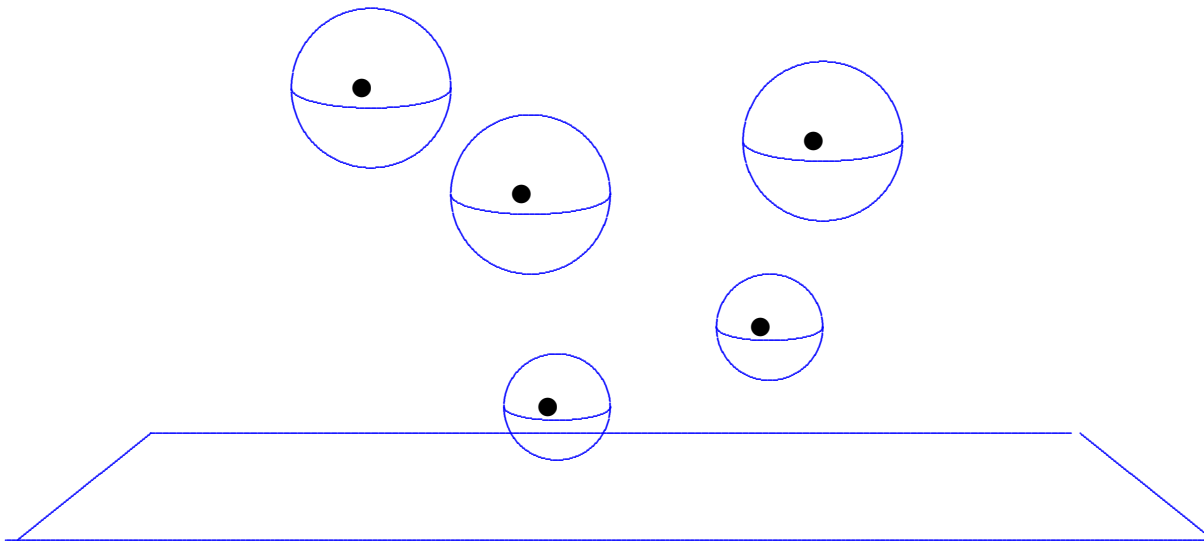

Riemannian completion is AE scalar-flat Kähler.

$$g = z^2 \left(Vh + V^{-1}\theta^2 \right)$$

Some AE Scalar-Flat Kähler Surfaces:

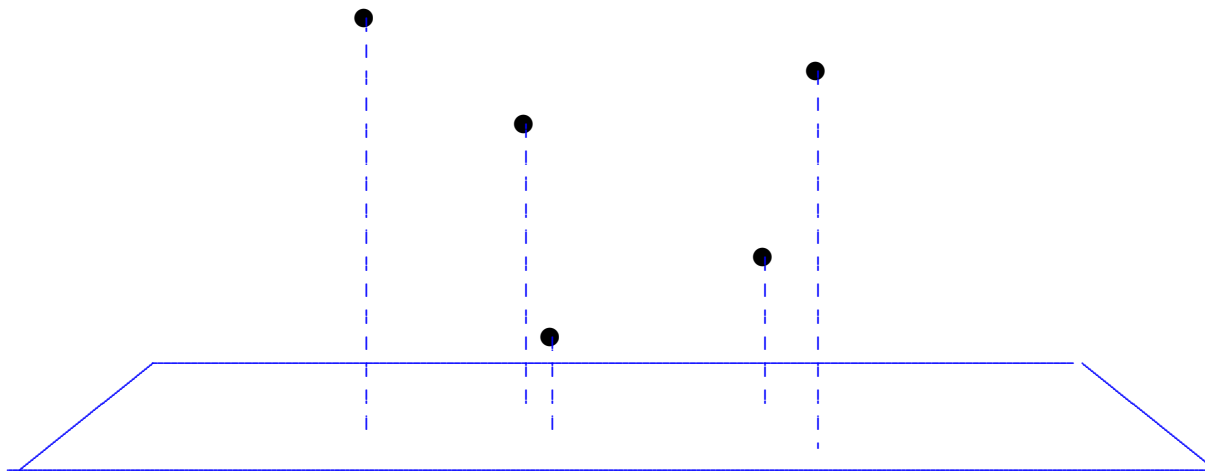

Data: k points in \mathcal{H}^3 . $\implies V$ with $\Delta V = 0$

$$g = z^2 \left(Vh + V^{-1}\theta^2 \right)$$

Some AE Scalar-Flat Kähler Surfaces:

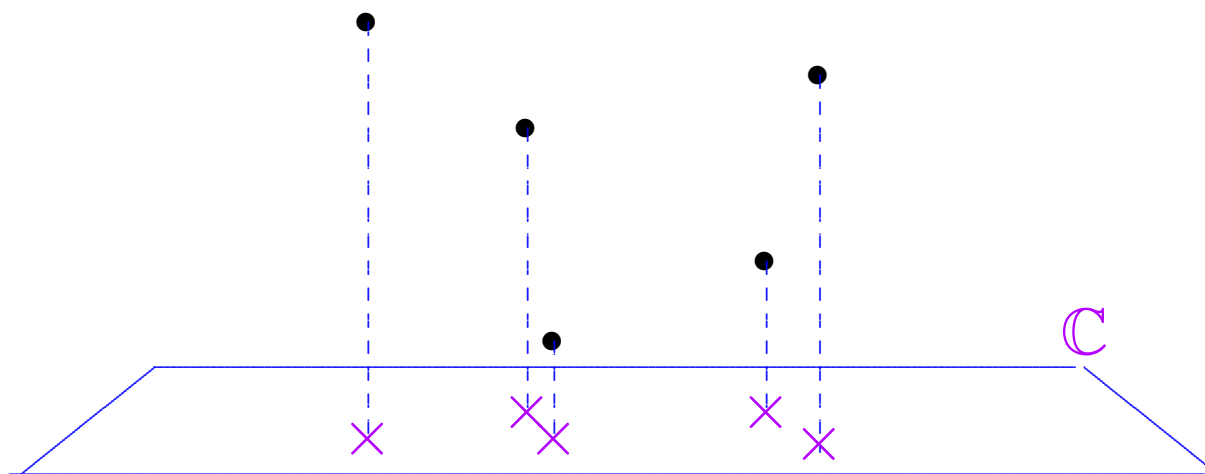

Data: k points in \mathcal{H}^3 . $\implies V$ with $\Delta V = 0$

$$g = z^2 \left(Vh + V^{-1}\theta^2 \right)$$

Some AE Scalar-Flat Kähler Surfaces:

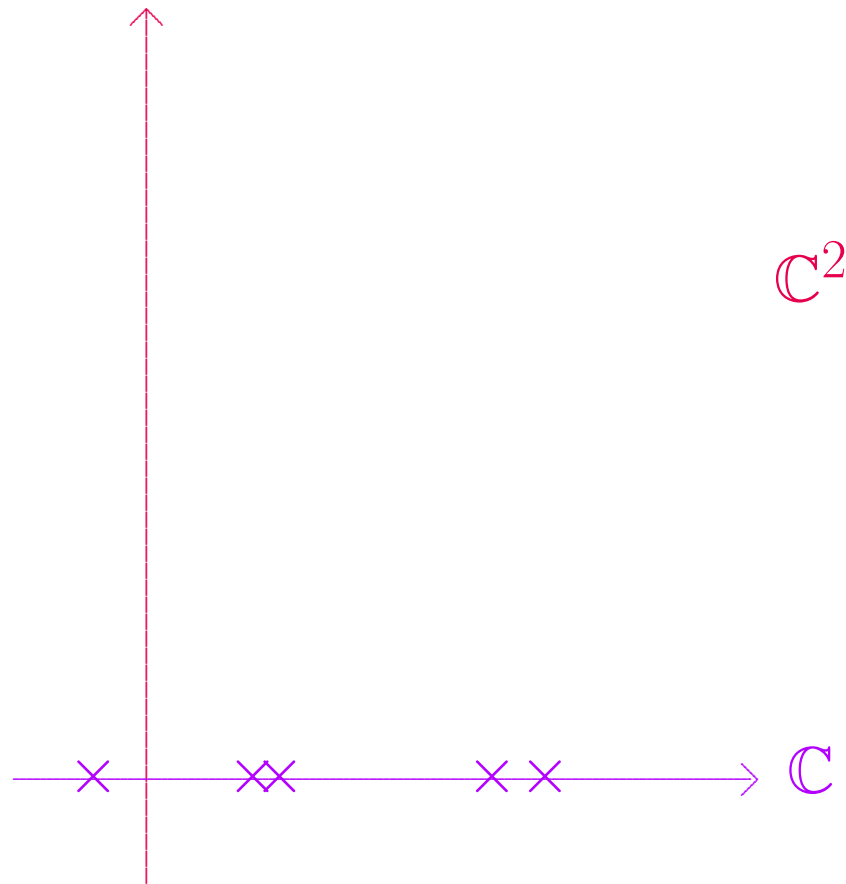

Data: k points in \mathcal{H}^3 . $\implies V$ with $\Delta V = 0$

$$g = z^2 \left(Vh + V^{-1}\theta^2 \right)$$

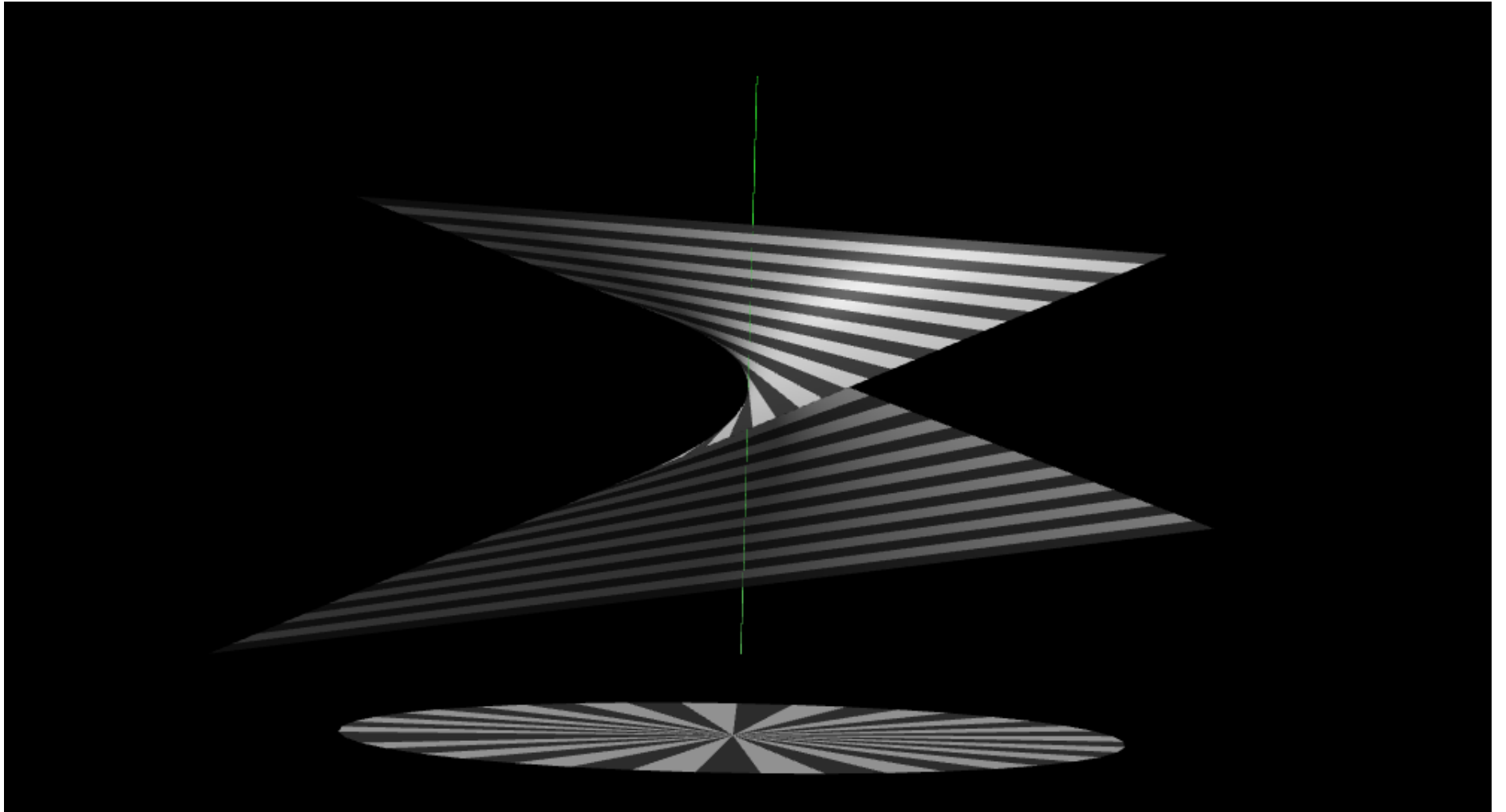

Some AE Scalar-Flat Kähler Surfaces:

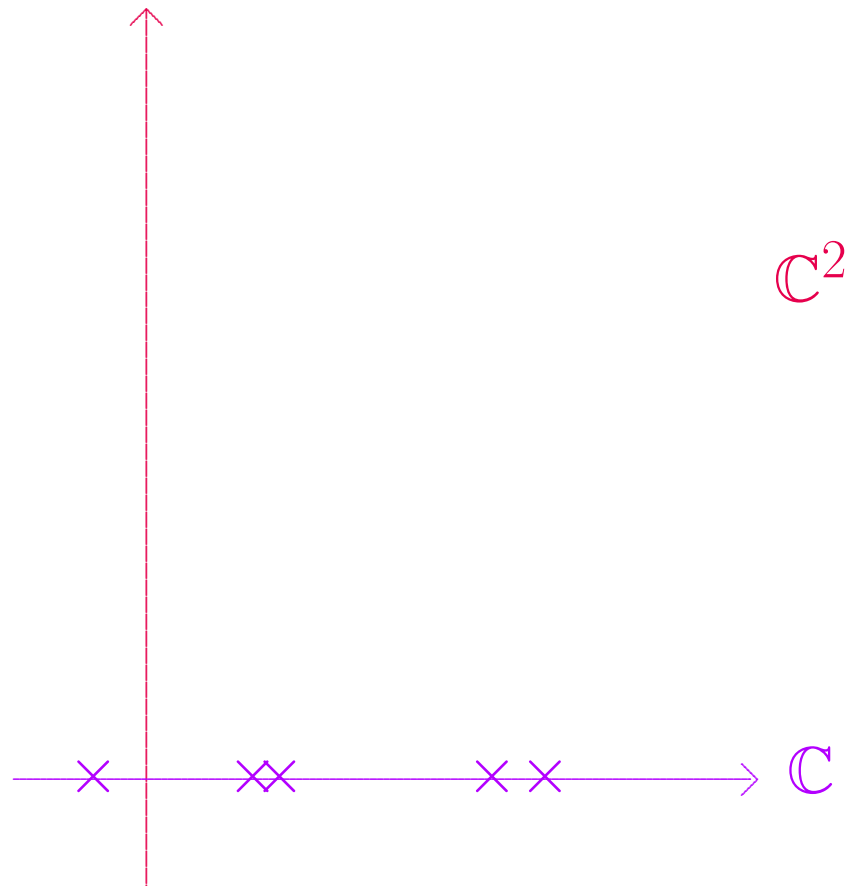

Data: k points in \mathcal{H}^3 . $\implies V$ with $\Delta V = 0$

$$g = z^2 \left(V h + V^{-1} \theta^2 \right)$$

Some AE Scalar-Flat Kähler Surfaces:

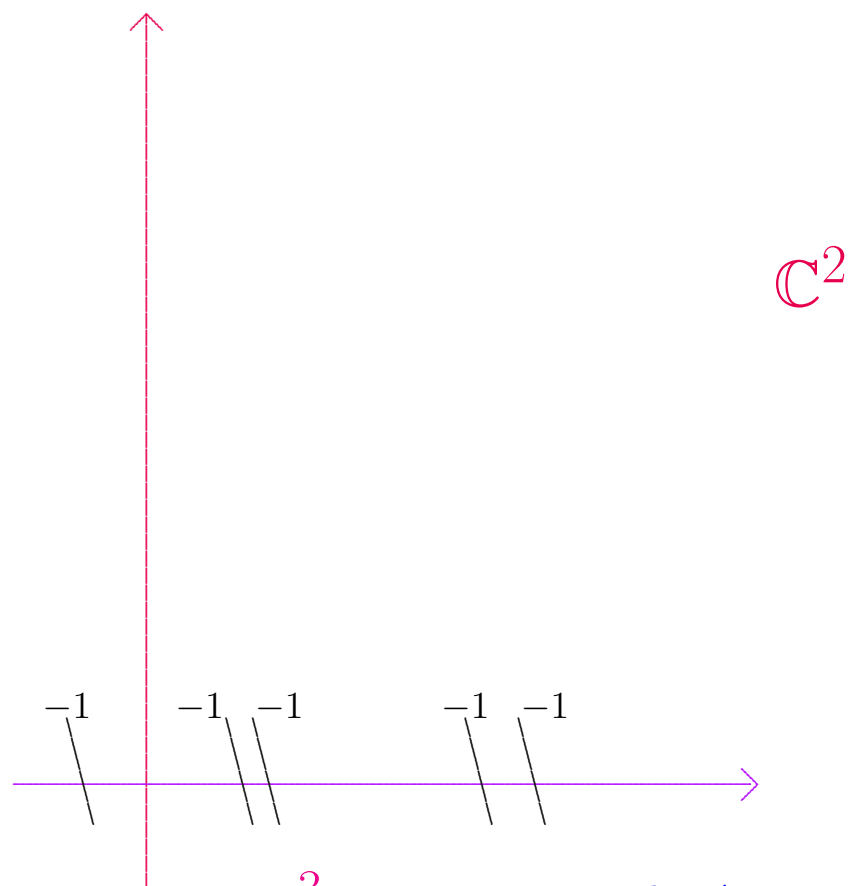

Data: k points in \mathcal{H}^3 . $\implies V$ with $\Delta V = 0$

$$g = z^2 \left(Vh + V^{-1}\theta^2 \right)$$

Some AE Scalar-Flat Kähler Surfaces:

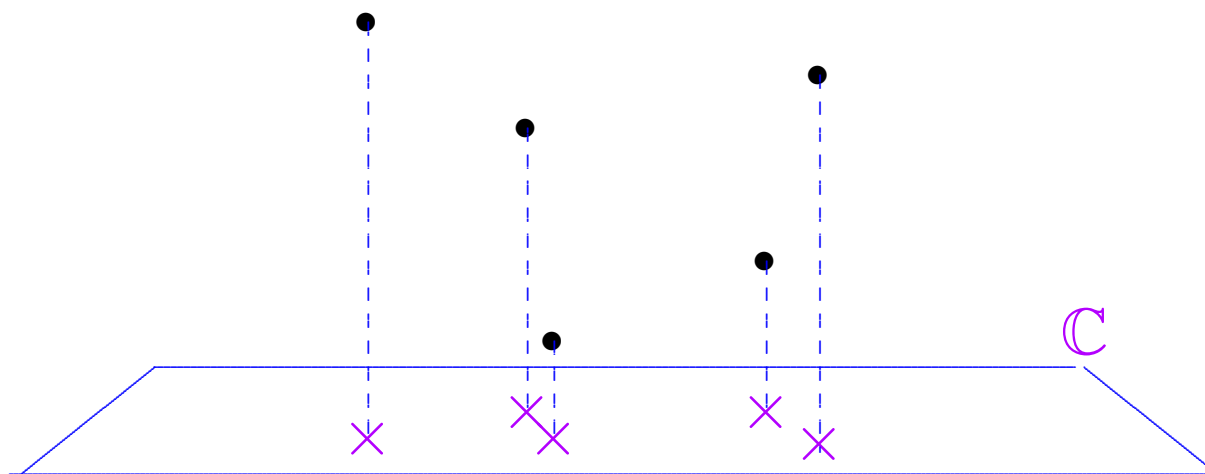

Data: k points in \mathcal{H}^3 . $\implies V$ with $\Delta V = 0$

$$g = z^2 \left(Vh + V^{-1}\theta^2 \right)$$

Some AE Scalar-Flat Kähler Surfaces:

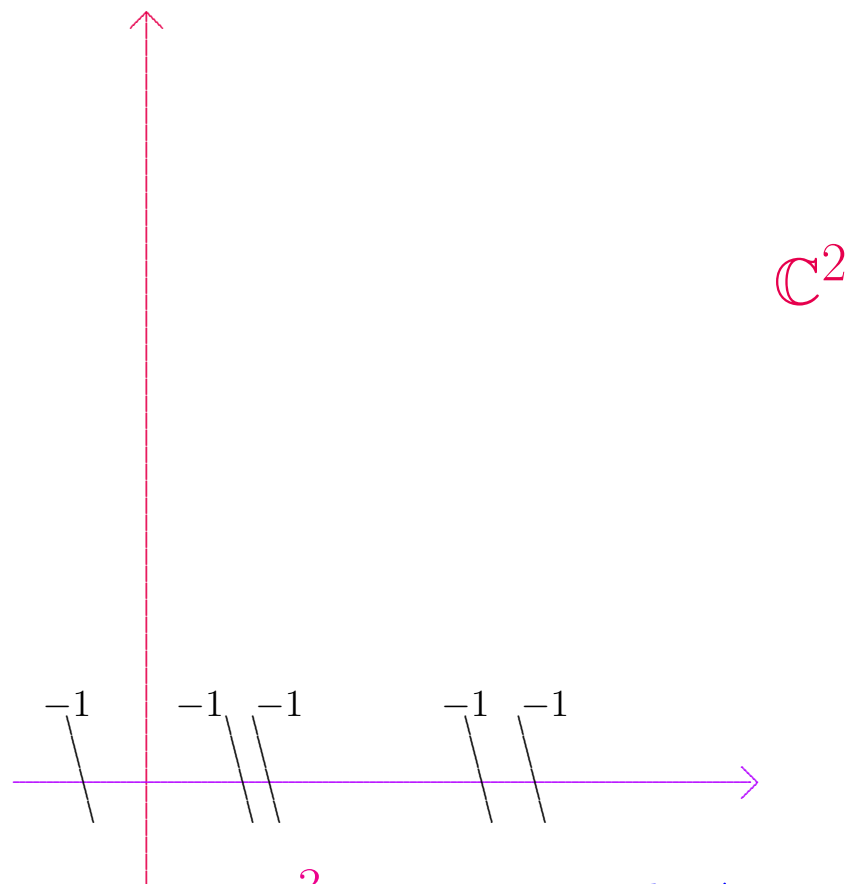

Data: k points in \mathcal{H}^3 . $\implies V$ with $\Delta V = 0$

$$g = z^2 \left(Vh + V^{-1}\theta^2 \right)$$

Some ALE Scalar-Flat Kähler Surfaces:

Some ALE Scalar-Flat Kähler Surfaces:

(L '91)

Some ALE Scalar-Flat Kähler Surfaces:

Some ALE Scalar-Flat Kähler Surfaces:

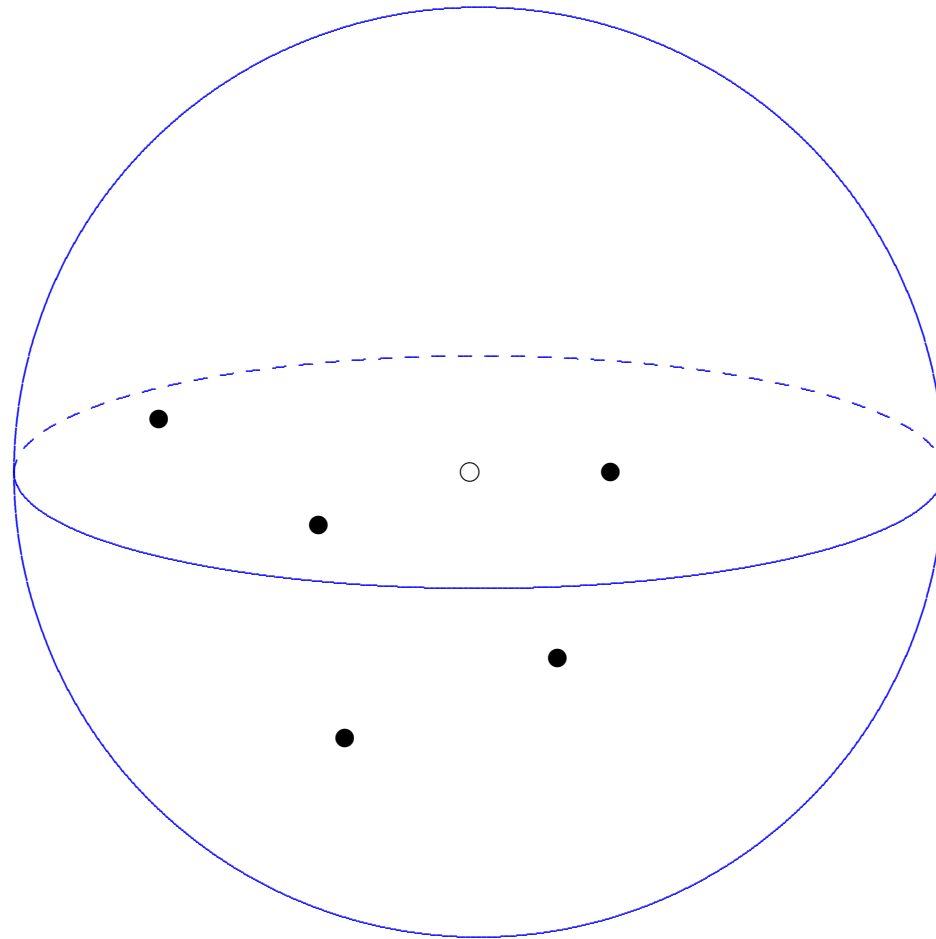

Data: $k + 1$ points in \mathcal{H}^3 .

Some ALE Scalar-Flat Kähler Surfaces:

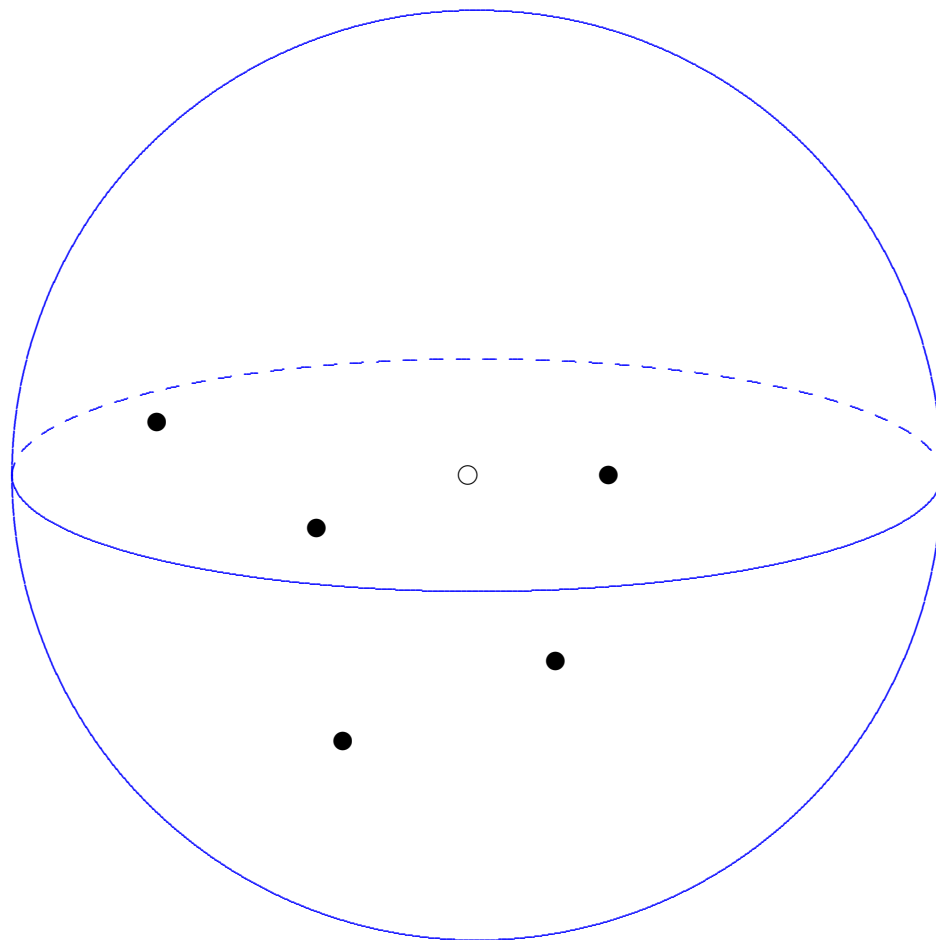

Data: $k + 1$ points in \mathcal{H}^3 . $\implies V$ with $\Delta V = 0$

$$V = 1 + \ell G_0 + \sum_{j=1}^k G_j$$

Some ALE Scalar-Flat Kähler Surfaces:

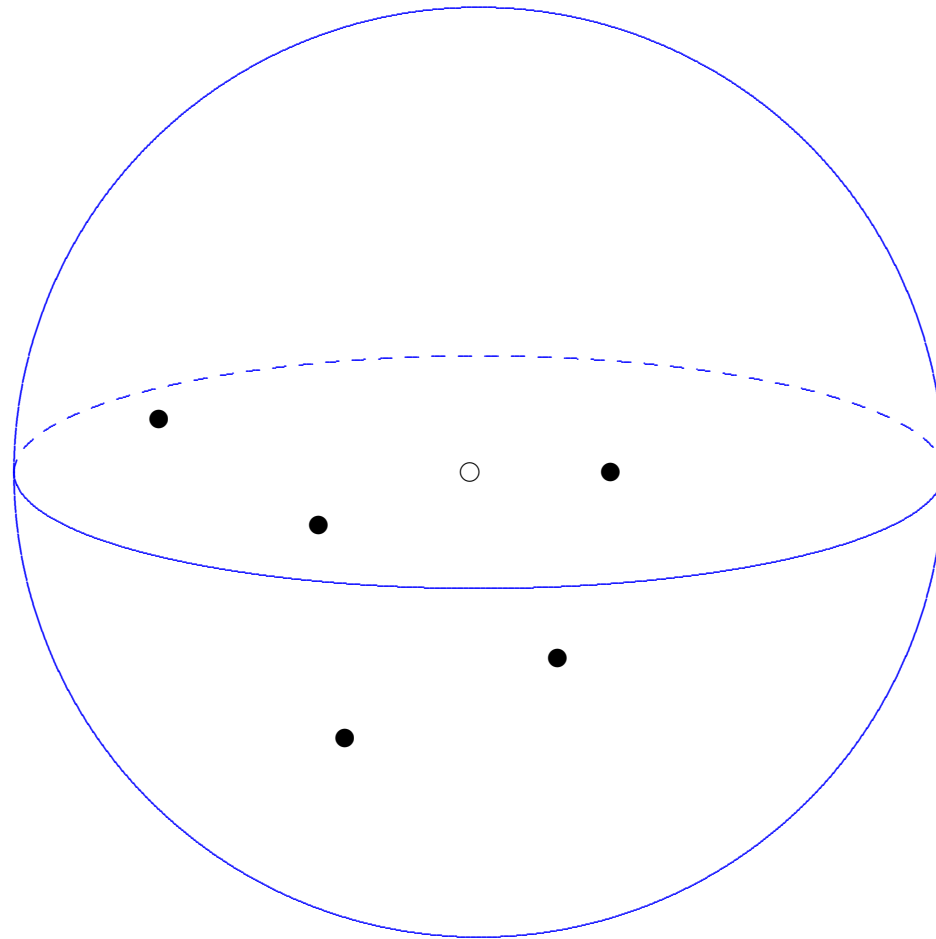

Data: $k + 1$ points in \mathcal{H}^3 . $\implies V$ with $\Delta V = 0$

$$V = 1 + \frac{\ell}{e^{2\varrho_0} - 1} + \sum_{j=1}^k \frac{1}{e^{2\varrho_j} - 1}$$

Some ALE Scalar-Flat Kähler Surfaces:

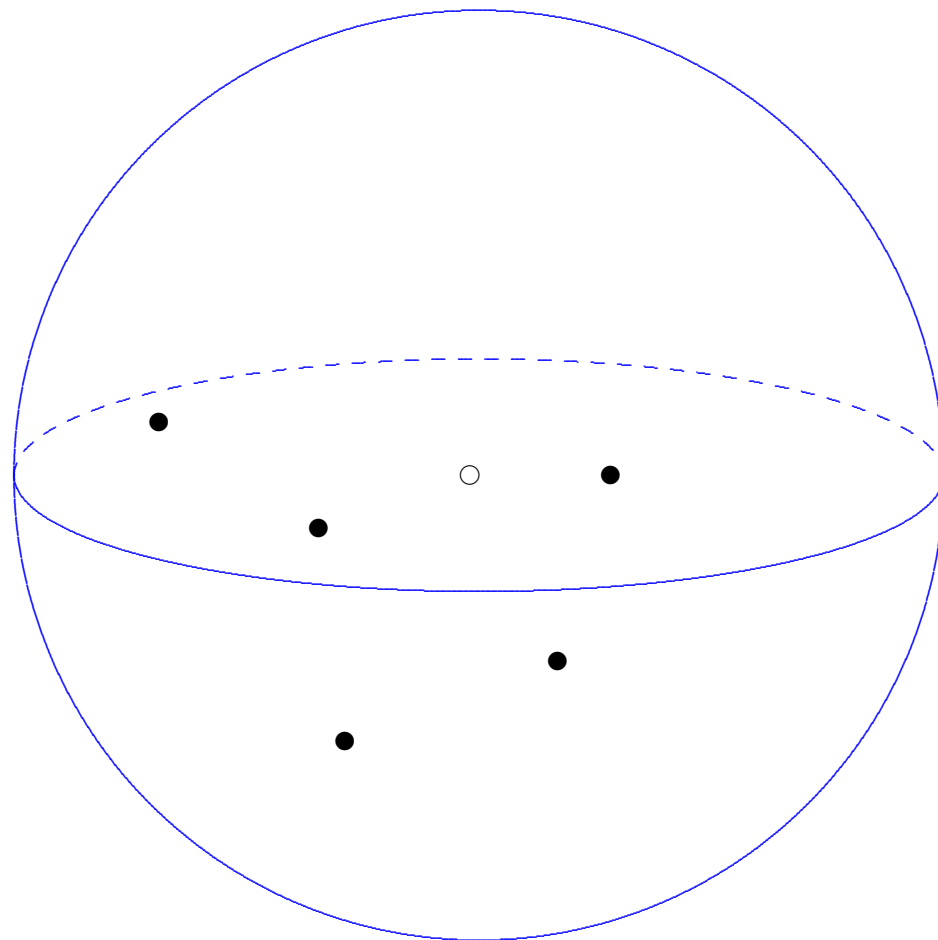

Data: $k + 1$ points in \mathcal{H}^3 . $\implies V$ with $\Delta V = 0$

$$V = 1 + \ell G_0 + \sum_{j=1}^k G_j$$

Some ALE Scalar-Flat Kähler Surfaces:

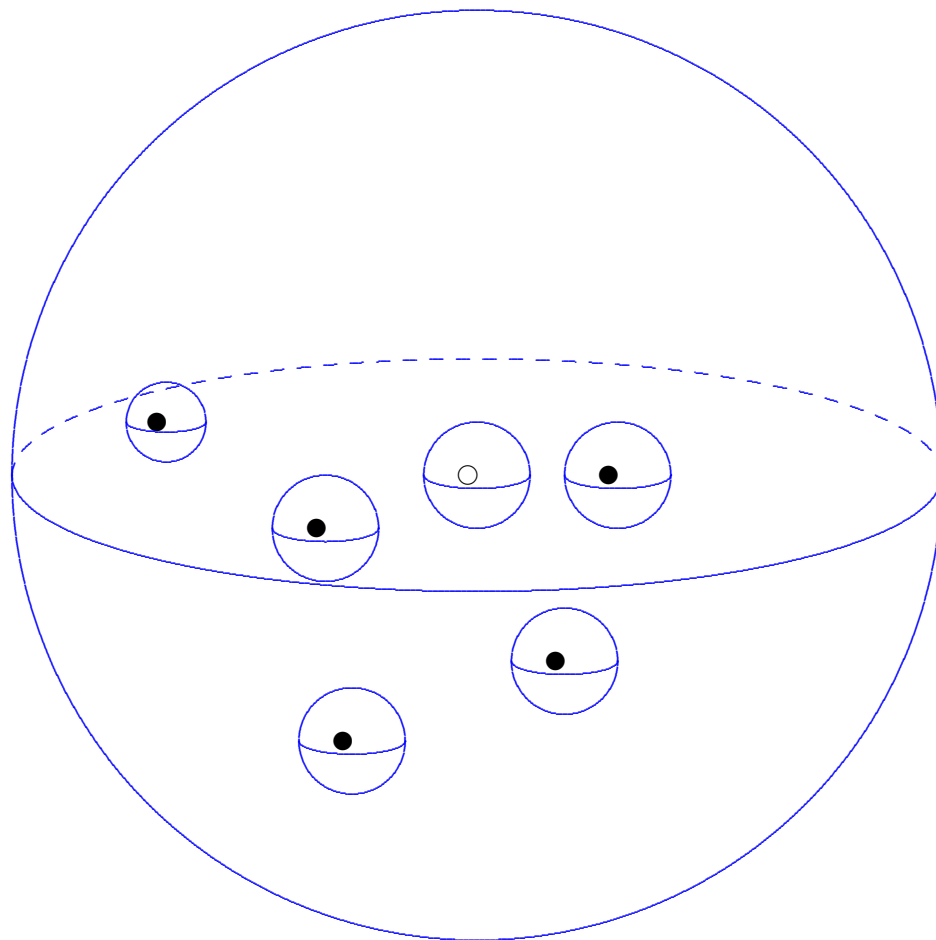

Data: $k + 1$ points in \mathcal{H}^3 . $\implies V$ with $\Delta V = 0$

$F = \star dV$ curvature θ on $P \rightarrow \mathcal{H}^3 - \{\text{pts}\}$.

Some ALE Scalar-Flat Kähler Surfaces:

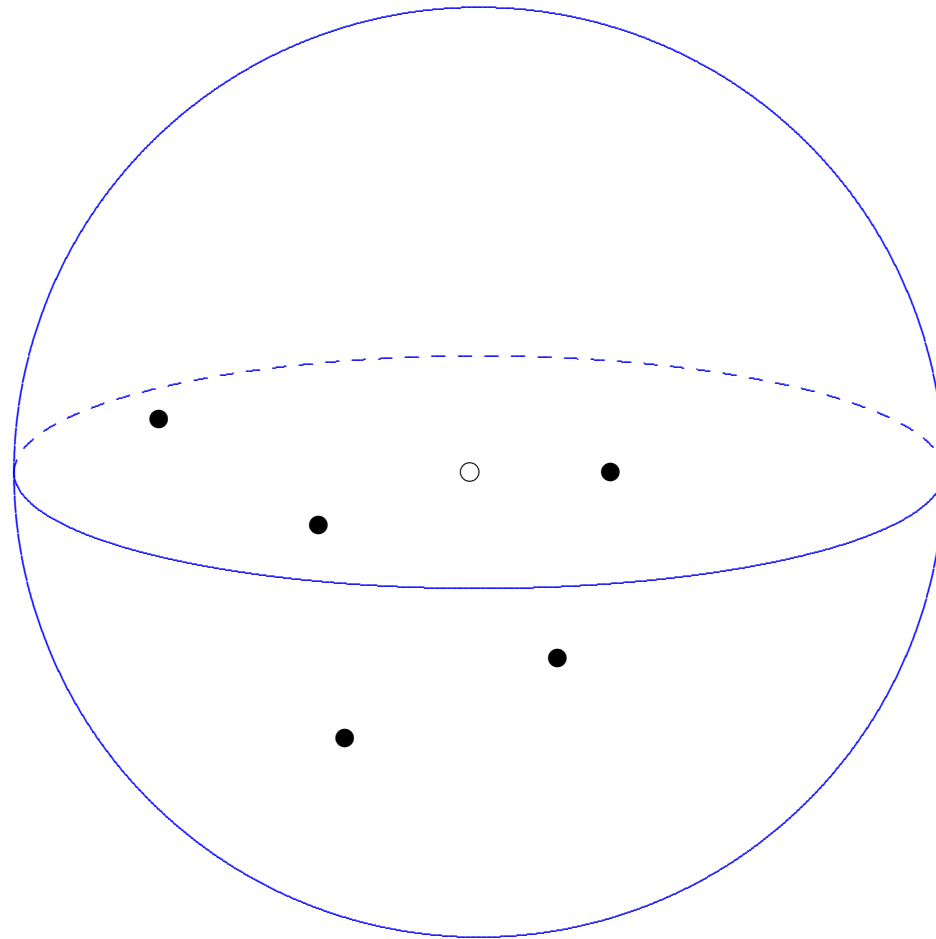

Data: $k + 1$ points in \mathcal{H}^3 . $\implies V$ with $\Delta V = 0$

$$g = \frac{1}{4 \sinh^2 \varrho_0} \left(V h + V^{-1} \theta^2 \right)$$

Some ALE Scalar-Flat Kähler Surfaces:

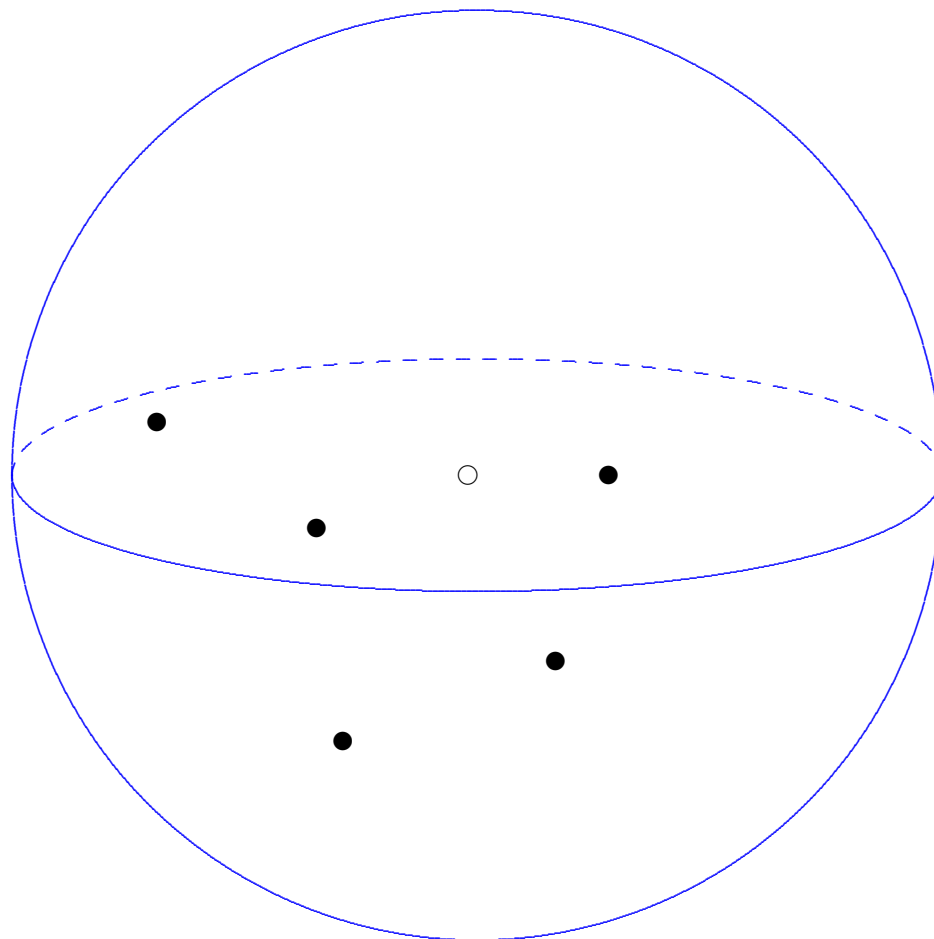

Riemannian completion is **ALE** scalar-flat Kähler.

$$g = \frac{1}{4 \sinh^2 \varrho_0} \left(V h + V^{-1} \theta^2 \right)$$

Some ALE Scalar-Flat Kähler Surfaces:

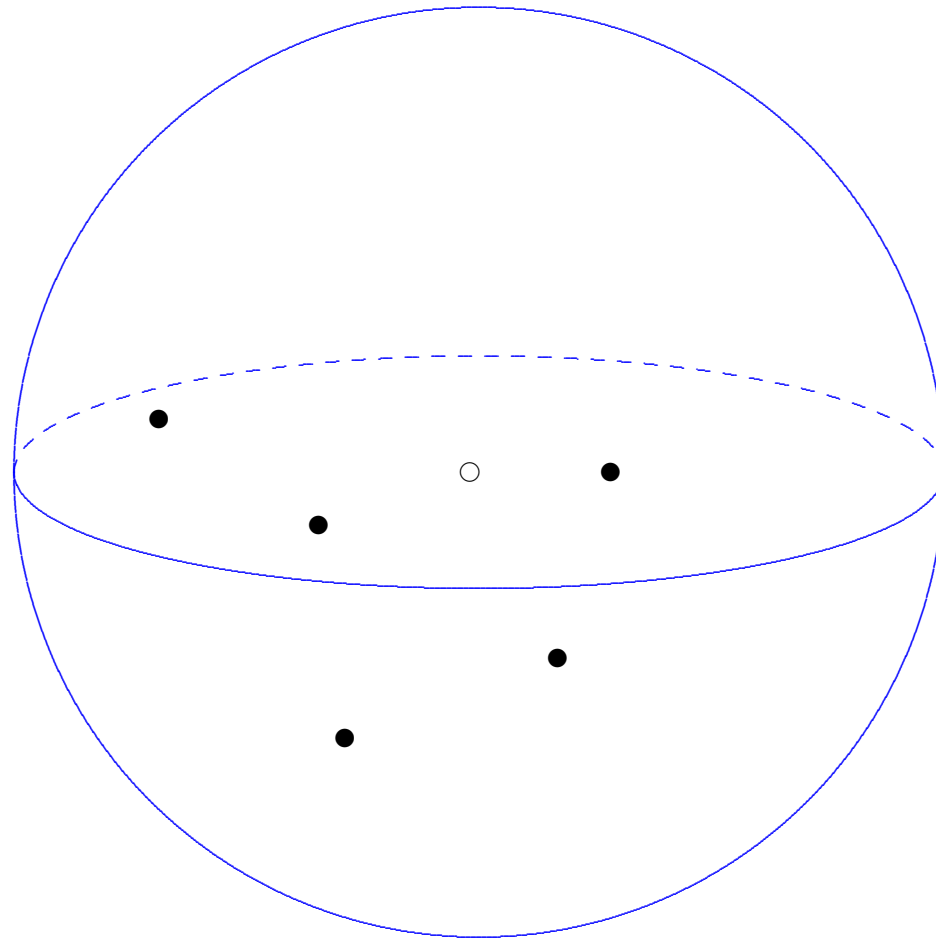

Riemannian completion is ALE with $\Gamma = \mathbb{Z}_\ell$.

$$V = 1 + \frac{\ell}{e^{2\varrho_0} - 1} + \sum_{j=1}^k \frac{1}{e^{2\varrho_j} - 1}$$

Some ALE Scalar-Flat Kähler Surfaces:

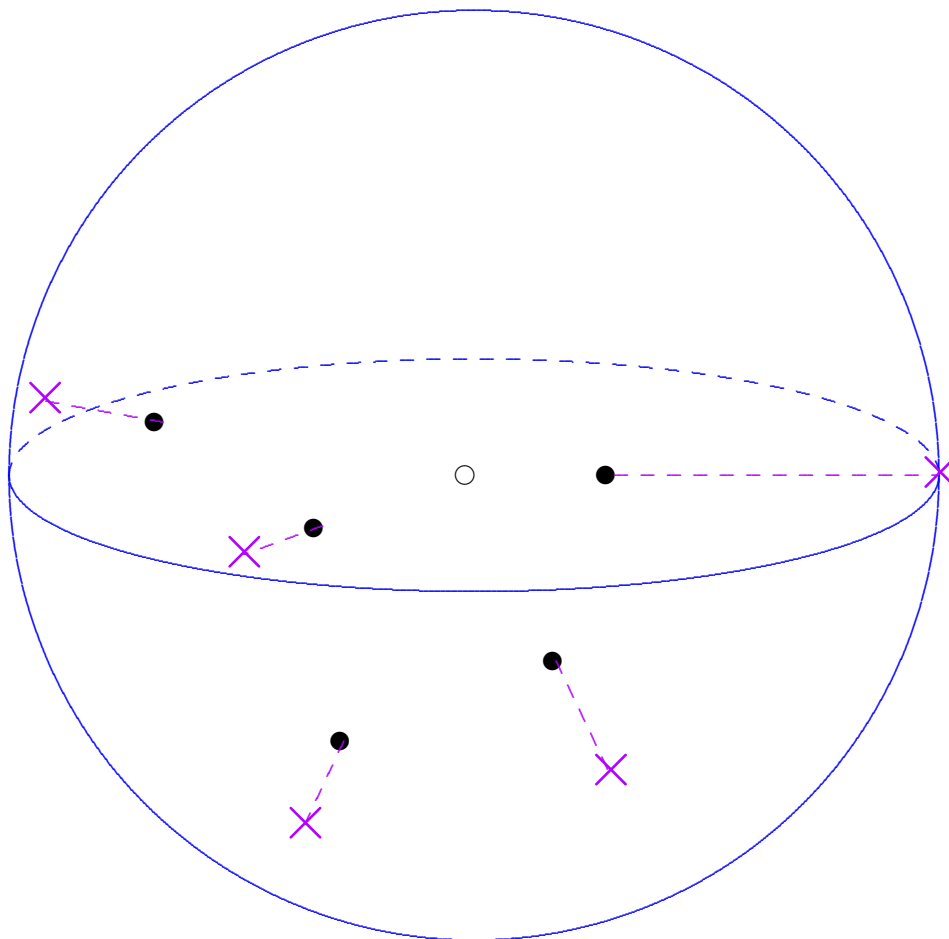

Riemannian completion is **ALE** with $\Gamma = \mathbb{Z}_\ell$.

$$V = 1 + \frac{\ell}{e^{2\varrho_0} - 1} + \sum_{j=1}^k \frac{1}{e^{2\varrho_j} - 1}$$

Some ALE Scalar-Flat Kähler Surfaces:

Blow up of Chern-class $-\ell$ line bundle over $\mathbb{C}P_1$ at k points on zero section Σ .

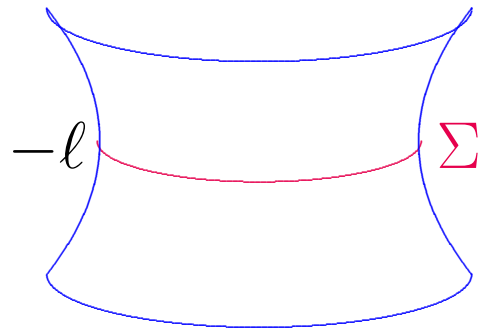

Riemannian completion is ALE with $\Gamma = \mathbb{Z}_\ell$.

$$V = 1 + \frac{\ell}{e^{2\rho_0} - 1} + \sum_{j=1}^k \frac{1}{e^{2\rho_j} - 1}$$

Some ALE Scalar-Flat Kähler Surfaces:

Blow up of Chern-class $-\ell$ line bundle over $\mathbb{C}P_1$ at k points on zero section Σ .

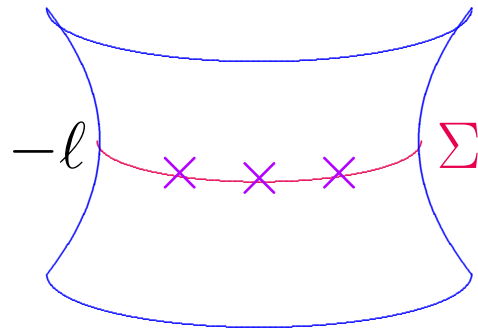

Riemannian completion is ALE with $\Gamma = \mathbb{Z}_\ell$.

$$V = 1 + \frac{\ell}{e^{2\varrho_0} - 1} + \sum_{j=1}^k \frac{1}{e^{2\varrho_j} - 1}$$

Some ALE Scalar-Flat Kähler Surfaces:

Blow up of Chern-class $-\ell$ line bundle over $\mathbb{C}P_1$ at k points on zero section Σ .

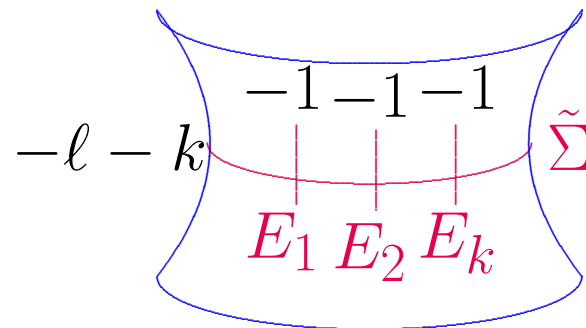

Riemannian completion is ALE with $\Gamma = \mathbb{Z}_\ell$.

$$V = 1 + \frac{\ell}{e^{2\varrho_0} - 1} + \sum_{j=1}^k \frac{1}{e^{2\varrho_j} - 1}$$

Any scalar-flat Kähler surface (M^4, g, J) has a

Penrose Twistor Space (Z, J) ,

which is once again a complex 3-manifold.

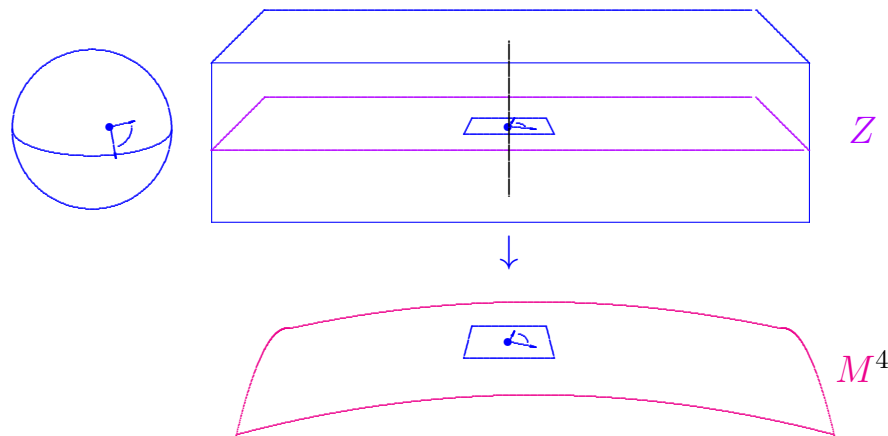

Twistor Spaces for These Metrics:

$$H^0(\mathbb{CP}_1 \times \mathbb{CP}_1, \mathcal{O}(1, 1)) = \mathbb{C}^4$$

Twistor Spaces for These Metrics:

$$H^0(\mathbb{CP}_1 \times \mathbb{CP}_1, \mathcal{O}(1, 1)) = \mathbb{C}^4 \supset \mathbb{R}^{1,3}$$

Twistor Spaces for These Metrics:

$$H^0(\mathbb{CP}_1 \times \mathbb{CP}_1, \mathcal{O}(1, 1)) = \mathbb{C}^4 \supset \mathbb{R}^{1,3} \supset \mathcal{H}^3$$

Twistor Spaces for These Metrics:

$$H^0(\mathbb{C}\mathbb{P}_1 \times \mathbb{C}\mathbb{P}_1, \mathcal{O}(1, 1)) = \mathbb{C}^4 \supset \mathbb{R}^{1,3} \supset \mathcal{H}^3$$

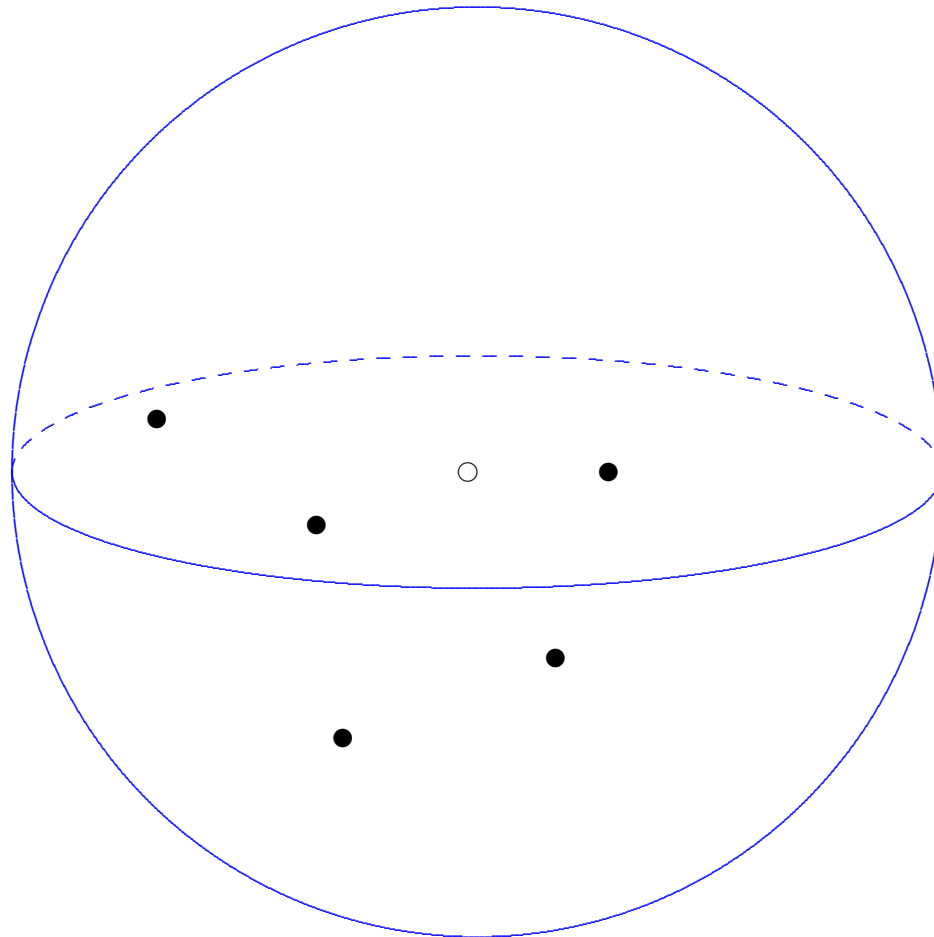

So $k + 1$ points in \mathcal{H}^3 give rise to

Twistor Spaces for These Metrics:

$$H^0(\mathbb{CP}_1 \times \mathbb{CP}_1, \mathcal{O}(1, 1)) = \mathbb{C}^4 \supset \mathbb{R}^{1,3} \supset \mathcal{H}^3$$

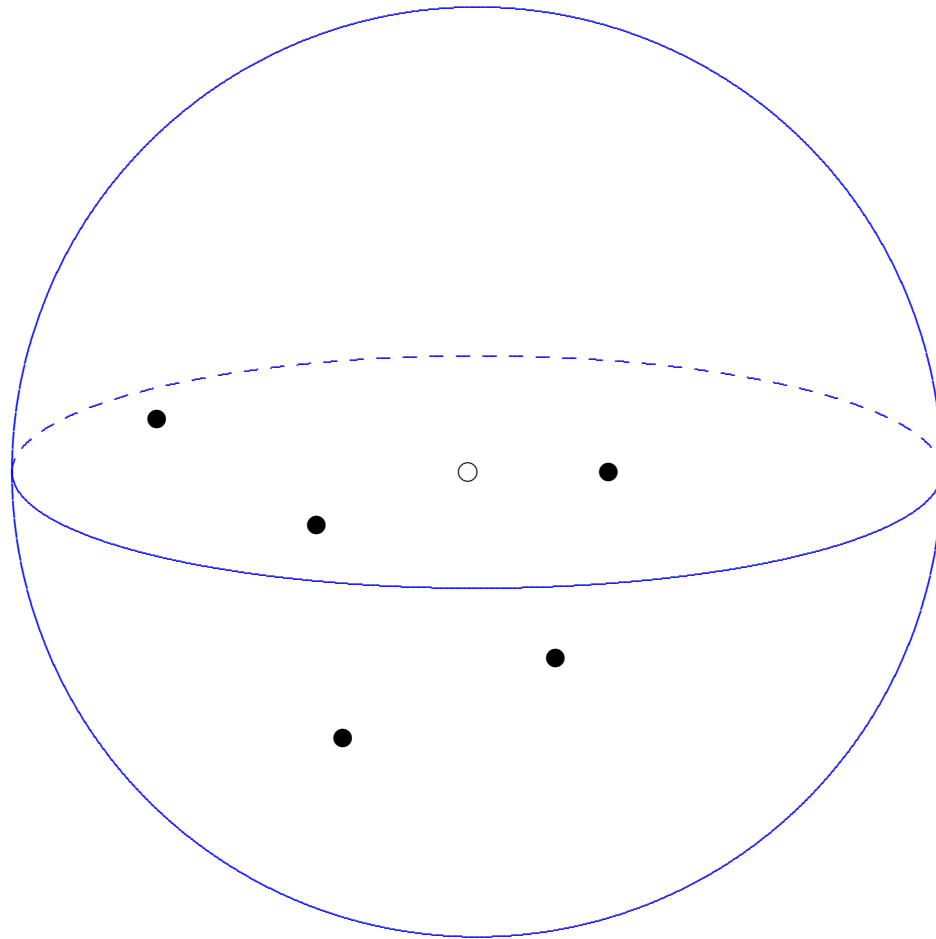

So $k + 1$ points in \mathcal{H}^3 give rise to

$$P_0, P_1, \dots, P_k \in H^0(\mathbb{CP}_1 \times \mathbb{CP}_1, \mathcal{O}(1, 1)).$$

Twistor Spaces for These Metrics:

$$H^0(\mathbb{CP}_1 \times \mathbb{CP}_1, \mathcal{O}(1, 1)) = \mathbb{C}^4 \supset \mathbb{R}^{1,3} \supset \mathcal{H}^3$$

Twistor Spaces for These Metrics:

$$H^0(\mathbb{CP}_1 \times \mathbb{CP}_1, \mathcal{O}(1, 1)) = \mathbb{C}^4 \supset \mathbb{R}^{1,3} \supset \mathcal{H}^3$$

$$\text{In } \mathcal{O}(k + \ell - 1, 1) \oplus \mathcal{O}(1, k + \ell - 1) \rightarrow \mathbb{CP}_1 \times \mathbb{CP}_1,$$

Twistor Spaces for These Metrics:

$$H^0(\mathbb{CP}_1 \times \mathbb{CP}_1, \mathcal{O}(1, 1)) = \mathbb{C}^4 \supset \mathbb{R}^{1,3} \supset \mathcal{H}^3$$

In $\mathcal{O}(k + \ell - 1, 1) \oplus \mathcal{O}(1, k + \ell - 1) \rightarrow \mathbb{CP}_1 \times \mathbb{CP}_1$,

let \tilde{Z} be the hypersurface

$$xy = P_0^\ell P_1 \cdots P_k.$$

Twistor Spaces for These Metrics:

$$H^0(\mathbb{CP}_1 \times \mathbb{CP}_1, \mathcal{O}(1, 1)) = \mathbb{C}^4 \supset \mathbb{R}^{1,3} \supset \mathcal{H}^3$$

In $\mathcal{O}(k + \ell - 1, 1) \oplus \mathcal{O}(1, k + \ell - 1) \rightarrow \mathbb{CP}_1 \times \mathbb{CP}_1$,

let \tilde{Z} be the hypersurface

$$xy = P_0^\ell P_1 \cdots P_k.$$

Then twistor space Z obtained from \tilde{Z} by

Twistor Spaces for These Metrics:

$$H^0(\mathbb{CP}_1 \times \mathbb{CP}_1, \mathcal{O}(1, 1)) = \mathbb{C}^4 \supset \mathbb{R}^{1,3} \supset \mathcal{H}^3$$

In $\mathcal{O}(k + \ell - 1, 1) \oplus \mathcal{O}(1, k + \ell - 1) \rightarrow \mathbb{CP}_1 \times \mathbb{CP}_1$,

let \tilde{Z} be the hypersurface

$$xy = P_0^\ell P_1 \cdots P_k.$$

Then twistor space Z obtained from \tilde{Z} by

- removing curve in zero section cut out by P_0 ,

Twistor Spaces for These Metrics:

$$H^0(\mathbb{CP}_1 \times \mathbb{CP}_1, \mathcal{O}(1, 1)) = \mathbb{C}^4 \supset \mathbb{R}^{1,3} \supset \mathcal{H}^3$$

In $\mathcal{O}(k + \ell - 1, 1) \oplus \mathcal{O}(1, k + \ell - 1) \rightarrow \mathbb{CP}_1 \times \mathbb{CP}_1$,

let \tilde{Z} be the hypersurface

$$xy = P_0^\ell P_1 \cdots P_k.$$

Then twistor space Z obtained from \tilde{Z} by

- removing curve in zero section cut out by P_0 ,
- adding two rational curves at infinity, and

Twistor Spaces for These Metrics:

$$H^0(\mathbb{CP}_1 \times \mathbb{CP}_1, \mathcal{O}(1, 1)) = \mathbb{C}^4 \supset \mathbb{R}^{1,3} \supset \mathcal{H}^3$$

In $\mathcal{O}(k + \ell - 1, 1) \oplus \mathcal{O}(1, k + \ell - 1) \rightarrow \mathbb{CP}_1 \times \mathbb{CP}_1$,

let \tilde{Z} be the hypersurface

$$xy = P_0^\ell P_1 \cdots P_k.$$

Then twistor space Z obtained from \tilde{Z} by

- removing curve in zero section cut out by P_0 ,
- adding two rational curves at infinity, and
- making small resolutions of isolated singularities.

Any scalar-flat Kähler surface (M^4, g, J) has a

Penrose Twistor Space (Z, J) ,

which is once again a complex 3-manifold.

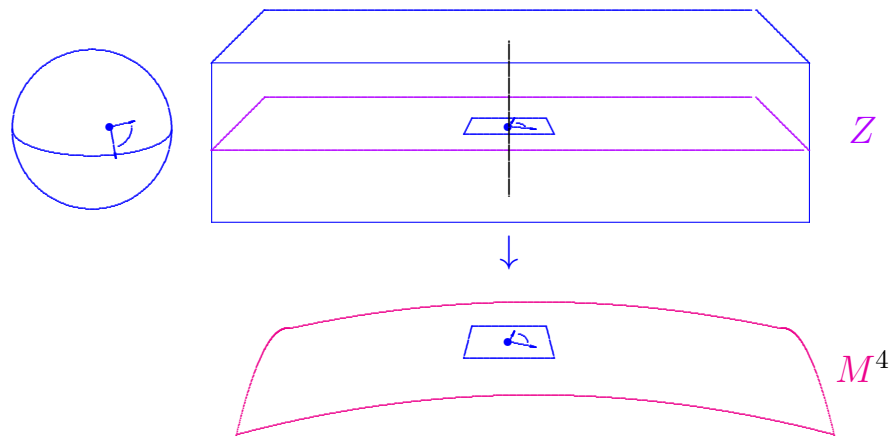

Any scalar-flat Kähler surface (M^4, g, J) has a

Penrose Twistor Space (Z, J) ,

which is once again a complex 3-manifold.

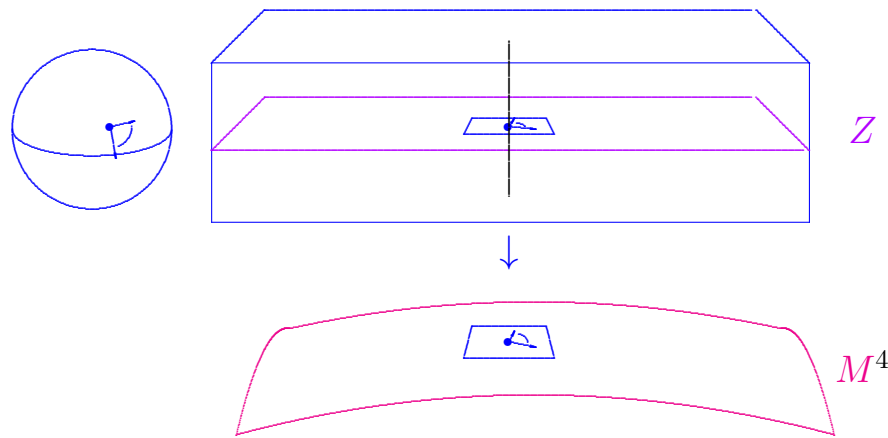

Lots more ALE scalar-flat Kähler surfaces now known:

Any scalar-flat Kähler surface (M^4, g, J) has a

Penrose Twistor Space (Z, J) ,

which is once again a complex 3-manifold.

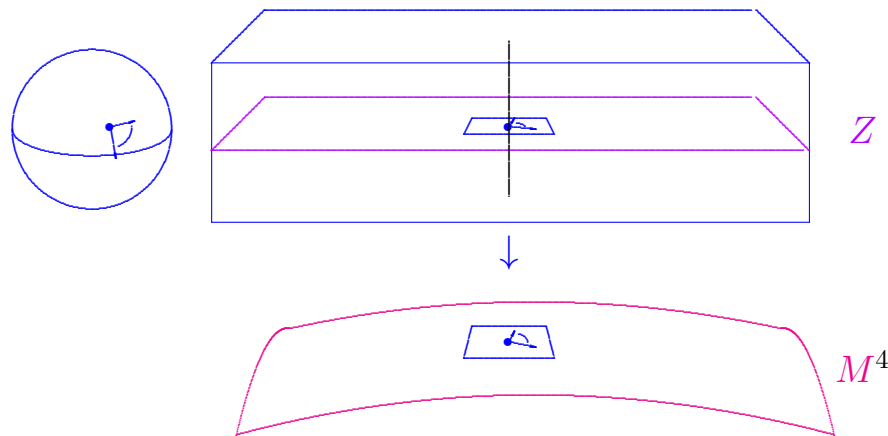

Lots more ALE scalar-flat Kähler surfaces now known:

Joyce, Calderbank-Singer, Lock-Viaclovsky...

Any scalar-flat Kähler surface (M^4, g, J) has a

Penrose Twistor Space (Z, J) ,

which is once again a complex 3-manifold.

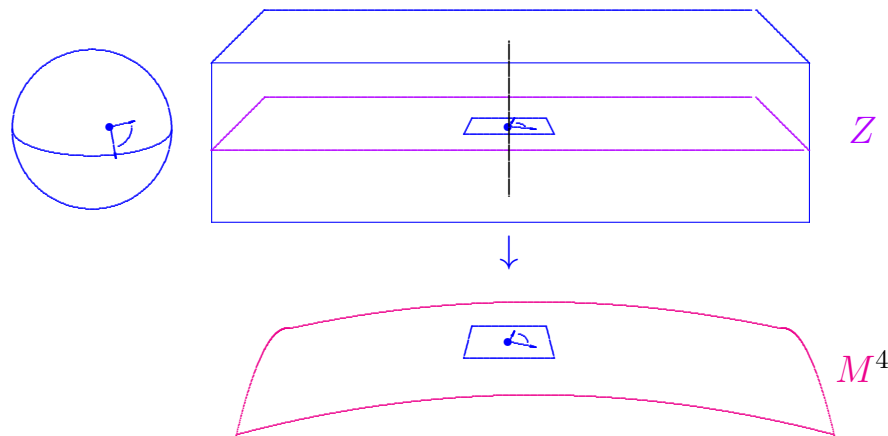

Lots more ALE scalar-flat Kähler surfaces now known:

Joyce, Calderbank-Singer, Lock-Viaclovsky...

But full classification remains an open problem.

Definition. Complete, non-compact n -manifold (M^n, g) is asymptotically locally Euclidean (ALE) if \exists compact set $K \subset M$ such that $M - K \approx \coprod_i (\mathbb{R}^n - D^n) / \Gamma_i$, where $\Gamma_i \subset \mathbf{O}(n)$, such that

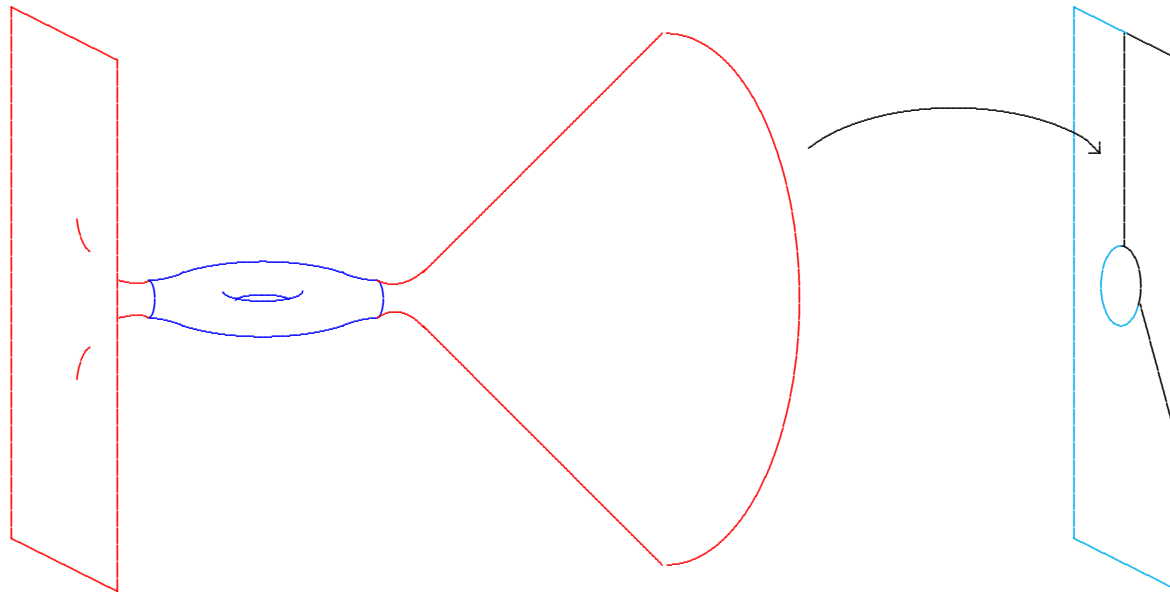

$$g_{jk} = \delta_{jk} + O(|x|^{1-\frac{n}{2}-\varepsilon})$$

$$g_{jk,\ell} = O(|x|^{-\frac{n}{2}-\varepsilon}), \quad s \in L^1$$

Definition. *The mass (at a given end) of an ALE n -manifold is defined to be*

$$m(M, g) := [g_{ij,i} - g_{ii,j}]$$

Definition. *The mass (at a given end) of an ALE n -manifold is defined to be*

$$m(M, g) := \int_{\partial M} [g_{ij,i} - g_{ii,j}] \nu^j$$

Definition. *The mass (at a given end) of an ALE n -manifold is defined to be*

$$m(M, g) := \int_{\Sigma(\varrho)} [g_{ij,i} - g_{ii,j}] \nu^j \alpha_E$$

Definition. *The mass (at a given end) of an ALE n -manifold is defined to be*

$$m(M, g) := \lim_{\varrho \rightarrow \infty} \int_{\Sigma(\varrho)} [g_{ij,i} - g_{ii,j}] \nu^j \alpha_E$$

Definition. *The mass (at a given end) of an ALE n -manifold is defined to be*

$$m(M, g) := \lim_{\varrho \rightarrow \infty} \frac{\Gamma(\frac{n}{2})}{4(n-1)\pi^{n/2}} \int_{\Sigma(\varrho)} [g_{ij,i} - g_{ii,j}] \nu^j \alpha_E$$

Definition. *The mass (at a given end) of an ALE n -manifold is defined to be*

$$m(M, g) := \lim_{\varrho \rightarrow \infty} \frac{\Gamma(\frac{n}{2})}{4(n-1)\pi^{n/2}} \int_{\Sigma(\varrho)} [g_{ij,i} - g_{ii,j}] \nu^j \alpha_E$$

where

Definition. The mass (at a given end) of an *ALE* n -manifold is defined to be

$$m(M, g) := \lim_{\varrho \rightarrow \infty} \frac{\Gamma(\frac{n}{2})}{4(n-1)\pi^{n/2}} \int_{\Sigma(\varrho)} [g_{ij,i} - g_{ii,j}] \nu^j \alpha_E$$

where

- $\Sigma(\varrho) \approx S^{n-1}/\Gamma_i$

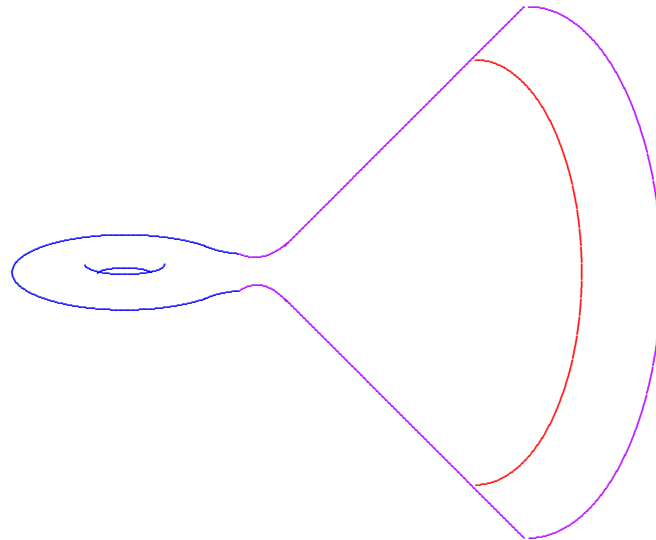

Definition. *The mass (at a given end) of an ALE n -manifold is defined to be*

$$m(M, g) := \lim_{\varrho \rightarrow \infty} \frac{\Gamma(\frac{n}{2})}{4(n-1)\pi^{n/2}} \int_{\Sigma(\varrho)} [g_{ij,i} - g_{ii,j}] \nu^j \alpha_E$$

where

- $\Sigma(\varrho) \approx S^{n-1}/\Gamma_i$ is given by $|\vec{x}| = \varrho$;

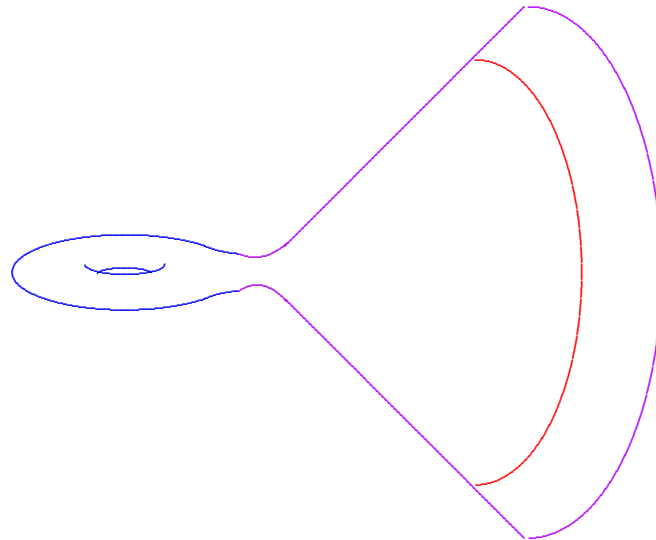

Definition. *The mass (at a given end) of an ALE n -manifold is defined to be*

$$m(M, g) := \lim_{\varrho \rightarrow \infty} \frac{\Gamma(\frac{n}{2})}{4(n-1)\pi^{n/2}} \int_{\Sigma(\varrho)} [g_{ij,i} - g_{ii,j}] \nu^j \alpha_E$$

where

- $\Sigma(\varrho) \approx S^{n-1}/\Gamma_i$ is given by $|\vec{x}| = \varrho$;
- ν is the outpointing Euclidean unit normal;

Definition. *The mass (at a given end) of an ALE n -manifold is defined to be*

$$m(M, g) := \lim_{\varrho \rightarrow \infty} \frac{\Gamma(\frac{n}{2})}{4(n-1)\pi^{n/2}} \int_{\Sigma(\varrho)} [g_{ij,i} - g_{ii,j}] \nu^j \alpha_E$$

where

- $\Sigma(\varrho) \approx S^{n-1}/\Gamma_i$ is given by $|\vec{x}| = \varrho$;
- ν is the outpointing Euclidean unit normal;
and
- α_E is the volume $(n-1)$ -form induced by the Euclidean metric.

Definition. *The mass (at a given end) of an ALE n -manifold is defined to be*

$$m(M, g) := \lim_{\varrho \rightarrow \infty} \frac{\Gamma(\frac{n}{2})}{4(n-1)\pi^{n/2}} \int_{\Sigma(\varrho)} [g_{ij,i} - g_{ii,j}] \nu^j \alpha_E$$

where

- $\Sigma(\varrho) \approx S^{n-1}/\Gamma_i$ is given by $|\vec{x}| = \varrho$;
- ν is the outpointing Euclidean unit normal;
and
- α_E is the volume $(n-1)$ -form induced by the Euclidean metric.

Bartnik/Chruściel (1986):

Definition. *The mass (at a given end) of an ALE n -manifold is defined to be*

$$m(M, g) := \lim_{\varrho \rightarrow \infty} \frac{\Gamma(\frac{n}{2})}{4(n-1)\pi^{n/2}} \int_{\Sigma(\varrho)} [g_{ij,i} - g_{ii,j}] \nu^j \alpha_E$$

where

- $\Sigma(\varrho) \approx S^{n-1}/\Gamma_i$ is given by $|\vec{x}| = \varrho$;
- ν is the outpointing Euclidean unit normal;
and
- α_E is the volume $(n-1)$ -form induced by the Euclidean metric.

Bartnik/Chruściel (1986): With weak fall-off conditions,

Definition. *The mass (at a given end) of an ALE n -manifold is defined to be*

$$m(M, g) := \lim_{\varrho \rightarrow \infty} \frac{\Gamma(\frac{n}{2})}{4(n-1)\pi^{n/2}} \int_{\Sigma(\varrho)} [g_{ij,i} - g_{ii,j}] \nu^j \alpha_E$$

where

- $\Sigma(\varrho) \approx S^{n-1}/\Gamma_i$ is given by $|\vec{x}| = \varrho$;
- ν is the outpointing Euclidean unit normal;
and
- α_E is the volume $(n-1)$ -form induced by the Euclidean metric.

$$g_{jk} = \delta_{jk} + O(|x|^{1-\frac{n}{2}-\varepsilon})$$

$$g_{jk,\ell} = O(|x|^{-\frac{n}{2}-\varepsilon}), \quad s \in L^1$$

Definition. *The mass (at a given end) of an ALE n -manifold is defined to be*

$$m(M, g) := \lim_{\varrho \rightarrow \infty} \frac{\Gamma(\frac{n}{2})}{4(n-1)\pi^{n/2}} \int_{\Sigma(\varrho)} [g_{ij,i} - g_{ii,j}] \nu^j \alpha_E$$

where

- $\Sigma(\varrho) \approx S^{n-1}/\Gamma_i$ is given by $|\vec{x}| = \varrho$;
- ν is the outpointing Euclidean unit normal;
and
- α_E is the volume $(n-1)$ -form induced by the Euclidean metric.

Bartnik/Chruściel (1986): With weak fall-off conditions, the mass is well-defined

Definition. *The mass (at a given end) of an ALE n -manifold is defined to be*

$$m(M, g) := \lim_{\varrho \rightarrow \infty} \frac{\Gamma(\frac{n}{2})}{4(n-1)\pi^{n/2}} \int_{\Sigma(\varrho)} [g_{ij,i} - g_{ii,j}] \nu^j \alpha_E$$

where

- $\Sigma(\varrho) \approx S^{n-1}/\Gamma_i$ is given by $|\vec{x}| = \varrho$;
- ν is the outpointing Euclidean unit normal;
and
- α_E is the volume $(n-1)$ -form induced by the Euclidean metric.

Bartnik/Chruściel (1986): With weak fall-off conditions, the mass is well-defined & coordinate independent.

Definition. *The mass (at a given end) of an ALE n -manifold is defined to be*

$$m(M, g) := \lim_{\varrho \rightarrow \infty} \frac{\Gamma(\frac{n}{2})}{4(n-1)\pi^{n/2}} \int_{\Sigma(\varrho)} [g_{ij,i} - g_{ii,j}] \nu^j \alpha_E$$

where

- $\Sigma(\varrho) \approx S^{n-1}/\Gamma_i$ is given by $|\vec{x}| = \varrho$;
- ν is the outpointing Euclidean unit normal;
and
- α_E is the volume $(n-1)$ -form induced by the Euclidean metric.

Chruściel-type fall-off:

$$g_{jk} - \delta_{jk} \in C_{-\tau}^1, \quad \tau > \frac{n-2}{2}$$

Definition. *The mass (at a given end) of an ALE n -manifold is defined to be*

$$m(M, g) := \lim_{\varrho \rightarrow \infty} \frac{\Gamma(\frac{n}{2})}{4(n-1)\pi^{n/2}} \int_{\Sigma(\varrho)} [g_{ij,i} - g_{ii,j}] \nu^j \alpha_E$$

where

- $\Sigma(\varrho) \approx S^{n-1}/\Gamma_i$ is given by $|\vec{x}| = \varrho$;
- ν is the outpointing Euclidean unit normal;
and
- α_E is the volume $(n-1)$ -form induced by the Euclidean metric.

Bartnik/Chruściel (1986): With weak fall-off conditions, the mass is well-defined & coordinate independent.

Definition. *The mass (at a given end) of an ALE n -manifold is defined to be*

$$m(M, g) := \lim_{\varrho \rightarrow \infty} \frac{\Gamma(\frac{n}{2})}{4(n-1)\pi^{n/2}} \int_{\Sigma(\varrho)} [g_{ij,i} - g_{ii,j}] \nu^j \alpha_E$$

where

- $\Sigma(\varrho) \approx S^{n-1}/\Gamma_i$ is given by $|\vec{x}| = \varrho$;
- ν is the outpointing Euclidean unit normal;
and
- α_E is the volume $(n-1)$ -form induced by the Euclidean metric.

We'll see a new proof of this in the Kähler case.

In fact, we'll eventually prove:

In fact, we'll eventually prove:

Theorem C. Any *ALE Kähler manifold* (M, g, J) of complex dimension m has mass given by

$$m(M, g) = -\frac{\langle \clubsuit(c_1), [\omega]^{m-1} \rangle}{(2m-1)\pi^{m-1}} + \frac{(m-1)!}{4(2m-1)\pi^m} \int_M s_g d\mu_g$$

In fact, we'll eventually prove:

Theorem C. Any ALE Kähler manifold (M, g, J) of complex dimension m has mass given by

$$m(M, g) = -\frac{\langle \clubsuit(c_1), [\omega]^{m-1} \rangle}{(2m-1)\pi^{m-1}} + \frac{(m-1)!}{4(2m-1)\pi^m} \int_M s_g d\mu_g$$

where

- s = scalar curvature;
- $d\mu$ = metric volume form;
- $c_1 = c_1(M, J) \in H^2(M)$ is first Chern class;
- $[\omega] \in H^2(M)$ is Kähler class of (g, J) ; and
- \langle , \rangle is pairing between $H_c^2(M)$ and $H^{2m-2}(M)$.

In fact, we'll eventually prove:

Theorem C. Any *ALE Kähler manifold* (M, g, J) of complex dimension m has mass given by

$$m(M, g) = -\frac{\langle \clubsuit(c_1), [\omega]^{m-1} \rangle}{(2m-1)\pi^{m-1}} + \frac{(m-1)!}{4(2m-1)\pi^m} \int_M s_g d\mu_g$$

where

- s = scalar curvature;
- $d\mu$ = metric volume form;
- $c_1 = c_1(M, J) \in H^2(M)$ is first Chern class;
- $[\omega] \in H^2(M)$ is Kähler class of (g, J) ; and
- \langle , \rangle is pairing between $H_c^2(M)$ and $H^{2m-2}(M)$.
- $\clubsuit : H^2(M) \xrightarrow{\cong} H_c^2(M)$ inverse of natural map.

$$m(M, g) = -\frac{\langle \clubsuit(c_1), [\omega]^{m-1} \rangle}{(2m-1)\pi^{m-1}} + \frac{(m-1)!}{4(2m-1)\pi^m} \int_M s_g d\mu_g$$

Scalar-flat Kähler case:

$$m(M, g) = -\frac{\langle \clubsuit(c_1), [\omega]^{m-1} \rangle}{(2m-1)\pi^{m-1}}$$

Scalar-flat Kähler surface:

$$m(M, g) = -\frac{1}{3\pi} \langle \clubsuit(c_1), [\omega] \rangle$$

Scalar-flat Kähler surface:

$$m(M, g) = -\frac{1}{3\pi} \langle \clubsuit(c_1), [\omega] \rangle$$

Today: What does this mean in practice?

Scalar-flat Kähler surface:

$$m(M, g) = -\frac{1}{3\pi} \langle \clubsuit(c_1), [\omega] \rangle$$

Scalar-flat Kähler surface:

$$m(M, g) = -\frac{1}{3\pi} \langle \clubsuit(c_1), [\omega] \rangle$$

Scalar-flat Kähler surface:

$$m(M, g) = -\frac{1}{3\pi} \langle \clubsuit(c_1), [\omega] \rangle$$

Gravitational instantons?

Scalar-flat Kähler surface:

$$m(M, g) = -\frac{1}{3\pi} \langle \clubsuit(c_1), [\omega] \rangle$$

Gravitational instantons?

Ricci flat!

Scalar-flat Kähler surface:

$$m(M, g) = -\frac{1}{3\pi} \langle \clubsuit(c_1), [\omega] \rangle$$

Gravitational instantons?

Ricci flat! $\implies c_1 = 0$.

Scalar-flat Kähler surface:

$$m(M, g) = -\frac{1}{3\pi} \langle \clubsuit(c_1), [\omega] \rangle$$

Gravitational instantons?

Ricci flat! $\implies c_1 = 0$.

Mass automatically vanishes!

Scalar-flat Kähler surface:

$$m(M, g) = -\frac{1}{3\pi} \langle \clubsuit(c_1), [\omega] \rangle$$

Gravitational instantons?

Ricci flat! $\implies c_1 = 0$.

Mass automatically vanishes!

Bartnik: Ricci-flat \implies faster fall-off of metric!

Scalar-flat Kähler surface:

$$m(M, g) = -\frac{1}{3\pi} \langle \clubsuit(c_1), [\omega] \rangle$$

Gravitational instantons?

Ricci flat! $\implies c_1 = 0$.

Mass automatically vanishes!

Bartnik: Ricci-flat \implies mass vanishes!

Scalar-flat Kähler surface:

$$m(M, g) = -\frac{1}{3\pi} \langle \clubsuit(c_1), [\omega] \rangle$$

What does this mean in practice?

Scalar-flat Kähler surface:

$$m(M, g) = -\frac{1}{3\pi} \langle \clubsuit(c_1), [\omega] \rangle$$

Exploit Poincaré duality...

Proposition. *Let (M, g, J) be an ALE scalar-flat Kähler surface.*

Proposition. *Let (M, g, J) be an ALE scalar-flat Kähler surface. Let E_1, \dots, E_ℓ be a basis for $H_2(M, \mathbb{R})$,*

Proposition. *Let (M, g, J) be an ALE scalar-flat Kähler surface. Let E_1, \dots, E_ℓ be a basis for $H_2(M, \mathbb{R})$, and let $Q = [Q_{jk}] = [E_j \cdot E_k]$ be the corresponding intersection matrix.*

Proposition. *Let (M, g, J) be an ALE scalar-flat Kähler surface. Let E_1, \dots, E_ℓ be a basis for $H_2(M, \mathbb{R})$, and let $Q = [Q_{jk}] = [E_j \cdot E_k]$ be the corresponding intersection matrix. If we define a_1, \dots, a_ℓ by*

Proposition. *Let (M, g, J) be an ALE scalar-flat Kähler surface. Let E_1, \dots, E_ℓ be a basis for $H_2(M, \mathbb{R})$, and let $Q = [Q_{jk}] = [E_j \cdot E_k]$ be the corresponding intersection matrix. If we define a_1, \dots, a_ℓ by*

$$\begin{bmatrix} a_1 \\ \vdots \\ a_\ell \end{bmatrix} = Q^{-1} \begin{bmatrix} \int_{E_1} c_1 \\ \vdots \\ \int_{E_\ell} c_1 \end{bmatrix}$$

Proposition. *Let (M, g, J) be an ALE scalar-flat Kähler surface. Let E_1, \dots, E_ℓ be a basis for $H_2(M, \mathbb{R})$, and let $Q = [Q_{jk}] = [E_j \cdot E_k]$ be the corresponding intersection matrix. If we define a_1, \dots, a_ℓ by*

$$\begin{bmatrix} a_1 \\ \vdots \\ a_\ell \end{bmatrix} = Q^{-1} \begin{bmatrix} \int_{E_1} c_1 \\ \vdots \\ \int_{E_\ell} c_1 \end{bmatrix}$$

then the mass of (M, g) is given by

Proposition. Let (M, g, J) be an ALE scalar-flat Kähler surface. Let E_1, \dots, E_ℓ be a basis for $H_2(M, \mathbb{R})$, and let $Q = [Q_{jk}] = [E_j \cdot E_k]$ be the corresponding intersection matrix. If we define a_1, \dots, a_ℓ by

$$\begin{bmatrix} a_1 \\ \vdots \\ a_\ell \end{bmatrix} = Q^{-1} \begin{bmatrix} \int_{E_1} c_1 \\ \vdots \\ \int_{E_\ell} c_1 \end{bmatrix}$$

then the mass of (M, g) is given by

$$m(M, g) = -\frac{1}{3\pi} \sum_{j=1}^{\ell} a_j \int_{E_j} [\omega]$$

Proposition. Let (M, g, J) be an ALE scalar-flat Kähler surface. Let E_1, \dots, E_ℓ be a basis for $H_2(M, \mathbb{R})$, and let $Q = [Q_{jk}] = [E_j \cdot E_k]$ be the corresponding intersection matrix. If we define a_1, \dots, a_ℓ by

$$\begin{bmatrix} a_1 \\ \vdots \\ a_\ell \end{bmatrix} = Q^{-1} \begin{bmatrix} \int_{E_1} c_1 \\ \vdots \\ \int_{E_\ell} c_1 \end{bmatrix}$$

then the mass of (M, g) is given by

$$m(M, g) = -\frac{1}{3\pi} \sum_{j=1}^{\ell} a_j \int_{E_j} [\omega]$$

where $[\omega]$ denotes the Kähler class of (M, g, J) .

Scalar-flat Kähler surface:

$$m(M, g) = -\frac{1}{3\pi} \langle \clubsuit(c_1), [\omega] \rangle$$

Scalar-flat Kähler surface:

$$m(M, g) = -\frac{1}{3\pi} \langle \clubsuit(c_1), [\omega] \rangle$$

Example. Blow up \mathbb{C}^2 at k points.

Scalar-flat Kähler surface:

$$m(M, g) = -\frac{1}{3\pi} \langle \clubsuit(c_1), [\omega] \rangle$$

Example. Blow up \mathbb{C}^2 at k points.

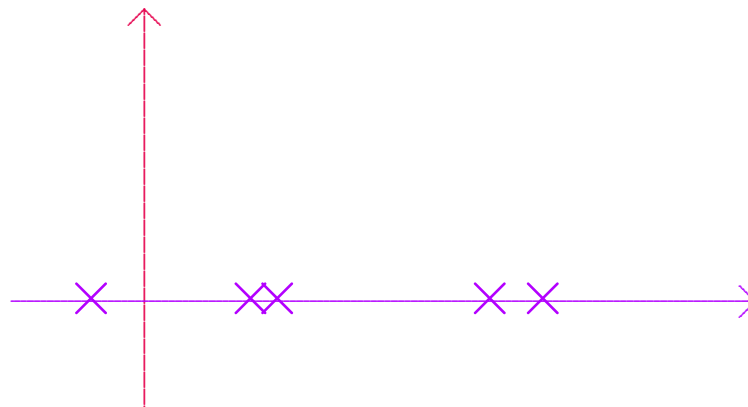

Scalar-flat Kähler surface:

$$m(M, g) = -\frac{1}{3\pi} \langle \clubsuit(c_1), [\omega] \rangle$$

Example. Blow up \mathbb{C}^2 at k points.

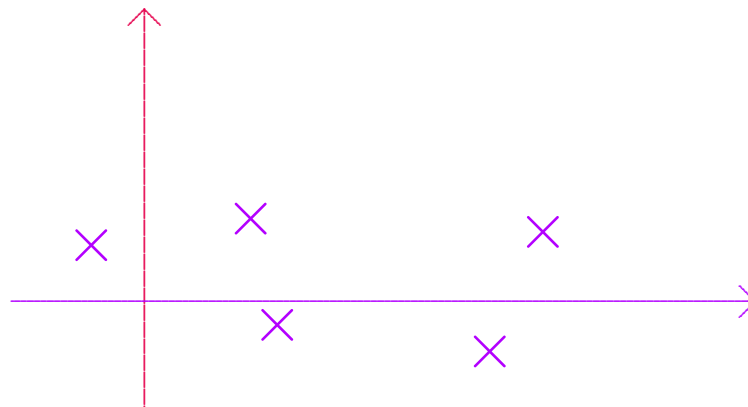

Scalar-flat Kähler surface:

$$m(M, g) = -\frac{1}{3\pi} \langle \clubsuit(c_1), [\omega] \rangle$$

Example. Blow up \mathbb{C}^2 at k points.

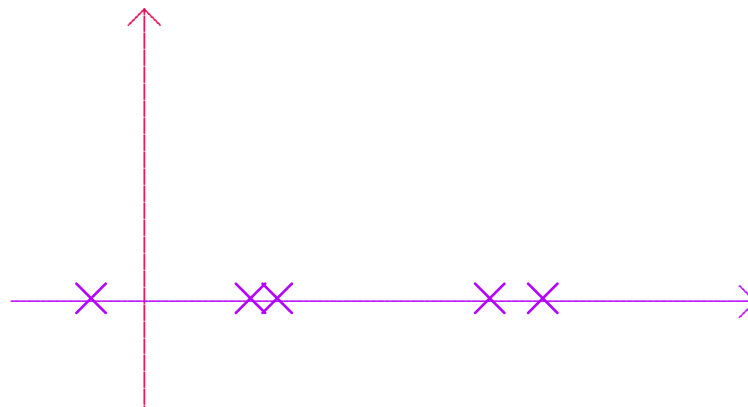

Scalar-flat Kähler surface:

$$m(M, g) = -\frac{1}{3\pi} \langle \clubsuit(c_1), [\omega] \rangle$$

Example. Blow up \mathbb{C}^2 at k points.

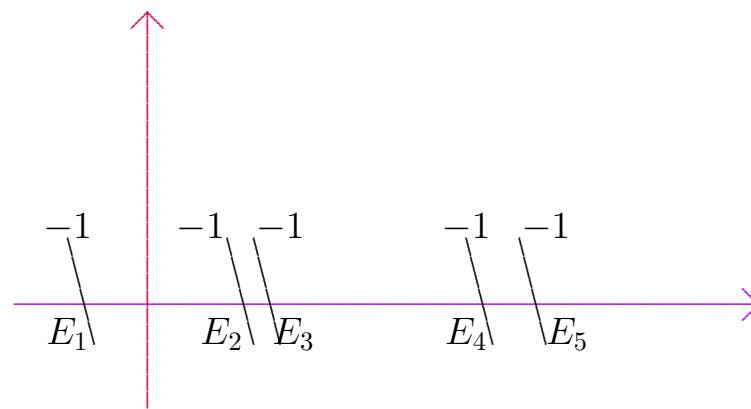

Proposition. Let (M, g, J) be an ALE scalar-flat Kähler surface. Let E_1, \dots, E_ℓ be a basis for $H_2(M, \mathbb{R})$, and let $Q = [Q_{jk}] = [E_j \cdot E_k]$ be the corresponding intersection matrix. If we define a_1, \dots, a_ℓ by

$$\begin{bmatrix} a_1 \\ \vdots \\ a_\ell \end{bmatrix} = Q^{-1} \begin{bmatrix} \int_{E_1} c_1 \\ \vdots \\ \int_{E_\ell} c_1 \end{bmatrix}$$

then the mass of (M, g) is given by

$$m(M, g) = -\frac{1}{3\pi} \sum_{j=1}^{\ell} a_j \int_{E_j} [\omega]$$

where $[\omega]$ denotes the Kähler class of (M, g, J) .

Scalar-flat Kähler surface:

$$m(M, g) = -\frac{1}{3\pi} \langle \clubsuit(c_1), [\omega] \rangle$$

Example. Blow up \mathbb{C}^2 at k points.

$$m(M, g) = \frac{1}{3\pi} \sum_{j=1}^{\ell} \int_{E_j} [\omega]$$

Scalar-flat Kähler surface:

$$m(M, g) = -\frac{1}{3\pi} \langle \clubsuit(c_1), [\omega] \rangle$$

Example. Blow up \mathbb{C}^2 at k points.

$$m(M, g) = \frac{1}{3\pi} \sum_{j=1}^{\ell} \int_{E_j} [\omega]$$

Always positive!

Scalar-flat Kähler surface:

$$m(M, g) = -\frac{1}{3\pi} \langle \clubsuit(c_1), [\omega] \rangle$$

Example. Blow up \mathbb{C}^2 at k points.

$$m(M, g) = \frac{1}{3\pi} \sum_{j=1}^{\ell} \int_{E_j} [\omega]$$

Always positive! (AE): Positive mass theorem.

Scalar-flat Kähler surface:

$$m(M, g) = -\frac{1}{3\pi} \langle \clubsuit(c_1), [\omega] \rangle$$

Scalar-flat Kähler surface:

$$m(M, g) = -\frac{1}{3\pi} \langle \clubsuit(c_1), [\omega] \rangle$$

Example. Blow up Chern-class $-\ell$ line bundle over $\mathbb{C}P_1$ at k points on zero section Σ .

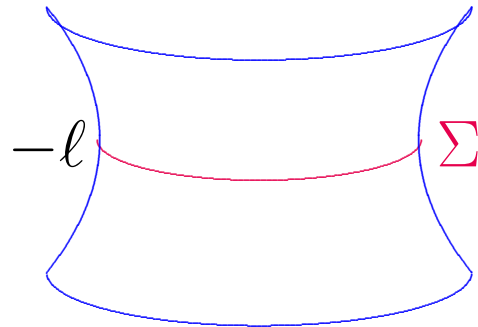

Scalar-flat Kähler surface:

$$m(M, g) = -\frac{1}{3\pi} \langle \clubsuit(c_1), [\omega] \rangle$$

Example. Blow up Chern-class $-\ell$ line bundle over $\mathbb{C}P_1$ at k points on zero section Σ .

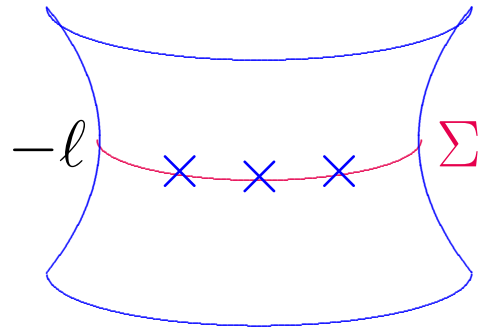

Scalar-flat Kähler surface:

$$m(M, g) = -\frac{1}{3\pi} \langle \clubsuit(c_1), [\omega] \rangle$$

Example. Blow up Chern-class $-\ell$ line bundle over $\mathbb{C}P_1$ at k points on zero section Σ .

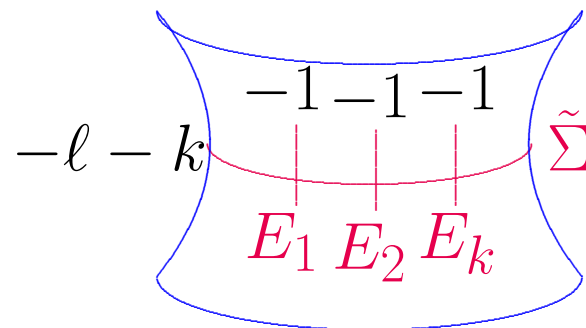

Proposition. Let (M, g, J) be an ALE scalar-flat Kähler surface. Let E_1, \dots, E_ℓ be a basis for $H_2(M, \mathbb{R})$, and let $Q = [Q_{jk}] = [E_j \cdot E_k]$ be the corresponding intersection matrix. If we define a_1, \dots, a_ℓ by

$$\begin{bmatrix} a_1 \\ \vdots \\ a_\ell \end{bmatrix} = Q^{-1} \begin{bmatrix} \int_{E_1} c_1 \\ \vdots \\ \int_{E_\ell} c_1 \end{bmatrix}$$

then the mass of (M, g) is given by

$$m(M, g) = -\frac{1}{3\pi} \sum_{j=1}^{\ell} a_j \int_{E_j} [\omega]$$

where $[\omega]$ denotes the Kähler class of (M, g, J) .

Scalar-flat Kähler surface:

$$m(M, g) = -\frac{1}{3\pi} \langle \clubsuit(c_1), [\omega] \rangle$$

Example. Blow up Chern-class $-\ell$ line bundle over $\mathbb{C}P_1$ at k points on zero section Σ .

$$m(M, g) =$$

Scalar-flat Kähler surface:

$$m(M, g) = -\frac{1}{3\pi} \langle \clubsuit(c_1), [\omega] \rangle$$

Example. Blow up Chern-class $-\ell$ line bundle over $\mathbb{C}\mathbb{P}_1$ at k points on zero section Σ .

$$m(M, g) = \frac{1}{3\pi\ell} \left[(2 - \ell) \int_{\tilde{\Sigma}} \omega \right].$$

Scalar-flat Kähler surface:

$$m(M, g) = -\frac{1}{3\pi} \langle \clubsuit(c_1), [\omega] \rangle$$

Example. Blow up Chern-class $-\ell$ line bundle over $\mathbb{C}P_1$ at k points on zero section Σ .

$$m(M, g) = \frac{1}{3\pi\ell} \left[(2 - \ell) \int_{\tilde{\Sigma}} \omega + 2 \sum_{j=1}^k \int_{E_j} \omega \right] .$$

Proposition. Let (M, g, J) be an ALE scalar-flat Kähler surface. Let E_1, \dots, E_ℓ be a basis for $H_2(M, \mathbb{R})$, and let $Q = [Q_{jk}] = [E_j \cdot E_k]$ be the corresponding intersection matrix. If we define a_1, \dots, a_ℓ by

$$\begin{bmatrix} a_1 \\ \vdots \\ a_\ell \end{bmatrix} = Q^{-1} \begin{bmatrix} \int_{E_1} c_1 \\ \vdots \\ \int_{E_\ell} c_1 \end{bmatrix}$$

then the mass of (M, g) is given by

$$m(M, g) = -\frac{1}{3\pi} \sum_{j=1}^{\ell} a_j \int_{E_j} [\omega]$$

where $[\omega]$ denotes the Kähler class of (M, g, J) .

Theorem B. *Let (M^4, g, J) be an ALE scalar-flat Kähler surface,*

Theorem B. *Let (M^4, g, J) be an ALE scalar-flat Kähler surface, and suppose that (M, J) is the minimal resolution of a surface singularity.*

Theorem B. *Let (M^4, g, J) be an ALE scalar-flat Kähler surface, and suppose that (M, J) is the minimal resolution of a surface singularity.*

Examples: Hirzebruch-Jung resolution of $\mathbb{C}^2/\mathbb{Z}_\ell$.

Theorem B. *Let (M^4, g, J) be an ALE scalar-flat Kähler surface, and suppose that (M, J) is the minimal resolution of a surface singularity.*

Examples: Hirzebruch-Jung resolution of $\mathbb{C}^2/\mathbb{Z}_\ell$.

$$(z_1, z_2) \mapsto (e^{2\pi i/\ell} z_1, e^{2\pi i k/\ell} z_2)$$

Theorem B. *Let (M^4, g, J) be an ALE scalar-flat Kähler surface, and suppose that (M, J) is the minimal resolution of a surface singularity.*

Examples: Hirzebruch-Jung resolution of $\mathbb{C}^2/\mathbb{Z}_\ell$.

Calderbank-Singer metrics generalize for $k \neq \pm 1$.

Theorem B. *Let (M^4, g, J) be an ALE scalar-flat Kähler surface, and suppose that (M, J) is the minimal resolution of a surface singularity.*

Theorem B. *Let (M^4, g, J) be an ALE scalar-flat Kähler surface, and suppose that (M, J) is the minimal resolution of a surface singularity. Then $m(M, g) \leq 0$,*

Theorem B. *Let (M^4, g, J) be an ALE scalar-flat Kähler surface, and suppose that (M, J) is the minimal resolution of a surface singularity. Then $m(M, g) \leq 0$, with $=$ iff g is Ricci-flat.*

Proposition. Let (M, g, J) be an ALE scalar-flat Kähler surface. Let E_1, \dots, E_ℓ be a basis for $H_2(M, \mathbb{R})$, and let $Q = [Q_{jk}] = [E_j \cdot E_k]$ be the corresponding intersection matrix. If we define a_1, \dots, a_ℓ by

$$\begin{bmatrix} a_1 \\ \vdots \\ a_\ell \end{bmatrix} = Q^{-1} \begin{bmatrix} \int_{E_1} c_1 \\ \vdots \\ \int_{E_\ell} c_1 \end{bmatrix}$$

then the mass of (M, g) is given by

$$m(M, g) = -\frac{1}{3\pi} \sum_{j=1}^{\ell} a_j \int_{E_j} [\omega]$$

where $[\omega]$ denotes the Kähler class of (M, g, J) .

Theorem B. *Let (M^4, g, J) be an ALE scalar-flat Kähler surface, and suppose that (M, J) is the minimal resolution of a surface singularity. Then $m(M, g) \leq 0$, with $=$ iff g is Ricci-flat.*

V. Alexeev: Q^{-1} term-by-term ≤ 0 for these.

Theorem B. *Let (M^4, g, J) be an ALE scalar-flat Kähler surface, and suppose that (M, J) is the minimal resolution of a surface singularity. Then $m(M, g) \leq 0$, with $=$ iff g is Ricci-flat.*

V. Alexeev: Q^{-1} term-by-term ≤ 0 for these.

Brought to our attention by C. Spotti.

Scalar-flat Kähler surface:

$$m(M, g) = -\frac{1}{3\pi} \langle \clubsuit(c_1), [\omega] \rangle$$

$$m(M, g) = -\frac{\langle \clubsuit(c_1), [\omega]^{m-1} \rangle}{(2m-1)\pi^{m-1}} + \frac{(m-1)!}{4(2m-1)\pi^m} \int_M s_g d\mu_g$$

$$m(M, g) = -\frac{\langle \clubsuit(c_1), [\omega]^{m-1} \rangle}{(2m-1)\pi^{m-1}} + \frac{(m-1)!}{4(2m-1)\pi^m} \int_M s_g d\mu_g$$

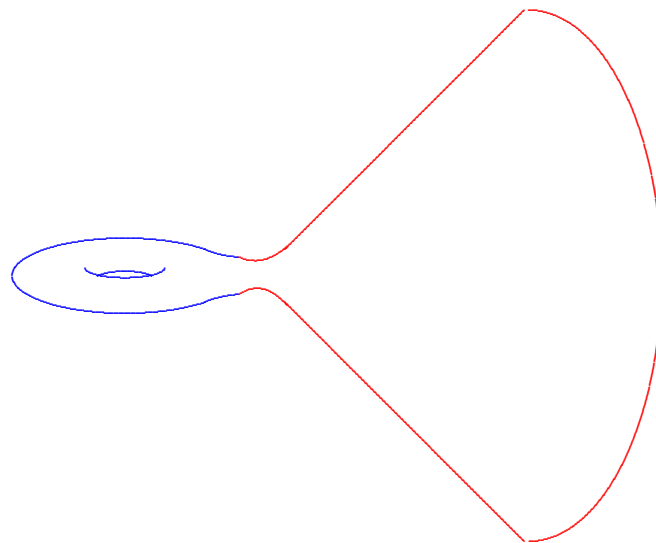

$$m(M, g) = -\frac{\langle \clubsuit(c_1), [\omega]^{m-1} \rangle}{(2m-1)\pi^{m-1}} + \frac{(m-1)!}{4(2m-1)\pi^m} \int_M s_g d\mu_g$$

$$m(M, g) = -\frac{\langle \clubsuit(c_1), [\omega]^{m-1} \rangle}{(2m-1)\pi^{m-1}} + \frac{(m-1)!}{4(2m-1)\pi^m} \int_M s_g d\mu_g$$

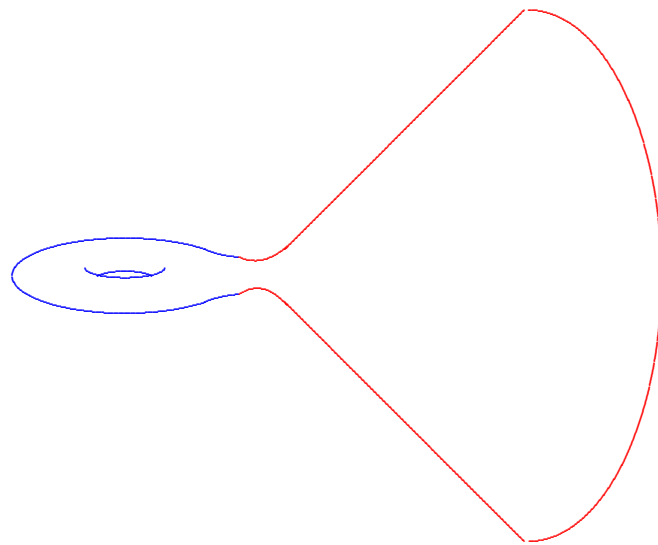

End, Part II