

*Mass, Kähler Manifolds, &*

*Symplectic Geometry*

Claude LeBrun

Stony Brook University

Incontro INdAM:

“Current Developments in Complex Geometry,”  
al Palazzone di Cortona, il 5 giugno, 2019

Mass, Kähler Manifolds,  
and Symplectic Geometry

arXiv: 1810.11417 [math.DG]

Mass, Kähler Manifolds,  
and Symplectic Geometry

arXiv: 1810.11417 [math.DG]

Builds on previous paper

Mass in Kähler Geometry

Comm. Math. Phys. 347 (2016) 621–653.

(Joint with Hans-Joachim Hein)

**Definition.** A complete, non-compact Riemannian  $n$ -manifold  $(M^n, g)$

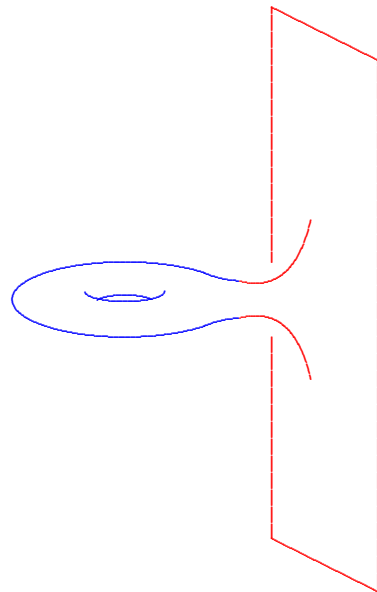

**Definition.** A complete, non-compact Riemannian  $n$ -manifold  $(M^n, g)$

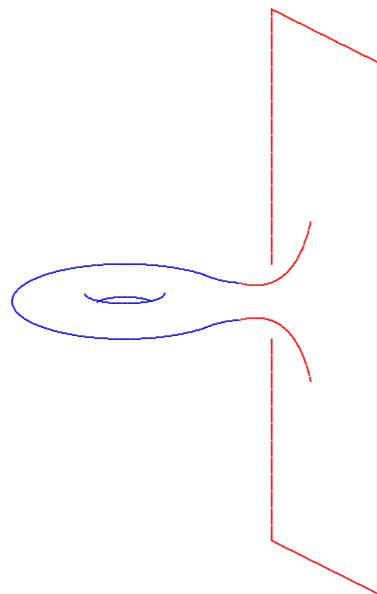

$$n \geq 3$$

**Definition.** A complete, non-compact Riemannian  $n$ -manifold  $(M^n, g)$  is called asymptotically Euclidean

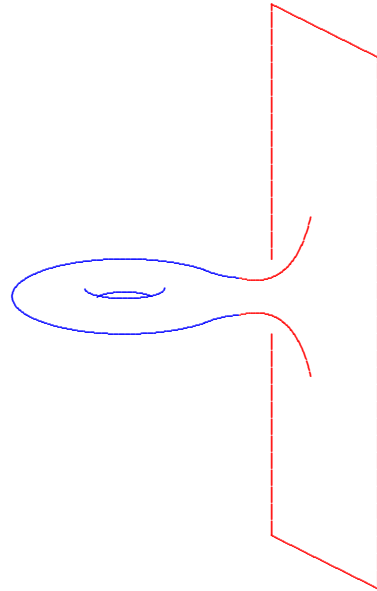

$$n \geq 3$$

**Definition.** A complete, non-compact Riemannian  $n$ -manifold  $(M^n, g)$  is called asymptotically Euclidean (AE)

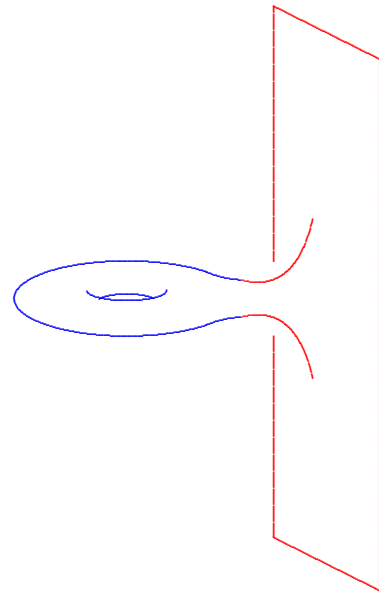

$$n \geq 3$$

**Definition.** A complete, non-compact Riemannian  $n$ -manifold  $(M^n, g)$  is called **asymptotically Euclidean (AE)** if there is a compact set  $K \subset M$

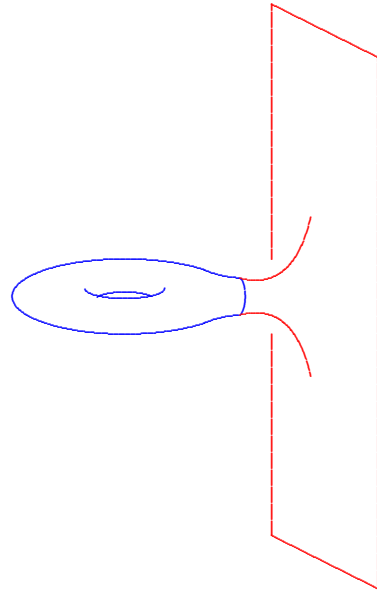



**Definition.** A complete, non-compact Riemannian  $n$ -manifold  $(M^n, g)$  is called **asymptotically Euclidean (AE)** if there is a compact set  $K \subset M$  such that  $M - K$  is diffeomorphic to  $\mathbb{R}^n - D^n$

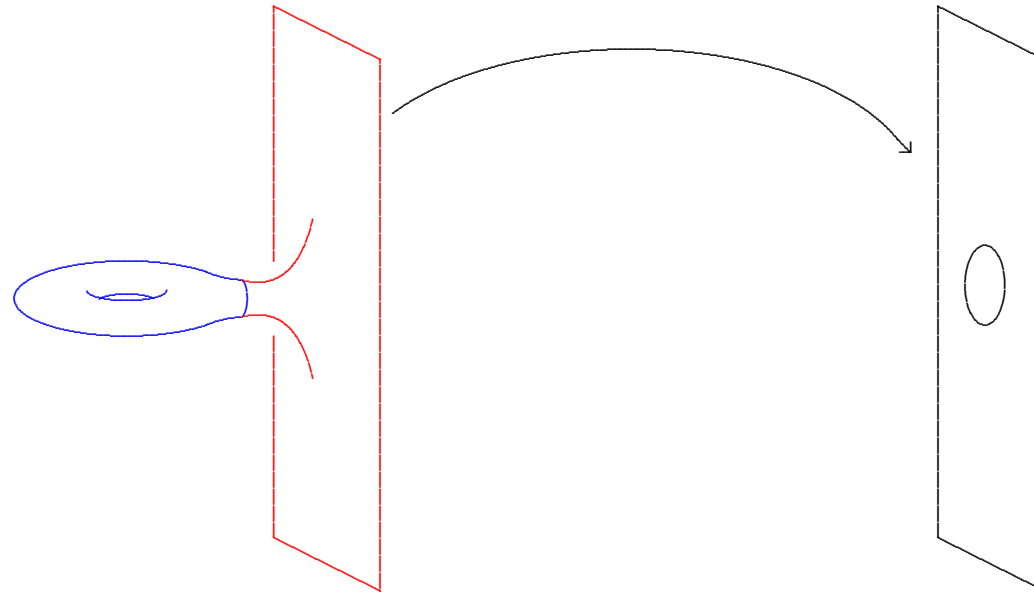

**Definition.** A complete, non-compact Riemannian  $n$ -manifold  $(M^n, g)$  is called **asymptotically Euclidean (AE)** if there is a compact set  $K \subset M$  such that  $M - K$  is diffeomorphic to  $\mathbb{R}^n - D^n$  in such a manner that

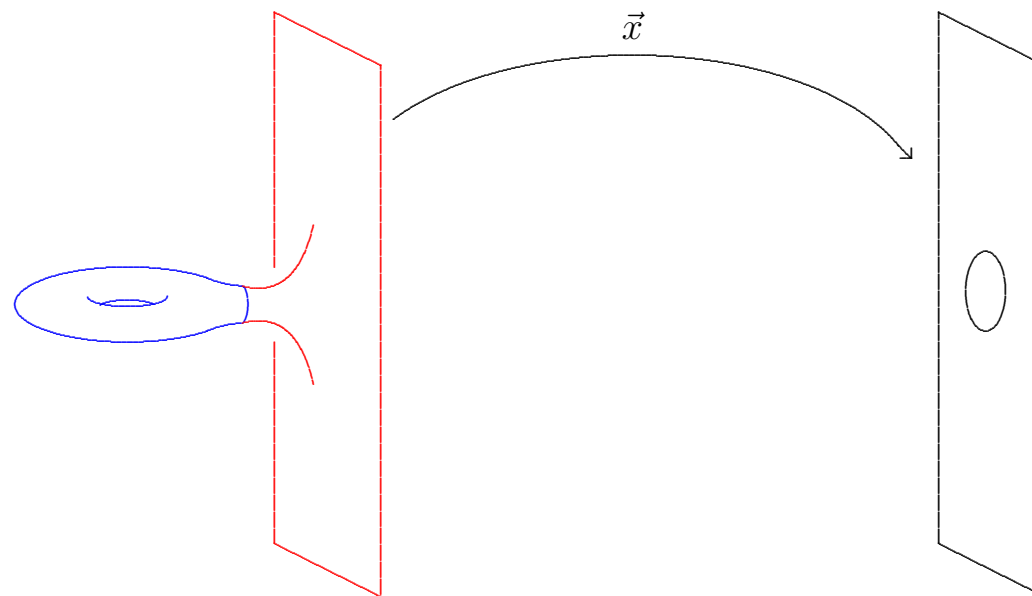

$$g_{jk} = \delta_{jk} + \text{terms that fall-off at infinity}$$

**Definition.** A complete, non-compact Riemannian  $n$ -manifold  $(M^n, g)$  is called **asymptotically Euclidean (AE)** if there is a compact set  $K \subset M$  such that  $M - K$  is diffeomorphic to  $\mathbb{R}^n - D^n$  in such a manner that

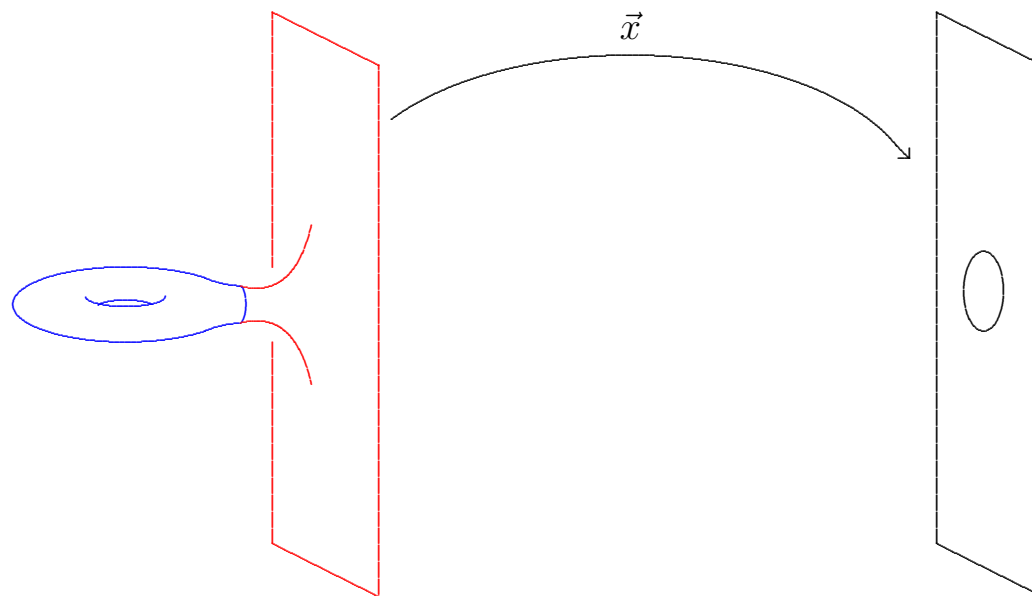

Weakest reasonable assumption:

**Definition.** A complete, non-compact Riemannian  $n$ -manifold  $(M^n, g)$  is called **asymptotically Euclidean (AE)** if there is a compact set  $K \subset M$  such that  $M - K$  is diffeomorphic to  $\mathbb{R}^n - D^n$  in such a manner that

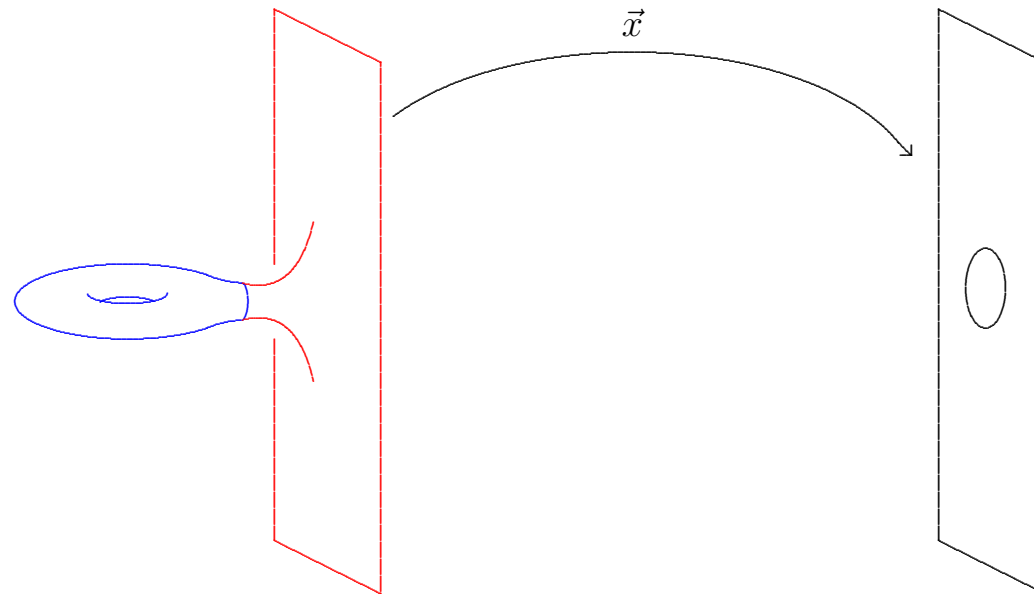

Weakest reasonable assumption:

**Chruściel-type fall-off:**

**Definition.** A complete, non-compact Riemannian  $n$ -manifold  $(M^n, g)$  is called **asymptotically Euclidean (AE)** if there is a compact set  $K \subset M$  such that  $M - K$  is diffeomorphic to  $\mathbb{R}^n - D^n$  in such a manner that

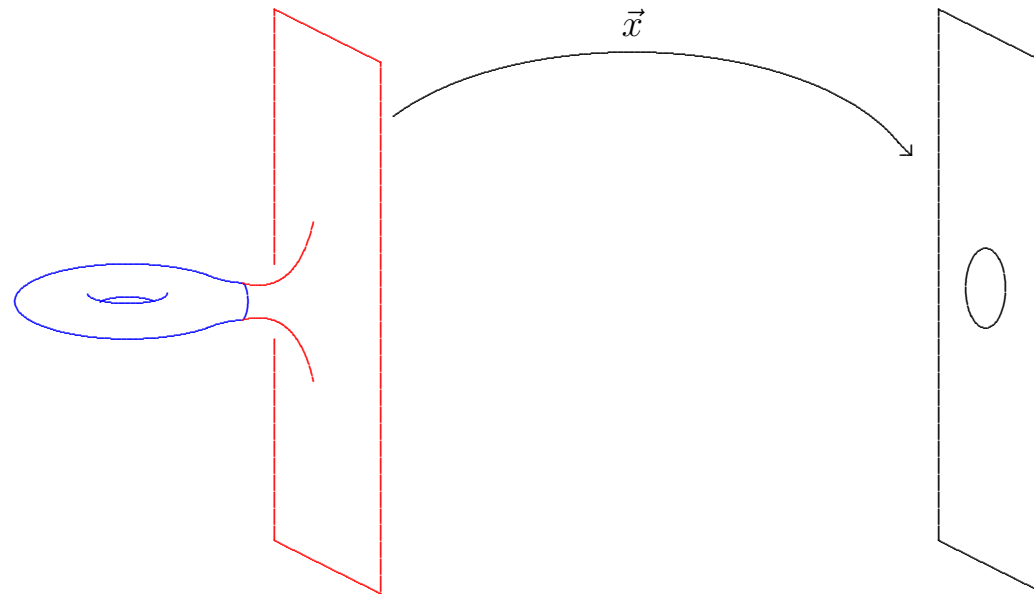

$$g_{jk} = \delta_{jk} + O(|x|^{1-\frac{n}{2}-\varepsilon})$$

**Definition.** A complete, non-compact Riemannian  $n$ -manifold  $(M^n, g)$  is called **asymptotically Euclidean (AE)** if there is a compact set  $K \subset M$  such that  $M - K$  is diffeomorphic to  $\mathbb{R}^n - D^n$  in such a manner that

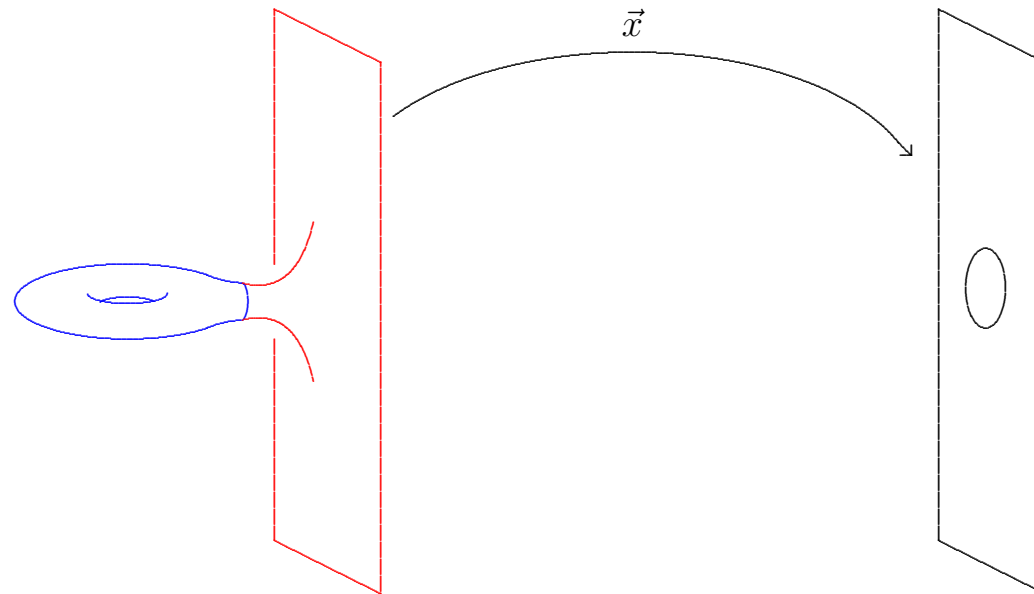

$$g_{jk} = \delta_{jk} + O(|x|^{1-\frac{n}{2}-\varepsilon})$$

$$g_{jk,\ell} = O(|x|^{-\frac{n}{2}-\varepsilon})$$

**Definition.** A complete, non-compact Riemannian  $n$ -manifold  $(M^n, g)$  is called **asymptotically Euclidean (AE)** if there is a compact set  $K \subset M$  such that  $M - K$  is diffeomorphic to  $\mathbb{R}^n - D^n$  in such a manner that

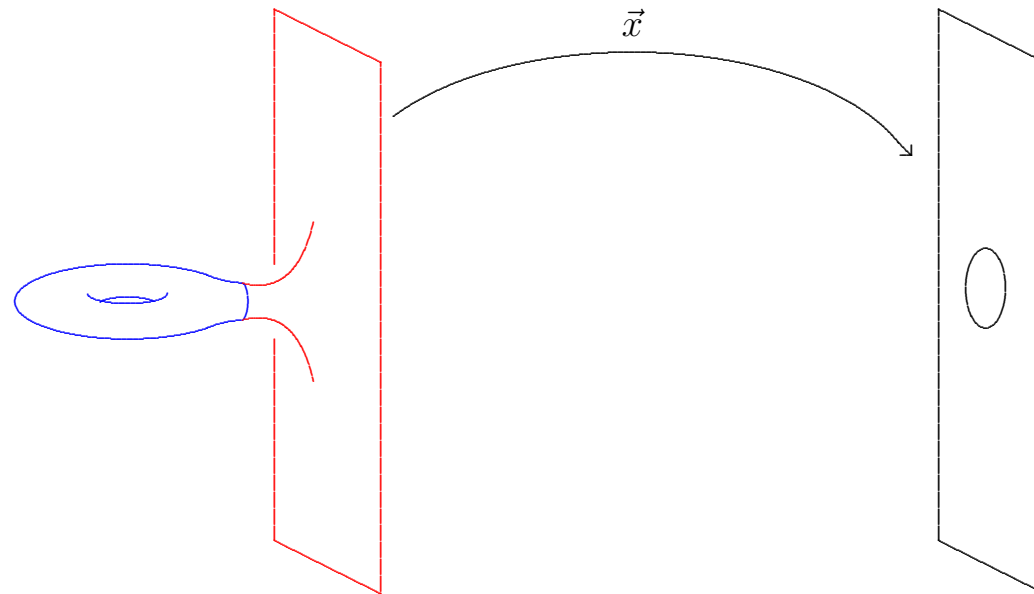

$$g_{jk} = \delta_{jk} + O(|x|^{1-\frac{n}{2}-\varepsilon})$$

$$g_{jk,\ell} = O(|x|^{-\frac{n}{2}-\varepsilon}), \quad s \in L^1$$

**Definition.** A complete, non-compact Riemannian  $n$ -manifold  $(M^n, g)$  is called **asymptotically Euclidean (AE)** if there is a compact set  $K \subset M$  such that  $M - K$  is diffeomorphic to  $\mathbb{R}^n - D^n$  in such a manner that

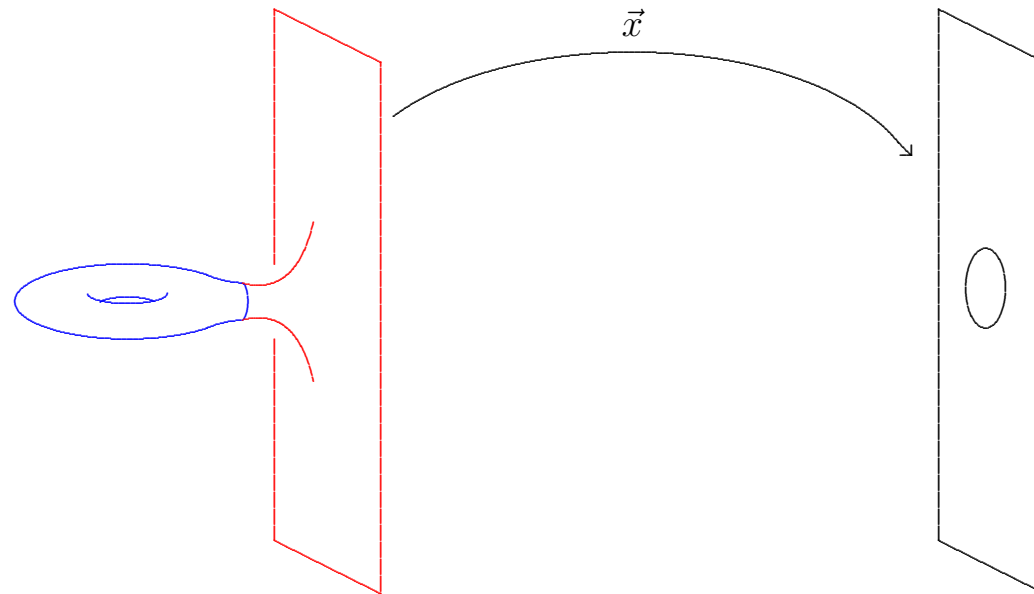

$$g_{jk} = \delta_{jk} + O(|x|^{1-\frac{n}{2}-\varepsilon})$$

$$g_{jk,\ell} = O(|x|^{-\frac{n}{2}-\varepsilon}), \quad \text{scalar curvature} \in L^1$$



**Definition.** A complete, non-compact Riemannian  $n$ -manifold  $(M^n, g)$  is called **asymptotically Euclidean (AE)** if there is a compact set  $K \subset M$  such that  $M - K$  is diffeomorphic to  $\mathbb{R}^n - D^n$  in such a manner that

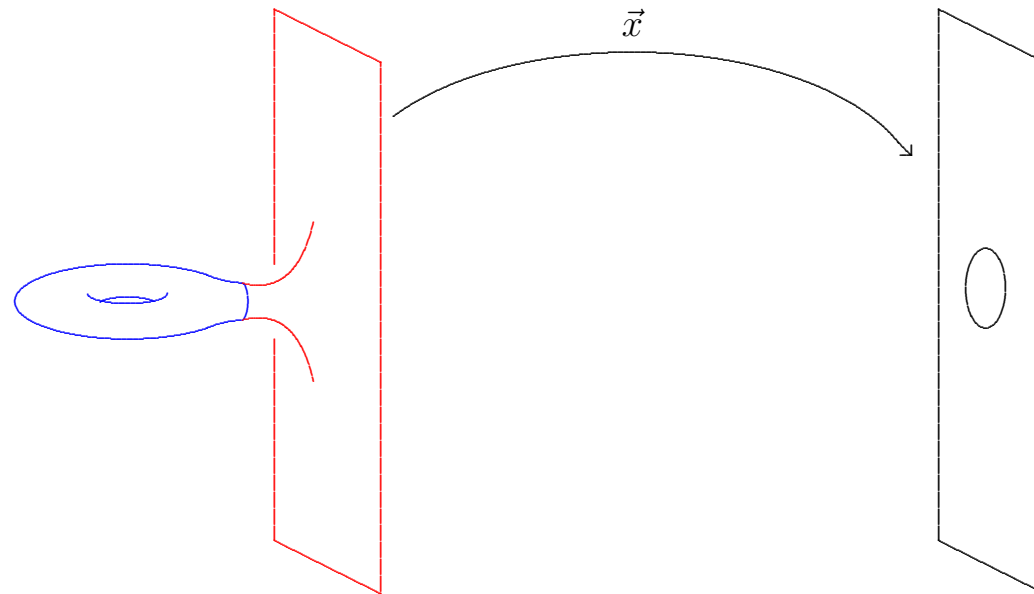

$$g_{jk} = \delta_{jk} + O(|x|^{1-\frac{n}{2}-\varepsilon})$$

$$g_{jk,\ell} = O(|x|^{-\frac{n}{2}-\varepsilon}), \quad s \in L^1$$

**Definition.** A complete, non-compact Riemannian  $n$ -manifold  $(M^n, g)$  is called **asymptotically Euclidean (AE)** if there is a compact set  $K \subset M$  such that each component of  $M - K$  is diffeomorphic to  $\mathbb{R}^n - D^n$  in such a manner that

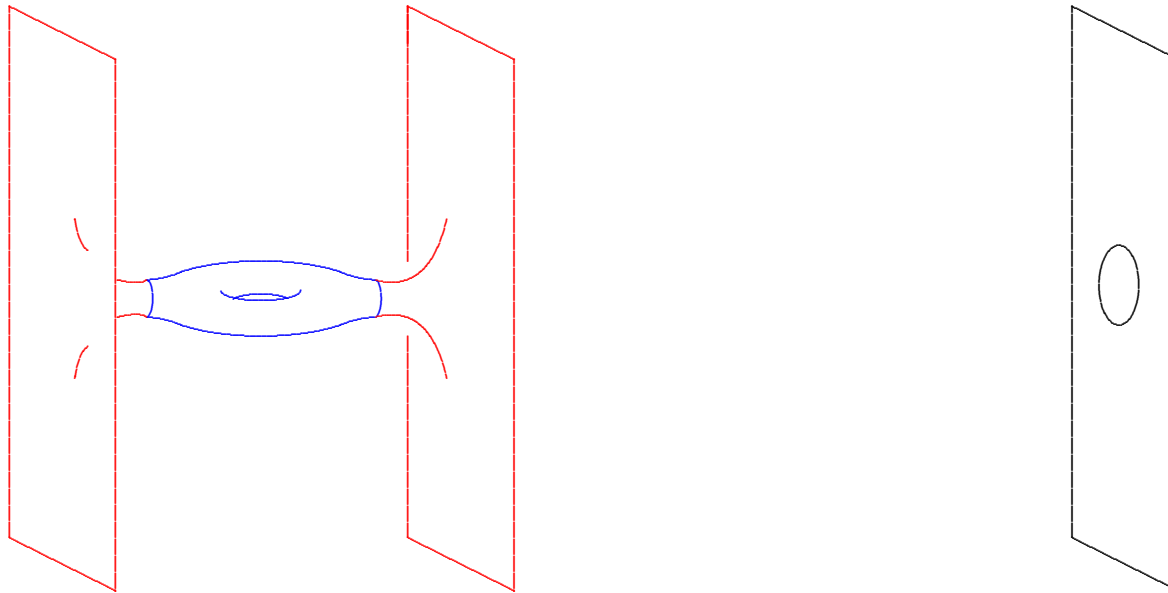

$$g_{jk} = \delta_{jk} + O(|x|^{1-\frac{n}{2}-\varepsilon})$$

$$g_{jk,\ell} = O(|x|^{-\frac{n}{2}-\varepsilon}), \quad s \in L^1$$

**Definition.** A complete, non-compact Riemannian  $n$ -manifold  $(M^n, g)$  is called **asymptotically Euclidean (AE)** if there is a compact set  $K \subset M$  such that each component of  $M - K$  is diffeomorphic to  $\mathbb{R}^n - D^n$  in such a manner that

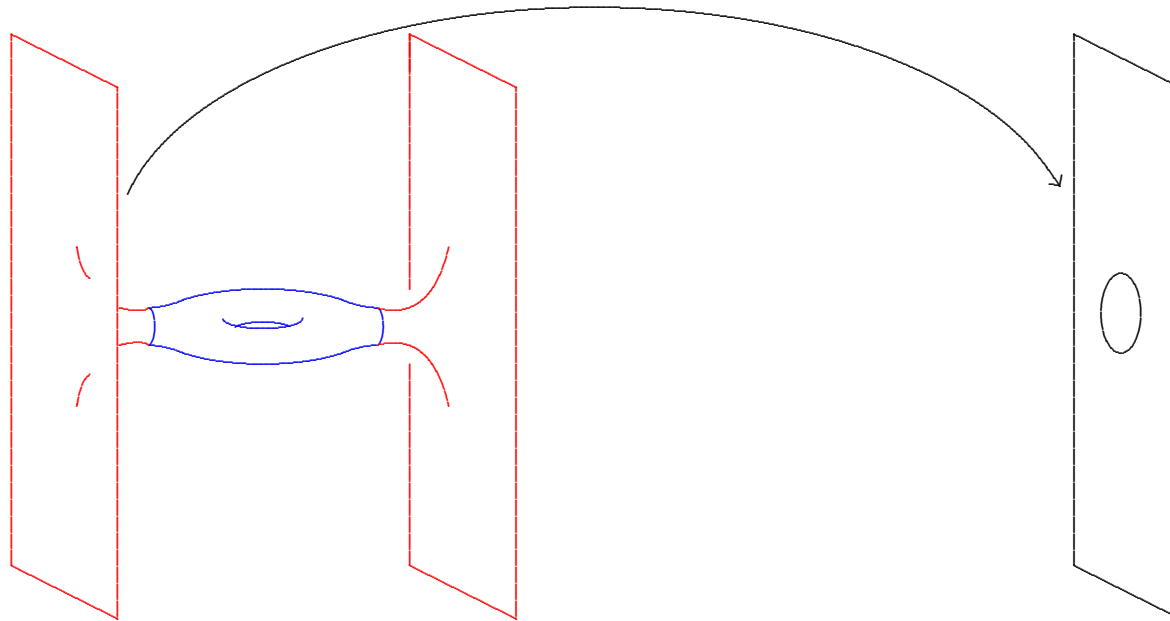

$$g_{jk} = \delta_{jk} + O(|x|^{1-\frac{n}{2}-\varepsilon})$$

$$g_{jk,\ell} = O(|x|^{-\frac{n}{2}-\varepsilon}), \quad s \in L^1$$

**Definition.** A complete, non-compact Riemannian  $n$ -manifold  $(M^n, g)$  is called **asymptotically Euclidean (AE)** if there is a compact set  $K \subset M$  such that each component of  $M - K$  is diffeomorphic to  $\mathbb{R}^n - D^n$  in such a manner that

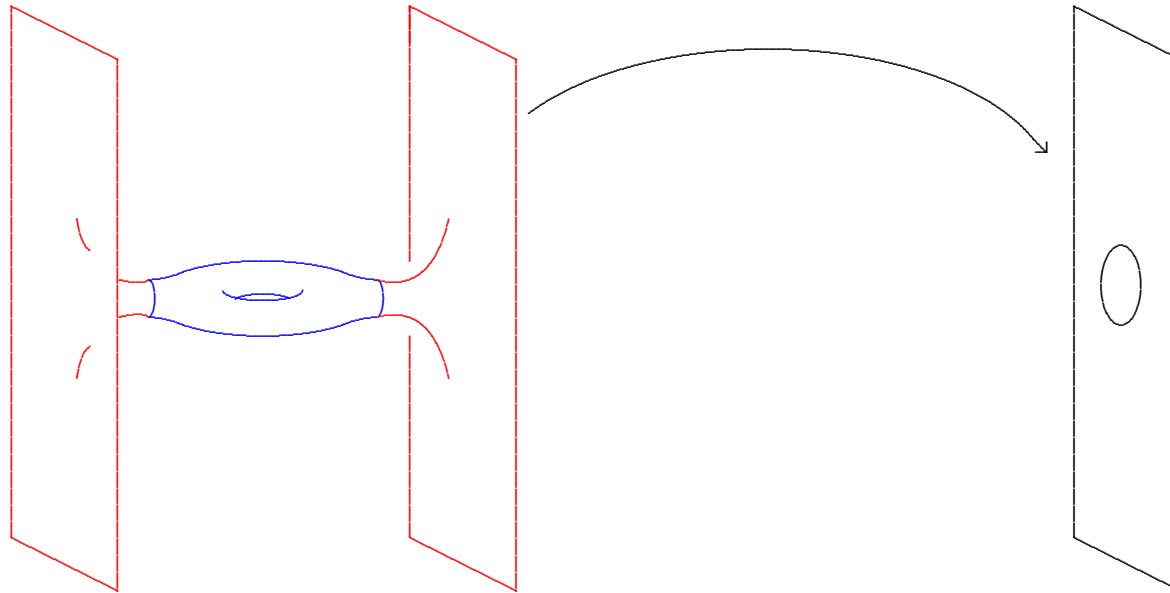

$$g_{jk} = \delta_{jk} + O(|x|^{1-\frac{n}{2}-\varepsilon})$$

$$g_{jk,\ell} = O(|x|^{-\frac{n}{2}-\varepsilon}), \quad s \in L^1$$

**Definition.** A complete, non-compact Riemannian  $n$ -manifold  $(M^n, g)$  is called **asymptotically Euclidean (AE)** if there is a compact set  $K \subset M$  such that each component of  $M - K$  is diffeomorphic to  $\mathbb{R}^n - D^n$  in such a manner that

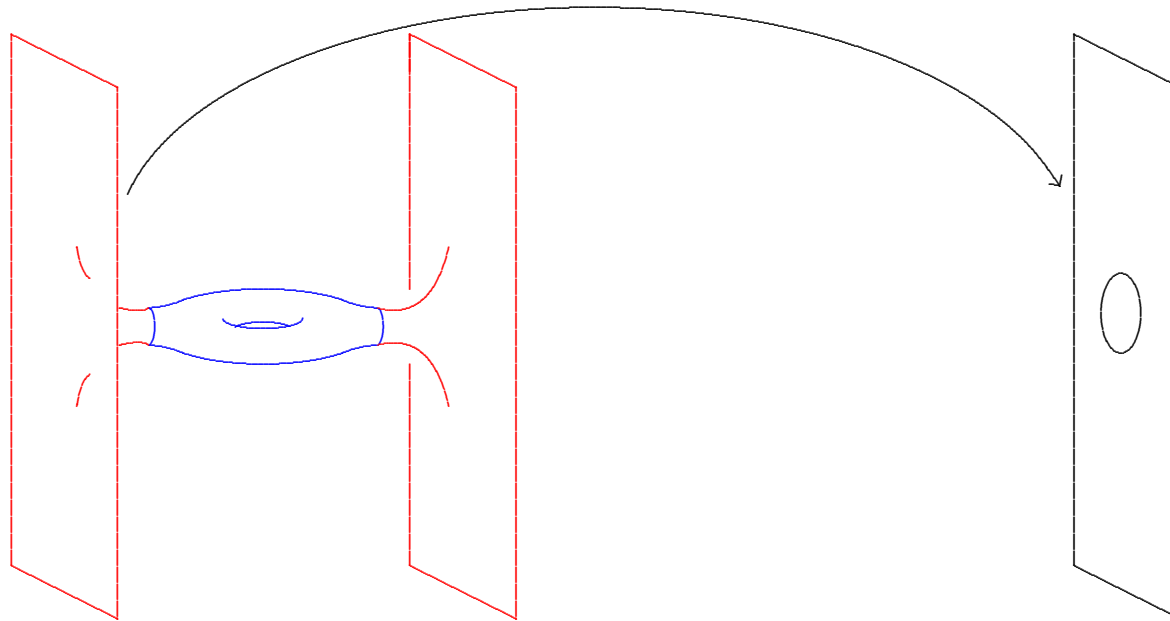

$$g_{jk} = \delta_{jk} + O(|x|^{1-\frac{n}{2}-\varepsilon})$$

$$g_{jk,\ell} = O(|x|^{-\frac{n}{2}-\varepsilon}), \quad s \in L^1$$

**Definition.** A complete, non-compact Riemannian  $n$ -manifold  $(M^n, g)$  is called **asymptotically Euclidean (AE)** if there is a compact set  $K \subset M$  such that each component of  $M - K$  is diffeomorphic to  $\mathbb{R}^n - D^n$  in such a manner that

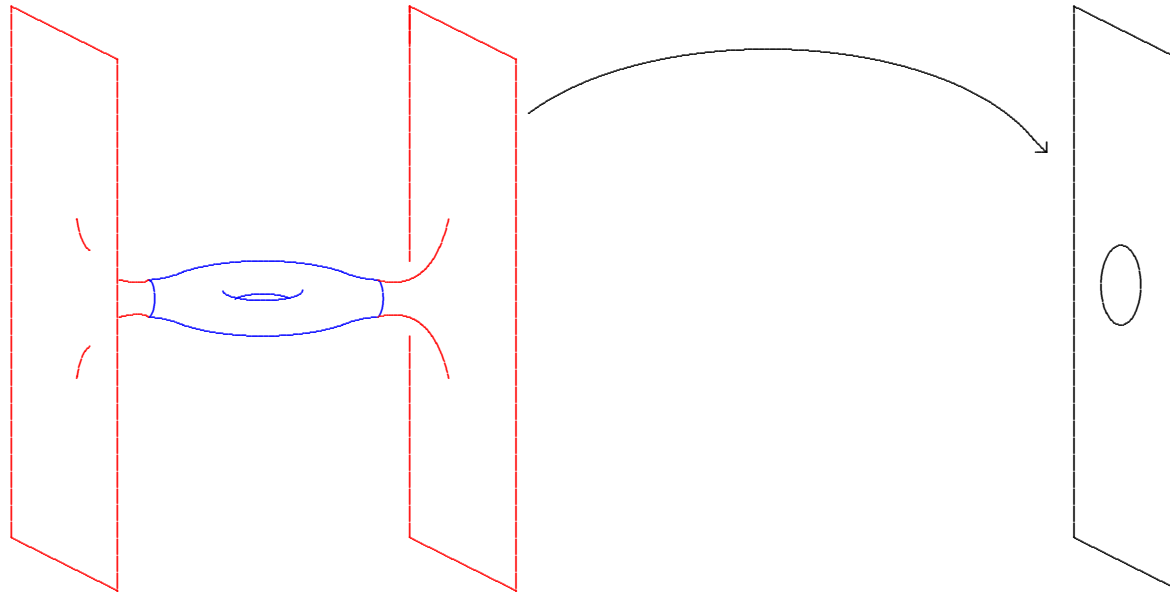

$$g_{jk} = \delta_{jk} + O(|x|^{1-\frac{n}{2}-\varepsilon})$$

$$g_{jk,\ell} = O(|x|^{-\frac{n}{2}-\varepsilon}), \quad s \in L^1$$

**Definition.** A complete, non-compact Riemannian  $n$ -manifold  $(M^n, g)$  is called **asymptotically Euclidean (AE)** if there is a compact set  $K \subset M$  such that each “end” is diffeomorphic to  $\mathbb{R}^n - D^n$  in such a manner that

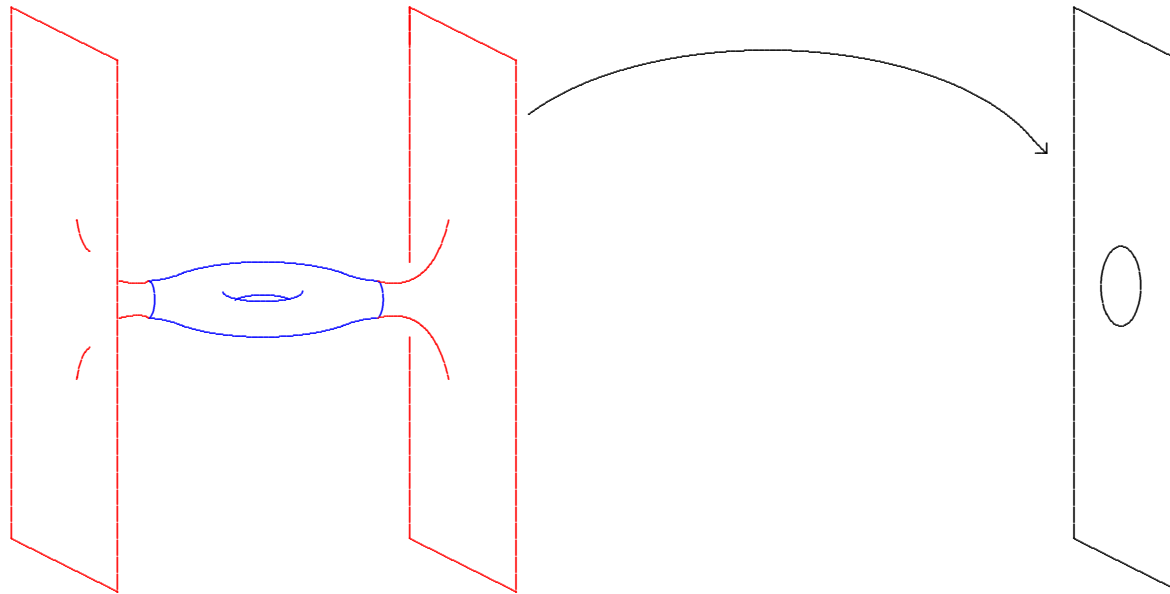

$$g_{jk} = \delta_{jk} + O(|x|^{1-\frac{n}{2}-\varepsilon})$$

$$g_{jk,\ell} = O(|x|^{-\frac{n}{2}-\varepsilon}), \quad s \in L^1$$

**Definition.** Complete, non-compact  $n$ -manifold  $(M^n, g)$  is asymptotically locally Euclidean

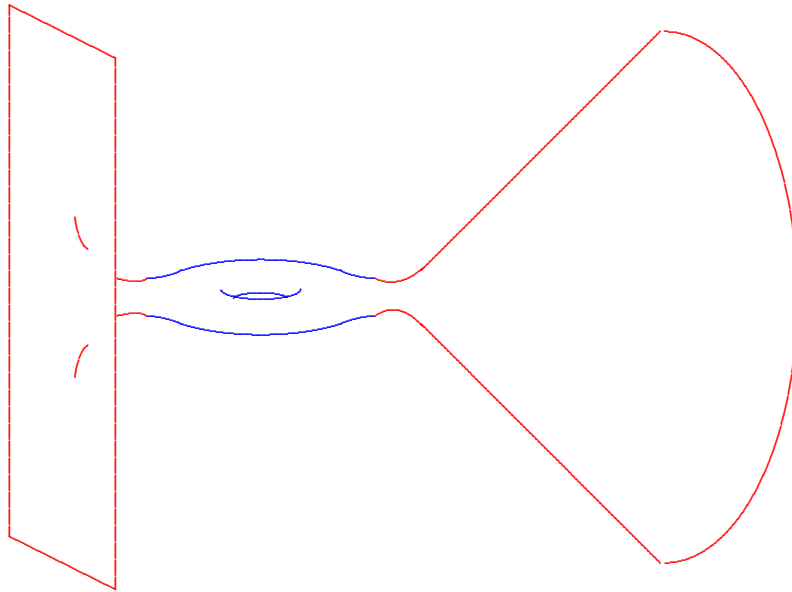



**Definition.** Complete, non-compact  $n$ -manifold  $(M^n, g)$  is asymptotically locally Euclidean (ALE)

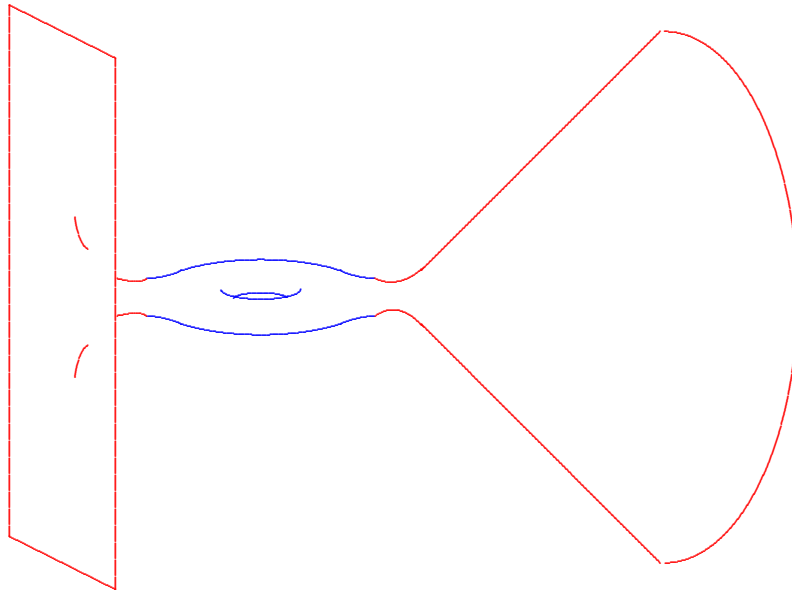

**Definition.** Complete, non-compact  $n$ -manifold  $(M^n, g)$  is asymptotically locally Euclidean (ALE) if  $\exists$  compact set  $K \subset M$

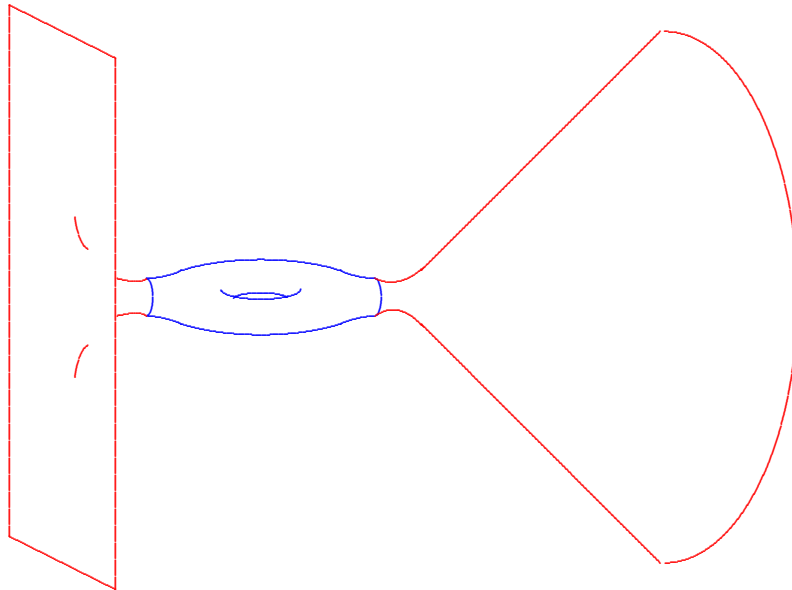

**Definition.** Complete, non-compact  $n$ -manifold  $(M^n, g)$  is asymptotically locally Euclidean (ALE) if  $\exists$  compact set  $K \subset M$  such that  $M - K \approx \coprod_i (\mathbb{R}^n - D^n) / \Gamma_i$ ,

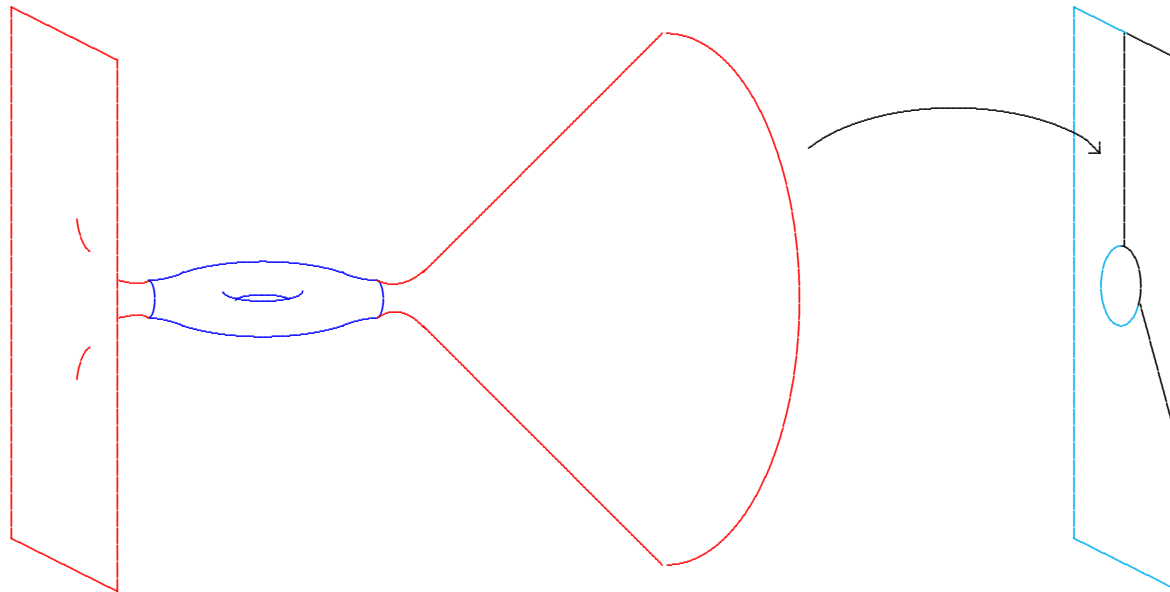

**Definition.** Complete, non-compact  $n$ -manifold  $(M^n, g)$  is asymptotically locally Euclidean (ALE) if  $\exists$  compact set  $K \subset M$  such that  $M - K \approx \coprod_i (\mathbb{R}^n - D^n) / \Gamma_i$ , where  $\Gamma_i \subset \mathbf{O}(n)$ ,

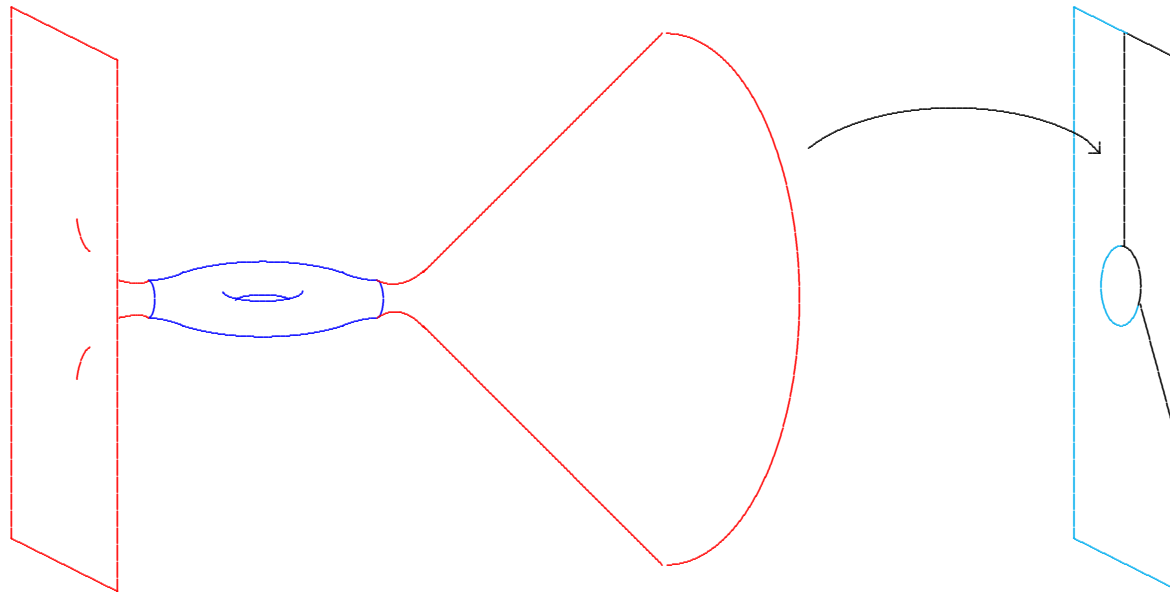

**Definition.** Complete, non-compact  $n$ -manifold  $(M^n, g)$  is asymptotically locally Euclidean (ALE) if  $\exists$  compact set  $K \subset M$  such that  $M - K \approx \coprod_i (\mathbb{R}^n - D^n) / \Gamma_i$ , where  $\Gamma_i \subset \mathbf{O}(n)$ ,

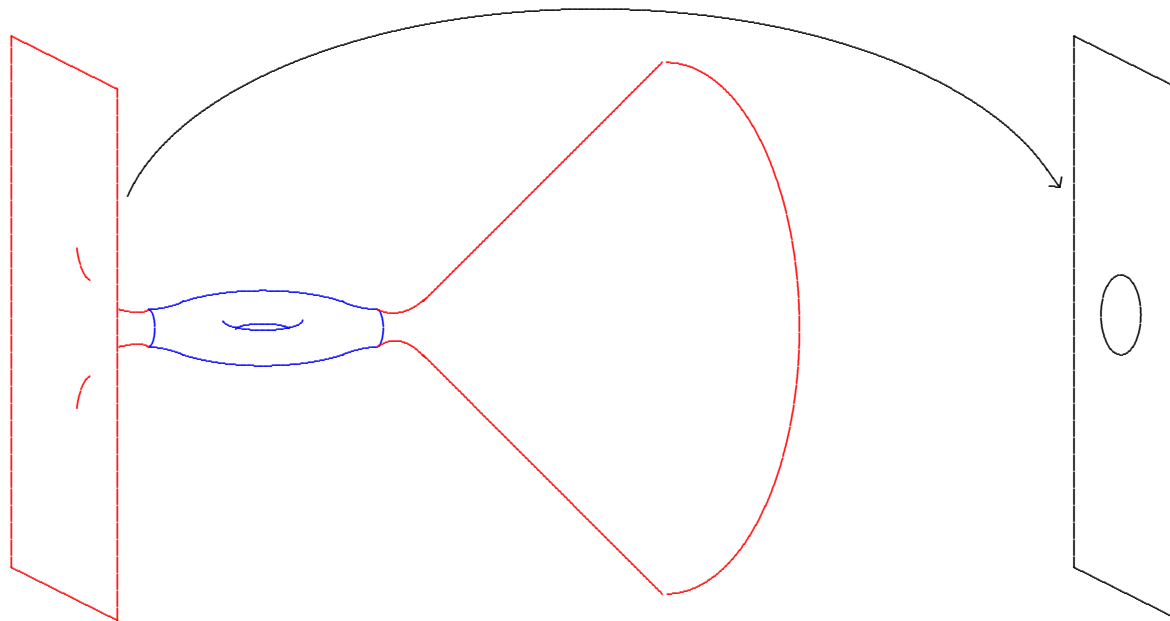

**Definition.** Complete, non-compact  $n$ -manifold  $(M^n, g)$  is asymptotically locally Euclidean (ALE) if  $\exists$  compact set  $K \subset M$  such that  $M - K \approx \coprod_i (\mathbb{R}^n - D^n) / \Gamma_i$ , where  $\Gamma_i \subset \mathbf{O}(n)$ ,

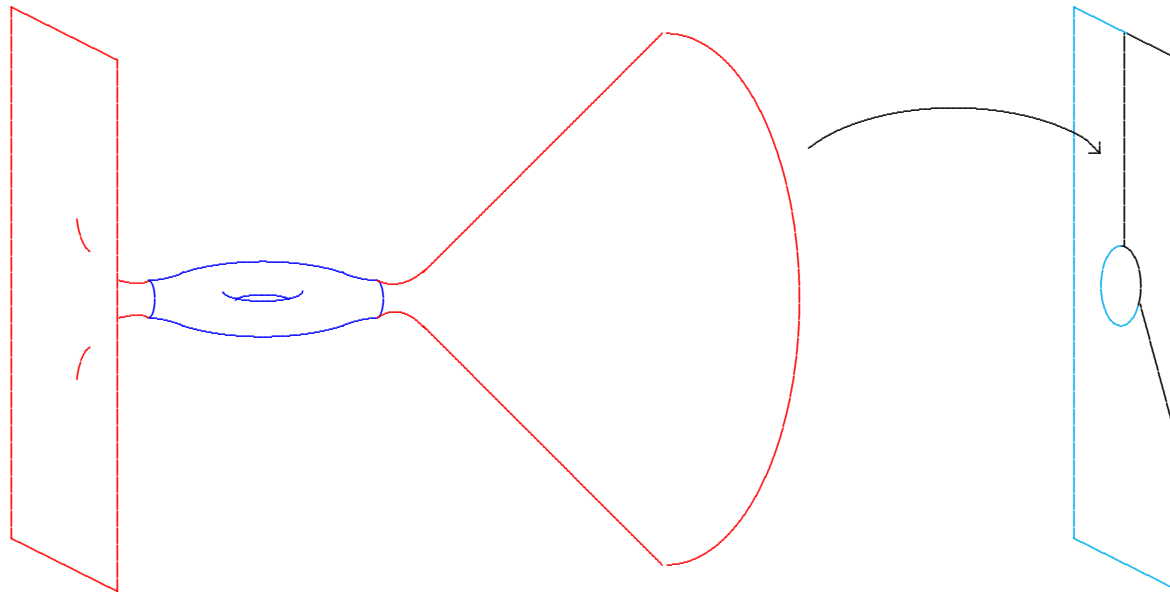

**Definition.** Complete, non-compact  $n$ -manifold  $(M^n, g)$  is asymptotically locally Euclidean (ALE) if  $\exists$  compact set  $K \subset M$  such that  $M - K \approx \coprod_i (\mathbb{R}^n - D^n) / \Gamma_i$ , where  $\Gamma_i \subset \mathbf{O}(n)$ , such that

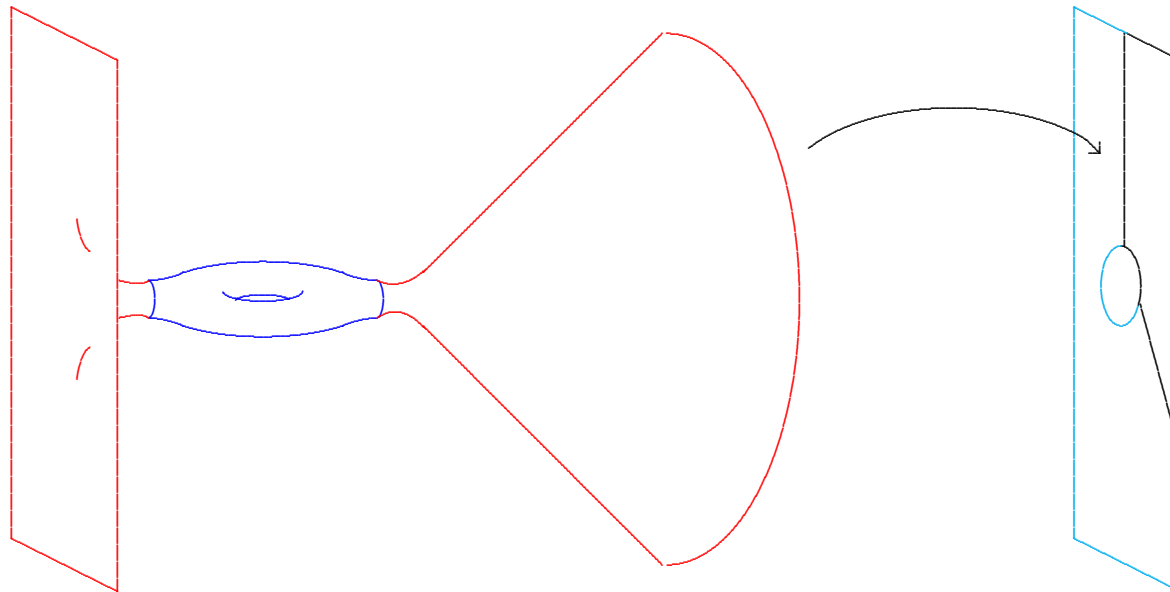

$$g_{jk} = \delta_{jk} + O(|x|^{1-\frac{n}{2}-\varepsilon})$$

$$g_{jk,\ell} = O(|x|^{-\frac{n}{2}-\varepsilon}), \quad s \in L^1$$

**Definition.** *The mass (at a given end) of an ALE  $n$ -manifold is defined to be*

$$m(M, g) := [g_{ij,i} - g_{ii,j}]$$



**Definition.** *The mass (at a given end) of an ALE  $n$ -manifold is defined to be*

$$m(M, g) := \int_{\partial M} [g_{ij,i} - g_{ii,j}] \nu^j$$

**Definition.** *The mass (at a given end) of an ALE  $n$ -manifold is defined to be*

$$m(M, g) := \int_{\Sigma(\varrho)} [g_{ij,i} - g_{ii,j}] \nu^j \alpha_E$$

**Definition.** *The mass (at a given end) of an ALE  $n$ -manifold is defined to be*

$$m(M, g) := \lim_{\varrho \rightarrow \infty} \int_{\Sigma(\varrho)} [g_{ij,i} - g_{ii,j}] \nu^j \alpha_E$$

**Definition.** *The mass (at a given end) of an ALE  $n$ -manifold is defined to be*

$$m(M, g) := \lim_{\varrho \rightarrow \infty} \frac{\Gamma(\frac{n}{2})}{4(n-1)\pi^{n/2}} \int_{\Sigma(\varrho)} [g_{ij,i} - g_{ii,j}] \nu^j \alpha_E$$

**Definition.** *The mass (at a given end) of an ALE  $n$ -manifold is defined to be*

$$m(M, g) := \lim_{\varrho \rightarrow \infty} \frac{\Gamma(\frac{n}{2})}{4(n-1)\pi^{n/2}} \int_{\Sigma(\varrho)} [g_{ij,i} - g_{ii,j}] \nu^j \alpha_E$$

where

**Definition.** The mass (at a given end) of an *ALE*  $n$ -manifold is defined to be

$$m(M, g) := \lim_{\varrho \rightarrow \infty} \frac{\Gamma(\frac{n}{2})}{4(n-1)\pi^{n/2}} \int_{\Sigma(\varrho)} [g_{ij,i} - g_{ii,j}] \nu^j \alpha_E$$

where

- $\Sigma(\varrho) \approx S^{n-1}/\Gamma_i$

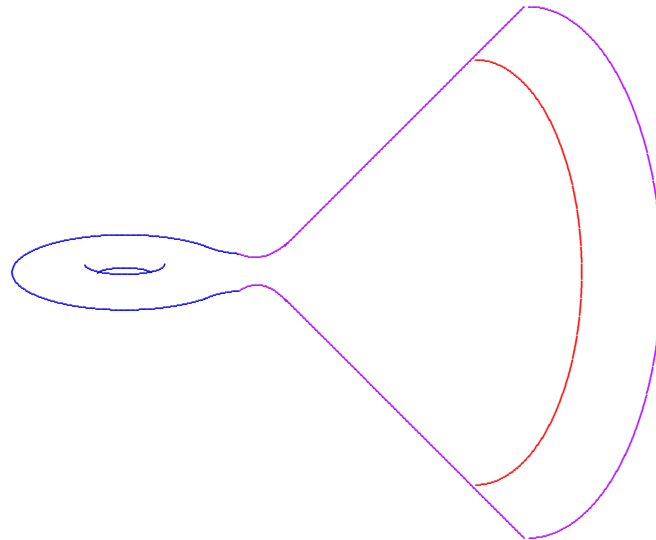

**Definition.** The mass (at a given end) of an *ALE*  $n$ -manifold is defined to be

$$m(M, g) := \lim_{\varrho \rightarrow \infty} \frac{\Gamma(\frac{n}{2})}{4(n-1)\pi^{n/2}} \int_{\Sigma(\varrho)} [g_{ij,i} - g_{ii,j}] \nu^j \alpha_E$$

where

- $\Sigma(\varrho) \approx S^{n-1}/\Gamma_i$  is given by  $|\vec{x}| = \varrho$ ;

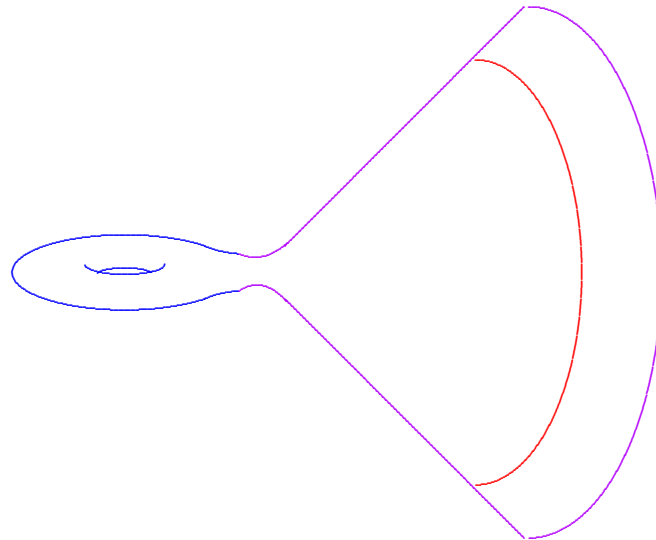

**Definition.** *The mass (at a given end) of an ALE  $n$ -manifold is defined to be*

$$m(M, g) := \lim_{\varrho \rightarrow \infty} \frac{\Gamma(\frac{n}{2})}{4(n-1)\pi^{n/2}} \int_{\Sigma(\varrho)} [g_{ij,i} - g_{ii,j}] \nu^j \alpha_E$$

where

- $\Sigma(\varrho) \approx S^{n-1}/\Gamma_i$  is given by  $|\vec{x}| = \varrho$ ;
- $\nu$  is the outpointing Euclidean unit normal;



**Definition.** *The mass (at a given end) of an ALE  $n$ -manifold is defined to be*

$$m(M, g) := \lim_{\varrho \rightarrow \infty} \frac{\Gamma(\frac{n}{2})}{4(n-1)\pi^{n/2}} \int_{\Sigma(\varrho)} [g_{ij,i} - g_{ii,j}] \nu^j \alpha_E$$

where

- $\Sigma(\varrho) \approx S^{n-1}/\Gamma_i$  is given by  $|\vec{x}| = \varrho$ ;
- $\nu$  is the outpointing Euclidean unit normal;  
and
- $\alpha_E$  is the volume  $(n-1)$ -form induced by the Euclidean metric.

**Definition.** *The mass (at a given end) of an ALE  $n$ -manifold is defined to be*

$$m(M, g) := \lim_{\varrho \rightarrow \infty} \frac{\Gamma(\frac{n}{2})}{4(n-1)\pi^{n/2}} \int_{\Sigma(\varrho)} [g_{ij,i} - g_{ii,j}] \nu^j \alpha_E$$

where

- $\Sigma(\varrho) \approx S^{n-1}/\Gamma_i$  is given by  $|\vec{x}| = \varrho$ ;
- $\nu$  is the outpointing Euclidean unit normal;  
and
- $\alpha_E$  is the volume  $(n-1)$ -form induced by the Euclidean metric.

---

**Bartnik/Chruściel (1986):** With weak fall-off conditions,

**Definition.** *The mass (at a given end) of an ALE  $n$ -manifold is defined to be*

$$m(M, g) := \lim_{\varrho \rightarrow \infty} \frac{\Gamma(\frac{n}{2})}{4(n-1)\pi^{n/2}} \int_{\Sigma(\varrho)} [g_{ij,i} - g_{ii,j}] \nu^j \alpha_E$$

where

- $\Sigma(\varrho) \approx S^{n-1}/\Gamma_i$  is given by  $|\vec{x}| = \varrho$ ;
- $\nu$  is the outpointing Euclidean unit normal;  
and
- $\alpha_E$  is the volume  $(n-1)$ -form induced by the Euclidean metric.

---

**Bartnik/Chruściel (1986):** With weak fall-off conditions, the mass is well-defined & coordinate independent.

**Definition.** *The mass (at a given end) of an ALE  $n$ -manifold is defined to be*

$$m(M, g) := \lim_{\varrho \rightarrow \infty} \frac{\Gamma(\frac{n}{2})}{4(n-1)\pi^{n/2}} \int_{\Sigma(\varrho)} [g_{ij,i} - g_{ii,j}] \nu^j \alpha_E$$

where

- $\Sigma(\varrho) \approx S^{n-1}/\Gamma_i$  is given by  $|\vec{x}| = \varrho$ ;
- $\nu$  is the outpointing Euclidean unit normal;  
and
- $\alpha_E$  is the volume  $(n-1)$ -form induced by the Euclidean metric.

---

**Chruściel (1986):**

**Definition.** *The mass (at a given end) of an ALE  $n$ -manifold is defined to be*

$$m(M, g) := \lim_{\varrho \rightarrow \infty} \frac{\Gamma(\frac{n}{2})}{4(n-1)\pi^{n/2}} \int_{\Sigma(\varrho)} [g_{ij,i} - g_{ii,j}] \nu^j \alpha_E$$

where

- $\Sigma(\varrho) \approx S^{n-1}/\Gamma_i$  is given by  $|\vec{x}| = \varrho$ ;
- $\nu$  is the outpointing Euclidean unit normal;  
and
- $\alpha_E$  is the volume  $(n-1)$ -form induced by the Euclidean metric.

$$g_{jk} = \delta_{jk} + O(|x|^{1-\frac{n}{2}-\varepsilon})$$

$$g_{jk,\ell} = O(|x|^{-\frac{n}{2}-\varepsilon}), \quad s \in L^1$$

Motivation:

## Motivation:

When  $n = 3$ , ADM mass in general relativity.

## Motivation:

When  $n = 3$ , ADM mass in general relativity.

Reads off “apparent mass” from strength of the gravitational field far from an isolated source.



## Motivation:

When  $n = 3$ , ADM mass in general relativity.

Reads off “apparent mass” from strength of the gravitational field far from an isolated source.

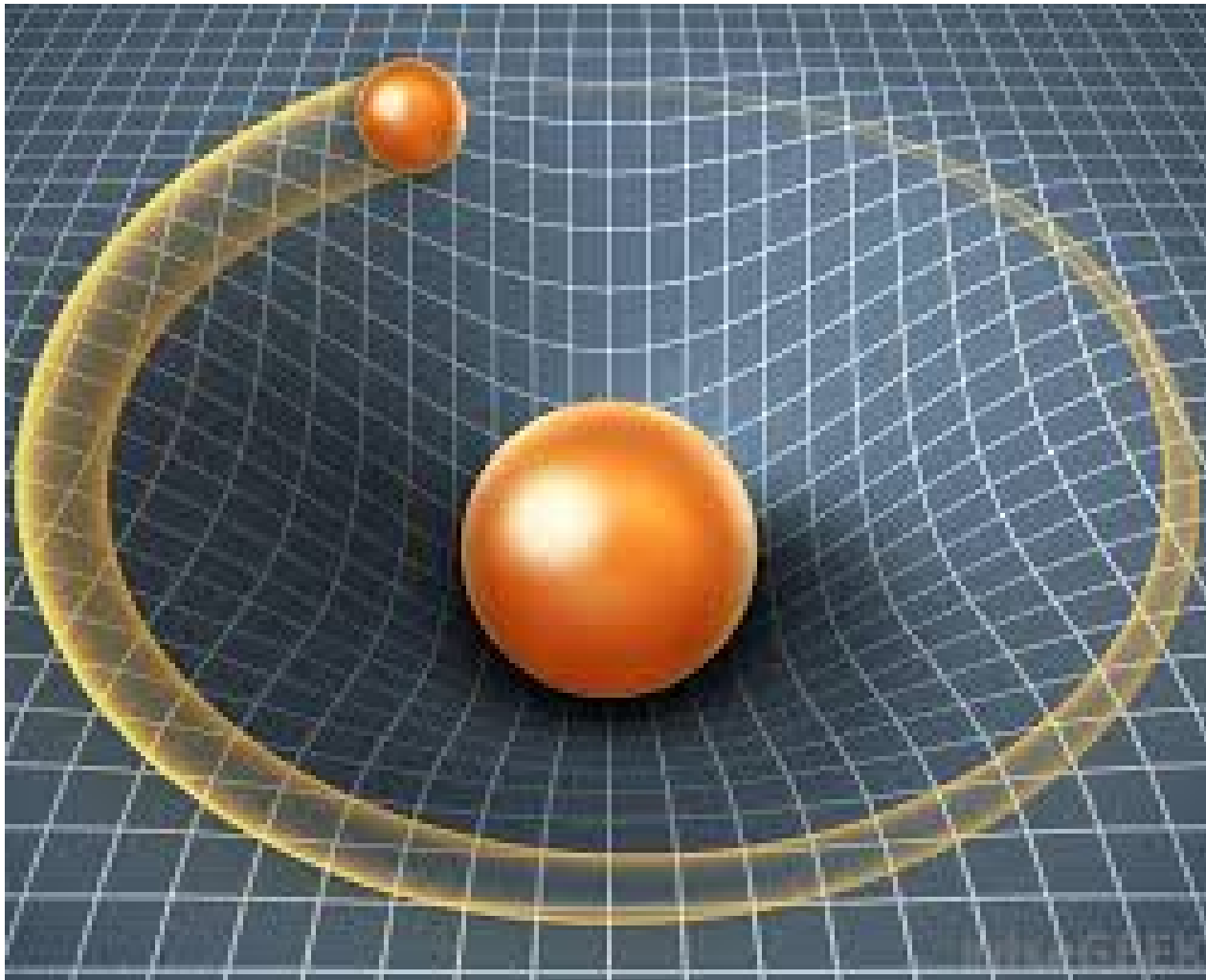

## Motivation:

When  $n = 3$ , ADM mass in general relativity.

Reads off “apparent mass” from strength of the gravitational field far from an isolated source.

## Motivation:

When  $n = 3$ , ADM mass in general relativity.

Reads off “apparent mass” from strength of the gravitational field far from an isolated source.

---

In any dimension, reproduces “mass” of  $t = 0$  hypersurface in  $(n + 1)$ -dimensional Schwarzschild

## Motivation:

When  $n = 3$ , ADM mass in general relativity.

Reads off “apparent mass” from strength of the gravitational field far from an isolated source.

---

In any dimension, reproduces “mass” of  $t = 0$  hypersurface in  $(n + 1)$ -dimensional Schwarzschild

$$g = - \left( 1 - \frac{2m}{\rho^{n-2}} \right) dt^2 + \left( 1 - \frac{2m}{\rho^{n-2}} \right)^{-1} d\rho^2 + \rho^2 h_{S^{n-1}}$$

## Motivation:

When  $n = 3$ , ADM mass in general relativity.

Reads off “apparent mass” from strength of the gravitational field far from an isolated source.

---

In any dimension, reproduces “mass” of  $t = 0$  hypersurface in  $(n + 1)$ -dimensional Schwarzschild

$$g = \left(1 - \frac{2m}{\varrho^{n-2}}\right)^{-1} d\varrho^2 + \varrho^2 h_{S^{n-1}}$$

## Motivation:

When  $n = 3$ , ADM mass in general relativity.

Reads off “apparent mass” from strength of the gravitational field far from an isolated source.

---

In any dimension, reproduces “mass” of  $t = 0$  hypersurface in  $(n + 1)$ -dimensional Schwarzschild

$$g = \left(1 - \frac{2m}{\varrho^{n-2}}\right)^{-1} d\varrho^2 + \varrho^2 h_{S^{n-1}}$$

Two such regions fit together to form the wormhole metric.

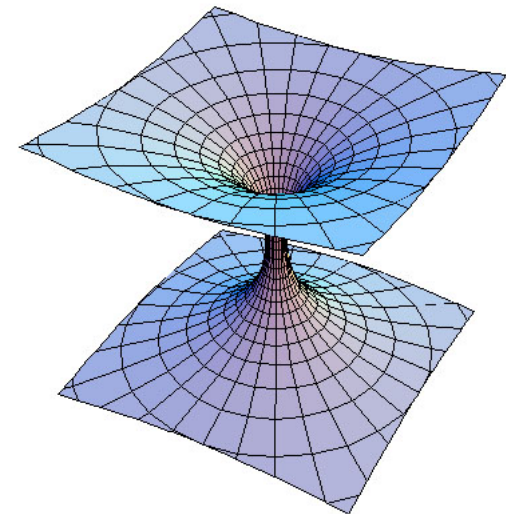

## Motivation:

When  $n = 3$ , ADM mass in general relativity.

Reads off “apparent mass” from strength of the gravitational field far from an isolated source.

---

In any dimension, reproduces “mass” of  $t = 0$  hypersurface in  $(n + 1)$ -dimensional Schwarzschild

$$g = \left(1 - \frac{2m}{\varrho^{n-2}}\right)^{-1} d\varrho^2 + \varrho^2 h_{S^{n-1}}$$

Two such regions fit together to form the wormhole metric. Scalar-flat, AE, two ends.

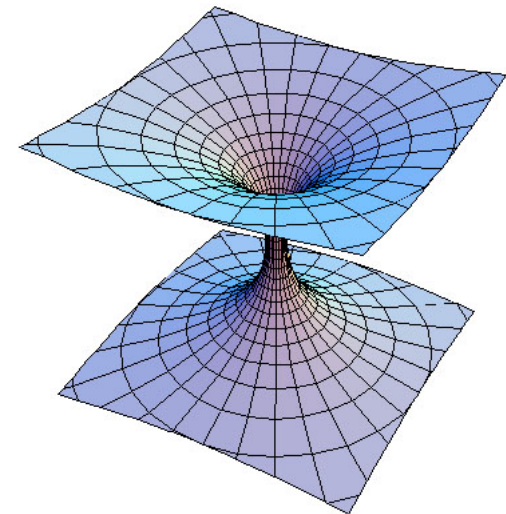

## Motivation:

When  $n = 3$ , ADM mass in general relativity.

Reads off “apparent mass” from strength of the gravitational field far from an isolated source.

---

In any dimension, reproduces “mass” of  $t = 0$  hypersurface in  $(n + 1)$ -dimensional Schwarzschild

$$g = \left(1 - \frac{2m}{\varrho^{n-2}}\right)^{-1} d\varrho^2 + \varrho^2 h_{S^{n-1}}$$

Two such regions fit together to form the wormhole metric. Scalar-flat, AE, two ends. Not Ricci-flat, but conformally flat.

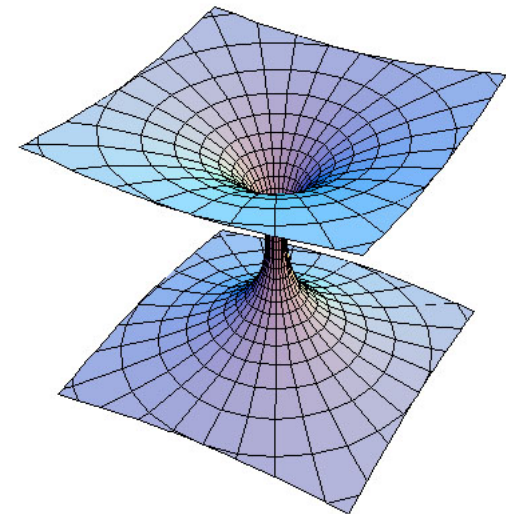



## Motivation:

When  $n = 3$ , ADM mass in general relativity.

Reads off “apparent mass” from strength of the gravitational field far from an isolated source.

---

In any dimension, reproduces “mass” of  $t = 0$  hypersurface in  $(n + 1)$ -dimensional Schwarzschild

$$g = \left(1 - \frac{2m}{\varrho^{n-2}}\right)^{-1} d\varrho^2 + \varrho^2 h_{S^{n-1}}$$

Two such regions fit together to form the wormhole metric. Scalar-flat, AE, two ends. Not Ricci-flat, but conformally flat. Same mass  $m$  at both ends:

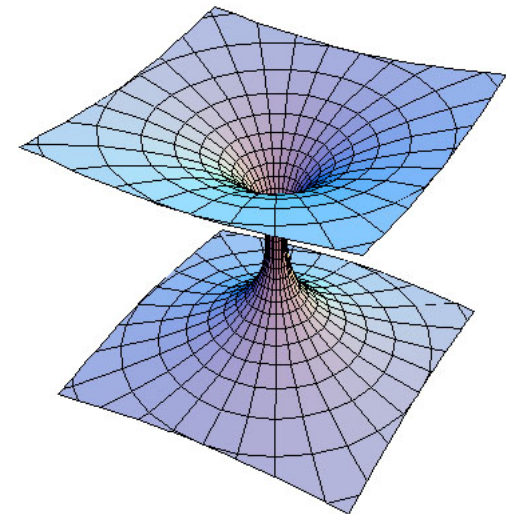

## Motivation:

When  $n = 3$ , ADM mass in general relativity.

Reads off “apparent mass” from strength of the gravitational field far from an isolated source.

---

In any dimension, reproduces “mass” of  $t = 0$  hypersurface in  $(n + 1)$ -dimensional Schwarzschild

$$g = \left(1 - \frac{2m}{\varrho^{n-2}}\right)^{-1} d\varrho^2 + \varrho^2 h_{S^{n-1}}$$

Two such regions fit together to form the wormhole metric. Scalar-flat, AE, two ends. Not Ricci-flat, but conformally flat. Same mass  $m$  at both ends: “size of throat.”

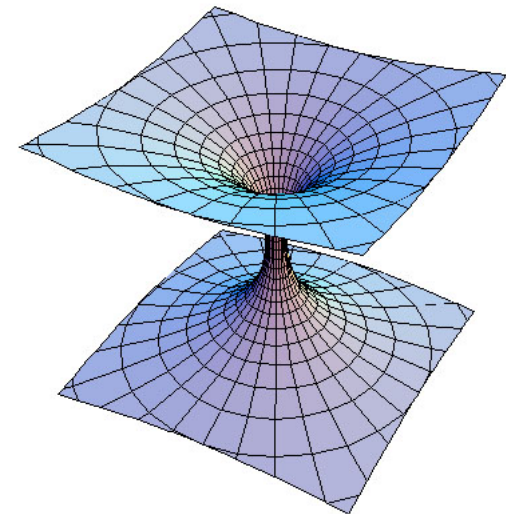

## Motivation:

When  $n = 3$ , ADM mass in general relativity.

Reads off “apparent mass” from strength of the gravitational field far from an isolated source.

---

In any dimension, reproduces “mass” of  $t = 0$  hypersurface in  $(n + 1)$ -dimensional Schwarzschild

$$g = \left( 1 + \frac{m/2}{r^{n-2}} \right)^{4/(n-2)} \left[ \sum (dx^j)^2 \right]$$

Two such regions fit together to form the wormhole metric. Scalar-flat, AE, two ends. Not Ricci-flat, but conformally flat. Same mass  $m$  at both ends: “size of throat.”

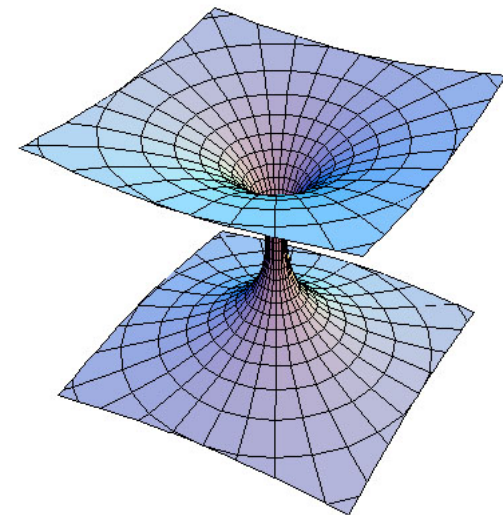

## Motivation:

When  $n = 3$ , ADM mass in general relativity.

Reads off “apparent mass” from strength of the gravitational field far from an isolated source.

---

In any dimension, reproduces “mass”  $m$  for

$$g_{jk} = \left( 1 + \frac{2m}{(n-2)r^{n-2}} \right) \delta_{jk} + \dots$$

## Motivation:

When  $n = 3$ , ADM mass in general relativity.

Reads off “apparent mass” from strength of the gravitational field far from an isolated source.

---

In any dimension, reproduces “mass”  $m$  for

$$g_{jk} = \left( 1 + \frac{2m}{(n-2)r^{n-2}} \right) \delta_{jk} + \dots$$

But notice that this crude model for the mass in particular assumes faster metric fall-off!

## Motivation:

When  $n = 3$ , ADM mass in general relativity.

Reads off “apparent mass” from strength of the gravitational field far from an isolated source.

---

In any dimension, reproduces “mass” of  $t = 0$  hypersurface in  $(n + 1)$ -dimensional Schwarzschild

$$g = \left(1 - \frac{2m}{\varrho^{n-2}}\right)^{-1} d\varrho^2 + \varrho^2 h_{S^{n-1}}$$

## Motivation:

When  $n = 3$ , ADM mass in general relativity.

Reads off “apparent mass” from strength of the gravitational field far from an isolated source.

---

In any dimension, reproduces “mass” of  $t = 0$  hypersurface in  $(n + 1)$ -dimensional Schwarzschild

$$g = \left(1 - \frac{2m}{\varrho^{n-2}}\right)^{-1} d\varrho^2 + \varrho^2 h_{S^{n-1}}$$

---

Burns metric on  $\widetilde{\mathbb{C}^2}$

## Motivation:

When  $n = 3$ , ADM mass in general relativity.

Reads off “apparent mass” from strength of the gravitational field far from an isolated source.

---

In any dimension, reproduces “mass” of  $t = 0$  hypersurface in  $(n + 1)$ -dimensional Schwarzschild

$$g = \left(1 - \frac{2m}{\varrho^{n-2}}\right)^{-1} d\varrho^2 + \varrho^2 h_{S^{n-1}}$$

---

Burns metric on  $\widetilde{\mathbb{C}^2} \subset \mathbb{C}^2 \times \mathbb{C}P_1$



## Motivation:

When  $n = 3$ , ADM mass in general relativity.

Reads off “apparent mass” from strength of the gravitational field far from an isolated source.

---

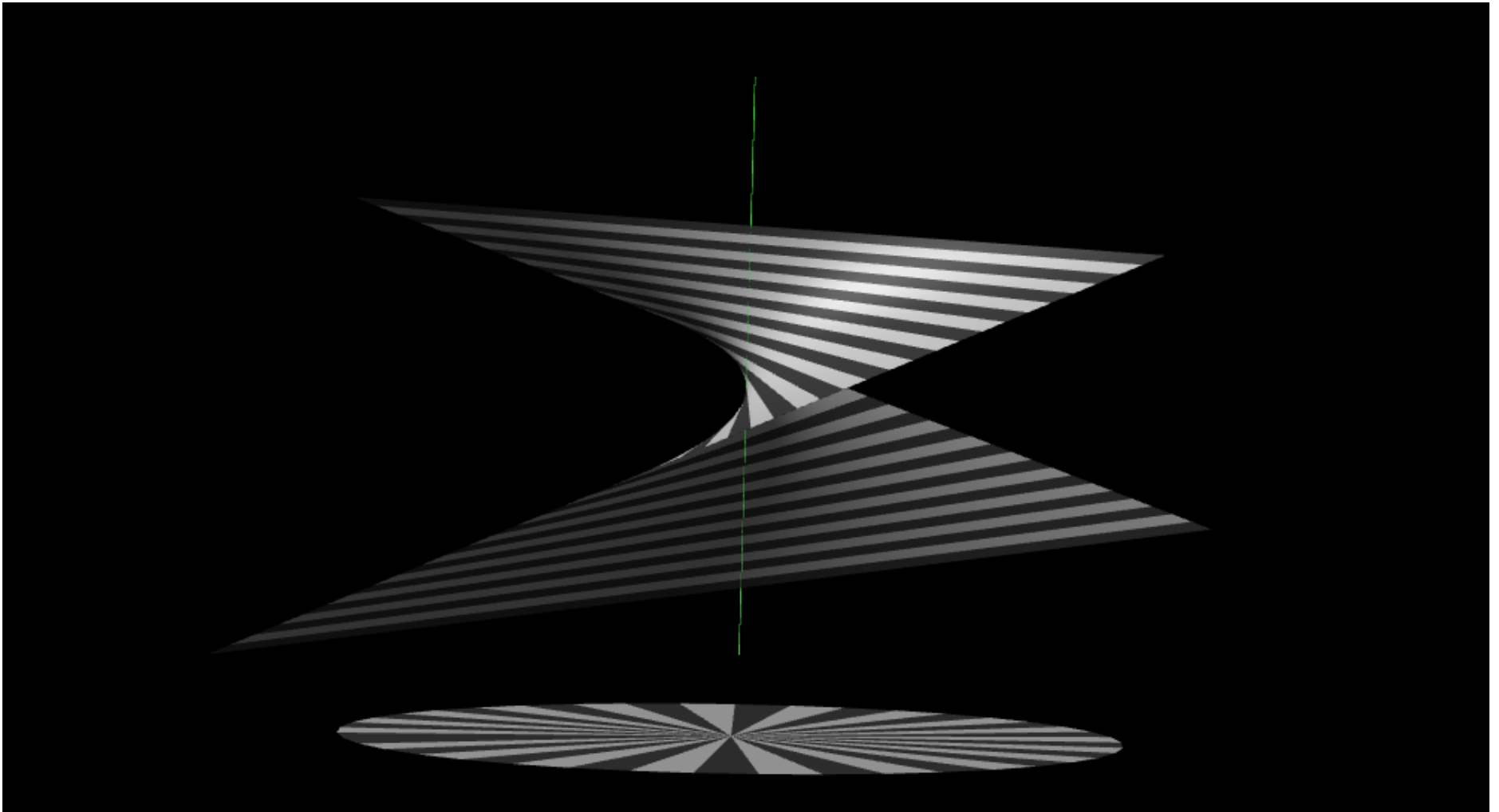

## Motivation:

When  $n = 3$ , ADM mass in general relativity.

Reads off “apparent mass” from strength of the gravitational field far from an isolated source.

---

In any dimension, reproduces “mass” of  $t = 0$  hypersurface in  $(n + 1)$ -dimensional Schwarzschild

$$g = \left(1 - \frac{2m}{\varrho^{n-2}}\right)^{-1} d\varrho^2 + \varrho^2 h_{S^{n-1}}$$

---

Burns metric on  $\widetilde{\mathbb{C}^2} \subset \mathbb{C}^2 \times \mathbb{C}P_1$

## Motivation:

When  $n = 3$ , ADM mass in general relativity.

Reads off “apparent mass” from strength of the gravitational field far from an isolated source.

---

In any dimension, reproduces “mass” of  $t = 0$  hypersurface in  $(n + 1)$ -dimensional Schwarzschild

$$g = \left(1 - \frac{2m}{\varrho^{n-2}}\right)^{-1} d\varrho^2 + \varrho^2 h_{S^{n-1}}$$

---

Scalar-flat-Kähler Burns metric on  $\widetilde{\mathbb{C}^2} \subset \mathbb{C}^2 \times \mathbb{C}P_1$

## Motivation:

When  $n = 3$ , ADM mass in general relativity.

Reads off “apparent mass” from strength of the gravitational field far from an isolated source.

---

In any dimension, reproduces “mass” of  $t = 0$  hypersurface in  $(n + 1)$ -dimensional Schwarzschild

$$g = \left(1 - \frac{2m}{\varrho^{n-2}}\right)^{-1} d\varrho^2 + \varrho^2 h_{S^{n-1}}$$

---

Scalar-flat-Kähler Burns metric on  $\widetilde{\mathbb{C}^2} \subset \mathbb{C}^2 \times \mathbb{CP}_1$ :

Restrict Euclidean  $\times$  round metric to  $\begin{vmatrix} z_1 & z_2 \\ \zeta_1 & \zeta_2 \end{vmatrix} = 0$ .

## Motivation:

When  $n = 3$ , ADM mass in general relativity.

Reads off “apparent mass” from strength of the gravitational field far from an isolated source.

---

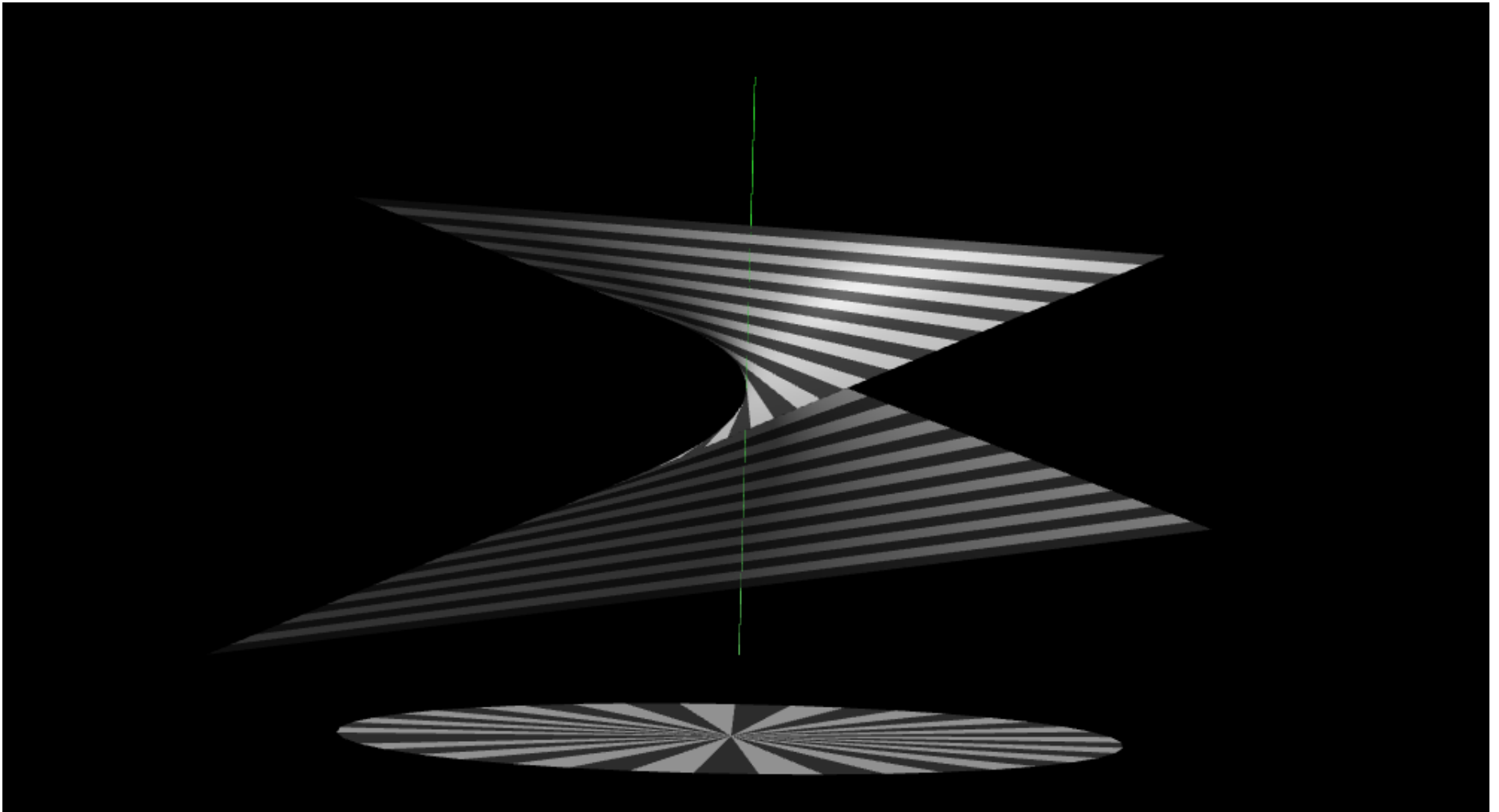

## Motivation:

When  $n = 3$ , ADM mass in general relativity.

Reads off “apparent mass” from strength of the gravitational field far from an isolated source.

---

In any dimension, reproduces “mass” of  $t = 0$  hypersurface in  $(n + 1)$ -dimensional Schwarzschild

$$g = \left(1 - \frac{2m}{\varrho^{n-2}}\right)^{-1} d\varrho^2 + \varrho^2 h_{S^{n-1}}$$

---

Scalar-flat-Kähler Burns metric on  $\widetilde{\mathbb{C}^2} \subset \mathbb{C}^2 \times \mathbb{CP}_1$ :

Restrict Euclidean  $\times$  round metric to  $\begin{vmatrix} z_1 & z_2 \\ \zeta_1 & \zeta_2 \end{vmatrix} = 0$ .

## Motivation:

When  $n = 3$ , ADM mass in general relativity.

Reads off “apparent mass” from strength of the gravitational field far from an isolated source.

---

In any dimension, reproduces “mass” of  $t = 0$  hypersurface in  $(n + 1)$ -dimensional Schwarzschild

$$g = \left(1 - \frac{2m}{\rho^{n-2}}\right)^{-1} d\rho^2 + \rho^2 h_{S^{n-1}}$$

---

Scalar-flat-Kähler Burns metric on  $\widetilde{\mathbb{C}^2} \subset \mathbb{C}^2 \times \mathbb{CP}_1$ :

$$\omega = \frac{i}{2} \partial \bar{\partial} [u + 3m \log u],$$

## Motivation:

When  $n = 3$ , ADM mass in general relativity.

Reads off “apparent mass” from strength of the gravitational field far from an isolated source.

---

In any dimension, reproduces “mass” of  $t = 0$  hypersurface in  $(n + 1)$ -dimensional Schwarzschild

$$g = \left(1 - \frac{2m}{\rho^{n-2}}\right)^{-1} d\rho^2 + \rho^2 h_{S^{n-1}}$$

---

Scalar-flat-Kähler Burns metric on  $\widetilde{\mathbb{C}^2} \subset \mathbb{C}^2 \times \mathbb{CP}_1$ :

$$\omega = \frac{i}{2} \partial \bar{\partial} [u + 3m \log u], \quad u = |z_1|^2 + |z_2|^2$$



## Motivation:

When  $n = 3$ , ADM mass in general relativity.

Reads off “apparent mass” from strength of the gravitational field far from an isolated source.

---

In any dimension, reproduces “mass” of  $t = 0$  hypersurface in  $(n + 1)$ -dimensional Schwarzschild

$$g = \left(1 - \frac{2m}{\varrho^{n-2}}\right)^{-1} d\varrho^2 + \varrho^2 h_{S^{n-1}}$$

---

Scalar-flat-Kähler Burns metric on  $\widetilde{\mathbb{C}^2} \subset \mathbb{C}^2 \times \mathbb{CP}_1$ :

$$\omega = \frac{i}{2} \partial \bar{\partial} [u + 3m \log u], \quad u = |z_1|^2 + |z_2|^2$$

also has mass  $m$ .

## Motivation:

When  $n = 3$ , ADM mass in general relativity.

Reads off “apparent mass” from strength of the gravitational field far from an isolated source.

---

In any dimension, reproduces “mass” of  $t = 0$  hypersurface in  $(n + 1)$ -dimensional Schwarzschild

$$g = \left(1 - \frac{2m}{\varrho^{n-2}}\right)^{-1} d\varrho^2 + \varrho^2 h_{S^{n-1}}$$

---

Scalar-flat-Kähler Burns metric on  $\widetilde{\mathbb{C}^2} \subset \mathbb{C}^2 \times \mathbb{CP}_1$ :

$$\omega = \frac{i}{2} \partial \bar{\partial} [u + 3m \log u], \quad u = |z_1|^2 + |z_2|^2$$

also has mass  $m$ . Again measures “size of throat.”

## Positive Mass Conjecture:

## Positive Mass Conjecture:

Any AE manifold

## Positive Mass Conjecture:

Any AE manifold with  $s \geq 0$

## Positive Mass Conjecture:

Any AE manifold with  $s \geq 0$  has  $m \geq 0$ .

## Positive Mass Conjecture:

Any AE manifold with  $s \geq 0$  has  $m \geq 0$ .

Physical intuition:

## Positive Mass Conjecture:

Any AE manifold with  $s \geq 0$  has  $m \geq 0$ .

## Physical intuition:

Local matter density  $\geq 0$



## Positive Mass Conjecture:

Any AE manifold with  $s \geq 0$  has  $m \geq 0$ .

## Physical intuition:

Local matter density  $\geq 0 \implies$  total mass  $\geq 0$ .

## Positive Mass Conjecture:

Any AE manifold with  $s \geq 0$  has  $m \geq 0$ .

## Positive Mass Conjecture:

Any AE manifold with  $s \geq 0$  has  $m \geq 0$ .

Schoen-Yau 1979:

## Positive Mass Conjecture:

Any AE manifold with  $s \geq 0$  has  $m \geq 0$ .

## Schoen-Yau 1979:

Proved in dimension  $n \leq 7$ .

## Positive Mass Conjecture:

Any AE manifold with  $s \geq 0$  has  $m \geq 0$ .

## Schoen-Yau 1979:

Proved in dimension  $n \leq 7$ .

## Witten 1981:

## Positive Mass Conjecture:

Any AE manifold with  $s \geq 0$  has  $m \geq 0$ .

## Schoen-Yau 1979:

Proved in dimension  $n \leq 7$ .

## Witten 1981:

Proved for spin manifolds

## Positive Mass Conjecture:

Any AE manifold with  $s \geq 0$  has  $m \geq 0$ .

## Schoen-Yau 1979:

Proved in dimension  $n \leq 7$ .

## Witten 1981:

Proved for spin manifolds (implicitly, for any  $n$ ).

## Positive Mass Conjecture:

Any AE manifold with  $s \geq 0$  has  $m \geq 0$ .

## Schoen-Yau 1979:

Proved in dimension  $n \leq 7$ .

## Witten 1981:

Proved for spin manifolds (implicitly, for any  $n$ ).

## Schoen-Yau 2018:



## Positive Mass Conjecture:

Any AE manifold with  $s \geq 0$  has  $m \geq 0$ .

### Schoen-Yau 1979:

Proved in dimension  $n \leq 7$ .

### Witten 1981:

Proved for spin manifolds (implicitly, for any  $n$ ).

### Schoen-Yau 2018:

General case in arbitrary dimension  $n$ .

## Positive Mass Conjecture:

Any AE manifold with  $s \geq 0$  has  $m \geq 0$ .

## Schoen-Yau 1979:

Proved in dimension  $n \leq 7$ .

## Witten 1981:

Proved for spin manifolds (implicitly, for any  $n$ ).

## Positive Mass Conjecture:

Any AE manifold with  $s \geq 0$  has  $m \geq 0$ .

## Schoen-Yau 1979:

Proved in dimension  $n \leq 7$ .

## Witten 1981:

Proved for spin manifolds (implicitly, for any  $n$ ).

## Hawking-Pope 1978:

## Positive Mass Conjecture:

Any AE manifold with  $s \geq 0$  has  $m \geq 0$ .

## Schoen-Yau 1979:

Proved in dimension  $n \leq 7$ .

## Witten 1981:

Proved for spin manifolds (implicitly, for any  $n$ ).

## Hawking-Pope 1978:

Conjectured true in ALE case, too.

## Positive Mass Conjecture:

Any AE manifold with  $s \geq 0$  has  $m \geq 0$ .

## Schoen-Yau 1979:

Proved in dimension  $n \leq 7$ .

## Witten 1981:

Proved for spin manifolds (implicitly, for any  $n$ ).

## Hawking-Pope 1978:

Conjectured true in ALE case, too.

## L 1986:

## Positive Mass Conjecture:

Any AE manifold with  $s \geq 0$  has  $m \geq 0$ .

## Schoen-Yau 1979:

Proved in dimension  $n \leq 7$ .

## Witten 1981:

Proved for spin manifolds (implicitly, for any  $n$ ).

## Hawking-Pope 1978:

Conjectured true in ALE case, too.

## L 1986:

ALE counter-examples.

## Positive Mass Conjecture:

Any AE manifold with  $s \geq 0$  has  $m \geq 0$ .

## Schoen-Yau 1979:

Proved in dimension  $n \leq 7$ .

## Witten 1981:

Proved for spin manifolds (implicitly, for any  $n$ ).

## Hawking-Pope 1978:

Conjectured true in ALE case, too.

## L 1986:

ALE counter-examples.

Scalar-flat Kähler metrics

## Positive Mass Conjecture:

Any AE manifold with  $s \geq 0$  has  $m \geq 0$ .

## Schoen-Yau 1979:

Proved in dimension  $n \leq 7$ .

## Witten 1981:

Proved for spin manifolds (implicitly, for any  $n$ ).

## Hawking-Pope 1978:

Conjectured true in ALE case, too.

## L 1986:

ALE counter-examples.

Scalar-flat Kähler metrics

on line bundles  $L \rightarrow \mathbb{C}P_1$  of Chern-class  $\leq -3$ .



In previous joint work with Hans-Joachim Hein

In previous joint work with Hans-Joachim Hein

Mass in Kähler Geometry

Comm. Math. Phys. 347 (2016) 621–653.

In previous joint work with Hans-Joachim Hein

Mass in Kähler Geometry

Comm. Math. Phys. 347 (2016) 621–653.

we deciphered the mass of ALE Kähler manifolds.

In previous joint work with Hans-Joachim Hein

Mass in Kähler Geometry

Comm. Math. Phys. 347 (2016) 621–653.

we deciphered the mass of ALE Kähler manifolds.

In complex dimension  $m \geq 3$ ,  
our results only required Chruściel fall-off.

In previous joint work with Hans-Joachim Hein

### Mass in Kähler Geometry

Comm. Math. Phys. 347 (2016) 621–653.

we deciphered the mass of ALE Kähler manifolds.

In complex dimension  $m \geq 3$ ,  
our results only required Chruściel fall-off.

$$g_{jk} - \delta_{jk} \in C^1_{-m+1-\varepsilon}, \quad s \in L^1$$

In previous joint work with Hans-Joachim Hein

### Mass in Kähler Geometry

Comm. Math. Phys. 347 (2016) 621–653.

we deciphered the mass of ALE Kähler manifolds.

In complex dimension  $m \geq 3$ ,  
our results only required Chruściel fall-off.

However, in complex dimension  $m = 2$ ,  
we needed stronger Bartnik-type fall-off

$$g_{jk} - \delta_{jk} \in C_{-1-\varepsilon}^{2,\alpha}, \quad s \in L^1$$

In previous joint work with Hans-Joachim Hein

### Mass in Kähler Geometry

Comm. Math. Phys. 347 (2016) 621–653.

we deciphered the mass of ALE Kähler manifolds.

In complex dimension  $m \geq 3$ ,  
our results only required Chruściel fall-off.

However, in complex dimension  $m = 2$ ,  
we needed stronger Bartnik-type fall-off

$$g_{jk} - \delta_{jk} \in C_{-1-\varepsilon}^{2,\alpha}, \quad s \in L^1$$

unless  $\varepsilon > \frac{1}{2}$ , when Chruściel fall-off sufficed.

This is rather unsatisfactory,



This is rather unsatisfactory, since real dimension four is the setting for many of the most interesting applications!

This is rather unsatisfactory, since real dimension four is the setting for many of the most interesting applications!

Fortunately, however, we will see today that

This is rather unsatisfactory, since real dimension four is the setting for many of the most interesting applications!

Fortunately, however, we will see today that

*Chruściel fall-off suffices to imply all the main results of Hein-L, even in real dimension four.*

This is rather unsatisfactory, since real dimension four is the setting for many of the most interesting applications!

Fortunately, however, we will see today that

*Chruściel fall-off suffices to imply all the main results of Hein-L, even in real dimension four.*

This entails new proofs in real dimension four that are based on results in symplectic geometry.

This is rather unsatisfactory, since real dimension four is the setting for many of the most interesting applications!

Fortunately, however, we will see today that

*Chruściel fall-off suffices to imply all the main results of Hein-L, even in real dimension four.*

This entails new proofs in real dimension four that are based on results in symplectic geometry.

In particular, Chruściel fall-off suffices to imply all the following results:

**Lemma.** *Any ALE Kähler manifold has only one end.*

**Lemma.** *Any ALE Kähler manifold has only one end.*

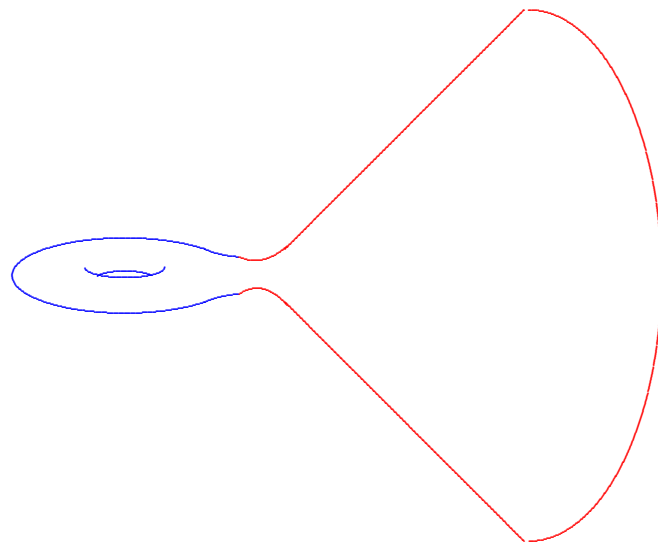

**Lemma.** *Any ALE Kähler manifold has only one end.*

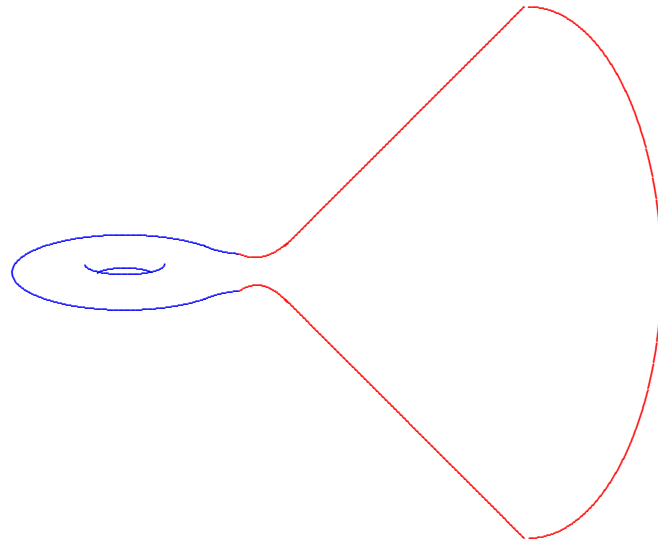

$$n = 2m \geq 4$$



**Lemma.** *Any ALE Kähler manifold has only one end.*

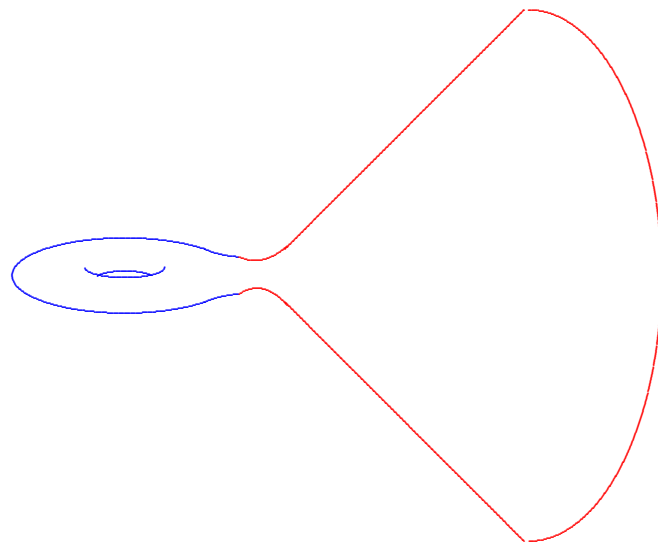

**Lemma.** *Any ALE Kähler manifold has only one end.*

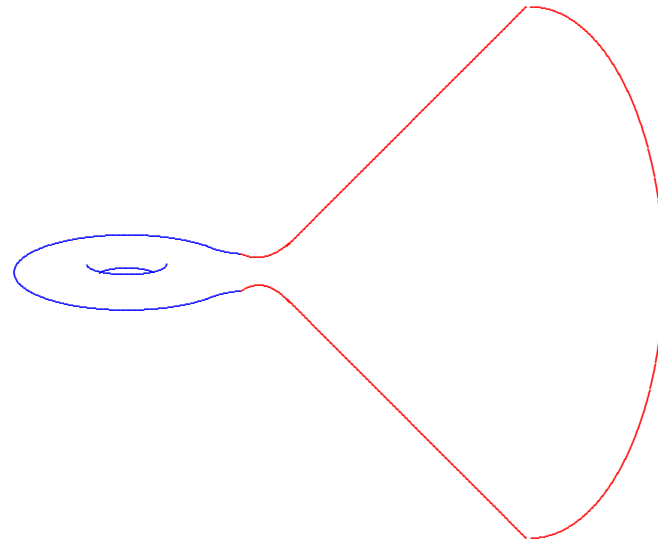

**Upshot:**

**Lemma.** *Any ALE Kähler manifold has only one end.*

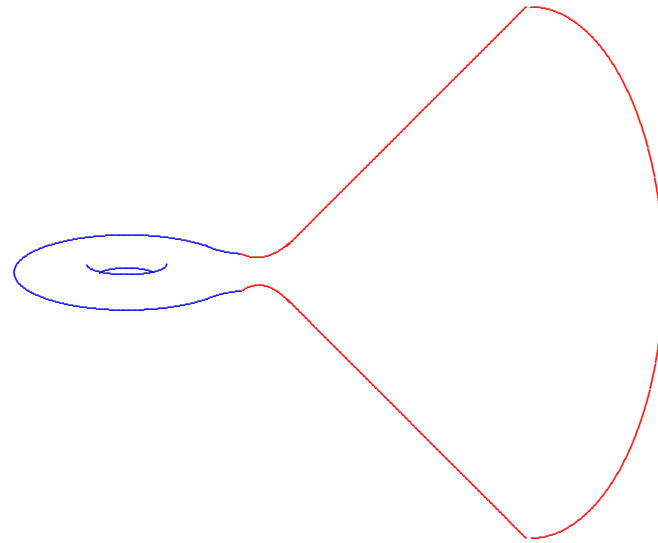

**Upshot:**

Mass of an ALE Kähler manifold is unambiguous.

**Lemma.** *Any ALE Kähler manifold has only one end.*

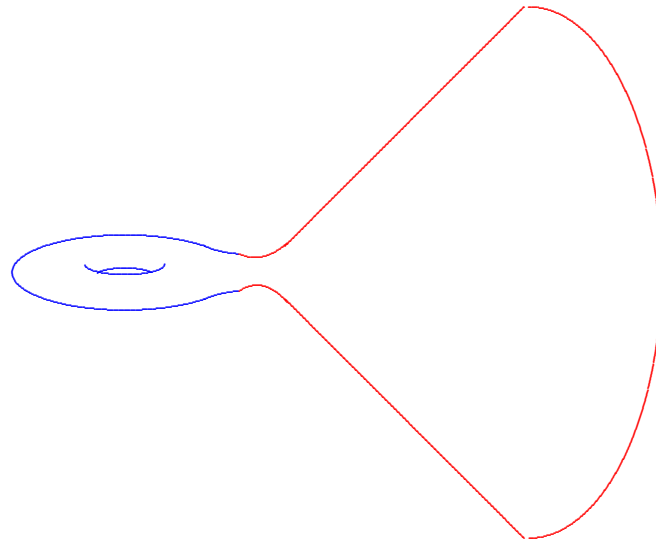

---

**Upshot:**

Mass of an ALE Kähler manifold is unambiguous.

Does not depend on the choice of an end!

## Theorem C.

**Theorem C.** *Any ALE Kähler manifold  $(M, g, J)$*

**Theorem C.** *Any ALE Kähler manifold  $(M, g, J)$  of complex dimension  $m$*

**Theorem C.** *Any ALE Kähler manifold  $(M, g, J)$  of complex dimension  $m$  has mass given by*



**Theorem C.** Any *ALE Kähler manifold*  $(M, g, J)$  of complex dimension  $m$  has mass given by

$$m(M, g) = \quad +$$

**Theorem C.** Any *ALE Kähler manifold*  $(M, g, J)$  of complex dimension  $n$  has mass given by

$$m(M, g) = \quad + \quad \int_M s_g d\mu_g$$

**Theorem C.** Any *ALE Kähler manifold*  $(M, g, J)$  of complex dimension  $m$  has mass given by

$$m(M, g) = + \frac{(m-1)!}{4(2m-1)\pi^m} \int_M s_g d\mu_g$$

**Theorem C.** Any *ALE Kähler manifold*  $(M, g, J)$  of complex dimension  $m$  has mass given by

$$m(M, g) = - \langle \clubsuit(c_1), [\omega]^{m-1} \rangle + \frac{(m-1)!}{4(2m-1)\pi^m} \int_M s_g d\mu_g$$

**Theorem C.** Any *ALE Kähler manifold*  $(M, g, J)$  of complex dimension  $m$  has mass given by

$$m(M, g) = -\frac{\langle \clubsuit(c_1), [\omega]^{m-1} \rangle}{(2m-1)\pi^{m-1}} + \frac{(m-1)!}{4(2m-1)\pi^m} \int_M s_g d\mu_g$$

**Theorem C.** Any *ALE Kähler manifold*  $(M, g, J)$  of complex dimension  $m$  has mass given by

$$m(M, g) = -\frac{\langle \clubsuit(c_1), [\omega]^{m-1} \rangle}{(2m-1)\pi^{m-1}} + \frac{(m-1)!}{4(2m-1)\pi^m} \int_M s_g d\mu_g$$

where

**Theorem C.** Any *ALE Kähler manifold*  $(M, g, J)$  of complex dimension  $m$  has mass given by

$$m(M, g) = -\frac{\langle \clubsuit(c_1), [\omega]^{m-1} \rangle}{(2m-1)\pi^{m-1}} + \frac{(m-1)!}{4(2m-1)\pi^m} \int_M s_g d\mu_g$$

where

- $s$  = scalar curvature;

**Theorem C.** Any *ALE Kähler manifold*  $(M, g, J)$  of complex dimension  $m$  has mass given by

$$m(M, g) = -\frac{\langle \clubsuit(c_1), [\omega]^{m-1} \rangle}{(2m-1)\pi^{m-1}} + \frac{(m-1)!}{4(2m-1)\pi^m} \int_M s_g d\mu_g$$

where

- $s$  = scalar curvature;
- $d\mu$  = metric volume form;



**Theorem C.** Any *ALE Kähler manifold*  $(M, g, J)$  of complex dimension  $m$  has mass given by

$$m(M, g) = -\frac{\langle \clubsuit(c_1), [\omega]^{m-1} \rangle}{(2m-1)\pi^{m-1}} + \frac{(m-1)!}{4(2m-1)\pi^m} \int_M s_g d\mu_g$$

where

- $s$  = scalar curvature;
- $d\mu$  = metric volume form;
- $c_1 = c_1(M, J) \in H^2(M)$  is first Chern class;

**Theorem C.** Any *ALE Kähler manifold*  $(M, g, J)$  of complex dimension  $m$  has mass given by

$$m(M, g) = -\frac{\langle \clubsuit(c_1), [\omega]^{m-1} \rangle}{(2m-1)\pi^{m-1}} + \frac{(m-1)!}{4(2m-1)\pi^m} \int_M s_g d\mu_g$$

where

- $s$  = scalar curvature;
- $d\mu$  = metric volume form;
- $c_1 = c_1(M, J) \in H^2(M)$  is first Chern class;
- $[\omega] \in H^2(M)$  is Kähler class of  $(g, J)$ ;

**Theorem C.** Any *ALE Kähler manifold*  $(M, g, J)$  of complex dimension  $m$  has mass given by

$$m(M, g) = -\frac{\langle \clubsuit(c_1), [\omega]^{m-1} \rangle}{(2m-1)\pi^{m-1}} + \frac{(m-1)!}{4(2m-1)\pi^m} \int_M s_g d\mu_g$$

where

- $s$  = scalar curvature;
- $d\mu$  = metric volume form;
- $c_1 = c_1(M, J) \in H^2(M)$  is first Chern class;
- $[\omega] \in H^2(M)$  is Kähler class of  $(g, J)$ ;
- $\langle \cdot, \cdot \rangle$  is pairing between  $H_c^2(M)$  and  $H^{2m-2}(M)$ ;

**Theorem C.** Any *ALE Kähler manifold*  $(M, g, J)$  of complex dimension  $m$  has mass given by

$$m(M, g) = -\frac{\langle \clubsuit(c_1), [\omega]^{m-1} \rangle}{(2m-1)\pi^{m-1}} + \frac{(m-1)!}{4(2m-1)\pi^m} \int_M s_g d\mu_g$$

where

- $s$  = scalar curvature;
- $d\mu$  = metric volume form;
- $c_1 = c_1(M, J) \in H^2(M)$  is first Chern class;
- $[\omega] \in H^2(M)$  is Kähler class of  $(g, J)$ ;
- $\langle , \rangle$  is pairing between  $H_c^2(M)$  and  $H^{2m-2}(M)$ ;
- $\clubsuit : H^2(M) \xrightarrow{\cong} H_c^2(M)$  inverse of natural map.

**Theorem C.** Any *ALE Kähler manifold*  $(M, g, J)$  of complex dimension  $m$  has mass given by

$$m(M, g) = -\frac{\langle \clubsuit(c_1), [\omega]^{m-1} \rangle}{(2m-1)\pi^{m-1}} + \frac{(m-1)!}{4(2m-1)\pi^m} \int_M s_g d\mu_g$$

$$m(M, g) = -\frac{\langle \clubsuit(c_1), [\omega]^{m-1} \rangle}{(2m-1)\pi^{m-1}} + \frac{(m-1)!}{4(2m-1)\pi^m} \int_M s_g d\mu_g$$

$$\frac{4\pi^m(2m-1)}{(m-1)!} \mathfrak{m}(M, g) = -\frac{4\pi}{(m-1)!} \langle \clubsuit(c_1), [\omega]^{m-1} \rangle + \int_M s_g d\mu_g$$

For a compact Kähler manifold  $(M^{2m}, g, J)$ ,

$$\int_M s_g d\mu_g = \frac{4\pi}{(m-1)!} \langle c_1, [\omega]^{m-1} \rangle$$



For a compact Kähler manifold  $(M^{2m}, g, J)$ ,

$$0 = -\frac{4\pi}{(m-1)!} \langle c_1, [\omega]^{m-1} \rangle + \int_M s_g d\mu_g$$

For an ALE Kähler manifold  $(M^{2m}, g, J)$ ,

$$\frac{4\pi^m(2m-1)}{(m-1)!} \mathfrak{m}(M, g) = -\frac{4\pi}{(m-1)!} \langle \clubsuit(c_1), [\omega]^{m-1} \rangle + \int_M s_g d\mu_g$$

For an ALE Kähler manifold  $(M^{2m}, g, J)$ ,

$$\frac{4\pi^m(2m-1)}{(m-1)!} m(M, g) = -\frac{4\pi}{(m-1)!} \langle \clubsuit(c_1), [\omega]^{m-1} \rangle + \int_M s_g d\mu_g$$

So the mass is a “boundary correction” to the topological formula for the total scalar curvature.

$$m(M, g) = -\frac{\langle \clubsuit(c_1), [\omega]^{m-1} \rangle}{(2m-1)\pi^{m-1}} + \frac{(m-1)!}{4(2m-1)\pi^m} \int_M s_g d\mu_g$$

**Theorem C.** Any *ALE Kähler manifold*  $(M, g, J)$  of complex dimension  $m$  has mass given by

$$m(M, g) = -\frac{\langle \clubsuit(c_1), [\omega]^{m-1} \rangle}{(2m-1)\pi^{m-1}} + \frac{(m-1)!}{4(2m-1)\pi^m} \int_M s_g d\mu_g$$

**Theorem C.** Any *ALE Kähler manifold*  $(M, g, J)$  of complex dimension  $m$  has mass given by

$$m(M, g) = -\frac{\langle \clubsuit(c_1), [\omega]^{m-1} \rangle}{(2m-1)\pi^{m-1}} + \frac{(m-1)!}{4(2m-1)\pi^m} \int_M s_g d\mu_g$$

New proof shows this follows from Chruściel fall-off.

**Theorem C.** Any *ALE Kähler manifold*  $(M, g, J)$  of complex dimension  $m$  has mass given by

$$m(M, g) = -\frac{\langle \clubsuit(c_1), [\omega]^{m-1} \rangle}{(2m-1)\pi^{m-1}} + \frac{(m-1)!}{4(2m-1)\pi^m} \int_M s_g d\mu_g$$

**Theorem C.** Any *ALE Kähler manifold*  $(M, g, J)$  of complex dimension  $m$  has mass given by

$$m(M, g) = -\frac{\langle \clubsuit(c_1), [\omega]^{m-1} \rangle}{(2m-1)\pi^{m-1}} + \frac{(m-1)!}{4(2m-1)\pi^m} \int_M s_g d\mu_g$$

In particular, this shows mass is coordinate-invariant, without ever invoking Bartnik-Chruściel!



**Theorem C.** Any ALE Kähler manifold  $(M, g, J)$  of complex dimension  $m$  has mass given by

$$m(M, g) = -\frac{\langle \clubsuit(c_1), [\omega]^{m-1} \rangle}{(2m-1)\pi^{m-1}} + \frac{(m-1)!}{4(2m-1)\pi^m} \int_M s_g d\mu_g$$

In particular, this shows mass is coordinate-invariant, without ever invoking Bartnik-Chruściel!

**Theorems A & B** are corollaries concerning scalar-flat Kähler metrics.



Another key consequence. . .



**Theorem E** (Penrose Inequality).

**Theorem E** (Penrose Inequality). *Let  $(M^{2m}, g, J)$  be an  $AE$  Kähler manifold*

**Theorem E** (Penrose Inequality). *Let  $(M^{2m}, g, J)$  be an  $AE$  Kähler manifold with scalar curvature  $s \geq 0$ .*

**Theorem E** (Penrose Inequality). *Let  $(M^{2m}, g, J)$  be an  $AE$  Kähler manifold with scalar curvature  $s \geq 0$ . Then  $(M, J)$  carries a canonical divisor  $D$*



**Theorem E** (Penrose Inequality). *Let  $(M^{2m}, g, J)$  be an  $AE$  Kähler manifold with scalar curvature  $s \geq 0$ . Then  $(M, J)$  carries a canonical divisor  $D$  that is expressed as a sum  $\sum_j \mathbf{n}_j D_j$  of compact complex hypersurfaces with positive integer coefficients,*

**Theorem E** (Penrose Inequality). *Let  $(M^{2m}, g, J)$  be an **AE** Kähler manifold with scalar curvature  $s \geq 0$ . Then  $(M, J)$  carries a canonical divisor  $D$  that is expressed as a sum  $\sum_j \mathbf{n}_j D_j$  of compact complex hypersurfaces with positive integer coefficients, with the property that  $\bigcup_j D_j \neq \emptyset$*

**Theorem E** (Penrose Inequality). *Let  $(M^{2m}, g, J)$  be an **AE** Kähler manifold with scalar curvature  $s \geq 0$ . Then  $(M, J)$  carries a canonical divisor  $D$  that is expressed as a sum  $\sum_j \mathbf{n}_j D_j$  of compact complex hypersurfaces with positive integer coefficients, with the property that  $\bigcup_j D_j \neq \emptyset$  whenever  $M \not\cong \mathbb{R}^{2m}$ .*

**Theorem E** (Penrose Inequality). *Let  $(M^{2m}, g, J)$  be an  $AE$  Kähler manifold with scalar curvature  $s \geq 0$ . Then  $(M, J)$  carries a canonical divisor  $D$  that is expressed as a sum  $\sum_j \mathbf{n}_j D_j$  of compact complex hypersurfaces with positive integer coefficients, with the property that  $\bigcup_j D_j \neq \emptyset$  whenever  $M \not\cong \mathbb{R}^{2m}$ . In terms of this divisor, we then have*

**Theorem E** (Penrose Inequality). *Let  $(M^{2m}, g, J)$  be an **AE** Kähler manifold with scalar curvature  $s \geq 0$ . Then  $(M, J)$  carries a canonical divisor  $D$  that is expressed as a sum  $\sum_j \mathbf{n}_j D_j$  of compact complex hypersurfaces with positive integer coefficients, with the property that  $\bigcup_j D_j \neq \emptyset$  whenever  $M \not\cong \mathbb{R}^{2m}$ . In terms of this divisor, we then have*

$$m(M, g) \geq \sum \text{Vol}(D_j)$$

**Theorem E** (Penrose Inequality). *Let  $(M^{2m}, g, J)$  be an **AE** Kähler manifold with scalar curvature  $s \geq 0$ . Then  $(M, J)$  carries a canonical divisor  $D$  that is expressed as a sum  $\sum_j \mathbf{n}_j D_j$  of compact complex hypersurfaces with positive integer coefficients, with the property that  $\bigcup_j D_j \neq \emptyset$  whenever  $M \not\cong \mathbb{R}^{2m}$ . In terms of this divisor, we then have*

$$m(M, g) \geq \frac{(m-1)!}{(2m-1)\pi^{m-1}} \sum \mathbf{n}_j \text{Vol}(D_j)$$

**Theorem E** (Penrose Inequality). *Let  $(M^{2m}, g, J)$  be an **AE** Kähler manifold with scalar curvature  $s \geq 0$ . Then  $(M, J)$  carries a canonical divisor  $D$  that is expressed as a sum  $\sum_j \mathbf{n}_j D_j$  of compact complex hypersurfaces with positive integer coefficients, with the property that  $\bigcup_j D_j \neq \emptyset$  whenever  $M \not\cong \mathbb{R}^{2m}$ . In terms of this divisor, we then have*

$$m(M, g) \geq \frac{(m-1)!}{(2m-1)\pi^{m-1}} \sum \mathbf{n}_j \text{Vol}(D_j)$$

*with  $= \iff (M, g, J)$  is scalar-flat Kähler.*

**Theorem E** (Penrose Inequality). *Let  $(M^{2m}, g, J)$  be an **AE** Kähler manifold with scalar curvature  $s \geq 0$ . Then  $(M, J)$  carries a canonical divisor  $D$  that is expressed as a sum  $\sum_j \mathbf{n}_j D_j$  of compact complex hypersurfaces with positive integer coefficients, with the property that  $\bigcup_j D_j \neq \emptyset$  whenever  $M \not\cong \mathbb{R}^{2m}$ . In terms of this divisor, we then have*

$$m(M, g) \geq \frac{(m-1)!}{(2m-1)\pi^{m-1}} \sum \mathbf{n}_j \text{Vol}(D_j)$$

*with  $= \iff (M, g, J)$  is scalar-flat Kähler.*

This has an interesting corollary...



**Theorem D** (Positive Mass Theorem).

**Theorem D** (Positive Mass Theorem). *Any  $AE$   
Kähler manifold with*

**Theorem D** (Positive Mass Theorem). *Any AE Kähler manifold with non-negative scalar curvature*

**Theorem D** (Positive Mass Theorem). *Any AE Kähler manifold with non-negative scalar curvature has non-negative mass:*

**Theorem D** (Positive Mass Theorem). *Any AE Kähler manifold with non-negative scalar curvature has non-negative mass:*

$$AE \ \& \ \text{Kähler} \ \& \ s \geq 0 \quad \implies \quad m(M, g) \geq 0.$$

**Theorem D** (Positive Mass Theorem). *Any AE Kähler manifold with non-negative scalar curvature has non-negative mass:*

$$AE \ \& \ \text{Kähler} \ \& \ s \geq 0 \quad \implies \quad m(M, g) \geq 0.$$

*Moreover,  $m = 0 \iff$*

**Theorem D** (Positive Mass Theorem). *Any AE Kähler manifold with non-negative scalar curvature has non-negative mass:*

$$AE \ \& \ \text{Kähler} \ \& \ s \geq 0 \implies m(M, g) \geq 0.$$

*Moreover,  $m = 0 \iff (M, g)$  is Euclidean space.*

**Theorem D** (Positive Mass Theorem). *Any AE Kähler manifold with non-negative scalar curvature has non-negative mass:*

$$AE \ \& \ Kähler \ \& \ s \geq 0 \implies m(M, g) \geq 0.$$

*Moreover,  $m = 0 \iff (M, g)$  is Euclidean space.*

Equality  $\implies$  Ricci-flat



**Theorem D** (Positive Mass Theorem). *Any AE Kähler manifold with non-negative scalar curvature has non-negative mass:*

$$AE \ \& \ \text{Kähler} \ \& \ s \geq 0 \implies m(M, g) \geq 0.$$

Moreover,  $m = 0 \iff (M, g)$  is Euclidean space.

Equality  $\implies$  Ricci-flat

because Ricci-form  $L^2$  harmonic and  $c_1 = 0$ .

**Theorem D** (Positive Mass Theorem). *Any AE Kähler manifold with non-negative scalar curvature has non-negative mass:*

$$AE \ \& \ \text{Kähler} \ \& \ s \geq 0 \implies m(M, g) \geq 0.$$

Moreover,  $m = 0 \iff (M, g)$  is Euclidean space.

Equality  $\implies$  Ricci-flat  
because Ricci-form  $L^2$  harmonic and  $c_1 = 0$ .

Now use Bishop-Gromov inequality.



Some applications ...



**Theorem C.** Any *ALE Kähler manifold*  $(M, g, J)$  of complex dimension  $m$  has mass given by

$$m(M, g) = -\frac{\langle \clubsuit(c_1), [\omega]^{m-1} \rangle}{(2m-1)\pi^{m-1}} + \frac{(m-1)!}{4(2m-1)\pi^m} \int_M s_g d\mu_g$$

**Corollary.** Any ALE scalar-flat Kähler manifold  $(M, g, J)$  of complex dimension  $m$  has mass given by

$$m(M, g) = -\frac{\langle \clubsuit(c_1), [\omega]^{m-1} \rangle}{(2m-1)\pi^{m-1}}.$$

**Corollary.** Any ALE scalar-flat Kähler manifold  $(M, g, J)$  of complex dimension  $m$  has mass given by

$$m(M, g) = -\frac{\langle \clubsuit(c_1), [\omega]^{m-1} \rangle}{(2m-1)\pi^{m-1}}.$$

**Example.** Blow up Chern class  $-\ell$  line bundle over  $\mathbb{C}P_1$  at  $k$  points on zero section  $\Sigma$ .

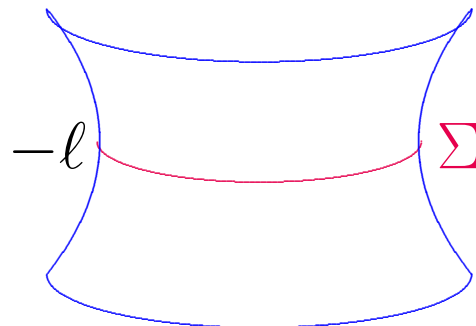



**Corollary.** Any ALE scalar-flat Kähler manifold  $(M, g, J)$  of complex dimension  $m$  has mass given by

$$m(M, g) = -\frac{\langle \clubsuit(c_1), [\omega]^{m-1} \rangle}{(2m-1)\pi^{m-1}}.$$

**Example.** Blow up Chern class  $-\ell$  line bundle over  $\mathbb{C}P_1$  at  $k$  points on zero section  $\Sigma$ .

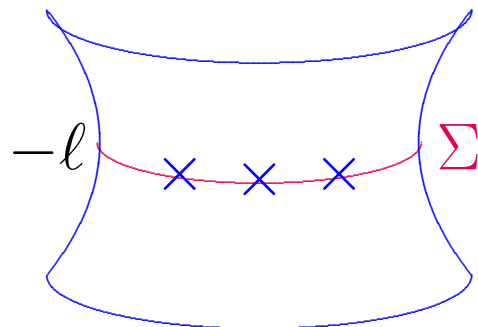

**Corollary.** Any ALE scalar-flat Kähler manifold  $(M, g, J)$  of complex dimension  $m$  has mass given by

$$m(M, g) = -\frac{\langle \clubsuit(c_1), [\omega]^{m-1} \rangle}{(2m-1)\pi^{m-1}}.$$

**Example.** Blow up Chern class  $-\ell$  line bundle over  $\mathbb{C}P_1$  at  $k$  points on zero section  $\Sigma$ .

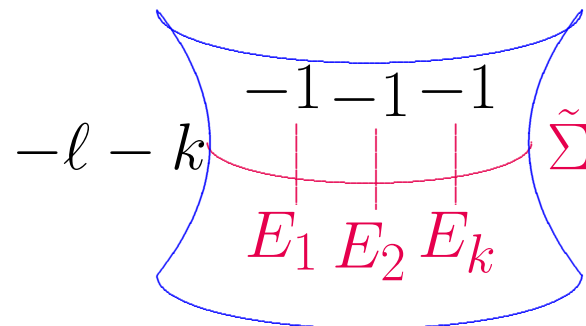

**Corollary.** Any ALE scalar-flat Kähler manifold  $(M, g, J)$  of complex dimension  $m$  has mass given by

$$m(M, g) = -\frac{\langle \clubsuit(c_1), [\omega]^{m-1} \rangle}{(2m-1)\pi^{m-1}}.$$

**Example.** Blow up Chern class  $-\ell$  line bundle over  $\mathbb{C}P_1$  at  $k$  points on zero section  $\Sigma$ .

$$m(M, g) = \frac{1}{3\pi\ell} \left[ (2-\ell) \int_{\tilde{\Sigma}} \omega \right].$$

**Corollary.** Any ALE scalar-flat Kähler manifold  $(M, g, J)$  of complex dimension  $m$  has mass given by

$$m(M, g) = -\frac{\langle \clubsuit(c_1), [\omega]^{m-1} \rangle}{(2m-1)\pi^{m-1}}.$$

**Example.** Blow up Chern class  $-\ell$  line bundle over  $\mathbb{C}P_1$  at  $k$  points on zero section  $\Sigma$ .

$$m(M, g) = \frac{1}{3\pi\ell} \left[ (2-\ell) \int_{\tilde{\Sigma}} \omega + 2 \sum_{j=1}^k \int_{E_j} \omega \right].$$

**Corollary.** Any ALE scalar-flat Kähler manifold  $(M, g, J)$  of complex dimension  $m$  has mass given by

$$m(M, g) = -\frac{\langle \clubsuit(c_1), [\omega]^{m-1} \rangle}{(2m-1)\pi^{m-1}}.$$

---

**Corollary.** Any ALE scalar-flat Kähler manifold  $(M, g, J)$  of complex dimension  $m$  has mass given by

$$m(M, g) = -\frac{\langle \clubsuit(c_1), [\omega]^{m-1} \rangle}{(2m-1)\pi^{m-1}}.$$

---

Similarly for the other available examples:

**Corollary.** Any ALE scalar-flat Kähler manifold  $(M, g, J)$  of complex dimension  $m$  has mass given by

$$m(M, g) = -\frac{\langle \clubsuit(c_1), [\omega]^{m-1} \rangle}{(2m-1)\pi^{m-1}}.$$

---

Similarly for the other available examples:

**L, Calderbank-Singer, Lock-Viaclovsky...**

**Corollary.** Any ALE scalar-flat Kähler manifold  $(M, g, J)$  of complex dimension  $m$  has mass given by

$$m(M, g) = -\frac{\langle \clubsuit(c_1), [\omega]^{m-1} \rangle}{(2m-1)\pi^{m-1}}.$$



**Theorem A.** *The mass of an ALE scalar-flat Kähler manifold is a topological invariant.*

**Theorem A.** *The mass of an ALE scalar-flat Kähler manifold is a topological invariant.*

*That is,  $m(M, g, J)$  is completely determined by*

- *the smooth manifold  $M$ ,*
- *the first Chern class  $c_1 = c_1(M, J) \in H^2(M)$  of the complex structure, and*
- *the Kähler class  $[\omega] \in H^2(M)$  of the metric.*

**Theorem A.** *The mass of an ALE scalar-flat Kähler manifold is a topological invariant.*

*That is,  $m(M, g, J)$  is completely determined by*

- *the smooth manifold  $M$ ,*
- *the first Chern class  $c_1 = c_1(M, J) \in H^2(M)$  of the complex structure, and*
- *the Kähler class  $[\omega] \in H^2(M)$  of the metric.*

**Theorem B.** *Let  $(M^4, g, J)$  be an ALE scalar-flat Kähler surface, and suppose that  $(M, J)$  is the minimal resolution of a surface singularity.*

**Theorem A.** *The mass of an ALE scalar-flat Kähler manifold is a topological invariant.*

*That is,  $m(M, g, J)$  is completely determined by*

- *the smooth manifold  $M$ ,*
- *the first Chern class  $c_1 = c_1(M, J) \in H^2(M)$  of the complex structure, and*
- *the Kähler class  $[\omega] \in H^2(M)$  of the metric.*

**Theorem B.** *Let  $(M^4, g, J)$  be an ALE scalar-flat Kähler surface, and suppose that  $(M, J)$  is the minimal resolution of a surface singularity. Then  $m(M, g) \leq 0$ ,*

**Theorem A.** *The mass of an ALE scalar-flat Kähler manifold is a topological invariant.*

*That is,  $m(M, g, J)$  is completely determined by*

- *the smooth manifold  $M$ ,*
- *the first Chern class  $c_1 = c_1(M, J) \in H^2(M)$  of the complex structure, and*
- *the Kähler class  $[\omega] \in H^2(M)$  of the metric.*

**Theorem B.** *Let  $(M^4, g, J)$  be an ALE scalar-flat Kähler surface, and suppose that  $(M, J)$  is the minimal resolution of a surface singularity. Then  $m(M, g) \leq 0$ , with  $=$  iff  $g$  is Ricci-flat.*

**Theorem C.** Any ALE Kähler manifold  $(M, g, J)$  of complex dimension  $m$  has mass given by

$$m(M, g) = -\frac{\langle \clubsuit(c_1), [\omega]^{m-1} \rangle}{(2m-1)\pi^{m-1}} + \frac{(m-1)!}{4(2m-1)\pi^m} \int_M s_g d\mu_g$$

In particular, this shows mass is coordinate-invariant, without ever invoking Bartnik-Chruściel!

**Theorems A & B** are corollaries concerning scalar-flat Kähler metrics.

**Theorem C.** Any ALE Kähler manifold  $(M, g, J)$  of complex dimension  $m$  has mass given by

$$m(M, g) = -\frac{\langle \clubsuit(c_1), [\omega]^{m-1} \rangle}{(2m-1)\pi^{m-1}} + \frac{(m-1)!}{4(2m-1)\pi^m} \int_M s_g d\mu_g$$

In particular, this shows mass is coordinate-invariant, without ever invoking Bartnik-Chruściel!

**Theorems A & B** are corollaries concerning scalar-flat Kähler metrics. But for such metrics, faster fall-off is guaranteed, so new proof is not actually needed!





How does one prove main results?



In high dimensions, the complex structure  $J$  of an ALE Kähler manifold is always standard at infinity.

In high dimensions, the complex structure  $J$  of an ALE Kähler manifold is always standard at infinity.

That is, there exist asymptotic complex coordinates.

In high dimensions, the complex structure  $J$  of an ALE Kähler manifold is always standard at infinity.

In high dimensions, the complex structure  $J$  of an ALE Kähler manifold is always standard at infinity.

This fails in real dimension 4.

In high dimensions, the complex structure  $J$  of an ALE Kähler manifold is always standard at infinity.

This fails in real dimension 4.

**Example:** Eguchi-Hanson.

In high dimensions, the complex structure  $J$  of an ALE Kähler manifold is always standard at infinity.

This fails in real dimension 4.

Example: Eguchi-Hanson.

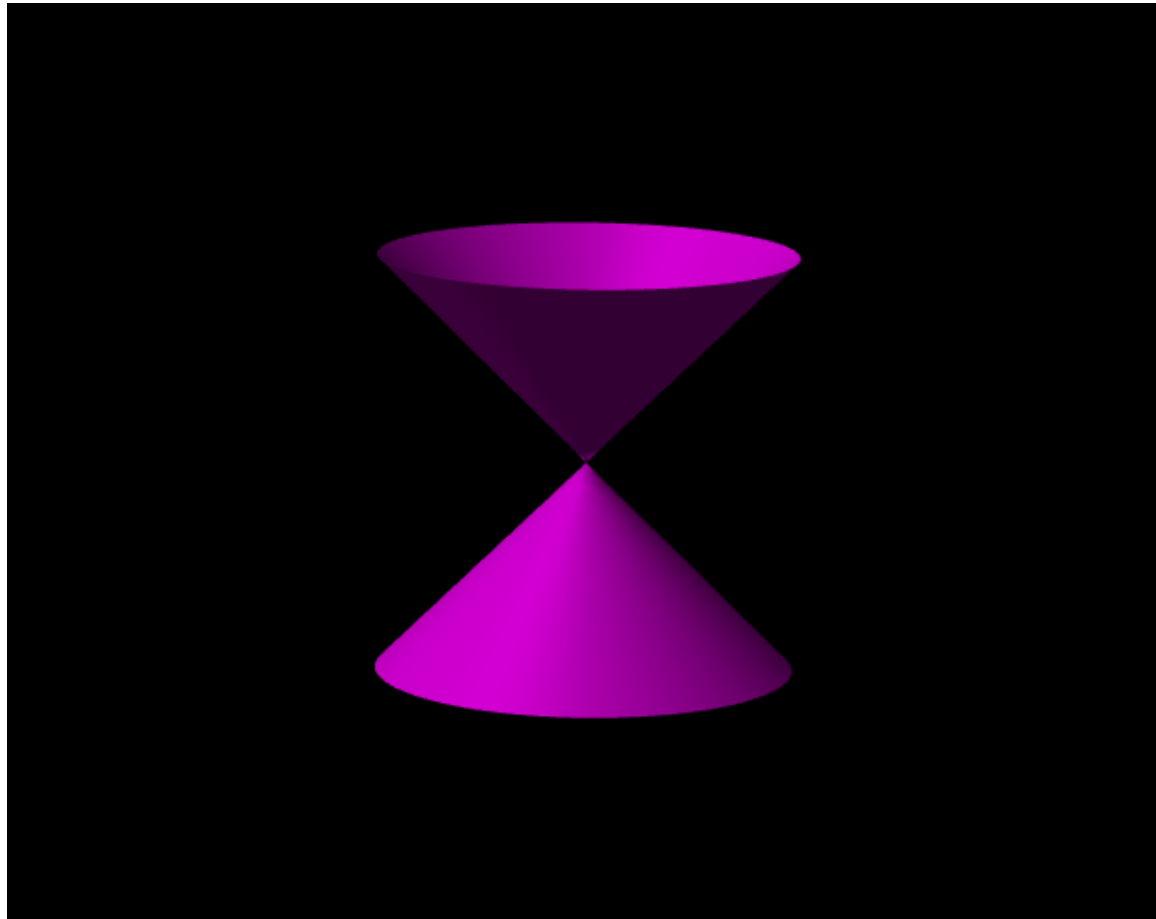



In high dimensions, the complex structure  $J$  of an ALE Kähler manifold is always standard at infinity.

This fails in real dimension 4.

Example: Eguchi-Hanson.

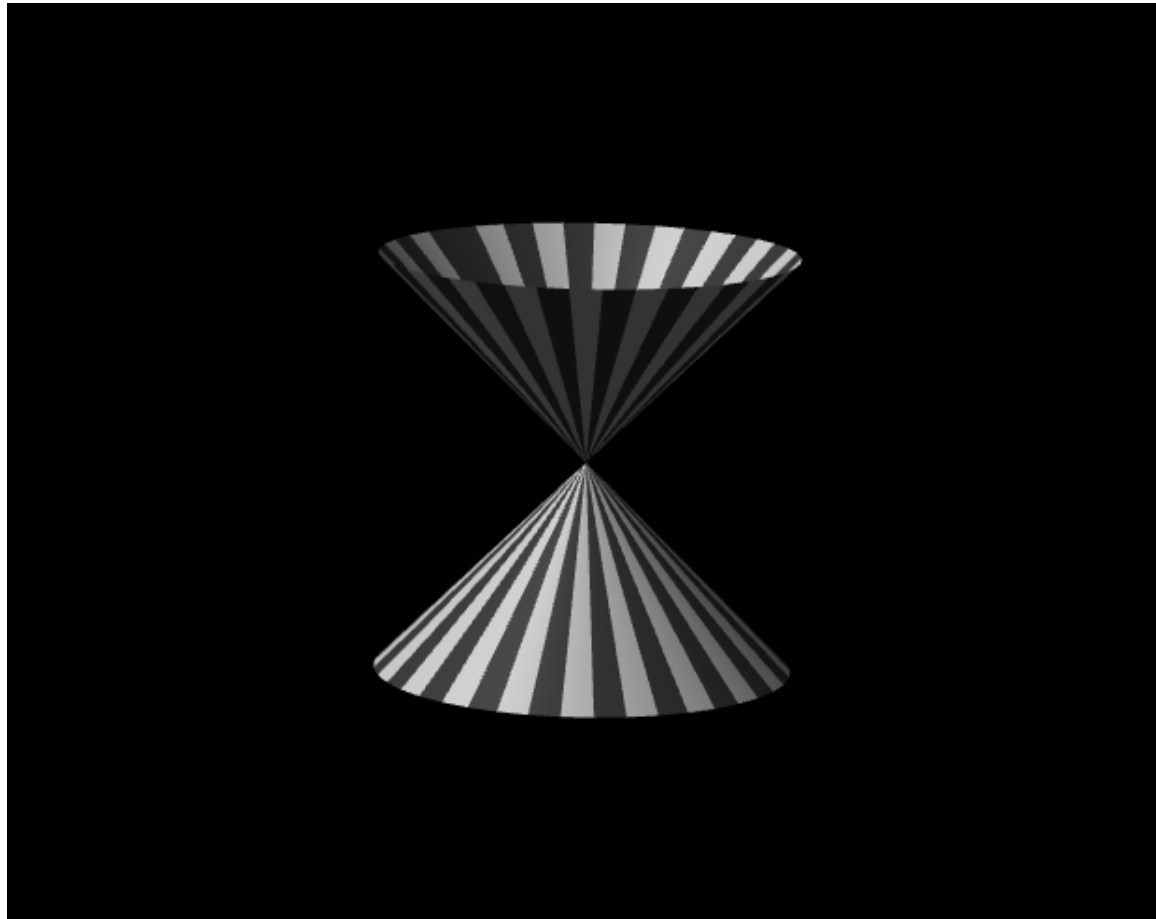

In high dimensions, the complex structure  $J$  of an ALE Kähler manifold is always standard at infinity.

This fails in real dimension 4.

Example: Eguchi-Hanson.

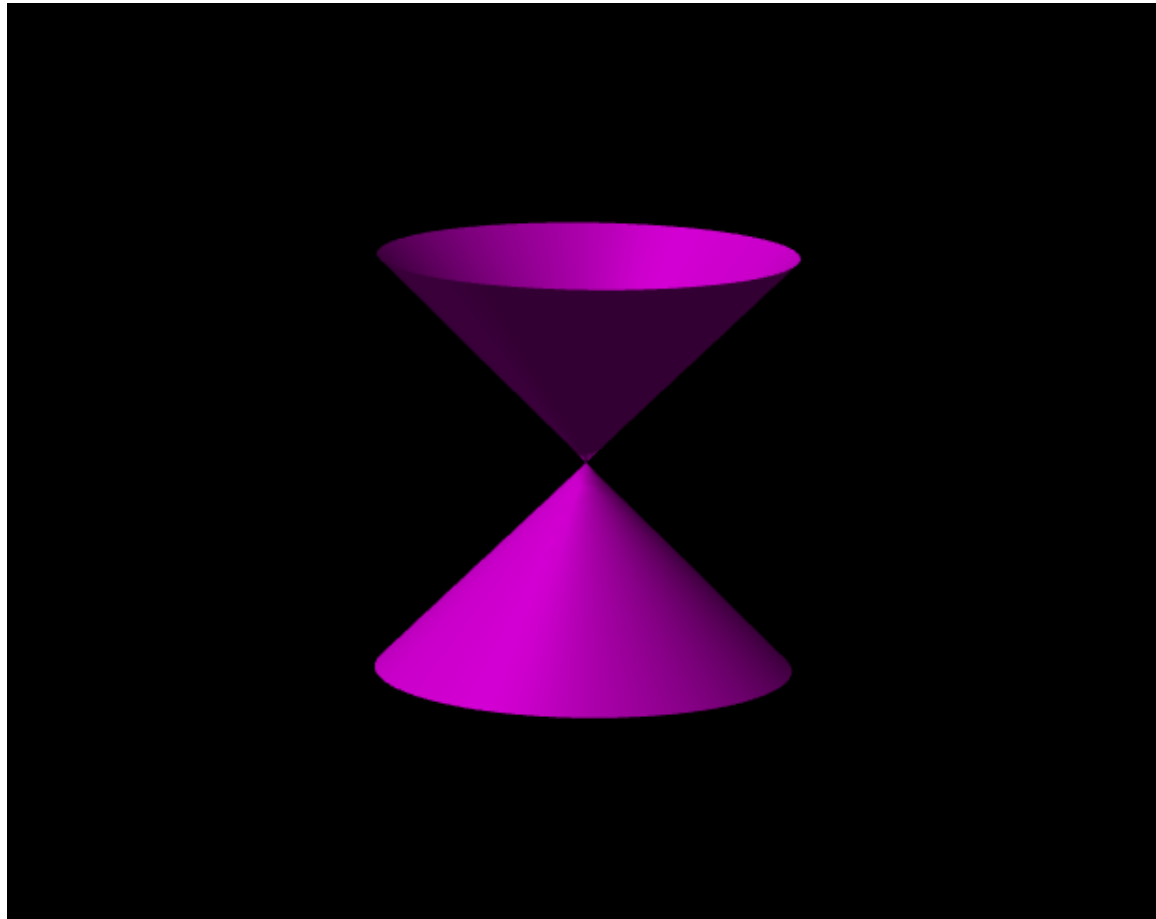

In high dimensions, the complex structure  $J$  of an ALE Kähler manifold is always standard at infinity.

This fails in real dimension 4.

Example: Eguchi-Hanson.

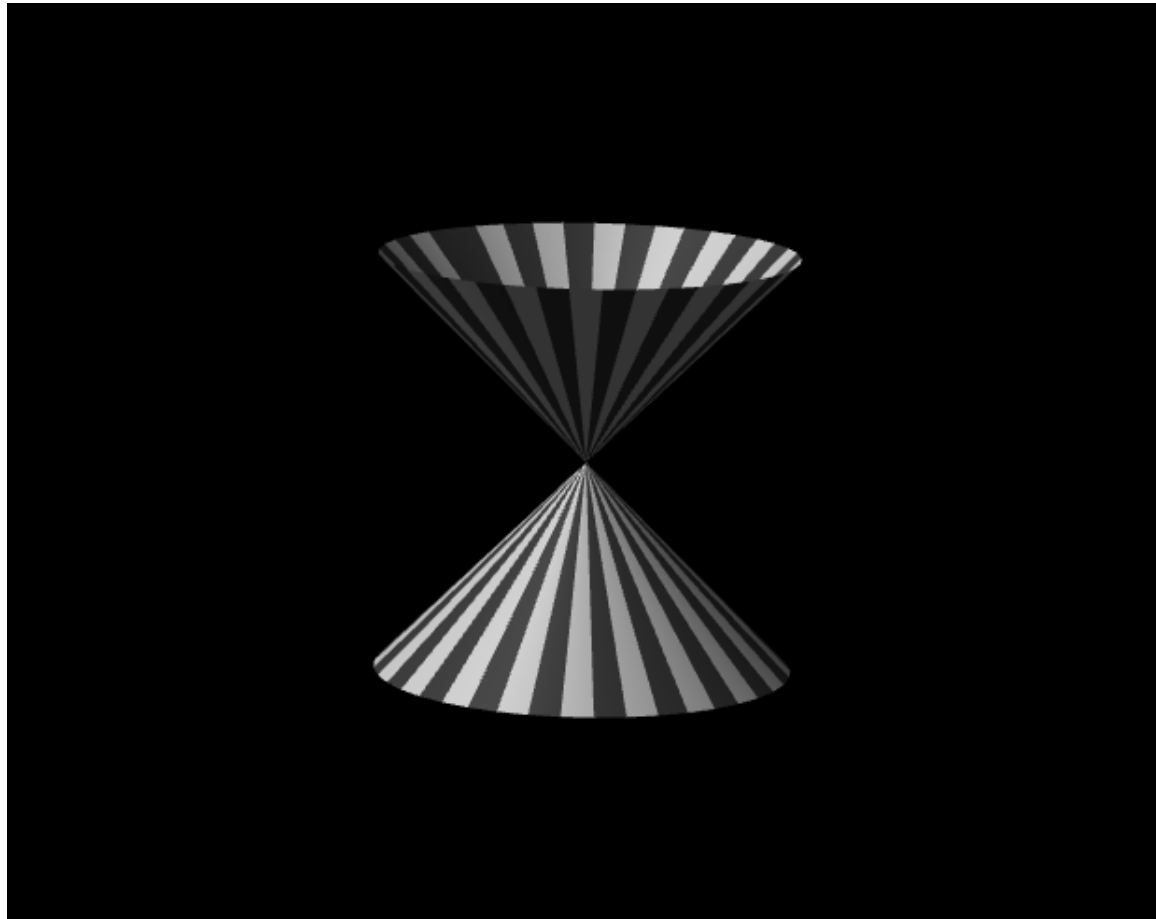

In high dimensions, the complex structure  $J$  of an ALE Kähler manifold is always standard at infinity.

This fails in real dimension 4.

Example: Eguchi-Hanson.

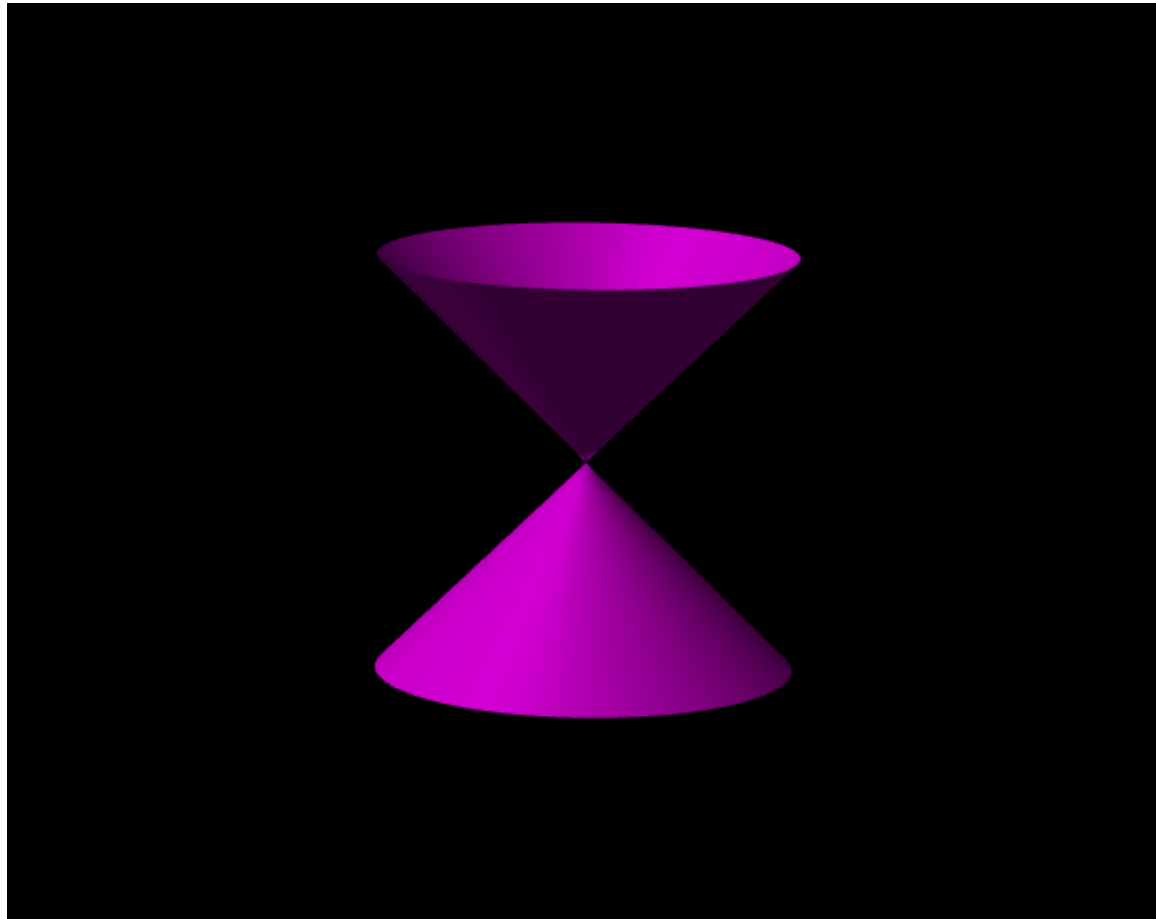

In high dimensions, the complex structure  $J$  of an ALE Kähler manifold is always standard at infinity.

This fails in real dimension 4.

Example: Eguchi-Hanson.

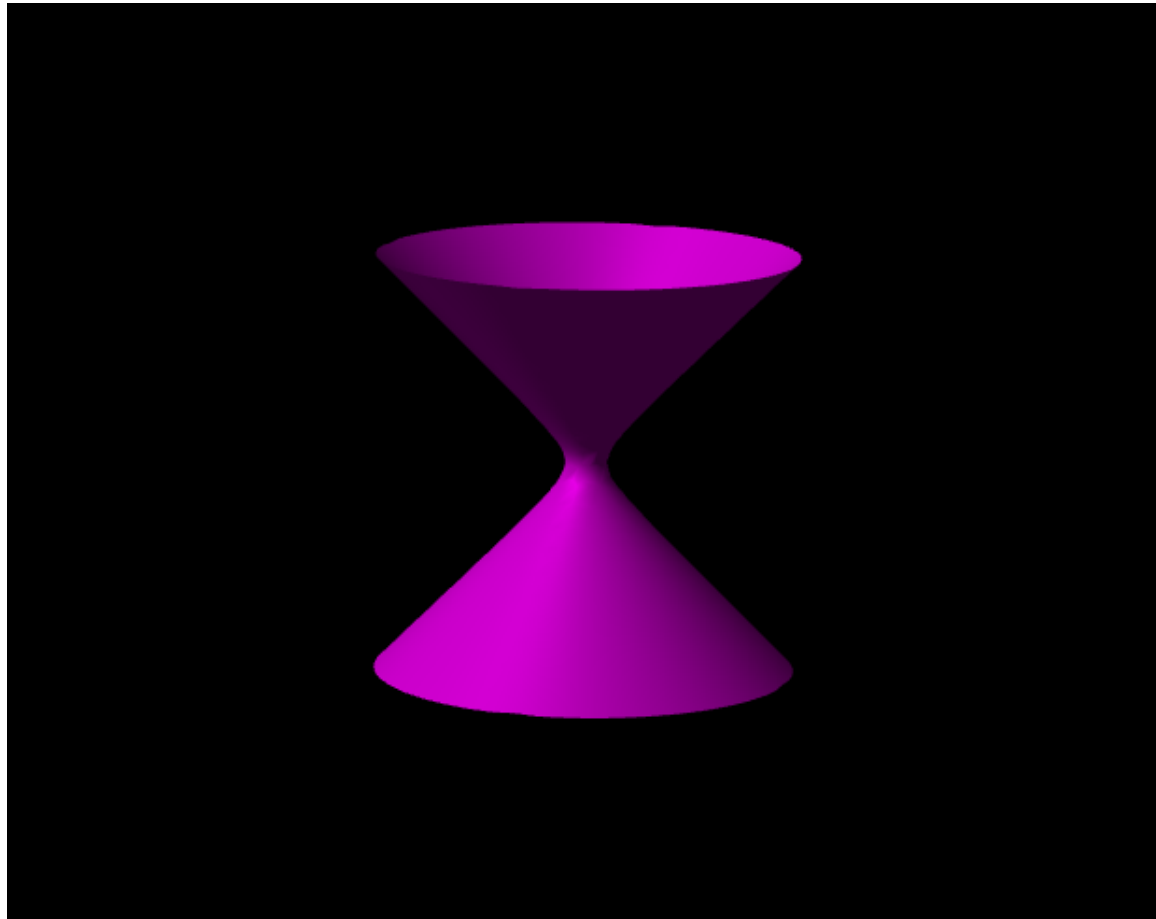

In high dimensions, the complex structure  $J$  of an ALE Kähler manifold is always standard at infinity.

This fails in real dimension 4.

**Example:** Eguchi-Hanson.

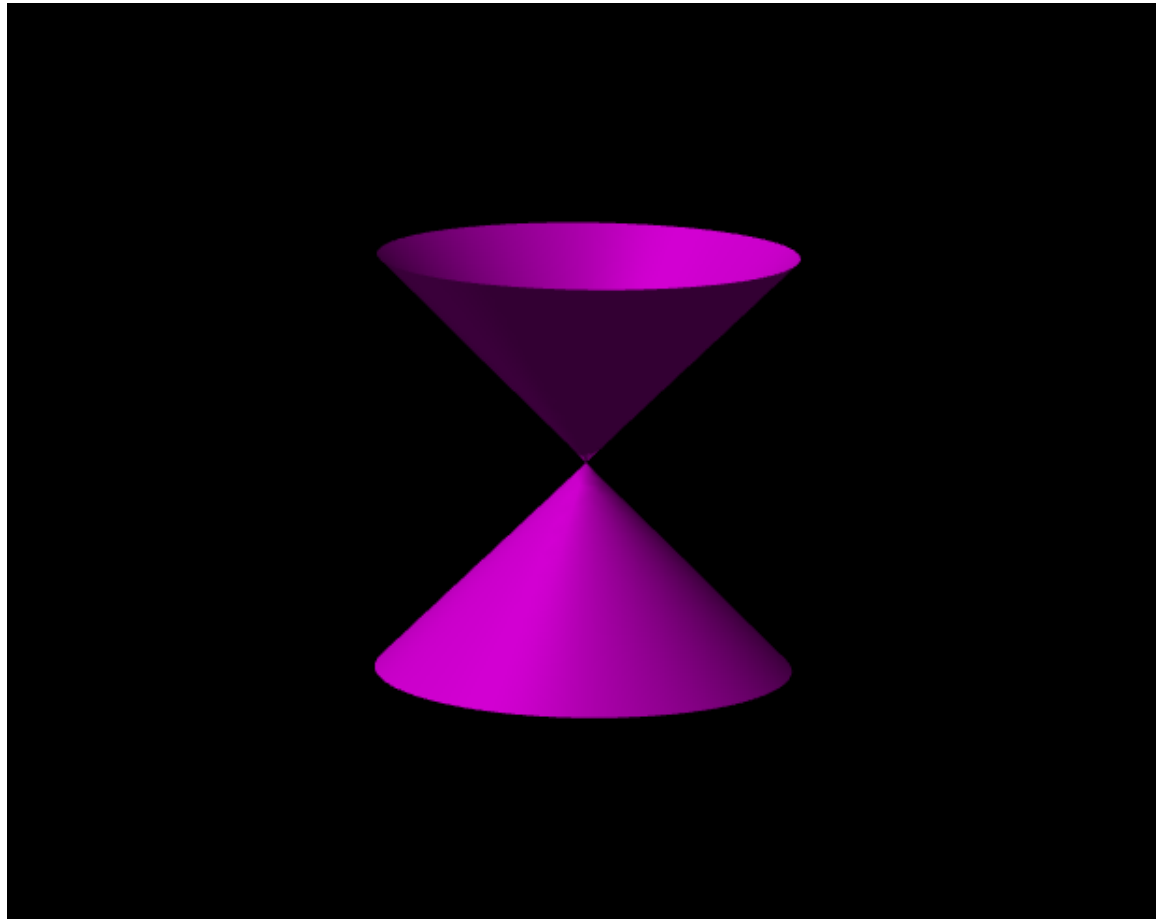

In high dimensions, the complex structure  $J$  of an ALE Kähler manifold is always standard at infinity.

This fails in real dimension 4.

Example: Eguchi-Hanson.

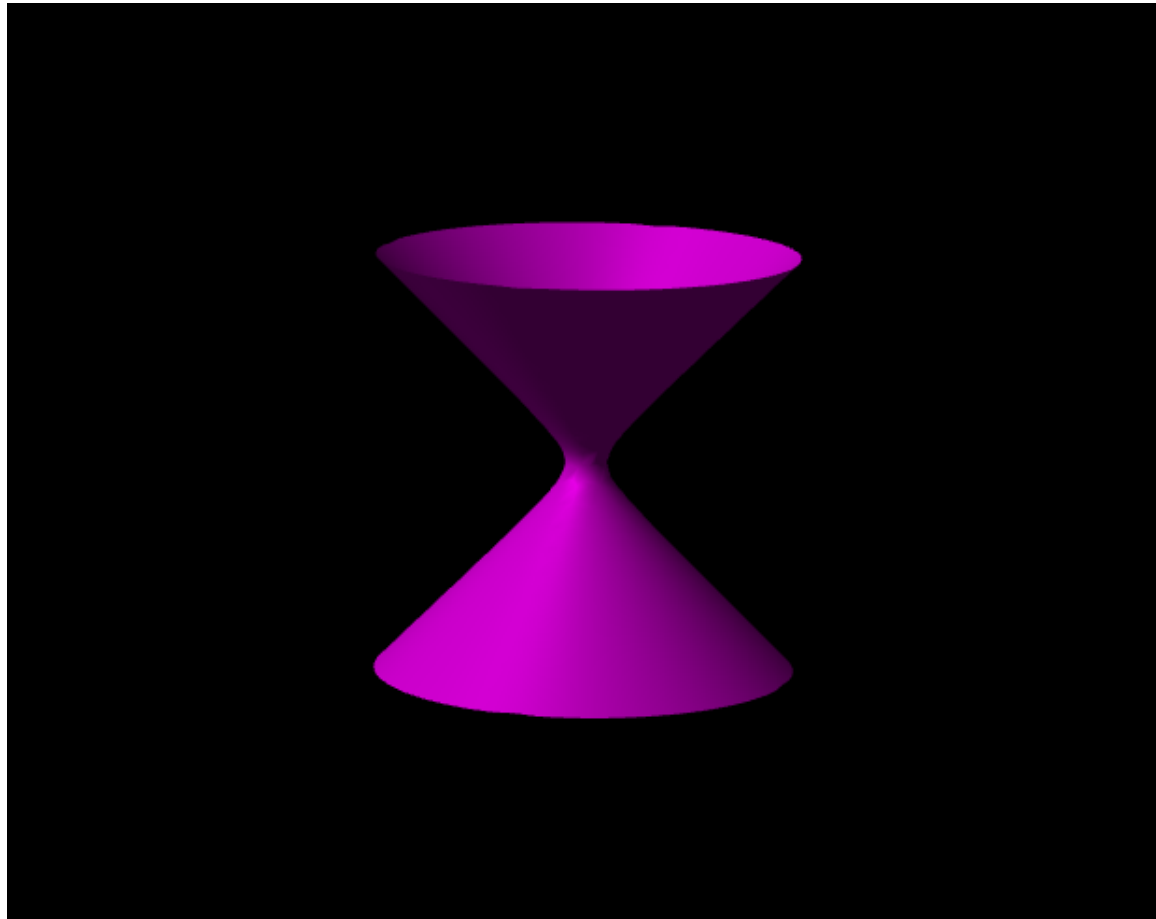

In high dimensions, the complex structure  $J$  of an ALE Kähler manifold is always standard at infinity.

This fails in real dimension 4.

Example: Eguchi-Hanson.

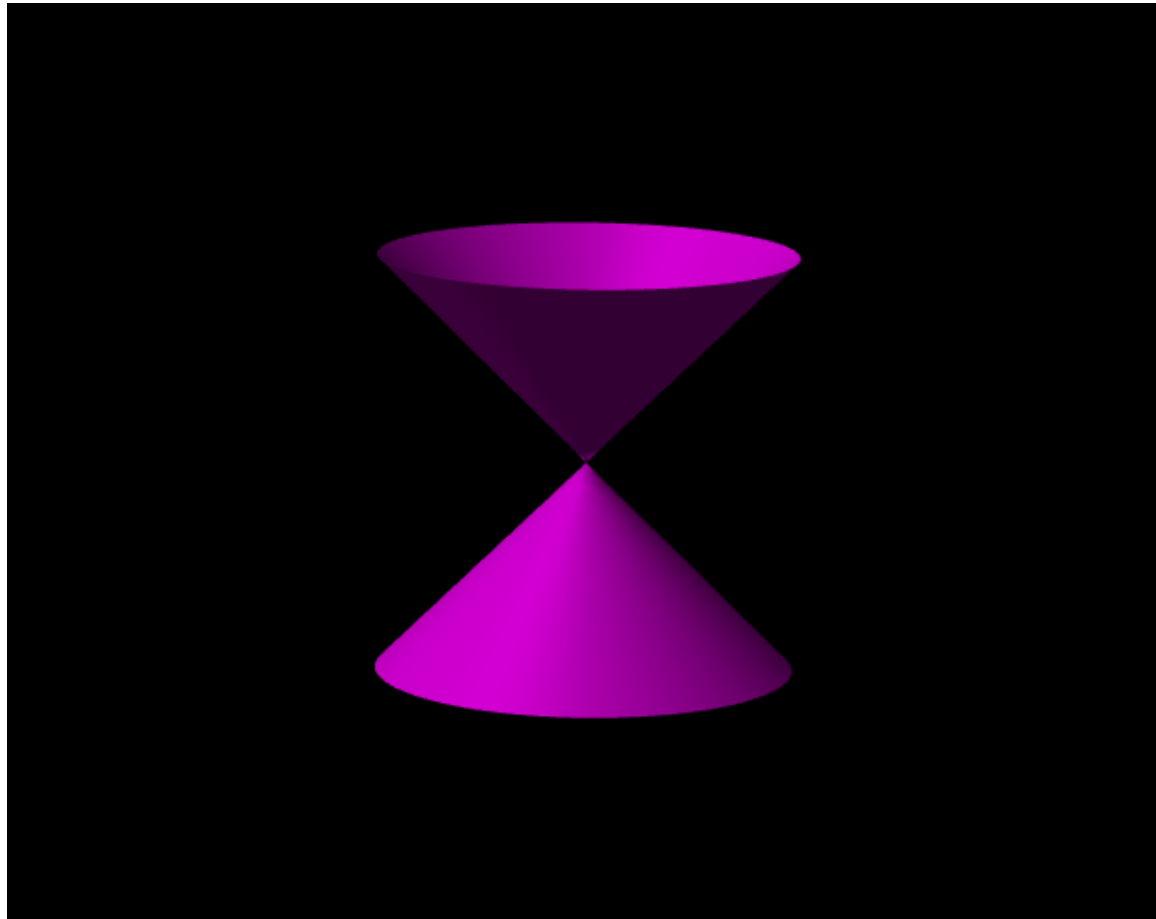



In high dimensions, the complex structure  $J$  of an ALE Kähler manifold is always standard at infinity.

This fails in real dimension 4.

Example: Eguchi-Hanson.

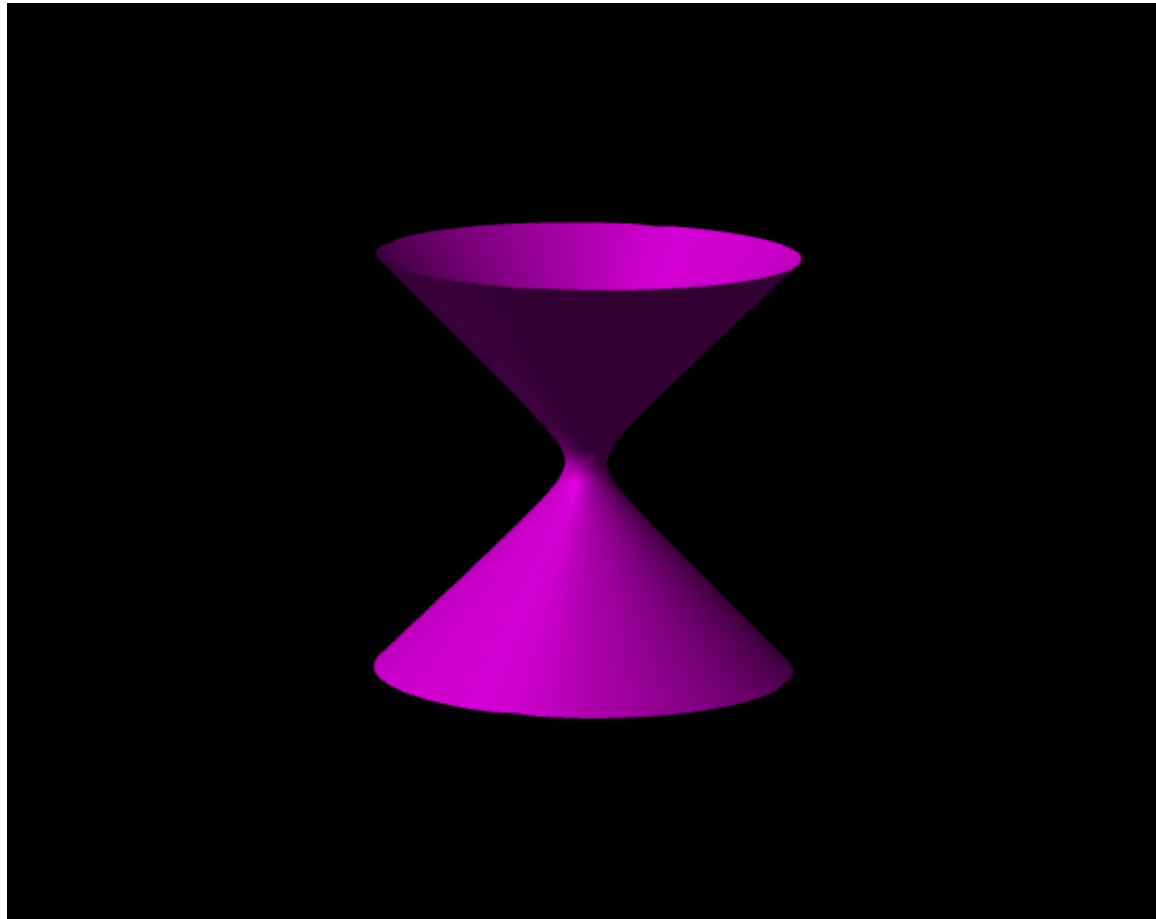

In high dimensions, the complex structure  $J$  of an ALE Kähler manifold is always standard at infinity.

This fails in real dimension 4.

This causes major technical complications.

In high dimensions, the complex structure  $J$  of an ALE Kähler manifold is always standard at infinity.

This fails in real dimension 4.

This causes major technical complications.

Fortunately, however, the symplectic structure is always standard at infinity!

**Proposition.**

**Proposition.** *Let  $(M^4, g, J)$  be an *ALE* Kähler surface,*

**Proposition.** *Let  $(M^4, g, J)$  be an *ALE* Kähler surface, let  $M_{\infty, i}$  be an end of  $M$ ,*

**Proposition.** *Let  $(M^4, g, J)$  be an **ALE** Kähler surface, let  $M_{\infty, i}$  be an end of  $M$ , let  $\widetilde{M}_{\infty, i}$  be the universal cover of  $M_{\infty, i}$ ,*

**Proposition.** *Let  $(M^4, g, J)$  be an **ALE** Kähler surface, let  $M_{\infty, i}$  be an end of  $M$ , let  $\widetilde{M}_{\infty, i}$  be the universal cover of  $M_{\infty, i}$ , and let*

$$(x^1, \dots, x^4) : \widetilde{M}_{\infty, i} \rightarrow \mathbb{R}^4 - B$$



**Proposition.** *Let  $(M^4, g, J)$  be an **ALE** Kähler surface, let  $M_{\infty, i}$  be an end of  $M$ , let  $\widetilde{M}_{\infty, i}$  be the universal cover of  $M_{\infty, i}$ , and let*

$$(x^1, \dots, x^4) : \widetilde{M}_{\infty, i} \rightarrow \mathbb{R}^4 - B$$

*be an asymptotic coordinate system in which the Kähler metric  $g$  is  $C^2$  and satisfies the Chruściel fall-off conditions.*

**Proposition.** *Let  $(M^4, g, J)$  be an **ALE** Kähler surface, let  $M_{\infty, i}$  be an end of  $M$ , let  $\widetilde{M}_{\infty, i}$  be the universal cover of  $M_{\infty, i}$ , and let*

$$(x^1, \dots, x^4) : \widetilde{M}_{\infty, i} \rightarrow \mathbb{R}^4 - B$$

*be an asymptotic coordinate system in which the Kähler metric  $g$  is  $C^2$  and satisfies the Chruściel fall-off conditions. Then there is  $\Gamma_i$ -equivariant  $C^2$ -diffeomorphism  $\Phi : \mathbb{R}^4 - C \rightarrow \mathbb{R}^4 - D$ ,*

**Proposition.** *Let  $(M^4, g, J)$  be an **ALE** Kähler surface, let  $M_{\infty, i}$  be an end of  $M$ , let  $\widetilde{M}_{\infty, i}$  be the universal cover of  $M_{\infty, i}$ , and let*

$$(x^1, \dots, x^4) : \widetilde{M}_{\infty, i} \rightarrow \mathbb{R}^4 - B$$

*be an asymptotic coordinate system in which the Kähler metric  $g$  is  $C^2$  and satisfies the Chruściel fall-off conditions. Then there is  $\Gamma_i$ -equivariant  $C^2$ -diffeomorphism  $\Phi : \mathbb{R}^4 - C \rightarrow \mathbb{R}^4 - D$ , where  $C \subset \mathbb{R}^4$  is a standard closed ball centered at the origin,*

**Proposition.** *Let  $(M^4, g, J)$  be an **ALE** Kähler surface, let  $M_{\infty, i}$  be an end of  $M$ , let  $\widetilde{M}_{\infty, i}$  be the universal cover of  $M_{\infty, i}$ , and let*

$$(x^1, \dots, x^4) : \widetilde{M}_{\infty, i} \rightarrow \mathbb{R}^4 - B$$

*be an asymptotic coordinate system in which the Kähler metric  $g$  is  $C^2$  and satisfies the Chruściel fall-off conditions. Then there is  $\Gamma_i$ -equivariant  $C^2$ -diffeomorphism  $\Phi : \mathbb{R}^4 - C \rightarrow \mathbb{R}^4 - D$ , where  $C \subset \mathbb{R}^4$  is a standard closed ball centered at the origin, such that*

**Proposition.** *Let  $(M^4, g, J)$  be an **ALE** Kähler surface, let  $M_{\infty, i}$  be an end of  $M$ , let  $\widetilde{M}_{\infty, i}$  be the universal cover of  $M_{\infty, i}$ , and let*

$$(x^1, \dots, x^4) : \widetilde{M}_{\infty, i} \rightarrow \mathbb{R}^4 - B$$

*be an asymptotic coordinate system in which the Kähler metric  $g$  is  $C^2$  and satisfies the Chruściel fall-off conditions. Then there is  $\Gamma_i$ -equivariant  $C^2$ -diffeomorphism  $\Phi : \mathbb{R}^4 - C \rightarrow \mathbb{R}^4 - D$ , where  $C \subset \mathbb{R}^4$  is a standard closed ball centered at the origin, such that*

$$\Phi^* \omega = \omega_0,$$

**Proposition.** *Let  $(M^4, g, J)$  be an **ALE** Kähler surface, let  $M_{\infty, i}$  be an end of  $M$ , let  $\widetilde{M}_{\infty, i}$  be the universal cover of  $M_{\infty, i}$ , and let*

$$(x^1, \dots, x^4) : \widetilde{M}_{\infty, i} \rightarrow \mathbb{R}^4 - B$$

*be an asymptotic coordinate system in which the Kähler metric  $g$  is  $C^2$  and satisfies the Chruściel fall-off conditions. Then there is  $\Gamma_i$ -equivariant  $C^2$ -diffeomorphism  $\Phi : \mathbb{R}^4 - C \rightarrow \mathbb{R}^4 - D$ , where  $C \subset \mathbb{R}^4$  is a standard closed ball centered at the origin, such that*

$$\begin{aligned} \Phi^* \omega &= \omega_0, \\ \omega_0 &= dx^1 \wedge dx^2 + dx^3 \wedge dx^4 \end{aligned}$$

**Proposition.** Let  $(M^4, g, J)$  be an *ALE* Kähler surface, let  $M_{\infty, i}$  be an end of  $M$ , let  $\widetilde{M}_{\infty, i}$  be the universal cover of  $M_{\infty, i}$ , and let

$$(x^1, \dots, x^4) : \widetilde{M}_{\infty, i} \rightarrow \mathbb{R}^4 - B$$

be an asymptotic coordinate system in which the Kähler metric  $g$  is  $C^2$  and satisfies the Chruściel fall-off conditions. Then there is  $\Gamma_i$ -equivariant  $C^2$ -diffeomorphism  $\Phi : \mathbb{R}^4 - C \rightarrow \mathbb{R}^4 - D$ , where  $C \subset \mathbb{R}^4$  is a standard closed ball centered at the origin, such that

$$\Phi^* \omega = \omega_0,$$

**Proposition.** *Let  $(M^4, g, J)$  be an **ALE** Kähler surface, let  $M_{\infty, i}$  be an end of  $M$ , let  $\widetilde{M}_{\infty, i}$  be the universal cover of  $M_{\infty, i}$ , and let*

$$(x^1, \dots, x^4) : \widetilde{M}_{\infty, i} \rightarrow \mathbb{R}^4 - B$$

*be an asymptotic coordinate system in which the Kähler metric  $g$  is  $C^2$  and satisfies the Chruściel fall-off conditions. Then there is  $\Gamma_i$ -equivariant  $C^2$ -diffeomorphism  $\Phi : \mathbb{R}^4 - C \rightarrow \mathbb{R}^4 - D$ , where  $C \subset \mathbb{R}^4$  is a standard closed ball centered at the origin, such that*

$$\Phi^* \omega = \omega_0,$$

*with  $|\Phi(x) - x| = O(|x|^{-\varepsilon})$  and  $|\Phi_* - I| = (|x|^{-1-\varepsilon})$ .*



**Proposition.** *Let  $(M^4, g, J)$  be an ALE Kähler surface, let  $M_{\infty, i}$  be an end of  $M$ , let  $\widetilde{M}_{\infty, i}$  be the universal cover of  $M_{\infty, i}$ , and let*

$$(x^1, \dots, x^4) : \widetilde{M}_{\infty, i} \rightarrow \mathbb{R}^4 - B$$

*be an asymptotic coordinate system in which the Kähler metric  $g$  is  $C^2$  and satisfies the Chruściel fall-off conditions. Then there is  $\Gamma_i$ -equivariant  $C^2$ -diffeomorphism  $\Phi : \mathbb{R}^4 - C \rightarrow \mathbb{R}^4 - D$ , where  $C \subset \mathbb{R}^4$  is a standard closed ball centered at the origin, such that*

$$\Phi^* \omega = \omega_0,$$

*with  $|\Phi(x) - x| = O(|x|^{-\varepsilon})$  and  $|\Phi_* - I| = (|x|^{-1-\varepsilon})$ .*

Quantitative version of Moser stability argument...

Symplectically compactify any **ALE** Kähler surface:

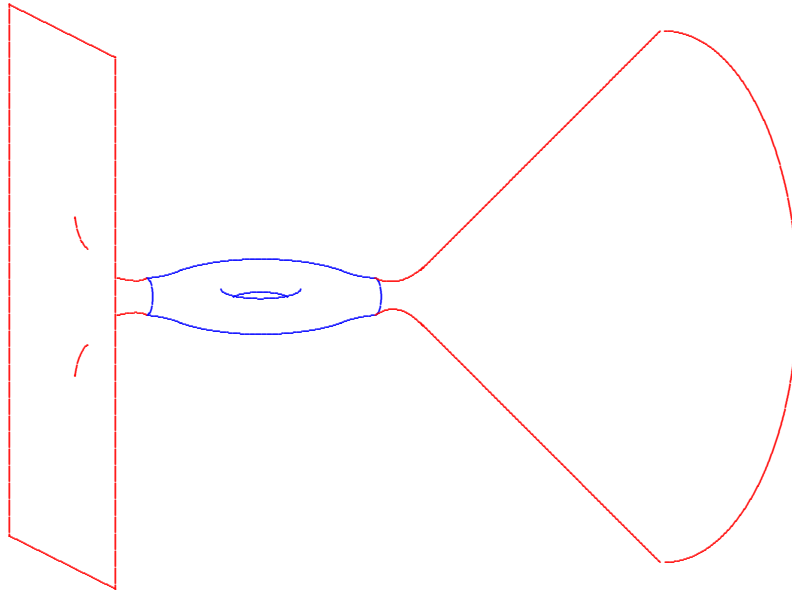

Symplectically compactify any **ALE** Kähler surface:

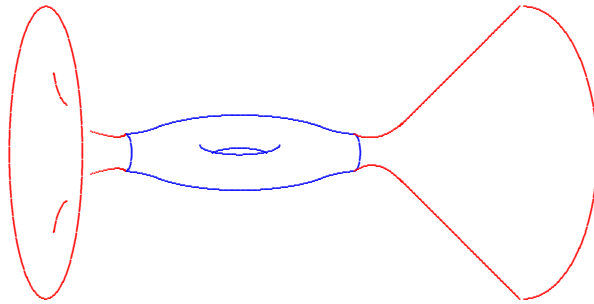

- Truncate at large radius;

Symplectically compactify any **ALE** Kähler surface:

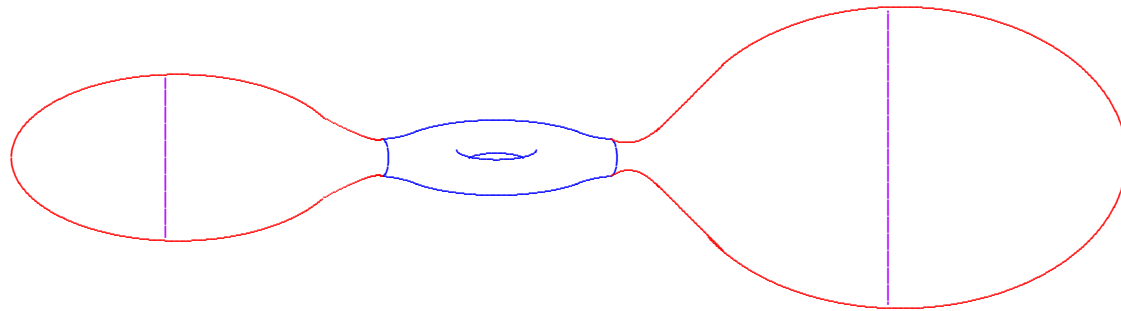

- Truncate at large radius;
- Glue in standard plugs.

Plug?

Plug?

For an **AE** end, plug is just  $\mathbb{C}P_2$  minus a ball.

Plug?

For an **AE** end, plug is just  $\mathbb{C}P_2$  minus a ball.

More generally, use partial resolution of  $\mathbb{C}P_2/\Gamma_i$ .

Plug?

For an **AE** end, plug is just  $\mathbb{C}P_2$  minus a ball.

More generally, use partial resolution of  $\mathbb{C}P_2/\Gamma_i$ .

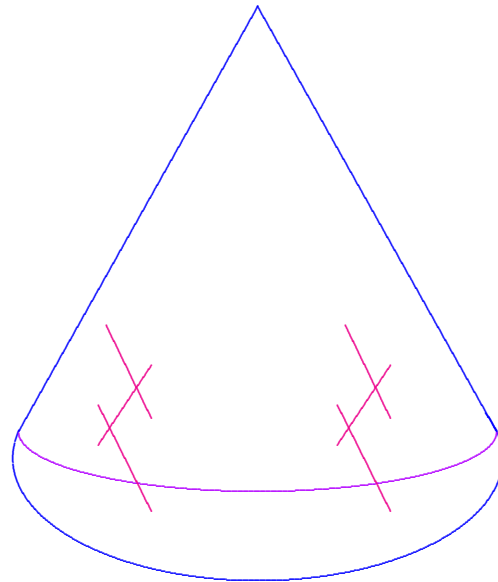



Plug?

For an **AE** end, plug is just  $\mathbb{C}P_2$  minus a ball.

More generally, use partial resolution of  $\mathbb{C}P_2/\Gamma_i$ .

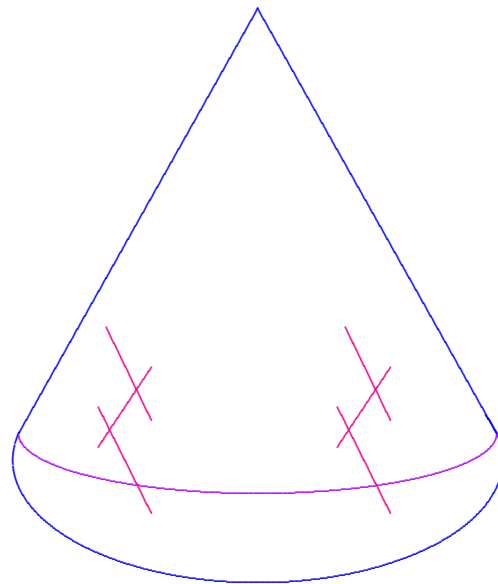

“ $\Gamma_i$ -Capsule”

Plug?

For an **AE** end, plug is just  $\mathbb{C}P_2$  minus a ball.

More generally, use partial resolution of  $\mathbb{C}P_2/\Gamma_i$ .



“ $\Gamma_i$ -Capsule”

Plug?

For an **AE** end, plug is just  $\mathbb{C}P_2$  minus a ball.

More generally, use partial resolution of  $\mathbb{C}P_2/\Gamma_i$ .

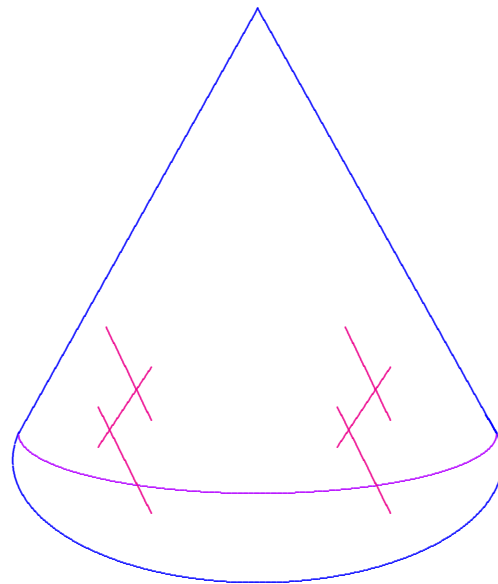

“ $\Gamma_i$ -Capsule”

**Proposition.** *Let  $\Gamma \subset \mathbf{U}(2)$  be a finite subgroup*

**Proposition.** *Let  $\Gamma \subset \mathbf{U}(2)$  be a finite subgroup  $\neq \{1\}$*

**Proposition.** *Let  $\Gamma \subset \mathbf{U}(2)$  be a finite subgroup  $\neq \{1\}$  that acts freely on the unit sphere  $S^3 \subset \mathbb{C}^2$ .*

**Proposition.** *Let  $\Gamma \subset \mathbf{U}(2)$  be a finite subgroup  $\neq \{1\}$  that acts freely on the unit sphere  $S^3 \subset \mathbb{C}^2$ . Then  $\exists$  4-dimensional compact connected symplectic orbifold  $(X_\Gamma, \omega_\Gamma)$*

**Proposition.** *Let  $\Gamma \subset \mathbf{U}(2)$  be a finite subgroup  $\neq \{1\}$  that acts freely on the unit sphere  $S^3 \subset \mathbb{C}^2$ . Then  $\exists$  4-dimensional compact connected symplectic orbifold  $(X_\Gamma, \omega_\Gamma)$  such that*



**Proposition.** *Let  $\Gamma \subset \mathbf{U}(2)$  be a finite subgroup  $\neq \{1\}$  that acts freely on the unit sphere  $S^3 \subset \mathbb{C}^2$ . Then  $\exists$  4-dimensional compact connected symplectic orbifold  $(X_\Gamma, \omega_\Gamma)$  such that*

- $(X_\Gamma, \omega_\Gamma)$  contains unique singular point  $p$ ;

**Proposition.** *Let  $\Gamma \subset \mathbf{U}(2)$  be a finite subgroup  $\neq \{1\}$  that acts freely on the unit sphere  $S^3 \subset \mathbb{C}^2$ . Then  $\exists$  4-dimensional compact connected symplectic orbifold  $(X_\Gamma, \omega_\Gamma)$  such that*

- $(X_\Gamma, \omega_\Gamma)$  contains unique singular point  $p$ ;
- $p$  has nbhd symplectomorphic to  $(\mathcal{B}, \omega_0)/\Gamma$

**Proposition.** *Let  $\Gamma \subset \mathbf{U}(2)$  be a finite subgroup  $\neq \{1\}$  that acts freely on the unit sphere  $S^3 \subset \mathbb{C}^2$ . Then  $\exists$  4-dimensional compact connected symplectic orbifold  $(X_\Gamma, \omega_\Gamma)$  such that*

- $(X_\Gamma, \omega_\Gamma)$  contains unique singular point  $p$ ;
- $p$  has nbhd symplectomorphic to  $(\mathcal{B}, \omega_0)/\Gamma$  for some standard ball  $\mathcal{B} \subset \mathbb{C}^2$

**Proposition.** *Let  $\Gamma \subset \mathbf{U}(2)$  be a finite subgroup  $\neq \{1\}$  that acts freely on the unit sphere  $S^3 \subset \mathbb{C}^2$ . Then  $\exists$  4-dimensional compact connected symplectic orbifold  $(X_\Gamma, \omega_\Gamma)$  such that*

- $(X_\Gamma, \omega_\Gamma)$  contains unique singular point  $p$ ;
- $p$  has nbhd symplectomorphic to  $(\mathcal{B}, \omega_0)/\Gamma$  for some standard ball  $\mathcal{B} \subset \mathbb{C}^2$  and standard action of  $\Gamma \subset \mathbf{U}(2)$  ;

**Proposition.** *Let  $\Gamma \subset \mathbf{U}(2)$  be a finite subgroup  $\neq \{1\}$  that acts freely on the unit sphere  $S^3 \subset \mathbb{C}^2$ . Then  $\exists$  4-dimensional compact connected symplectic orbifold  $(X_\Gamma, \omega_\Gamma)$  such that*

- $(X_\Gamma, \omega_\Gamma)$  contains unique singular point  $p$ ;
- $p$  has nbhd symplectomorphic to  $(\mathcal{B}, \omega_0)/\Gamma$  for some standard ball  $\mathcal{B} \subset \mathbb{C}^2$  and standard action of  $\Gamma \subset \mathbf{U}(2)$  ; and

**Proposition.** *Let  $\Gamma \subset \mathbf{U}(2)$  be a finite subgroup  $\neq \{1\}$  that acts freely on the unit sphere  $S^3 \subset \mathbb{C}^2$ . Then  $\exists$  4-dimensional compact connected symplectic orbifold  $(X_\Gamma, \omega_\Gamma)$  such that*

- $(X_\Gamma, \omega_\Gamma)$  contains unique singular point  $p$ ;
- $p$  has nbhd symplectomorphic to  $(\mathcal{B}, \omega_0)/\Gamma$  for some standard ball  $\mathcal{B} \subset \mathbb{C}^2$  and standard action of  $\Gamma \subset \mathbf{U}(2)$  ; and
- $\exists$  symplectic immersion  $j : S^2 \looparrowright X_\Gamma - \{p\}$ ,

**Proposition.** *Let  $\Gamma \subset \mathbf{U}(2)$  be a finite subgroup  $\neq \{1\}$  that acts freely on the unit sphere  $S^3 \subset \mathbb{C}^2$ . Then  $\exists$  4-dimensional compact connected symplectic orbifold  $(X_\Gamma, \omega_\Gamma)$  such that*

- $(X_\Gamma, \omega_\Gamma)$  contains unique singular point  $p$ ;
- $p$  has nbhd symplectomorphic to  $(\mathcal{B}, \omega_0)/\Gamma$  for some standard ball  $\mathcal{B} \subset \mathbb{C}^2$  and standard action of  $\Gamma \subset \mathbf{U}(2)$  ; and
- $\exists$  symplectic immersion  $j : S^2 \looparrowright X_\Gamma - \{p\}$ , with at worst transverse positively-oriented double points,

**Proposition.** *Let  $\Gamma \subset \mathbf{U}(2)$  be a finite subgroup  $\neq \{1\}$  that acts freely on the unit sphere  $S^3 \subset \mathbb{C}^2$ . Then  $\exists$  4-dimensional compact connected symplectic orbifold  $(X_\Gamma, \omega_\Gamma)$  such that*

- $(X_\Gamma, \omega_\Gamma)$  contains unique singular point  $p$ ;
- $p$  has nbhd symplectomorphic to  $(\mathcal{B}, \omega_0)/\Gamma$  for some standard ball  $\mathcal{B} \subset \mathbb{C}^2$  and standard action of  $\Gamma \subset \mathbf{U}(2)$  ; and
- $\exists$  symplectic immersion  $j : S^2 \looparrowright X_\Gamma - \{p\}$ , with at worst transverse positively-oriented double points, such that

$$\int_{S^2} j^*[c_1(X_\Gamma - \{p\}, J)] \geq 3$$



**Proposition.** *Let  $\Gamma \subset \mathbf{U}(2)$  be a finite subgroup  $\neq \{1\}$  that acts freely on the unit sphere  $S^3 \subset \mathbb{C}^2$ . Then  $\exists$  4-dimensional compact connected symplectic orbifold  $(X_\Gamma, \omega_\Gamma)$  such that*

- $(X_\Gamma, \omega_\Gamma)$  contains unique singular point  $p$ ;
- $p$  has nbhd symplectomorphic to  $(\mathcal{B}, \omega_0)/\Gamma$  for some standard ball  $\mathcal{B} \subset \mathbb{C}^2$  and standard action of  $\Gamma \subset \mathbf{U}(2)$  ; and
- $\exists$  symplectic immersion  $j : S^2 \looparrowright X_\Gamma - \{p\}$ , with at worst transverse positively-oriented double points, such that

$$\int_{S^2} j^*[c_1(X_\Gamma - \{p\}, J)] \geq 3$$

for some, and hence any,  $\omega$ -compatible almost-complex structure  $J$ .

**Definition.** Let  $\Gamma \subset \mathbf{U}(2)$  be any finite subgroup that acts freely on the unit sphere  $S^3 \subset \mathbb{C}^2$ .

**Definition.** Let  $\Gamma \subset \mathbf{U}(2)$  be any finite subgroup that acts freely on the unit sphere  $S^3 \subset \mathbb{C}^2$ . Then

- If  $\Gamma \neq \{1\}$ , a  $\Gamma$ -capsule will mean this symplectic orbifold  $(X_\Gamma, \omega_\Gamma)$ .

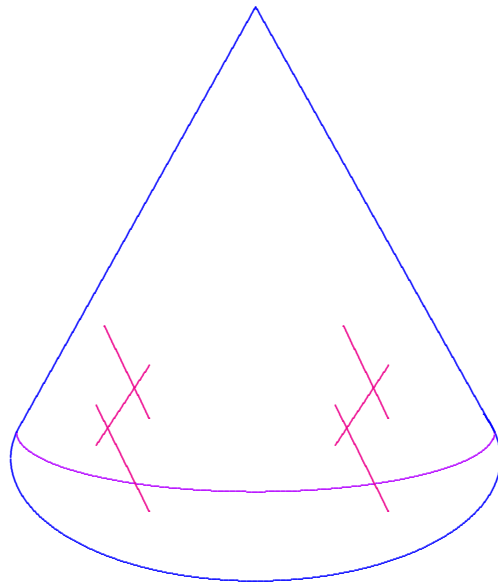

**Definition.** Let  $\Gamma \subset \mathbf{U}(2)$  be any finite subgroup that acts freely on the unit sphere  $S^3 \subset \mathbb{C}^2$ . Then

- If  $\Gamma \neq \{1\}$ , a  $\Gamma$ -capsule will mean this symplectic orbifold  $(X_\Gamma, \omega_\Gamma)$ .

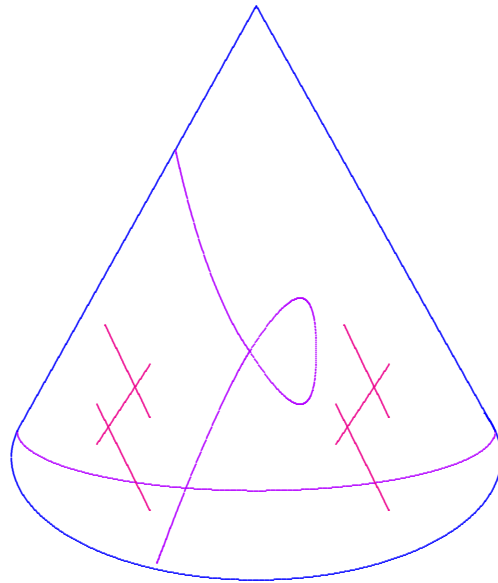

**Definition.** Let  $\Gamma \subset \mathbf{U}(2)$  be any finite subgroup that acts freely on the unit sphere  $S^3 \subset \mathbb{C}^2$ . Then

- If  $\Gamma \neq \{1\}$ , a  $\Gamma$ -capsule will mean this symplectic orbifold  $(X_\Gamma, \omega_\Gamma)$ . The singular point  $p$  will be called the base-point of  $X_\Gamma$ .

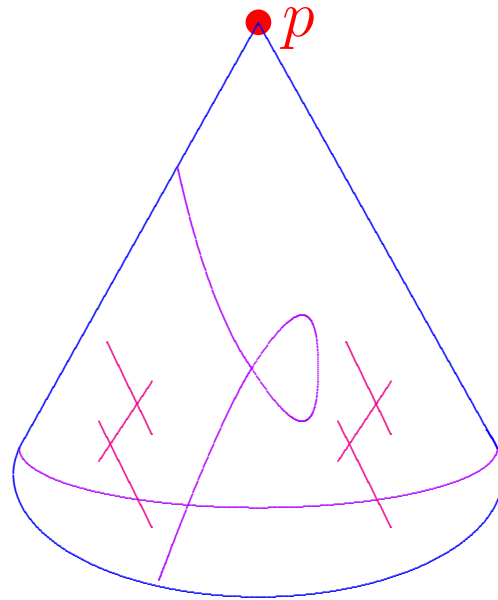

**Definition.** Let  $\Gamma \subset \mathbf{U}(2)$  be any finite subgroup that acts freely on the unit sphere  $S^3 \subset \mathbb{C}^2$ . Then

- If  $\Gamma \neq \{1\}$ , a  $\Gamma$ -capsule will mean this symplectic orbifold  $(X_\Gamma, \omega_\Gamma)$ . The singular point  $p$  will be called the base-point of  $X_\Gamma$ .
- If  $\Gamma = \{1\}$ , we instead define the  $\Gamma$ -capsule  $(X_\Gamma, \omega_\Gamma)$  to be  $\mathbb{C}P_2$ ,

**Definition.** Let  $\Gamma \subset \mathbf{U}(2)$  be any finite subgroup that acts freely on the unit sphere  $S^3 \subset \mathbb{C}^2$ . Then

- If  $\Gamma \neq \{1\}$ , a  $\Gamma$ -capsule will mean this symplectic orbifold  $(X_\Gamma, \omega_\Gamma)$ . The singular point  $p$  will be called the base-point of  $X_\Gamma$ .
- If  $\Gamma = \{1\}$ , we instead define the  $\Gamma$ -capsule  $(X_\Gamma, \omega_\Gamma)$  to be  $\mathbb{C}P_2$ , equipped with its standard Fubini-Study symplectic structure.

**Definition.** Let  $\Gamma \subset \mathbf{U}(2)$  be any finite subgroup that acts freely on the unit sphere  $S^3 \subset \mathbb{C}^2$ . Then

- If  $\Gamma \neq \{1\}$ , a  $\Gamma$ -capsule will mean this symplectic orbifold  $(X_\Gamma, \omega_\Gamma)$ . The singular point  $p$  will be called the base-point of  $X_\Gamma$ .
- If  $\Gamma = \{1\}$ , we instead define the  $\Gamma$ -capsule  $(X_\Gamma, \omega_\Gamma)$  to be  $\mathbb{C}\mathbb{P}_2$ , equipped with its standard Fubini-Study symplectic structure. In this case, the base-point  $p$  of  $X_\Gamma$  will simply mean  $[0 : 0 : 1] \in \mathbb{C}\mathbb{P}_2$ .



Key tools:

Key tools:

**Theorem** (McDuff 1990).

Key tools:

**Theorem** (McDuff 1990). *Let  $(V^4, \omega)$  be a compact symplectic 4-manifold*

Key tools:

**Theorem** (McDuff 1990). *Let  $(V^4, \omega)$  be a compact symplectic 4-manifold which contains a symplectically embedded 2-sphere  $\mathcal{S} \subset V$*

Key tools:

**Theorem** (McDuff 1990). *Let  $(V^4, \omega)$  be a compact symplectic 4-manifold which contains a symplectically *embedded* 2-sphere  $\mathcal{S} \subset V$  with positive normal bundle.*

Key tools:

**Theorem** (McDuff 1990). *Let  $(V^4, \omega)$  be a compact symplectic 4-manifold which contains a symplectically *embedded* 2-sphere  $\mathcal{S} \subset V$  with positive normal bundle. Then  $(V, \omega)$  is symplectomorphic to a blow-up of  $\mathbb{C}P_2$  or  $S^2 \times S^2$ .*

Key tools:

**Theorem** (McDuff 1990). *Let  $(V^4, \omega)$  be a compact symplectic 4-manifold which contains a symplectically *embedded* 2-sphere  $\mathcal{S} \subset V$  with positive normal bundle. Then  $(V, \omega)$  is symplectomorphic to a blow-up of  $\mathbb{C}P_2$  or  $S^2 \times S^2$ .*

Positive normal bundle  $\iff \int_{\mathcal{S}} c_1 \geq 3$ .

Key tools:

**Theorem** (McDuff 1990). *Let  $(V^4, \omega)$  be a compact symplectic 4-manifold which contains a symplectically embedded 2-sphere  $\mathcal{S} \subset V$  with positive normal bundle. Then  $(V, \omega)$  is symplectomorphic to a blow-up of  $\mathbb{C}P_2$  or  $S^2 \times S^2$ .*

Positive normal bundle  $\iff \int_{\mathcal{S}} c_1 \geq 3$ .

Prototype: “Rational complex surfaces.”



Key tools:

**Theorem** (McDuff 1990). *Let  $(V^4, \omega)$  be a compact symplectic 4-manifold which contains a symplectically embedded 2-sphere  $\mathcal{S} \subset V$  with positive normal bundle. Then  $(V, \omega)$  is symplectomorphic to a blow-up of  $\mathbb{C}P_2$  or  $S^2 \times S^2$ .*

Positive normal bundle  $\iff \int_{\mathcal{S}} c_1 \geq 3$ .

Prototype: “Rational complex surfaces.”

Proof uses  $J$ -holomorphic curves.

Key tools:

**Theorem** (McDuff 1990). *Let  $(V^4, \omega)$  be a compact symplectic 4-manifold which contains a symplectically *embedded* 2-sphere  $\mathcal{S} \subset V$  with positive normal bundle. Then  $(V, \omega)$  is symplectomorphic to a blow-up of  $\mathbb{C}P_2$  or  $S^2 \times S^2$ .*

Key tools:

**Theorem** (McDuff 1990). *Let  $(V^4, \omega)$  be a compact symplectic 4-manifold which contains a symplectically *embedded* 2-sphere  $\mathcal{S} \subset V$  with positive normal bundle. Then  $(V, \omega)$  is symplectomorphic to a blow-up of  $\mathbb{C}P_2$  or  $S^2 \times S^2$ .*

**Theorem** (McDuff 1992).

Key tools:

**Theorem** (McDuff 1990). *Let  $(V^4, \omega)$  be a compact symplectic 4-manifold which contains a symplectically *embedded* 2-sphere  $\mathcal{S} \subset V$  with positive normal bundle. Then  $(V, \omega)$  is symplectomorphic to a blow-up of  $\mathbb{C}P_2$  or  $S^2 \times S^2$ .*

**Theorem** (McDuff 1992). *Let  $(V^4, \omega)$  be a compact symplectic 4-manifold*

Key tools:

**Theorem** (McDuff 1990). *Let  $(V^4, \omega)$  be a compact symplectic 4-manifold which contains a symplectically *embedded* 2-sphere  $\mathcal{S} \subset V$  with positive normal bundle. Then  $(V, \omega)$  is symplectomorphic to a blow-up of  $\mathbb{C}P_2$  or  $S^2 \times S^2$ .*

**Theorem** (McDuff 1992). *Let  $(V^4, \omega)$  be a compact symplectic 4-manifold which contains a symplectically *immersed* 2-sphere  $\mathcal{S} \looparrowright V$*

Key tools:

**Theorem** (McDuff 1990). *Let  $(V^4, \omega)$  be a compact symplectic 4-manifold which contains a symplectically *embedded* 2-sphere  $\mathcal{S} \subset V$  with positive normal bundle. Then  $(V, \omega)$  is symplectomorphic to a blow-up of  $\mathbb{C}P_2$  or  $S^2 \times S^2$ .*

**Theorem** (McDuff 1992). *Let  $(V^4, \omega)$  be a compact symplectic 4-manifold which contains a symplectically *immersed* 2-sphere  $\mathcal{S} \looparrowright V$  with at worst positively-oriented double points*

Key tools:

**Theorem** (McDuff 1990). *Let  $(V^4, \omega)$  be a compact symplectic 4-manifold which contains a symplectically *embedded* 2-sphere  $\mathcal{S} \subset V$  with positive normal bundle. Then  $(V, \omega)$  is symplectomorphic to a blow-up of  $\mathbb{C}P_2$  or  $S^2 \times S^2$ .*

**Theorem** (McDuff 1992). *Let  $(V^4, \omega)$  be a compact symplectic 4-manifold which contains a symplectically *immersed* 2-sphere  $\mathcal{S} \looparrowright V$  with at worst positively-oriented double points and with  $\int_{\mathcal{S}} c_1 \geq 3$ .*

Key tools:

**Theorem** (McDuff 1990). *Let  $(V^4, \omega)$  be a compact symplectic 4-manifold which contains a symplectically *embedded* 2-sphere  $\mathcal{S} \subset V$  with positive normal bundle. Then  $(V, \omega)$  is symplectomorphic to a blow-up of  $\mathbb{C}P_2$  or  $S^2 \times S^2$ .*

**Theorem** (McDuff 1992). *Let  $(V^4, \omega)$  be a compact symplectic 4-manifold which contains a symplectically *immersed* 2-sphere  $\mathcal{S} \looparrowright V$  with at worst positively-oriented double points and with  $\int_{\mathcal{S}} c_1 \geq 3$ . Then  $(V, \omega)$  is symplectomorphic to a blow-up of  $\mathbb{C}P_2$  or  $S^2 \times S^2$ .*



**Lemma.** *Any ALE Kähler manifold has only one end.*

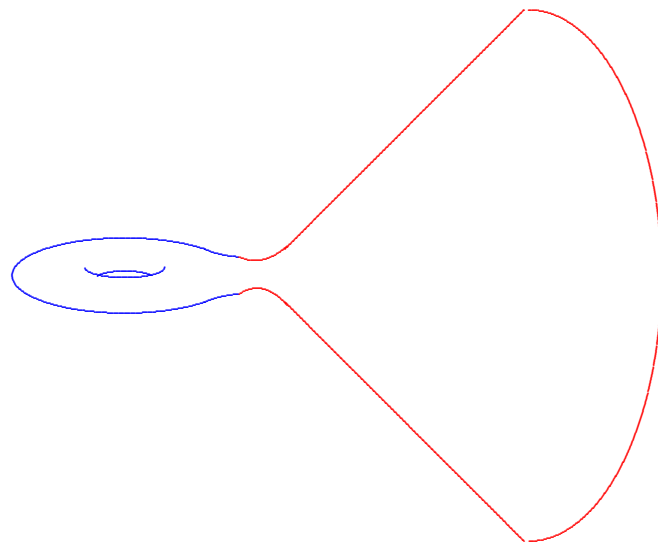

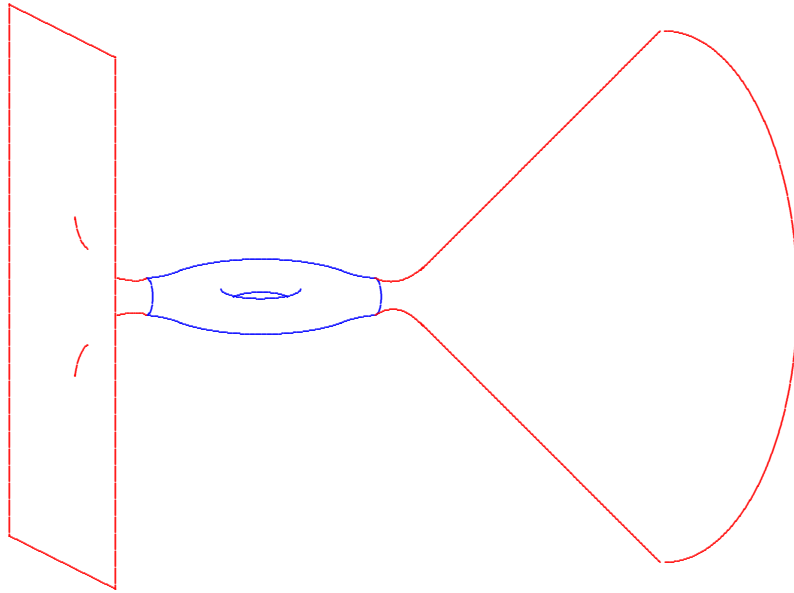

What if  $M^4$  has more than one end?

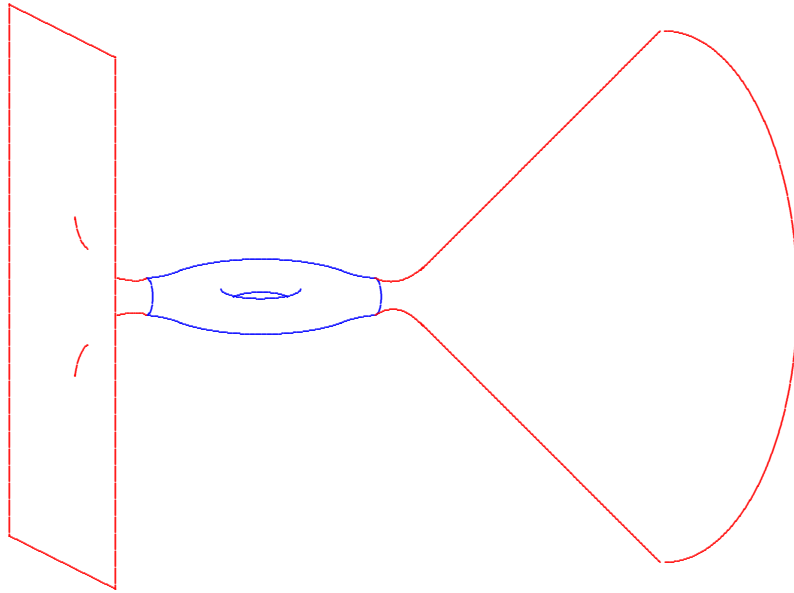

Compactify  $M$  as symplectic 4-manifold  $\widehat{M}$ .

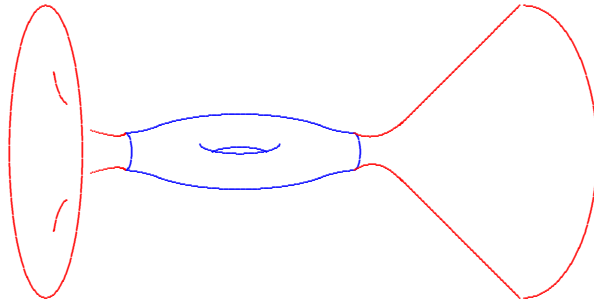

Compactify  $M$  as symplectic 4-manifold  $\widehat{M}$ .

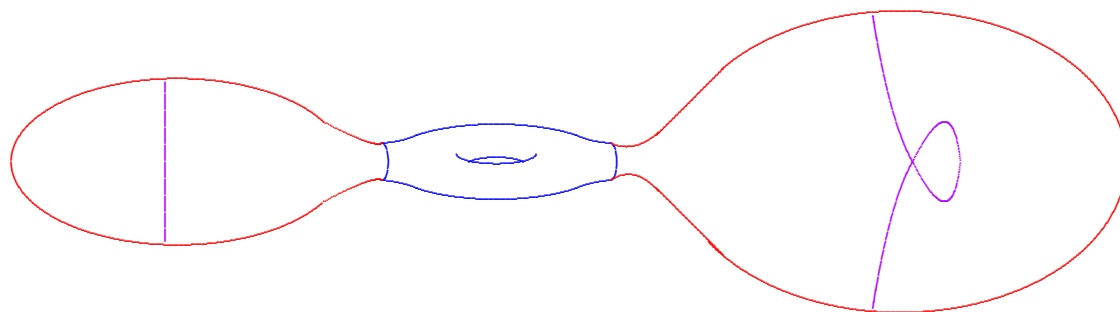

Compactify  $M$  as symplectic 4-manifold  $\widehat{M}$ .

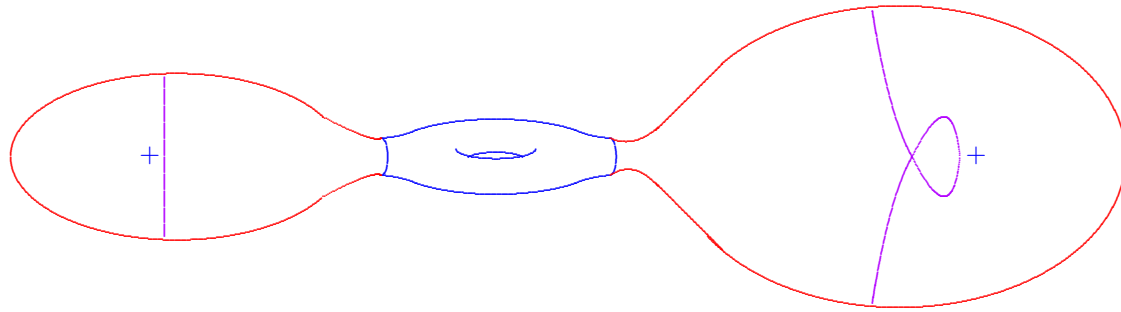

Compactify  $M$  as symplectic 4-manifold  $\widehat{M}$ .

Each end-plug contains immersed symplectic 2-sphere of positive normal bundle.

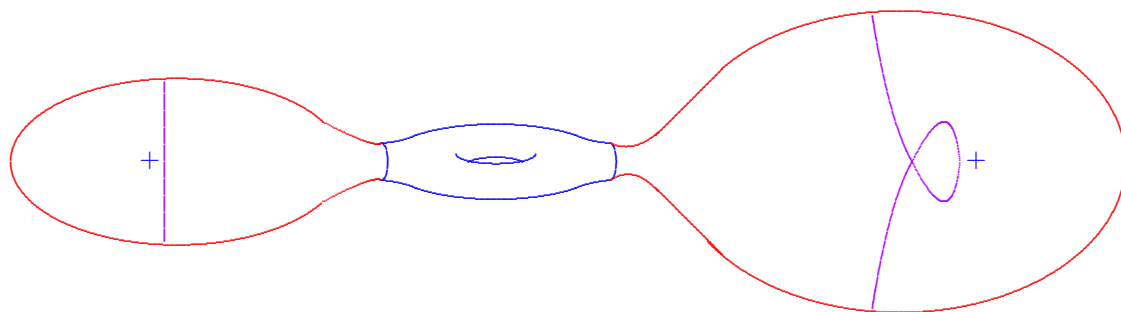

Compactify  $M$  as symplectic 4-manifold  $\widehat{M}$ .

Each end-plug contains immersed symplectic 2-sphere of positive normal bundle.

McDuff  $\implies \widehat{M} \approx$  rational complex surface.

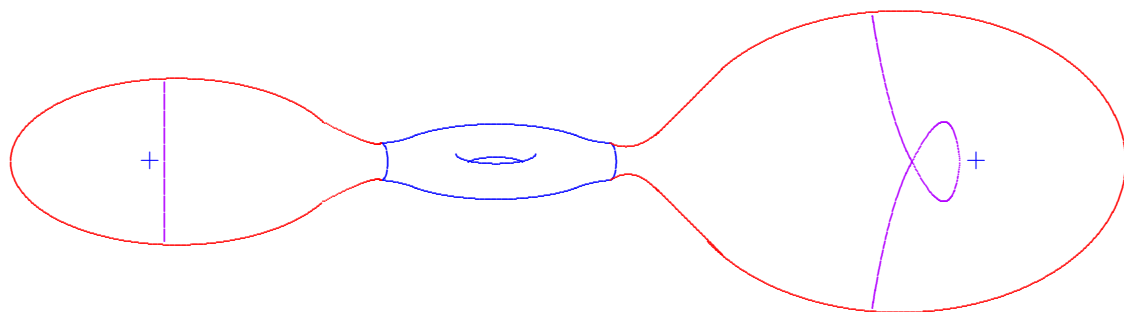

Compactify  $M$  as symplectic 4-manifold  $\widehat{M}$ .

Each end-plug contains immersed symplectic 2-sphere of positive normal bundle.

McDuff  $\implies$  intersection form  $(+- \cdots -)$ .



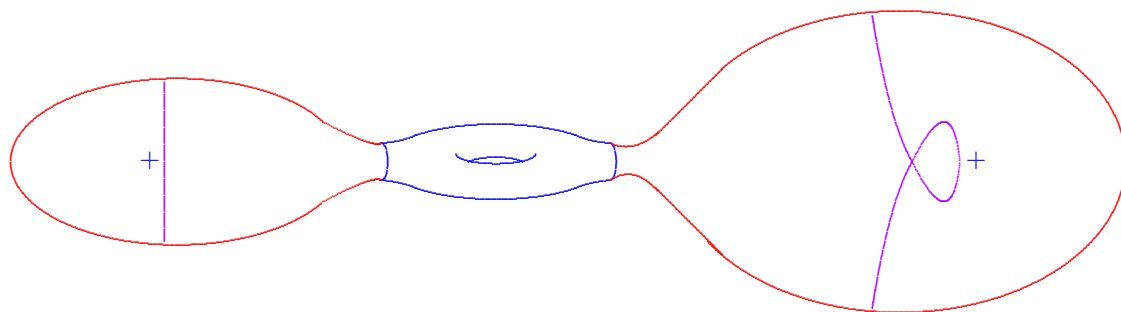

Compactify  $M$  as symplectic 4-manifold  $\widehat{M}$ .

Each end-plug contains immersed symplectic 2-sphere of positive normal bundle.

McDuff  $\implies b_+(M) = 1$ .

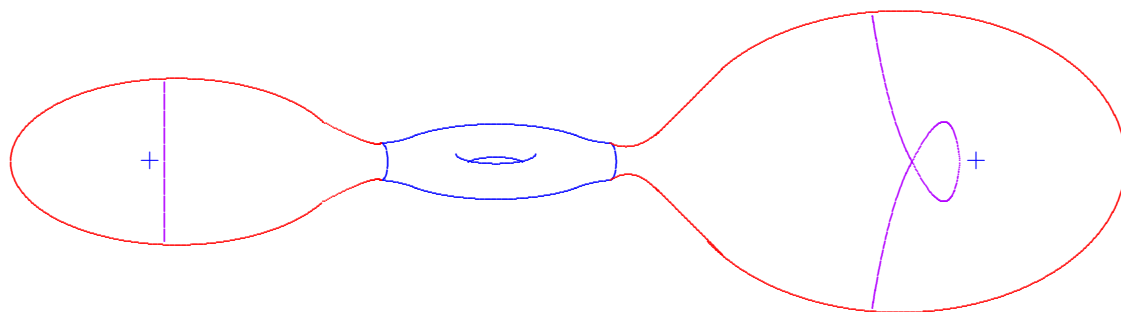

Compactify  $M$  as symplectic 4-manifold  $\widehat{M}$ .

Each end-plug contains immersed symplectic 2-sphere of positive normal bundle.

McDuff  $\implies b_+(M) = 1$ .

Since each end contributes positive direction...

**Lemma.** *Any ALE Kähler manifold has only one end.*

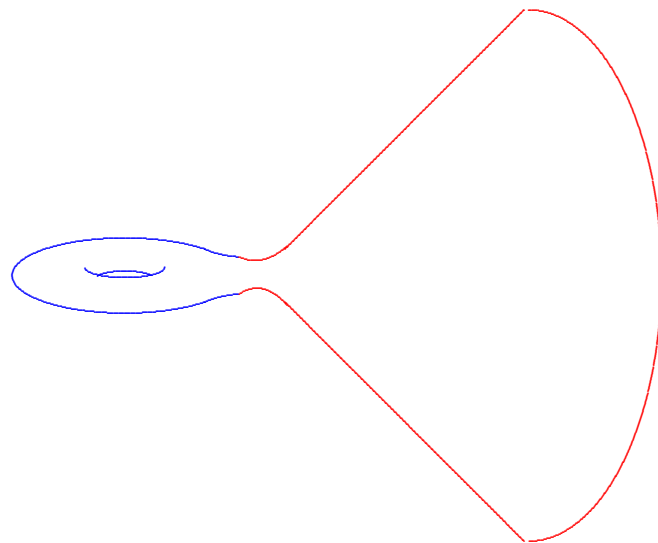

**Lemma.** *Any ALE Kähler manifold has only one end.*

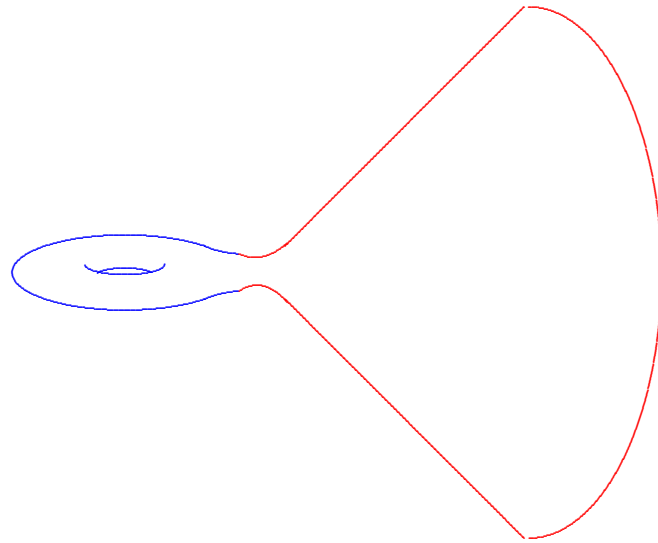

[In higher dimensions, one similarly shows that  $(M, J)$  can be compactified as Kähler orbifold. The Hodge theorem on intersection form instead tells one that form on  $H^{1,1}(\widehat{M}, \mathbb{R})$  is of type  $(+ - \cdots -)$ .]

Knowing there is only one end,

Knowing there is only one end,

we can now prove mass formula in general,

Knowing there is only one end,  
we can now prove mass formula in general,  
assuming only Chruściel fall-off.

Knowing there is only one end,  
we can now prove mass formula in general,  
assuming only Chruściel fall-off.

The ideas needed were already in Hein-L.



Knowing there is only one end,  
we can now prove mass formula in general,  
assuming only Chruściel fall-off.

The ideas needed were already in Hein-L.

The following result provides the key...

**Proposition.** *Let  $g$  be a  $C^2$  Kähler metric on  $(\mathbb{R}^{2m} - \mathbf{D}^{2m})/\Gamma$ ,  $m \geq 2$ , where  $\Gamma \subset \mathbf{SO}(2m)$  is some finite group that acts without fixed-points on  $S^{2m-1}$ .*

**Proposition.** *Let  $g$  be a  $C^2$  Kähler metric on  $(\mathbb{R}^{2m} - \mathbf{D}^{2m})/\Gamma$ ,  $m \geq 2$ , where  $\Gamma \subset \mathbf{SO}(2m)$  is some finite group that acts without fixed-points on  $S^{2m-1}$ . In the given asymptotic coordinate system, suppose that  $g$  satisfies the Chućiel fall-off hypothesis*

**Proposition.** *Let  $g$  be a  $C^2$  Kähler metric on  $(\mathbb{R}^{2m} - \mathbf{D}^{2m})/\Gamma$ ,  $m \geq 2$ , where  $\Gamma \subset \mathbf{SO}(2m)$  is some finite group that acts without fixed-points on  $S^{2m-1}$ . In the given asymptotic coordinate system, suppose that  $g$  satisfies the Chućiel fall-off hypothesis*

$$g_{jk} - \delta_{jk} = C_{-(m-1+\varepsilon)}^1, \quad s \in L^1.$$

**Proposition.** *Let  $g$  be a  $C^2$  Kähler metric on  $(\mathbb{R}^{2m} - \mathbf{D}^{2m})/\Gamma$ ,  $m \geq 2$ , where  $\Gamma \subset \mathbf{SO}(2m)$  is some finite group that acts without fixed-points on  $S^{2m-1}$ . In the given asymptotic coordinate system, suppose that  $g$  satisfies the Chućiel fall-off hypothesis*

$$g_{jk} - \delta_{jk} = C_{-(m-1+\varepsilon)}^1, \quad s \in L^1.$$

*Then there is a continuously differentiable 1-form  $\theta$  on  $(\mathbb{R}^{2m} - \mathbf{D}^{2m})/\Gamma$  such that*

**Proposition.** *Let  $g$  be a  $C^2$  Kähler metric on  $(\mathbb{R}^{2m} - \mathbf{D}^{2m})/\Gamma$ ,  $m \geq 2$ , where  $\Gamma \subset \mathbf{SO}(2m)$  is some finite group that acts without fixed-points on  $S^{2m-1}$ . In the given asymptotic coordinate system, suppose that  $g$  satisfies the Chućiel fall-off hypothesis*

$$g_{jk} - \delta_{jk} = C_{-(m-1+\varepsilon)}^1, \quad s \in L^1.$$

*Then there is a continuously differentiable 1-form  $\theta$  on  $(\mathbb{R}^{2m} - \mathbf{D}^{2m})/\Gamma$  such that*

$$d\theta = \rho$$

**Proposition.** *Let  $g$  be a  $C^2$  Kähler metric on  $(\mathbb{R}^{2m} - \mathbf{D}^{2m})/\Gamma$ ,  $m \geq 2$ , where  $\Gamma \subset \mathbf{SO}(2m)$  is some finite group that acts without fixed-points on  $S^{2m-1}$ . In the given asymptotic coordinate system, suppose that  $g$  satisfies the Chućiel fall-off hypothesis*

$$g_{jk} - \delta_{jk} = C_{-(m-1+\varepsilon)}^1, \quad s \in L^1.$$

*Then there is a continuously differentiable 1-form  $\theta$  on  $(\mathbb{R}^{2m} - \mathbf{D}^{2m})/\Gamma$  such that*

$$d\theta = \rho$$

*where  $\rho$  is the Ricci form of  $g$ ,*

**Proposition.** Let  $g$  be a  $C^2$  Kähler metric on  $(\mathbb{R}^{2m} - \mathbf{D}^{2m})/\Gamma$ ,  $m \geq 2$ , where  $\Gamma \subset \mathbf{SO}(2m)$  is some finite group that acts without fixed-points on  $S^{2m-1}$ . In the given asymptotic coordinate system, suppose that  $g$  satisfies the Chućiel fall-off hypothesis

$$g_{jk} - \delta_{jk} = C_{-(m-1+\varepsilon)}^1, \quad s \in L^1.$$

Then there is a continuously differentiable 1-form  $\theta$  on  $(\mathbb{R}^{2m} - \mathbf{D}^{2m})/\Gamma$  such that

$$d\theta = \rho$$

where  $\rho$  is the Ricci form of  $g$ , and such that

$$\int_{S_\varrho/\Gamma} [g_{kj,k} - g_{kk,j}] \mathbf{n}^j d\mathbf{a}_E =$$



**Proposition.** Let  $g$  be a  $C^2$  Kähler metric on  $(\mathbb{R}^{2m} - \mathbf{D}^{2m})/\Gamma$ ,  $m \geq 2$ , where  $\Gamma \subset \mathbf{SO}(2m)$  is some finite group that acts without fixed-points on  $S^{2m-1}$ . In the given asymptotic coordinate system, suppose that  $g$  satisfies the Chućiel fall-off hypothesis

$$g_{jk} - \delta_{jk} = C_{-(m-1+\varepsilon)}^1, \quad s \in L^1.$$

Then there is a continuously differentiable 1-form  $\theta$  on  $(\mathbb{R}^{2m} - \mathbf{D}^{2m})/\Gamma$  such that

$$d\theta = \rho$$

where  $\rho$  is the Ricci form of  $g$ , and such that

$$\int_{S_\varrho/\Gamma} [g_{kj,k} - g_{kk,j}] \mathbf{n}^j d\mathbf{a}_E = \frac{2}{(m-1)!} \int_{S_\varrho/\Gamma} \theta \wedge \omega^{m-1} + O(\varrho^{-2\varepsilon}).$$

Proof is heavily computational.

Proof is heavily computational. Idea:

Proof is heavily computational. Idea:

First rotate coordinates so that  $J \rightarrow J_0$  at  $\infty$ ,  
where  $J_0$  standard complex structure on  $\mathbb{C}^m$ .

Proof is heavily computational. Idea:

First rotate coordinates so that  $J \rightarrow J_0$  at  $\infty$ ,  
where  $J_0$  standard complex structure on  $\mathbb{C}^m$ .

Now consider smooth trivialization of  $\Lambda^{m,0}$  given  
by orthogonal projection of  $dz^1 \wedge \cdots \wedge dz^m$ .

Proof is heavily computational. Idea:

First rotate coordinates so that  $J \rightarrow J_0$  at  $\infty$ ,  
where  $J_0$  standard complex structure on  $\mathbb{C}^m$ .

Now consider smooth trivialization of  $\Lambda^{m,0}$  given  
by orthogonal projection of  $dz^1 \wedge \cdots \wedge dz^m$ .

Let  $\theta$  be imaginary part of Chern connection form  
for  $\Lambda^{m,0}$ , relative to this trivialization.

Proof is heavily computational. Idea:

First rotate coordinates so that  $J \rightarrow J_0$  at  $\infty$ ,  
where  $J_0$  standard complex structure on  $\mathbb{C}^m$ .

Now consider smooth trivialization of  $\Lambda^{m,0}$  given  
by orthogonal projection of  $dz^1 \wedge \cdots \wedge dz^m$ .

Let  $\theta$  be imaginary part of Chern connection form  
for  $\Lambda^{m,0}$ , relative to this trivialization.

Then direct computation shows that

Proof is heavily computational. Idea:

First rotate coordinates so that  $J \rightarrow J_0$  at  $\infty$ ,  
where  $J_0$  standard complex structure on  $\mathbb{C}^m$ .

Now consider smooth trivialization of  $\Lambda^{m,0}$  given  
by orthogonal projection of  $dz^1 \wedge \cdots \wedge dz^m$ .

Let  $\theta$  be imaginary part of Chern connection form  
for  $\Lambda^{m,0}$ , relative to this trivialization.

Then direct computation shows that

$$[g_{kj,k} - g_{kk,j}] \mathbf{n}^j d\mathbf{a}_E = \frac{2}{(m-1)!} \theta \wedge \omega^{m-1} + d\Omega + O(\varrho^{-2m-1-2\varepsilon})$$



Proof is heavily computational. Idea:

First rotate coordinates so that  $J \rightarrow J_0$  at  $\infty$ ,  
where  $J_0$  standard complex structure on  $\mathbb{C}^m$ .

Now consider smooth trivialization of  $\Lambda^{m,0}$  given  
by orthogonal projection of  $dz^1 \wedge \cdots \wedge dz^m$ .

Let  $\theta$  be imaginary part of Chern connection form  
for  $\Lambda^{m,0}$ , relative to this trivialization.

Then direct computation shows that

$$[g_{kj,k} - g_{kk,j}] \mathbf{n}^j d\mathbf{a}_E = \frac{2}{(m-1)!} \theta \wedge \omega^{m-1} + d\Omega + O(\varrho^{-2m-1-2\varepsilon})$$

where

Proof is heavily computational. Idea:

First rotate coordinates so that  $J \rightarrow J_0$  at  $\infty$ ,  
where  $J_0$  standard complex structure on  $\mathbb{C}^m$ .

Now consider smooth trivialization of  $\Lambda^{m,0}$  given  
by orthogonal projection of  $dz^1 \wedge \cdots \wedge dz^m$ .

Let  $\theta$  be imaginary part of Chern connection form  
for  $\Lambda^{m,0}$ , relative to this trivialization.

Then direct computation shows that

$$[g_{kj,k} - g_{kk,j}] \mathbf{n}^j d\mathbf{a}_E = \frac{2}{(m-1)!} \theta \wedge \omega^{m-1} + d\Omega + O(\varrho^{-2m-1-2\varepsilon})$$

where

$$\Omega = \delta \star \Im m \omega_{J_0}^{2,0}.$$

Proof is heavily computational. Idea:

First rotate coordinates so that  $J \rightarrow J_0$  at  $\infty$ , where  $J_0$  standard complex structure on  $\mathbb{C}^m$ .

Now consider smooth trivialization of  $\Lambda^{m,0}$  given by orthogonal projection of  $dz^1 \wedge \cdots \wedge dz^m$ .

Let  $\theta$  be imaginary part of Chern connection form for  $\Lambda^{m,0}$ , relative to this trivialization.

Then direct computation shows that

$$[g_{kj,k} - g_{kk,j}] \mathbf{n}^j d\mathbf{a}_E = \frac{2}{(m-1)!} \theta \wedge \omega^{m-1} + d\Omega + O(\varrho^{-2m-1-2\varepsilon})$$

where

$$\Omega = 8 \star \Im m \omega_{J_0}^{2,0}.$$

Integrating on  $S_\varrho/\Gamma$  therefore yields:

Proof is heavily computational. Idea:

First rotate coordinates so that  $J \rightarrow J_0$  at  $\infty$ ,  
 where  $J_0$  standard complex structure on  $\mathbb{C}^m$ .

Now consider smooth trivialization of  $\Lambda^{m,0}$  given  
 by orthogonal projection of  $dz^1 \wedge \cdots \wedge dz^m$ .

Let  $\theta$  be imaginary part of Chern connection form  
 for  $\Lambda^{m,0}$ , relative to this trivialization.

Then direct computation shows that

$$[g_{kj,k} - g_{kk,j}] \mathbf{n}^j d\mathbf{a}_E = \frac{2}{(m-1)!} \theta \wedge \omega^{m-1} + d\Omega + O(\varrho^{-2m-1-2\varepsilon})$$

where

$$\Omega = \delta \star \Im m \omega_{J_0}^{2,0}.$$

$$\int_{S_\varrho/\Gamma} [g_{kj,k} - g_{kk,j}] \mathbf{n}^j d\mathbf{a}_E = \frac{2}{(m-1)!} \int_{S_\varrho/\Gamma} \theta \wedge \omega^{m-1} + O(\varrho^{-2\varepsilon})$$

We'll now deduce the mass formula. . .

$$\int_{S_\varrho/\Gamma} [g_{kj,k} - g_{kk,j}] \mathbf{n}^j d\mathbf{a}_E = \frac{2}{(m-1)!} \int_{S_\varrho/\Gamma} \theta \wedge \omega^{m-1} + O(\varrho^{-2\varepsilon})$$

Let  $f : M \rightarrow \mathbb{R}$  be smooth cut-off function:

Let  $f : M \rightarrow \mathbb{R}$  be smooth cut-off function:

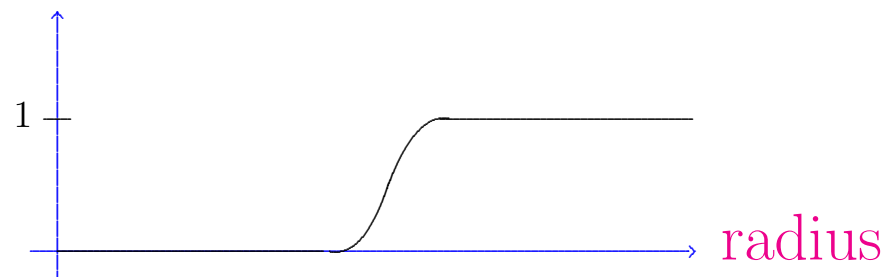

Let  $f : M \rightarrow \mathbb{R}$  be smooth cut-off function:  
 $\equiv 0$  away from end,

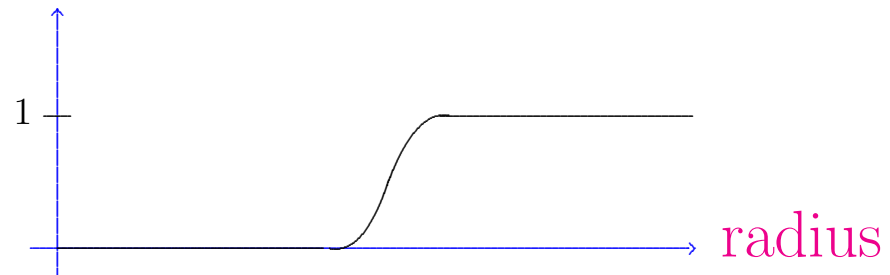



Let  $f : M \rightarrow \mathbb{R}$  be smooth cut-off function:

$\equiv 0$  away from end,

$\equiv 1$  near infinity.

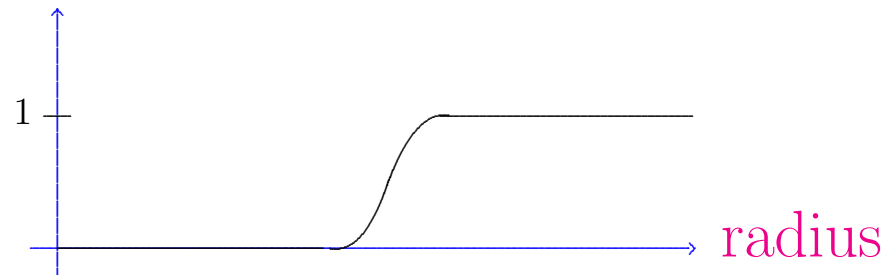

Let  $f : M \rightarrow \mathbb{R}$  be smooth cut-off function:  
 $\equiv 0$  away from end,  
 $\equiv 1$  near infinity.

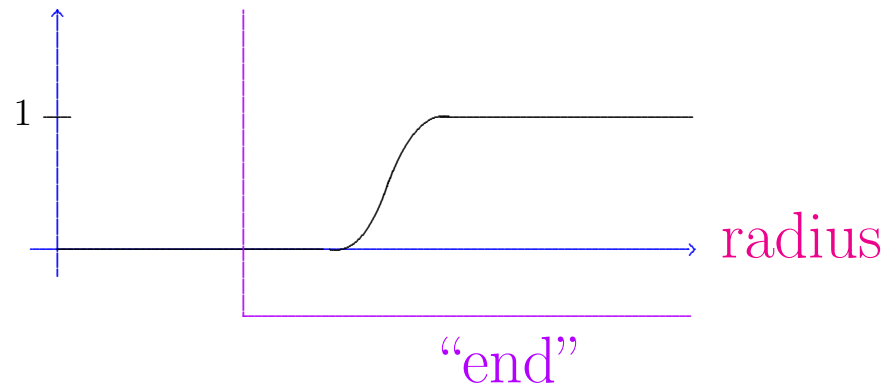

Let  $f : M \rightarrow \mathbb{R}$  be smooth cut-off function:  
 $\equiv 0$  away from end,  
 $\equiv 1$  near infinity.

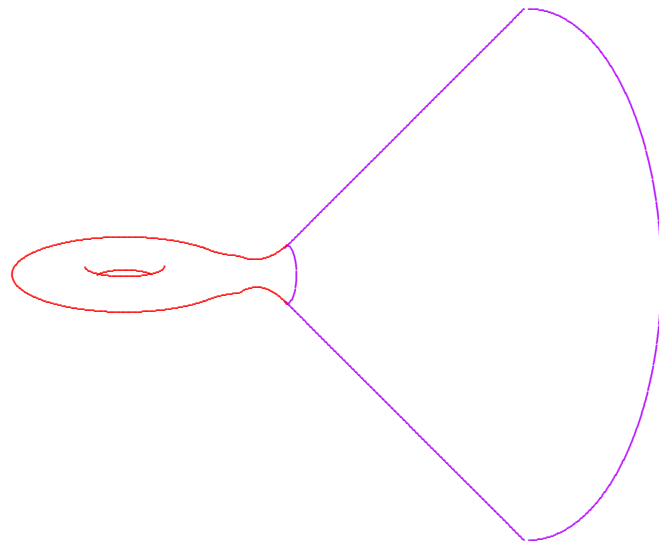
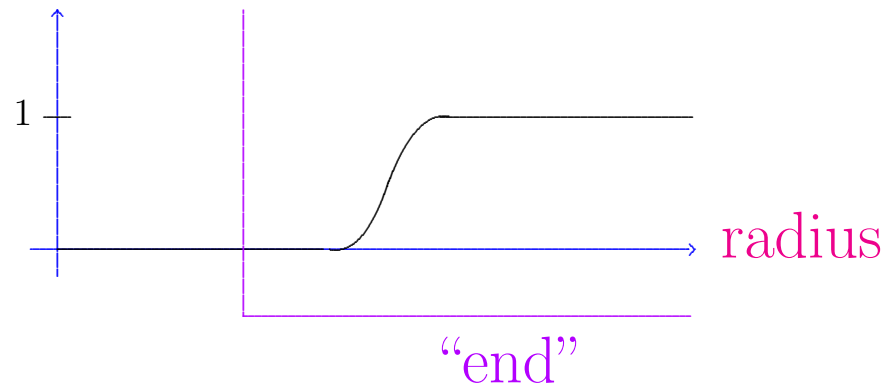

Let  $f : M \rightarrow \mathbb{R}$  be smooth cut-off function:

$\equiv 0$  away from end,

$\equiv 1$  near infinity.

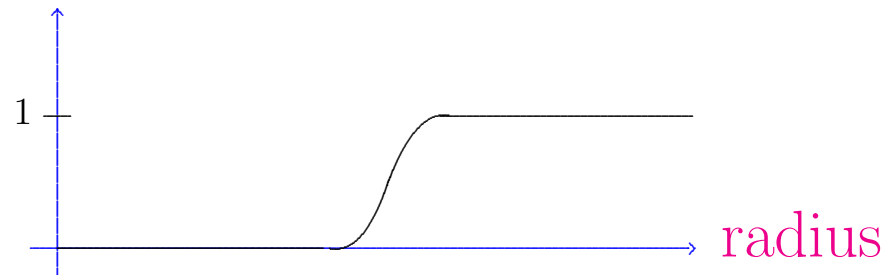

Let  $f : M \rightarrow \mathbb{R}$  be smooth cut-off function:  
 $\equiv 0$  away from end,  
 $\equiv 1$  near infinity.

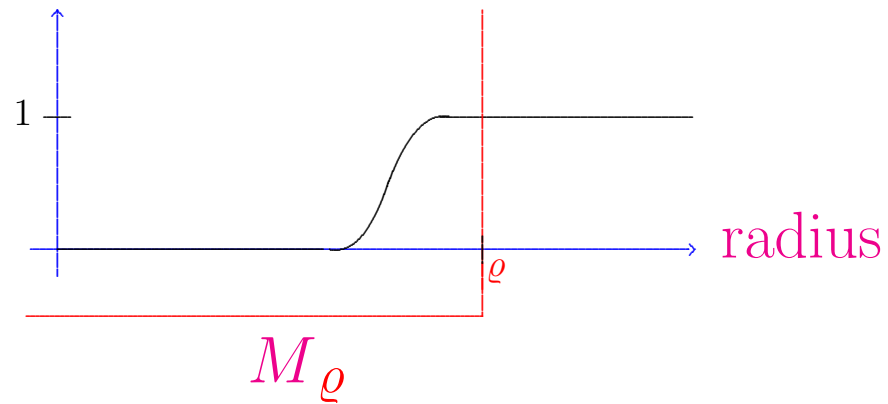

Let  $f : M \rightarrow \mathbb{R}$  be smooth cut-off function:  
 $\equiv 0$  away from end,  
 $\equiv 1$  near infinity.

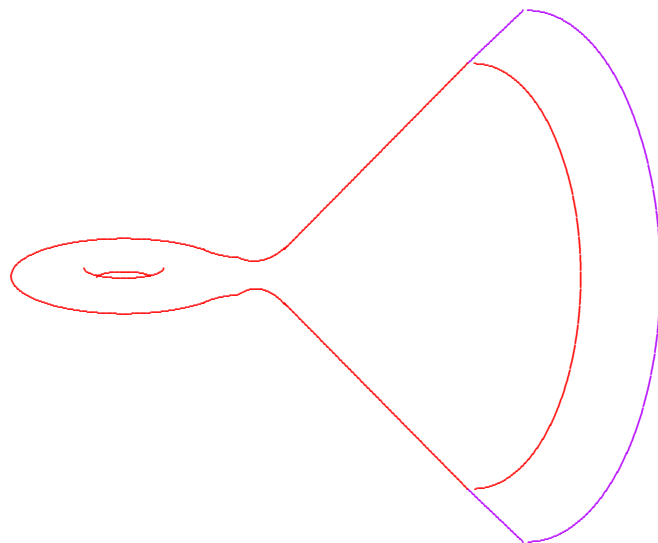
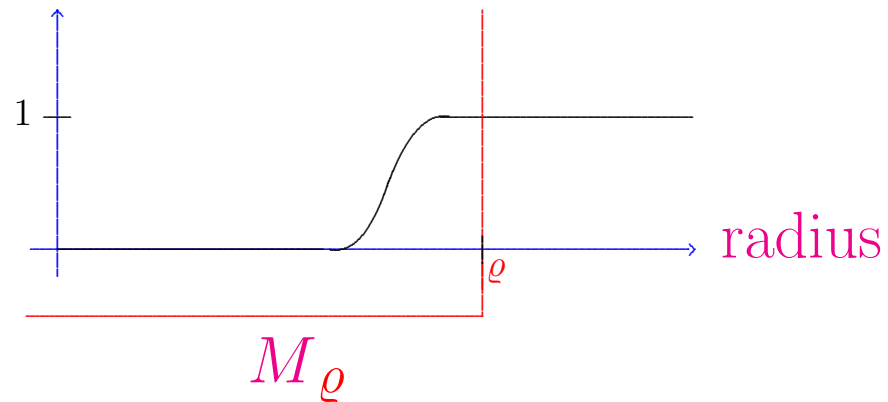

Let  $f : M \rightarrow \mathbb{R}$  be smooth cut-off function:

$\equiv 0$  away from end,

$\equiv 1$  near infinity.

Let  $f : M \rightarrow \mathbb{R}$  be smooth cut-off function:

$\equiv 0$  away from end,

$\equiv 1$  near infinity.

Set

$$\psi := \rho - d(f\theta)$$



Let  $f : M \rightarrow \mathbb{R}$  be smooth cut-off function:  
 $\equiv 0$  away from end,  
 $\equiv 1$  near infinity.

Set

$$\psi := \rho - d(f\theta)$$

Compactly supported, because  $d\theta = \rho$  near infinity.

Let  $f : M \rightarrow \mathbb{R}$  be smooth cut-off function:  
 $\equiv 0$  away from end,  
 $\equiv 1$  near infinity.

Set

$$\psi := \rho - d(f\theta)$$

$$[\psi] = \clubsuit([\rho]) = 2\pi\clubsuit(c_1) \in H_c^2(M)$$

Let  $f : M \rightarrow \mathbb{R}$  be smooth cut-off function:  
 $\equiv 0$  away from end,  
 $\equiv 1$  near infinity.

Set

$$\psi := \rho - d(f\theta)$$

$$[\psi] = \clubsuit([\rho]) = 2\pi\clubsuit(c_1) \in H_c^2(M)$$

$$\langle 2\pi\clubsuit(c_1), [\omega]^{m-1} \rangle = \int_M \psi \wedge \omega^{m-1}$$

Let  $f : M \rightarrow \mathbb{R}$  be smooth cut-off function:  
 $\equiv 0$  away from end,  
 $\equiv 1$  near infinity.

Set

$$\psi := \rho - d(f\theta)$$

$$[\psi] = \clubsuit([\rho]) = 2\pi\clubsuit(c_1) \in H_c^2(M)$$

$$\langle 2\pi\clubsuit(c_1), [\omega]^{m-1} \rangle = \int_{M_\varrho} \psi \wedge \omega^{m-1}$$

where  $M_\varrho$  defined by radius  $\leq \varrho$ .

Let  $f : M \rightarrow \mathbb{R}$  be smooth cut-off function:  
 $\equiv 0$  away from end,  
 $\equiv 1$  near infinity.

Set

$$\psi := \rho - d(f\theta)$$

$$[\psi] = \clubsuit([\rho]) = 2\pi\clubsuit(c_1) \in H_c^2(M)$$

$$\langle 2\pi\clubsuit(c_1), [\omega]^{m-1} \rangle = \int_{M_\varrho} \psi \wedge \omega^{m-1}$$

Let  $f : M \rightarrow \mathbb{R}$  be smooth cut-off function:  
 $\equiv 0$  away from end,  
 $\equiv 1$  near infinity.

Set

$$\psi := \rho - d(f\theta)$$

$$[\psi] = \clubsuit([\rho]) = 2\pi\clubsuit(c_1) \in H_c^2(M)$$

$$\langle 2\pi\clubsuit(c_1), [\omega]^{m-1} \rangle = \int_{M_\varrho} [\rho - d(f\theta)] \wedge \omega^{m-1}$$

Let  $f : M \rightarrow \mathbb{R}$  be smooth cut-off function:

$\equiv 0$  away from end,

$\equiv 1$  near infinity.

Set

$$\psi := \rho - d(f\theta)$$

$$[\psi] = \clubsuit([\rho]) = 2\pi\clubsuit(c_1) \in H_c^2(M)$$

$$\langle 2\pi\clubsuit(c_1), [\omega]^{m-1} \rangle = \int_{M_\varrho} \rho \wedge \omega^{m-1} - \int_{M_\varrho} d(f\theta) \wedge \omega^{m-1}$$

Let  $f : M \rightarrow \mathbb{R}$  be smooth cut-off function:  
 $\equiv 0$  away from end,  
 $\equiv 1$  near infinity.

Set

$$\psi := \rho - d(f\theta)$$

$$[\psi] = \clubsuit([\rho]) = 2\pi\clubsuit(c_1) \in H_c^2(M)$$

$$\langle 2\pi\clubsuit(c_1), [\omega]^{m-1} \rangle = \frac{(m-1)!}{2} \int_{M_\varrho} s \, d\mu - \int_{M_\varrho} d(f\theta \wedge \omega^{m-1})$$



Let  $f : M \rightarrow \mathbb{R}$  be smooth cut-off function:  
 $\equiv 0$  away from end,  
 $\equiv 1$  near infinity.

Set

$$\psi := \rho - d(f\theta)$$

$$[\psi] = \clubsuit([\rho]) = 2\pi\clubsuit(c_1) \in H_c^2(M)$$

$$\langle 2\pi\clubsuit(c_1), [\omega]^{m-1} \rangle = \frac{(m-1)!}{2} \int_{M_\varrho} s \, d\mu - \int_{\partial M_\varrho} f\theta \wedge \omega^{m-1}$$

by Stokes' theorem.

Let  $f : M \rightarrow \mathbb{R}$  be smooth cut-off function:  
 $\equiv 0$  away from end,  
 $\equiv 1$  near infinity.

Set

$$\psi := \rho - d(f\theta)$$

$$[\psi] = \clubsuit([\rho]) = 2\pi\clubsuit(c_1) \in H_c^2(M)$$

$$\langle 2\pi\clubsuit(c_1), [\omega]^{m-1} \rangle = \frac{(m-1)!}{2} \int_{M_\varrho} s \, d\mu - \int_{\partial M_\varrho} \theta \wedge \omega^{m-1}$$

by Stokes' theorem.

Let  $f : M \rightarrow \mathbb{R}$  be smooth cut-off function:  
 $\equiv 0$  away from end,  
 $\equiv 1$  near infinity.

Set

$$\psi := \rho - d(f\theta)$$

$$[\psi] = \clubsuit([\rho]) = 2\pi\clubsuit(c_1) \in H_c^2(M)$$

$$\langle 2\pi\clubsuit(c_1), [\omega]^{m-1} \rangle = \frac{(m-1)!}{2} \int_{M_\varrho} s \, d\mu - \int_{S_\varrho/\Gamma} \theta \wedge \omega^{m-1}$$

because there is only one end!

Let  $f : M \rightarrow \mathbb{R}$  be smooth cut-off function:

$\equiv 0$  away from end,

$\equiv 1$  near infinity.

Set

$$\psi := \rho - d(f\theta)$$

$$[\psi] = \clubsuit([\rho]) = 2\pi\clubsuit(c_1) \in H_c^2(M)$$

$$\int_{S_\varrho/\Gamma} \theta \wedge \omega^{m-1} = -\langle 2\pi\clubsuit(c_1), [\omega]^{m-1} \rangle + \frac{(m-1)!}{2} \int_{M_\varrho} s \, d\mu$$

Let  $f : M \rightarrow \mathbb{R}$  be smooth cut-off function:

$\equiv 0$  away from end,

$\equiv 1$  near infinity.

Set

$$\psi := \rho - d(f\theta)$$

$$[\psi] = \clubsuit([\rho]) = 2\pi \clubsuit(c_1) \in H_c^2(M)$$

$$\frac{2}{(m-1)!} \int_{S_\varrho/\Gamma} \theta \wedge \omega^{m-1} = -\frac{4\pi \langle \clubsuit(c_1), [\omega]^{m-1} \rangle}{(m-1)!} + \int_{M_\varrho} s \, d\mu$$

Let  $f : M \rightarrow \mathbb{R}$  be smooth cut-off function:

$\equiv 0$  away from end,

$\equiv 1$  near infinity.

Set

$$\psi := \rho - d(f\theta)$$

$$[\psi] = \clubsuit([\rho]) = 2\pi \clubsuit(c_1) \in H_c^2(M)$$

$$\int_{S_\varrho/\Gamma} [g_{kj,k} - g_{kk,j}] \mathbf{n}^j d\mathbf{a}_E =$$

$$-\frac{4\pi \langle \clubsuit(c_1), [\omega]^{m-1} \rangle}{(m-1)!} + \int_{M_\varrho} s d\mu + O(\varrho^{-2\varepsilon})$$

Let  $f : M \rightarrow \mathbb{R}$  be smooth cut-off function:

$\equiv 0$  away from end,

$\equiv 1$  near infinity.

Set

$$\psi := \rho - d(f\theta)$$

$$[\psi] = \clubsuit([\rho]) = 2\pi\clubsuit(c_1) \in H_c^2(M)$$

$$\int_{S_\varrho/\Gamma} [g_{kj,k} - g_{kk,j}] \mathbf{n}^j d\mathbf{a}_E =$$

$$-\frac{4\pi \langle \clubsuit(c_1), [\omega]^{m-1} \rangle}{(m-1)!} + \int_{M_\varrho} s d\mu + O(\varrho^{-2\varepsilon})$$

Limit as  $\varrho \rightarrow \infty$  now yields the mass formula.

$$\frac{4\pi^m(2m-1)}{(m-1)!} \mathfrak{m}(M, g) = -\frac{4\pi}{(m-1)!} \langle \clubsuit(c_1), [\omega]^{m-1} \rangle + \int_M s_g d\mu_g$$



$$m(M, g) = -\frac{\langle \clubsuit(c_1), [\omega]^{m-1} \rangle}{(2m-1)\pi^{m-1}} + \frac{(m-1)!}{4(2m-1)\pi^m} \int_M s_g d\mu_g$$

$$m(M, g) = -\frac{\langle \clubsuit(c_1), [\omega]^{m-1} \rangle}{(2m-1)\pi^{m-1}} + \frac{(m-1)!}{4(2m-1)\pi^m} \int_M s_g d\mu_g$$

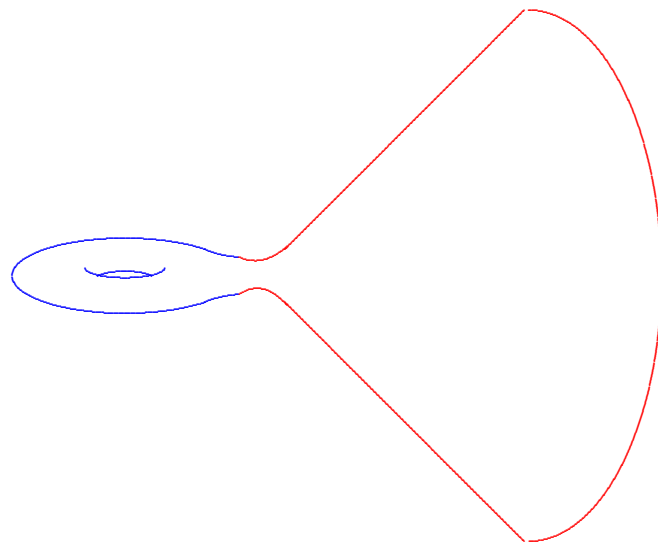

$$m(M, g) = -\frac{\langle \clubsuit(c_1), [\omega]^{m-1} \rangle}{(2m-1)\pi^{m-1}} + \frac{(m-1)!}{4(2m-1)\pi^m} \int_M s_g d\mu_g$$

$$m(M, g) = -\frac{\langle \clubsuit(c_1), [\omega]^{m-1} \rangle}{(2m-1)\pi^{m-1}} + \frac{(m-1)!}{4(2m-1)\pi^m} \int_M s_g d\mu_g$$

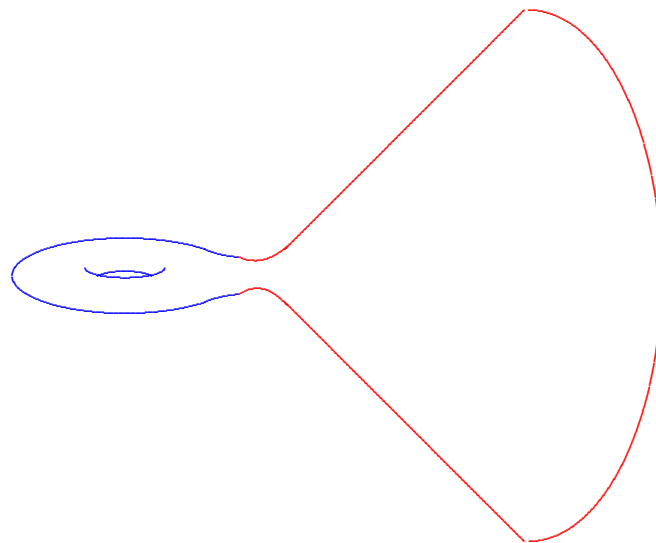

So far, everything has been quite straightforward.

So far, everything has been quite straightforward.

But the Penrose-type inequality is more subtle.

**Theorem E** (Penrose Inequality). *Let  $(M^{2m}, g, J)$  be an **AE** Kähler manifold with scalar curvature  $s \geq 0$ . Then  $(M, J)$  carries a canonical divisor  $D$  that is expressed as a sum  $\sum_j \mathbf{n}_j D_j$  of compact complex hypersurfaces with positive integer coefficients, with the property that  $\bigcup_j D_j \neq \emptyset$  whenever  $M \not\cong \mathbb{R}^{2m}$ . In terms of this divisor, we then have*

$$m(M, g) \geq \frac{(m-1)!}{(2m-1)\pi^{m-1}} \sum \mathbf{n}_j \text{Vol}(D_j)$$

*with  $= \iff (M, g, J)$  is scalar-flat Kähler.*

$$m(M, g) = \frac{\langle \clubsuit(-c_1), [\omega]^{m-1} \rangle}{(2m-1)\pi^{m-1}} + \frac{(m-1)!}{4(2m-1)\pi^m} \int_M s_g d\mu_g$$

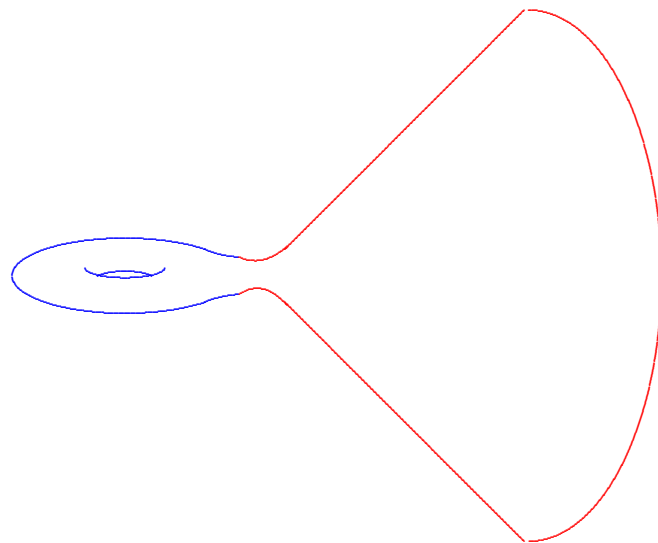



$m = 2 :$

$$m(M, g) = \frac{\langle \clubsuit(-c_1), [\omega] \rangle}{3\pi} + \frac{1}{12\pi} \int_M s_g d\mu_g$$

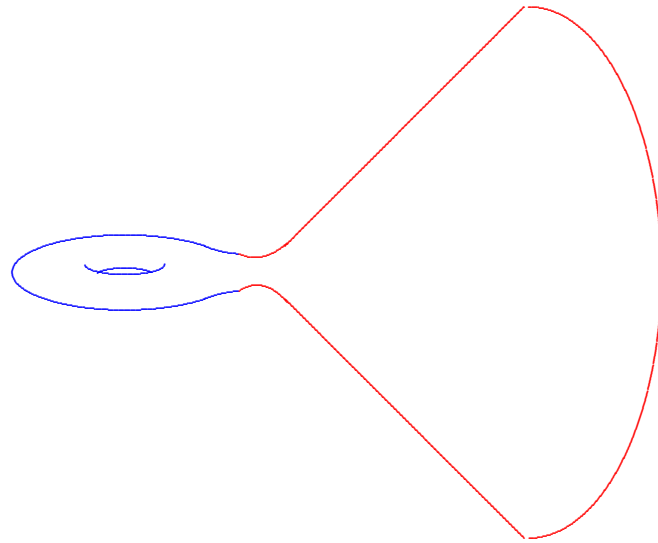

$\exists$  sum of holomorphic curves Poincaré dual to  $-c_1$ :

$\exists$  sum of holomorphic curves Poincaré dual to  $-c_1$ :

Truncate  $(M, \omega)$ , then compactify as symplectic manifold  $(\widehat{M}, \omega)$  by adding  $\mathbb{C}P_2 - B^4$ .

$\exists$  sum of holomorphic curves Poincaré dual to  $-c_1$ :

Truncate  $(M, \omega)$ , then compactify as symplectic manifold  $(\widehat{M}, \omega)$  by adding  $\mathbb{C}P_2 - B^4$ .

This is a symplectic blow-up of  $\mathbb{C}P_2$ .

$\exists$  sum of holomorphic curves Poincaré dual to  $-c_1$ :

Truncate  $(M, \omega)$ , then compactify as symplectic manifold  $(\widehat{M}, \omega)$  by adding  $\mathbb{C}P_2 - B^4$ .

This is a symplectic blow-up of  $\mathbb{C}P_2$ .

For any compatible almost-complex structure, Taubes' results in Seiberg-Witten allow us to find pseudo-holomorphic curves representing blow-ups.

$\exists$  sum of holomorphic curves Poincaré dual to  $-c_1$ :

Truncate  $(M, \omega)$ , then compactify as symplectic manifold  $(\widehat{M}, \omega)$  by adding  $\mathbb{C}P_2 - B^4$ .

This is a symplectic blow-up of  $\mathbb{C}P_2$ .

For any compatible almost-complex structure, Taubes' results in Seiberg-Witten allow us to find pseudo-holomorphic curves representing blow-ups.

Choose almost-complex structure to coincide with integrable  $J$  except in roughly conical asymptotic region and standard neighborhood of line at infinity.

$\exists$  sum of holomorphic curves Poincaré dual to  $-c_1$ :

Truncate  $(M, \omega)$ , then compactify as symplectic manifold  $(\widehat{M}, \omega)$  by adding  $\mathbb{C}P_2 - B^4$ .

This is a symplectic blow-up of  $\mathbb{C}P_2$ .

For any compatible almost-complex structure, Taubes' results in Seiberg-Witten allow us to find pseudo-holomorphic curves representing blow-ups.

Choose almost-complex structure to coincide with integrable  $J$  except in roughly conical asymptotic region and standard neighborhood of line at infinity.

**Technical challenge:** Loss of control of derivatives!

Distance-decreasing map:

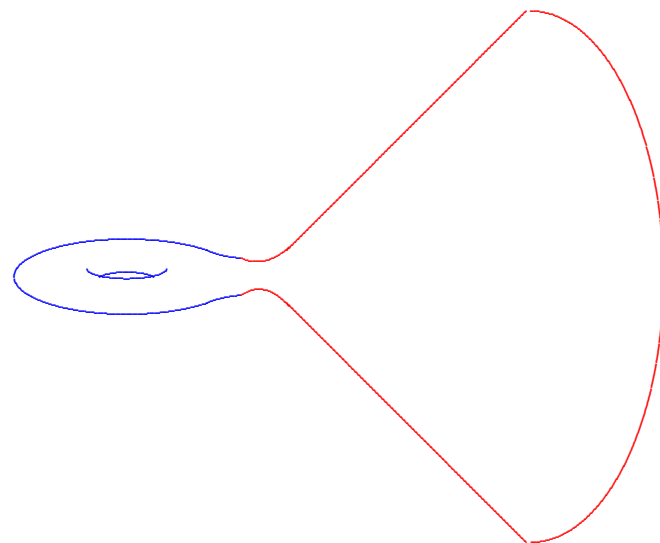



Distance-decreasing map:

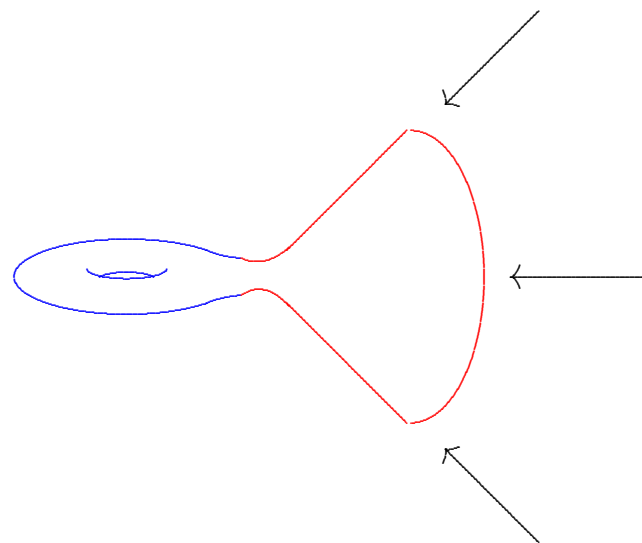

Distance-decreasing map:

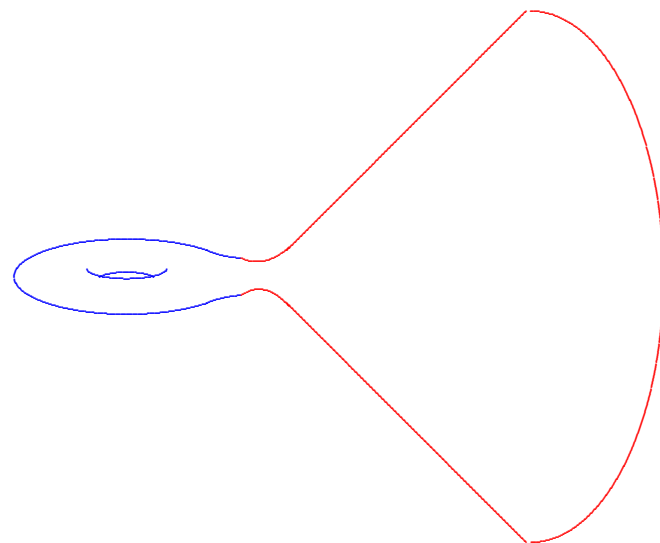

Distance-decreasing map:

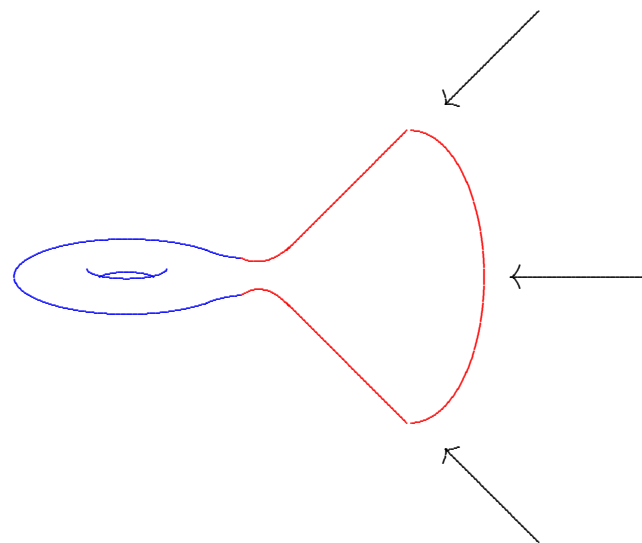

Distance-decreasing map:

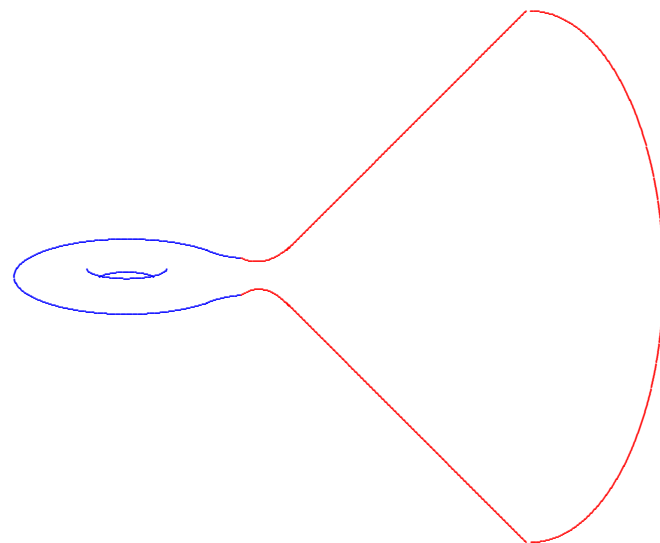

Distance-decreasing map:

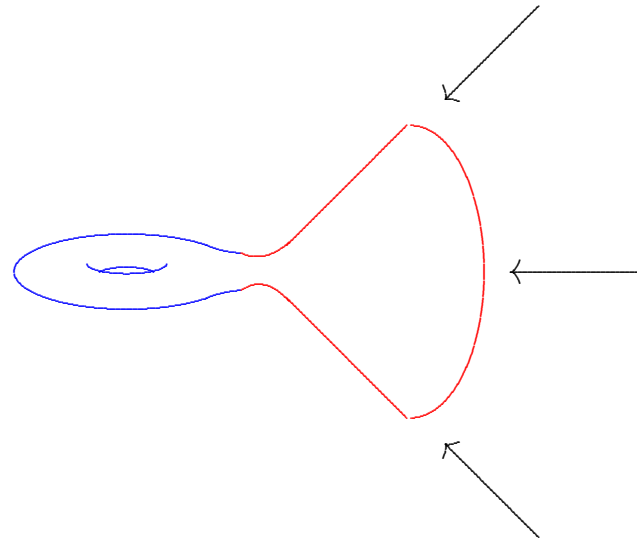

Robust under distortion of metric in outer region.

$\exists$  sum of holomorphic curves Poincaré dual to  $-c_1$ :

Truncate  $(M, \omega)$ , then compactify as symplectic manifold  $(\widehat{M}, \omega)$  by adding  $\mathbb{C}P_2 - B^4$ .

This is a symplectic blow-up of  $\mathbb{C}P_2$ .

For any compatible almost-complex structure, Taubes' results in Seiberg-Witten allow us to find pseudo-holomorphic curves representing blow-ups.

Choose almost-complex structure to coincide with integrable  $J$  except in roughly conical asymptotic region and standard neighborhood of line at infinity.

$\exists$  sum of holomorphic curves Poincaré dual to  $-c_1$ :

Truncate  $(M, \omega)$ , then compactify as symplectic manifold  $(\widehat{M}, \omega)$  by adding  $\mathbb{C}P_2 - B^4$ .

This is a symplectic blow-up of  $\mathbb{C}P_2$ .

For any compatible almost-complex structure, Taubes' results in Seiberg-Witten allow us to find pseudo-holomorphic curves representing blow-ups.

Choose almost-complex structure to coincide with integrable  $J$  except in roughly conical asymptotic region and standard neighborhood of line at infinity.

Calibrated geometry argument then shows that the curves cannot enter asymptotic region, so remain in region where we have original integrable  $J$ .

$\exists$  sum of holomorphic curves Poincaré dual to  $-c_1$ :

Truncate  $(M, \omega)$ , then compactify as symplectic manifold  $(\widehat{M}, \omega)$  by adding  $\mathbb{C}P_2 - B^4$ .

This is a symplectic blow-up of  $\mathbb{C}P_2$ .

For any compatible almost-complex structure, Taubes' results in Seiberg-Witten allow us to find pseudo-holomorphic curves representing blow-ups.

Choose almost-complex structure to coincide with integrable  $J$  except in roughly conical asymptotic region and standard neighborhood of line at infinity.

Calibrated geometry argument then shows that the curves cannot enter asymptotic region, so remain in region where we have original integrable  $J$ .

In  $(M, J)$ , this gives desired Poincaré dual of  $-c_1$ .



$m = 2 :$

$$m(M, g) = \frac{\langle \clubsuit(-c_1), [\omega] \rangle}{3\pi} + \frac{1}{12\pi} \int_M s_g d\mu_g$$

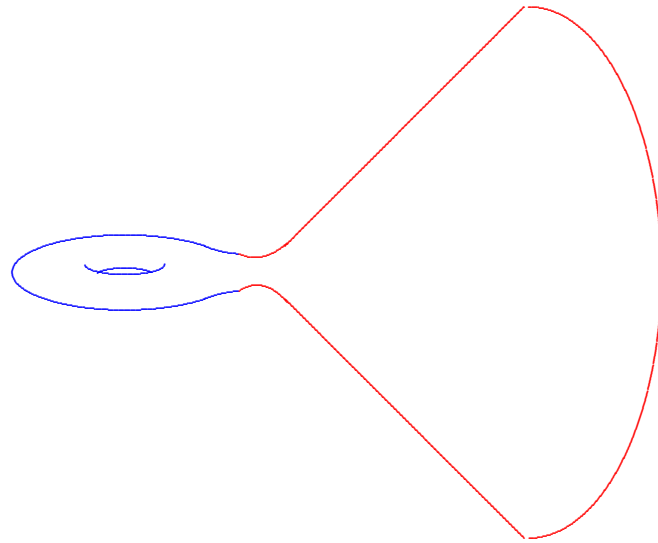

$$m(M, g) = \frac{\langle \clubsuit(-c_1), [\omega]^{m-1} \rangle}{(2m-1)\pi^{m-1}} + \frac{(m-1)!}{4(2m-1)\pi^m} \int_M s_g d\mu_g$$

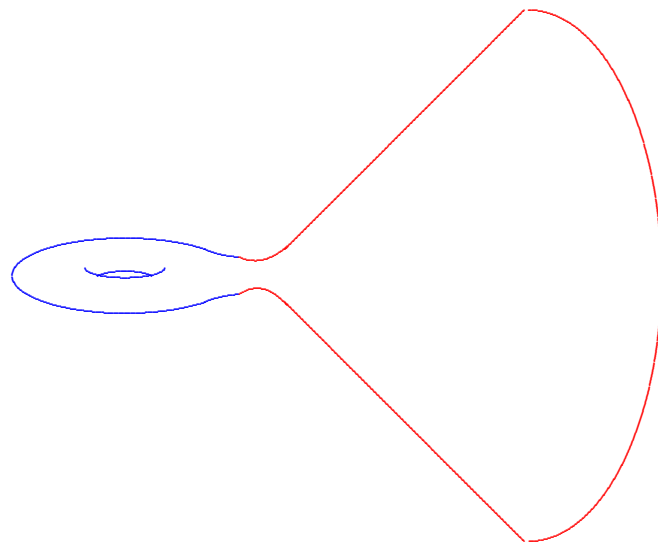

$$m(M, g) = \frac{\langle \clubsuit(-c_1), [\omega]^{m-1} \rangle}{(2m-1)\pi^{m-1}} + \frac{(m-1)!}{4(2m-1)\pi^m} \int_M s_g d\mu_g$$

$$m(M, g) = \frac{\langle \clubsuit(-c_1), [\omega]^{m-1} \rangle}{(2m-1)\pi^{m-1}} + \frac{(m-1)!}{4(2m-1)\pi^m} \int_M s_g d\mu_g$$

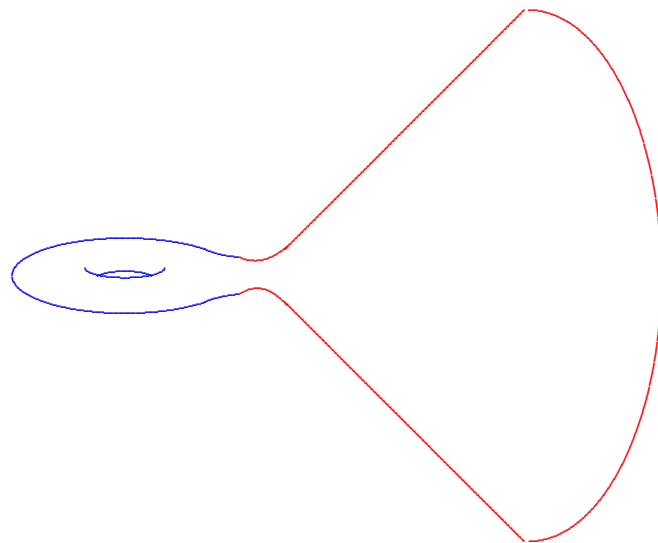

**In fine,**

Infine, vorrei ringraziare gli  
organizzatori,

Infine, vorrei ringraziare gli  
organizzatori, e l'Instituto Nazionale di  
Alta Matematica,

Infine, vorrei ringraziare gli  
organizzatori, e l'Instituto Nazionale di  
Alta Matematica, per avermi invitato!



Infine, vorrei ringraziare gli organizzatori, e l'Instituto Nazionale di Alta Matematica, per avermi invitato!



非常感谢你邀请我!

Fēicháng gǎnxiè nǐ yāoqǐng wǒ!



Infine, vorrei ringraziare gli organizzatori, e l'Instituto Nazionale di Alta Matematica, per avermi invitato!

